

# SHARP®

## COLOUR TELEVISION

MODEL





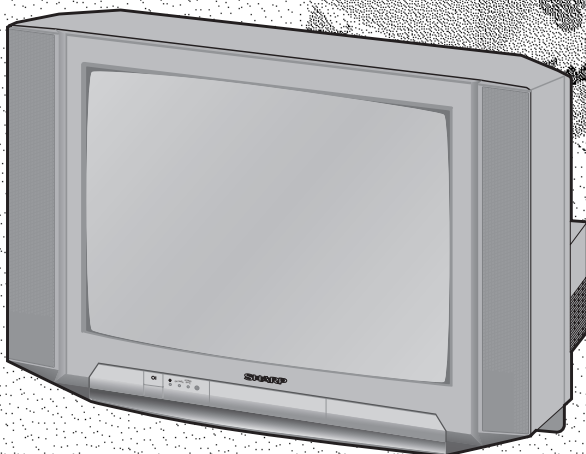



# CX68N5

■ OPERATION MANUAL ■



Please read this operation manual carefully before using the colour television.

# Contents

	<b>Preparation</b>	
	Accessories .....	2
	Easy setup .....	3
	Safety precautions .....	4
	Part names .....	5
	Installing batteries in the remote control unit .....	5
	<b>Watching TV</b>	
	Watching a TV programme .....	7
	Operating the TV buttons .....	8
	<b>Useful features</b>	
	Channel/Timer display .....	9
	Mute .....	9
	AV mode .....	9
	Channel recall .....	10
	TV/Video selection .....	10
	<b>Selecting menu items</b>	
	Selecting a menu item .....	11
	<b>Settings and adjustments</b>	
	On-screen display language selection .....	12
	Manual channel tuning .....	13
	Auto channel tuning .....	14
	Channel setting .....	15
	Picture adjustment .....	16
	Sound adjustment .....	17
	Blue screen .....	18
	Save .....	19
	VM (Velocity Modulation) .....	20
	Off timer .....	21
	On timer .....	22
	Reminder on-screen timer .....	23
	<b>Connections</b>	
	Connecting to a DVD player .....	24
	Watching DVD Playback .....	24
	Connecting to an antenna .....	25
	Connecting to an antenna via a VCR .....	25
	Connecting to video equipment .....	26
	<b>Troubleshooting</b>	
	Troubleshooting .....	27
	<b>Specifications</b>	
	Specifications .....	28

## Dear SHARP Customer

Thank you for buying SHARP's Colour Television. We hope you will have many years of enjoyment from this television set. To ensure proper operation, please read this manual carefully, and keep it in a safe place for future reference.

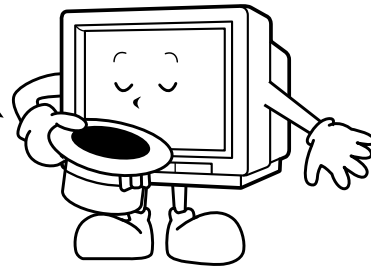

## Accessories

The following accessories are included with this television.

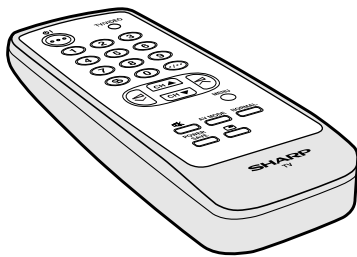

Remote control

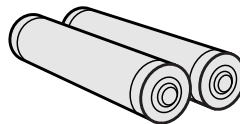

Size-AA batteries

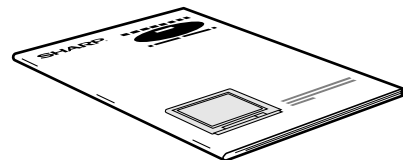

Operation manual



# Easy setup

To use your TV set, perform the easy setup procedure below.

The  mark indicates the page numbers with more detailed information.

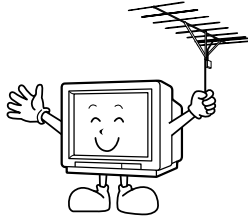
**1**

## Connect the antenna.

- See **25** to connect the antenna.

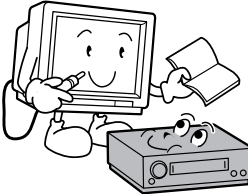
**2**

## Connect any video equipment.

- See **25**, **26** to connect video equipment.
- See the operation manual of your video equipment when connecting to the TV set.

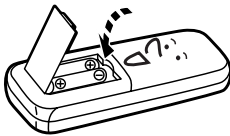
**3**

## Insert the batteries into the remote control.

- Use the two batteries included with the TV.
- See **5**.

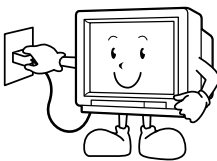
**4**

## Insert the AC plug to the power outlet.

- If you will not use the TV set for a considerable length of time, as a safety precaution, unplug the cord from the outlet.

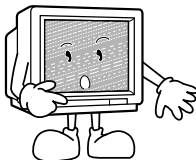





**5**

## Tune the channels.

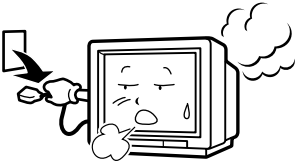
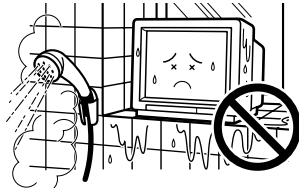
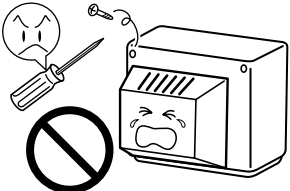
- Use the buttons on the TV.
- See **13**, **14**.

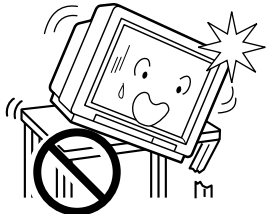
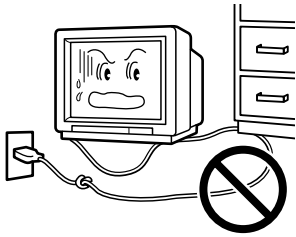

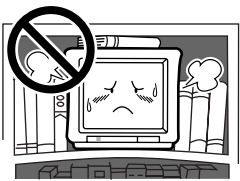
# Safety precautions

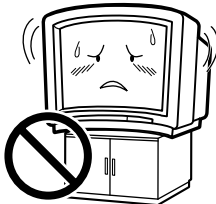
<p><b>Damage</b></p>  <p>Turn off the power and unplug the power cord from the wall outlet immediately if the TV set begins to make any unusual noises or gives off smoke or an unusual smell. Then call your dealer for service.</p>	<p><b>Water</b></p>  <p>To prevent fire or electrical shock, do not place the TV set near a bath, swimming pool or other area where it may become wet.</p>
<p><b>Servicing</b></p>  <p>To reduce the risk of electric shock, do not remove the back of the cabinet. This TV set contains dangerous voltage.</p>	<p><b>Moisture</b></p>  <p>To prevent electrical shock, do not use the TV set in an excessively damp place.</p>
<p><b>Unstable surface and shocks</b></p>  <p>Do not place this TV set on an unstable cart, stand, shelf, or table. The TV set may fall, causing serious injury to a child or adult, and serious damage to the set.</p> <p>Sharp recommends securing the TV set to a stable surface or wall to prevent the set from falling due to sudden shocks or impact.</p>	<p><b>Power-cord protection</b></p>  <p>To prevent electrical shock, do not subject the AC power cord to damage by bending or twisting it, or by placing heavy items on top of it and do not place the AC power cord under the TV set. If the AC power cord becomes damaged, unplug it from the wall outlet immediately and call your dealer for service.</p>
<p><b>Liquid entry</b></p>  <p>Do not place a flower vase or anything else containing liquid on the TV set, as liquid spilt on the TV set can cause electrical shock or failure.</p>	<p><b>Ventilation</b></p>  <p>Do not place this TV set in a confined area, such as on a bookshelf or in a built-in case. Leave adequate space behind the TV for proper ventilation.</p>
<p><b>Object entry</b></p>  <p>Never insert or drop any metallic or inflammable objects into the ventilation openings of the TV set, as this can cause fire, electrical shock, or electrical failure.</p>	<p><b>TV Set position</b></p>  <p>Do place the TV set onto an even stand, table or track which size is bigger than the TV set. If the TV set is put onto a smaller size or uneven stand, table or track may cause the TV cabinet distort. Do not put or insert anything between TV set and the stand, table or track.</p>

# Part names

The **7** mark indicates the page numbers with more detailed information.

## Remote control

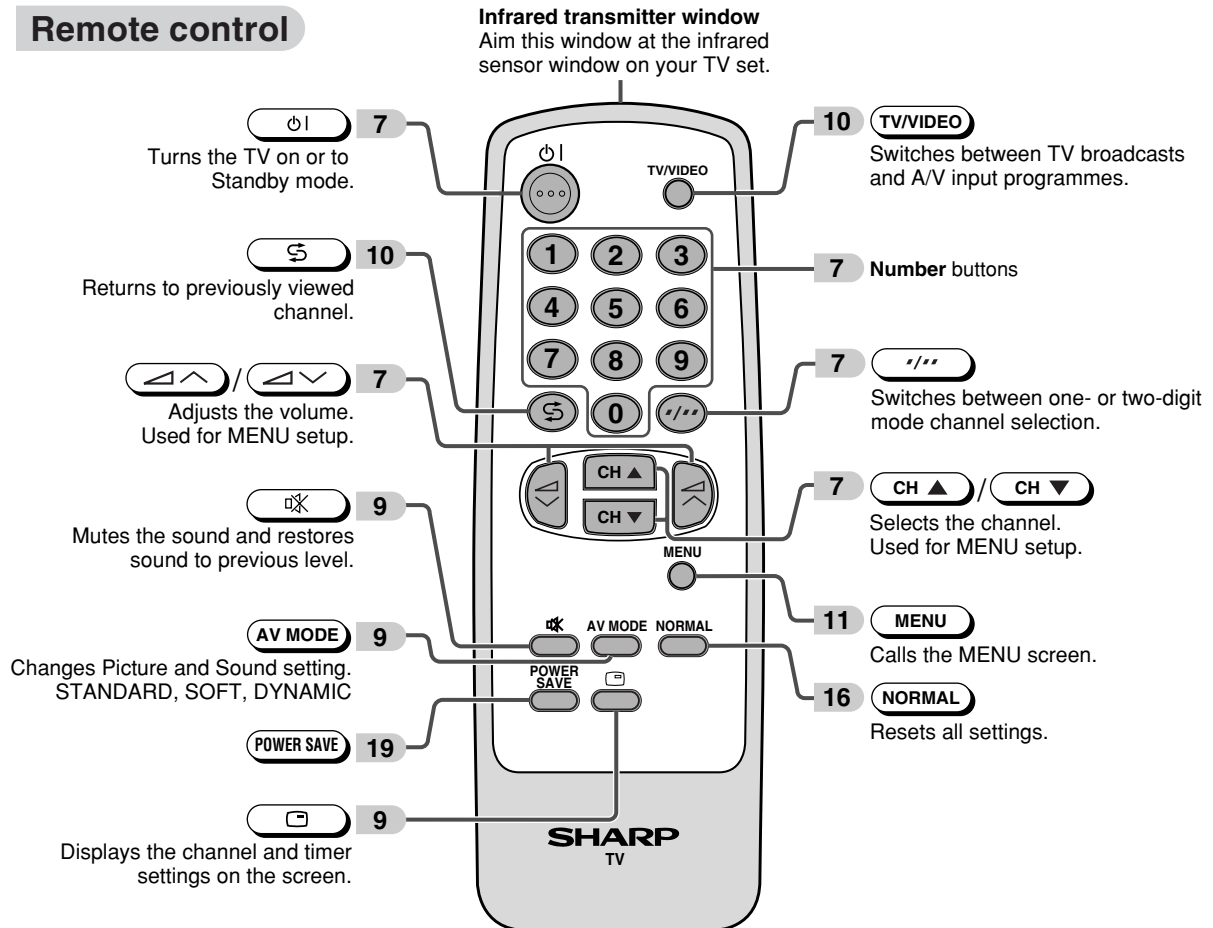

## Installing batteries in the remote control unit

**1** With your thumbnail, pull up at the slit to open the battery cover.

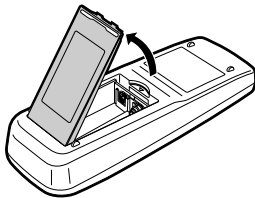

**2** Insert two batteries (size AA).

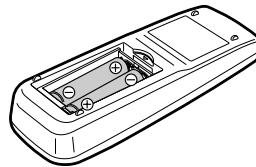

**3** Replace the battery cover.

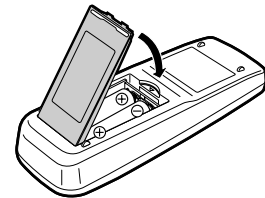

### NOTE

- Be sure to match the battery ⊕/⊖ terminals with the ⊕/⊖ marks inside the compartment.
- Remove the batteries if weak or if the unit is not in use for long periods.
- Do not mix old and new batteries.
- Incorrect installation of the batteries may damage the remote control.



## TV set

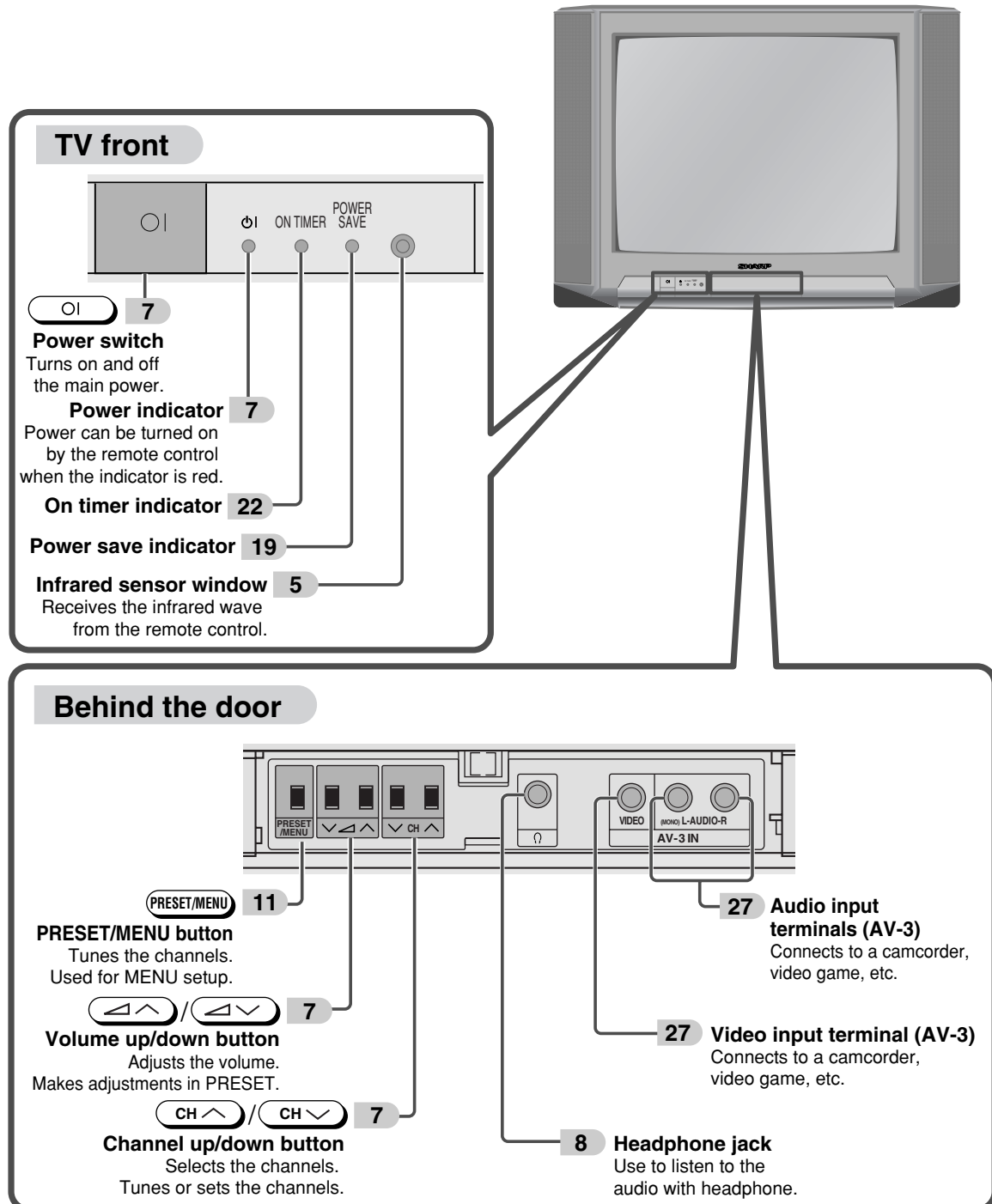

**NOTE** • When using headphone, see **8**.

# Watching TV

## TV Set

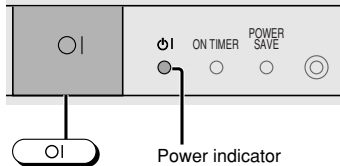

## Behind the door

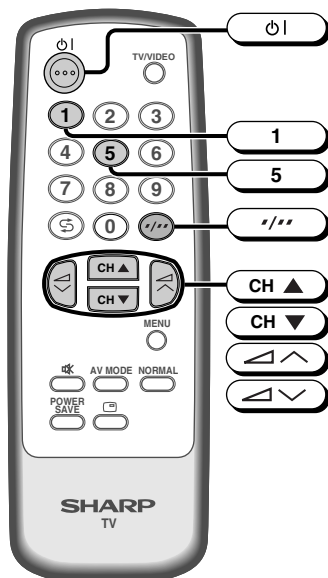
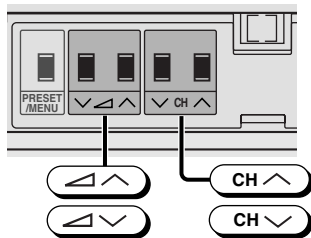

## Watching a TV programme

### Simple operations for watching a TV programme

#### 1 Turn on power.

- When the power indicator is off, press **OI**.
- When the power indicator is red, press **OI** on the remote control. The power indicator changes to green and a picture appears.

#### 2 Select channel.

With **CH ^** / **CH v**

- Press **CH ^** and channels change as shown below.  
1 → 2 → ... → 98 → 99 → AV1 (or SAV1) → AV2 (or COMPONENT) → AV3 → 0 → 1 → 2 ...
- Press **CH v** and channels change as shown below.  
1 → 0 → AV3 → AV2 (or COMPONENT) → AV1 (or SAV1) → 99 → 98 → ... → 2 → 1 → 0 ...

With the number buttons (on remote control)

- To select a one-digit channel, such as 5, press **5**.  
If "5-" is indicated, press **\*/\*\*** to select one-digit input, and then press **5** again.
- To select a two-digit channel, such as 15, press **\*/\*\*** to select the two-digit input. Press **1**, and then press **5**.

#### 3 Adjust volume using **CH ^** / **CH v**.

- The number of oval blocks "●" indicates the volume level. The volume bar disappears approximately three seconds after the volume has been adjusted.

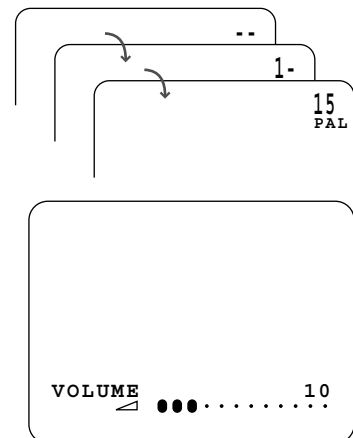

### NOTE

- When the power indicator is red, either **CH ^** / **CH v** on the TV can be pressed to turn on the power.
- The channel number is displayed in green for channels tuned by auto tuning and displayed in yellow for channels tuned using fine tuning.
- When the power indicator is red, the TV is in Standby mode and power is still supplied to the TV. If you will not watch TV for a while, turn off the main power by pressing **OI** on the TV set. Also, if you will not be at home for a considerable length of time, unplug the cord from the outlet.
- The AV1 (or SAV1), AV2 (or COMPONENT) and AV3 input channels cannot be selected using **CH ^** / **CH v** on the remote control. Use **TVVIDEO** to select these channel.
- Channels that have been skipped cannot be selected. See **15**.
- The on-screen displays in this manual may differ from their actual appearance.



## Operating the TV buttons

### Simple operation of the TV set

#### Behind the door

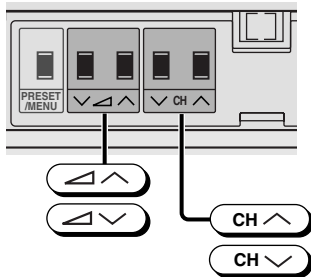

Using  / 

Press  to increase volume.

Press  to decrease volume.

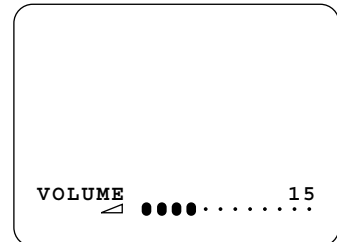

Using  / 

Press  to increase channel number.

Press  to decrease channel number.

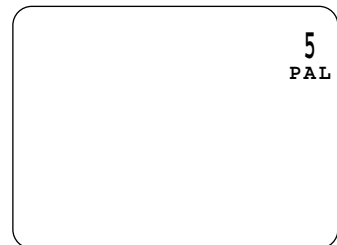

#### Behind the door

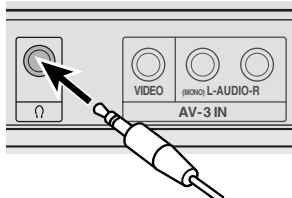

#### Using headphone

Insert headphone plug into headphone jack to listen to audio with headphone.

- The audio from the speakers is turned off.

#### NOTE

- Select an appropriate volume so as not to injure your hearing.
- To avoid injuring your hearing, do not put on the headphone before plugging them into the headphone jack and before the power is turned on.
- The proper impedance for the headphone is 32 ohms.
- Remove the headphone plug from the jack when not using the headphone.

# Useful features

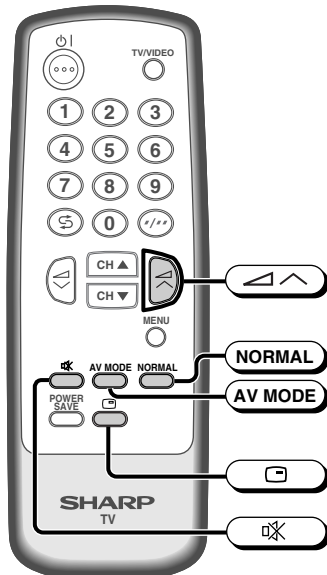

## Channel/Timer display

Displays the current channel number, the timer, and other settings on the screen.



### 1 Press .

- The time remaining on the Off timer, On timer, and Reminder appears on the screen.
- When no Timer is set, the channel number and colour system appear on the screen. Press again to clear these current settings display on the screen.

OFF  2:30  
ON  8:00  
M  1:50

### 2 Press again.

- The channel number and colour system appear on the screen.

5  
PAL

### 3 Press once again.

- The display disappears.

## Mute

Silences the sound.

### 1 Press .

- “” appears on the screen, and the sound is silenced.





### 2 Press again.

- The volume returns to its previous level.

## AV Mode

Each time you press the  button, the mode switches between STANDARD, SOFT and DYNAMIC.

STANDARD: Normal mode  
SOFT: Soft mode  
DYNAMIC: Dynamic mode

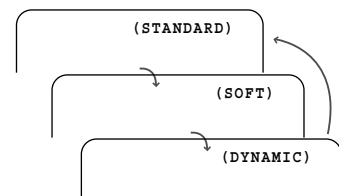

**NOTE** • To return to the original setting (factory setting), press the . For adjusting the Picture and Sound modes, please see **16** and **17**.

- Mute will be cancelled if the  is pressed at anytime.

## Channel recall

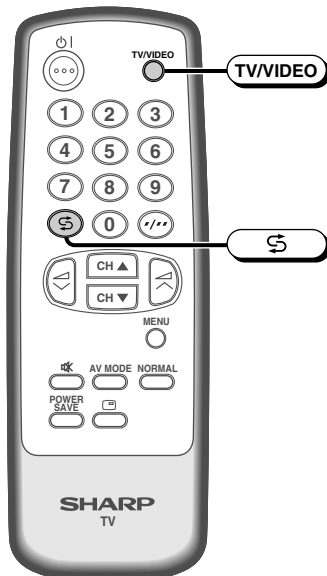

Switches back to the channel you were watching just before the current channel.



Press .

- The channel previously viewed returns to the screen.

### Example:

After switching from channel 5 to channel 7,  is pressed, the channel will change to channel 5. Press  again to return to channel 7.

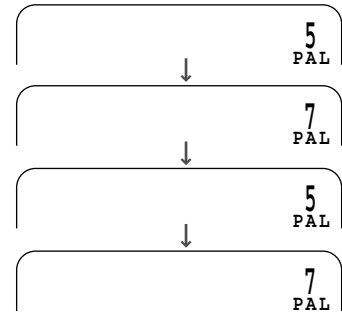

## TV/Video selection

Switches between TV broadcasts and AV input programmes.

Each time you press the , the input switches between AV1 (or SAV1), AV2 (or COMPONENT), AV3 and TV programme.

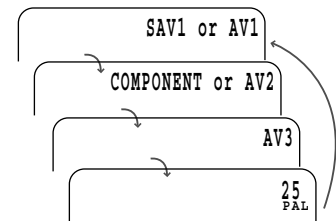

# Selecting menu items

This TV set allows you to adjust the picture and sound, and set the channels and other features using the On-screen display with the remote control or from the TV set. Select the desired menu item by following the steps below and then refer to the indicated page for details.

## Remote control

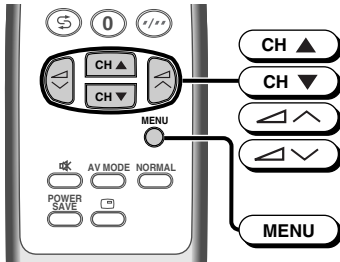

## Behind the door

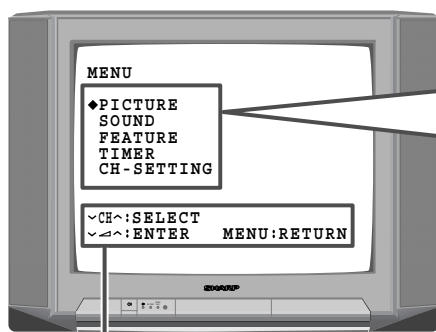
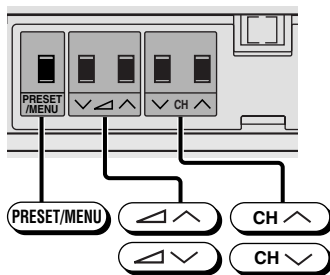

Operating guide

## Selecting a menu item

**1** Press **MENU** / **PRESET/MENU** to call MENU screen.

```
MENU
◆PICTURE
SOUND
FEATURE
TIMER
CH-SETTING
```

**2** Press **CH ▲** / **CH ▼** or **CH ▲** / **CH ▼** to select desired menu item.

- The selected item is highlighted in yellow.

```
MENU
PICTURE
◆SOUND
FEATURE
TIMER
CH-SETTING
```

**3** Press **↵** / **↵** to enter.

- The corresponding menu screen will appear.

```
SOUND (STANDARD)
◆SURROUND ON
TREBLE +10
BASS -20
BALANCE D20
```

<p>PICTURE menu..... 16</p> <pre>PICTURE (STANDARD) ◆CONTRAST 10 COLOUR 0 BRIGHTNESS +10 TINT SHARPNESS -10 PICTURE NR ON WHITE TEMP ◆20 ~CH^:SELECT ~&lt;^:ADJUST MENU:RETURN</pre>	<p>SOUND menu..... 17</p> <pre>SOUND (STANDARD) ◆SURROUND ON TREBLE +10 BASS -20 BALANCE D20 ~CH^:SELECT ~&lt;^:ADJUST MENU:RETURN</pre>
<p>FEATURE menu... 18 - 20</p> <pre>FEATURE ◆BLUE BACK ON SAVE ON VM ON ~CH^:SELECT ~&lt;^:ADJUST MENU:RETURN</pre>	<p>TIMER menu..... 21 - 23</p> <pre>TIMER ◆OFF [ ] --:-- ON [ ] --:-- POSITION VOLUME E --:-- ~CH^:SELECT ~&lt;^:ADJUST MENU:RETURN</pre>
<p>CH-SETTING menu..... 15</p> <pre>CH-SETTING ◆POSITION CH27 COLOUR AUTO SKIP OFF FINE 168.25MHz ~CH^:SELECT ~&lt;^:ADJUST MENU:RETURN</pre>	

### NOTE

- If you press **PRESET/MENU** on TV set for more than two seconds, the LANGUAGE mode screen will appear instead of the MENU screen. To display the MENU screen, press **PRESET/MENU** until the normal screen appears, then press the button again.
- The procedures for setting and selecting the menu items on the following pages are described using the buttons on the remote control. These procedures can also be performed using the corresponding buttons on the TV set.

# Settings and adjustments

## On-screen display language selection

The on-screen display language can be set to English, Chinese, French, Russian, Malay or Arabic.

### Behind the door

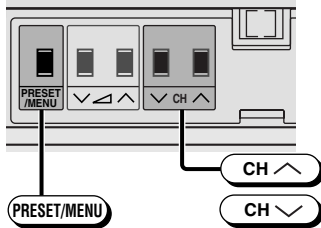

### TV set

**1** Press **PRESET/MENU** for more than two seconds.

**2** Press **CH ^** / **CH v** to select desired language.

- Pressing **PRESET/MENU** changes the screen as shown below.

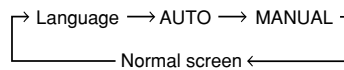

**3** Press **PRESET/MENU** until normal screen appears.

◆ENGLISH  
 中文  
 FRANCAIS  
 РУССКИЙ  
 BAHASA MELAYU  
 العربية

## Settings and adjustments

### Manual channel tuning

Enables manual channel tuning to a desired TV station. (e.g. tuning the TV to a VCR, tuning in an additional TV station.)  
**NOTE:** This TV is already tuned into 2, 7, 9, 10 and 28.

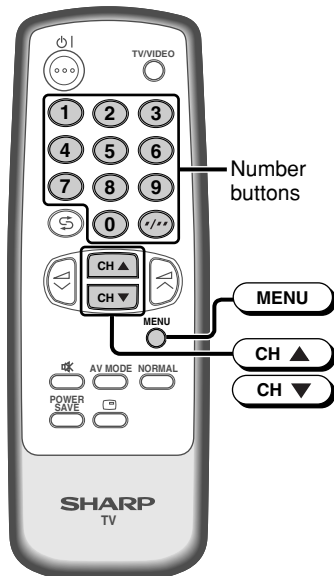

#### Behind the door

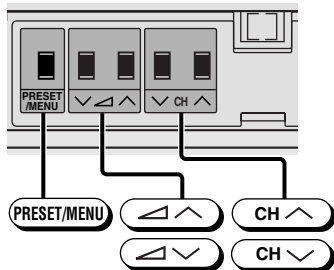

- 1** Press **PRESET/MENU** for more than two seconds. The language select mode appears.

◆ENGLISH  
 中文  
 FRANCAIS  
 РУССКИЙ  
 BAHASA MELAYU  
 العربية

- 2** Press **PRESET/MENU** twice to display **MANUAL** mode screen.

- Pressing **PRESET/MENU** changes the screen as shown below.

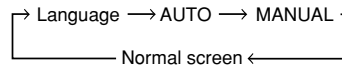

MANUAL (B/G)  
 VHF 1  
 48.25MHz

- 3** Press **CH ▲** / **CH ▼** or **CH ▲** / **CH ▼** or number buttons to select channel position.

MANUAL (B/G)  
 VHF 5  
 107.50MHz

- 4** Press **▲** / **▼** on TV set to locate channel you wish to preset to current channel position.

- Search is initiated and when a TV signal is received during the search, the search stops.

Channel position

- 5** Repeat steps 3 and 4 above, to preset channel positions for other broadcasts.

- 6** Press **PRESET/MENU** again to display normal screen.



## Auto channel tuning

Automatically tunes in and presets receivable TV stations, using consecutive channels numbers (e.g. 2, 7, 9, 10 will be stored as 1, 2, 3, 4).

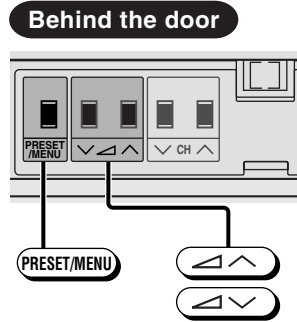

- 1** Press **PRESET/MENU** for more than two seconds. The language select mode appears.

◆ENGLISH  
中文  
FRANCAIS  
РУССКИЙ  
BAHASA MELAYU  
العربية

- 2** Press **PRESET/MENU** again to display **AUTO** mode screen.

- Pressing **PRESET/MENU** changes the screen as shown below.

→ Language → AUTO → MANUAL  
← Normal screen ←

AUTO (B/G)  
VHF 1  
48.25MHz

- 3** Press **▲▲** / **▲▼** on TV set.

- All the TV stations in your area that can be received by the TV set are automatically preset between channels 1 to 99.
- The screen shows whatever is on channel 1 when auto channel preset is finished.

1  
PAL

### NOTE

- AUTO PRESET stores all receivable channels including those which may be very weak and not clearly visible. To preset only those channels designated for the local viewing region, use MANUAL PRESET. See **13**.
- Unused channels are automatically skipped.

## Settings and adjustments

### Channel setting

Enables individual channel setting.

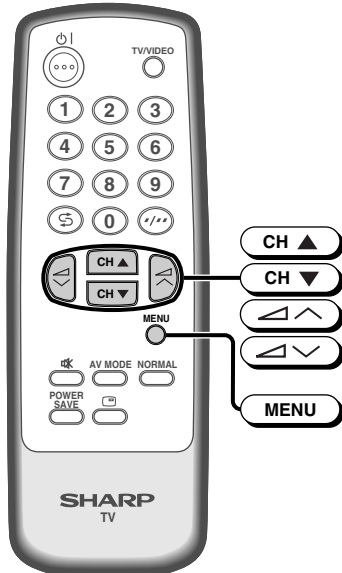

**1** Press **MENU** to call MENU screen.

**2** Press **CH ▲** / **CH ▼** to select "CH-SETTING".

```
MENU
PICTURE
SOUND
FEATURE
TIMER
◆CH-SETTING
```

**3** Press **▲▲** / **▼▼** to display CH-SETTING menu.

**4** Press **CH ▲** / **CH ▼** to select desired setting.

```
CH-SETTING
◆POSITION      CH27
COLOUR        AUTO
SKIP          OFF
FINE          168.25MHz
```

**5** Each time you press **▲▲** / **▼▼**, setting for individual items changes as follows:

- **POSITION**  
The channel position changes to the higher or lower number.
- **COLOUR**  
AUTO ↔ PAL
- **SKIP**  
ON ↔ OFF  
Channel numbers with a "■" mark on the left are set to SKIP. To turn off SKIP, press the number buttons to select the desired channel and then set "SKIP" to "OFF".
- **FINE**  
The frequency changes to allow fine tuning.

```
~CH~:SELECT
~▲~:ADJUST  MENU:RETURN
```

**6** Press **MENU** until normal screen appears.

- When you select AV1, AV2 or AV3 for the channel position, the CH-SETTING menu changes as shown on the right and the colour mode changes in the following order:

```
CH-SETTING
◆POSITION      AV1
COLOUR        AUTO
```

```
~CH~:SELECT
~▲~:ADJUST  MENU:RETURN
```

→AUTO ↔ PAL ↔ N443 ↔ N358 ←

#### NOTE

- Switching COLOUR system:  
Set the system to "AUTO" for normal TV reception. The AUTO mode automatically detects the receiving signal system and changes the reception system of the TV set. When the picture is not stable, switching to an appropriate system may improve the picture quality.
- In a weak reception area, or under bad reception conditions, you can change the frequency for fine tuning.
- When using FINE, the channel number changes from green to yellow.
- To return the channel to its original frequency setting, follow the manual channel tuning procedure. See **13**.

## Picture adjustment

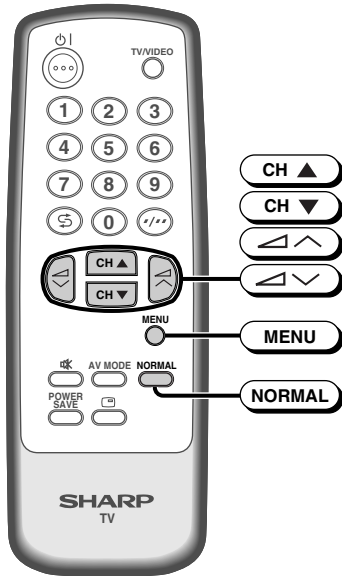

**1** Press **MENU** to call MENU screen.

**2** Press **CH ▲** / **CH ▼** to select "PICTURE".

**3** Press **↶** / **↷** to display PICTURE menu.

**4** Press **CH ▲** / **CH ▼** to select adjustment items.

**5** Adjust using **↶** / **↷**.  
 • Wait for approximately three seconds to return to PICTURE menu.

**6** Repeat steps 4 and 5 above to adjust other items.

**7** Press **MENU** until normal screen appears.

- When **NORMAL** is pressed while the PICTURE menu is displayed, the setting for the selected item is reset to the standard (factory setting) position.
- When **NORMAL** is pressed while the MENU screen is displayed and "PICTURE" is selected, all the settings for the PICTURE items are reset to the standard (factory setting) position.

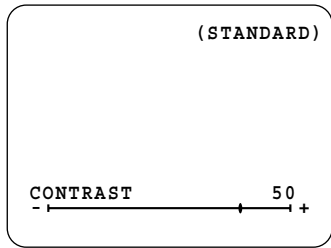
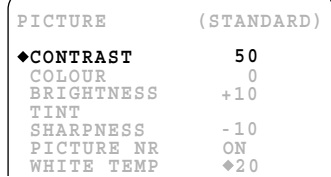
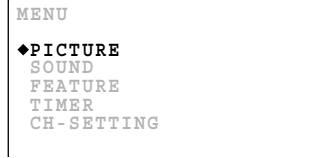

The following table lists the adjustment items shown in the PICTURE menu and how they change as you press **↶** / **↷**.

Selected item	Press <b>↷</b>	Press <b>↶</b>
CONTRAST	To decrease contrast -   ←   →   +	To increase contrast -   ←   →   +
COLOUR	For less colour intensity -   ←   →   +	For more colour intensity -   ←   →   +
BRIGHTNESS	For less brightness -   ←   →   +	For more brightness -   ←   →   +
TINT*-1	To move tint toward purple ◆   ←   →   ◇	To move tint toward green ◆   ←   →   ◇
SHARPNESS	For less sharpness -   ←   →   +	For more sharpness -   ←   →   +
PICTURE NR*-2	ON → OFF (See note below)	
WHITE TEMP	To more reddish background ◆   ←   →   ◇	To more bluish background ◆   ←   →   ◇

\*-1: TINT can only be selected and adjusted when receiving NTSC broadcasts. (AV only)

\*-2: Picture Noise Reduction

Noise might be generated on images when playing deteriorated video tapes or when receiving broadcasts with relatively weak signals. In these cases, set PICTURE NR to "ON" to reduce the noise. However, when receiving good images without noise, you can get better image quality by turning OFF this feature.

## Settings and adjustments

### Sound adjustment

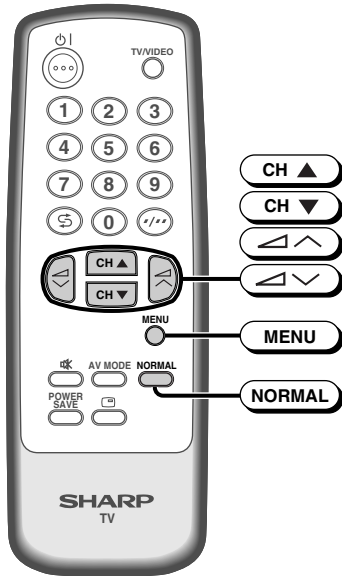

- 1** Press **MENU** to call MENU screen.
- 2** Press **CH ▲** / **CH ▼** to select "SOUND".
- 3** Press **▲** / **▼** to display SOUND menu.
- 4** Press **CH ▲** / **CH ▼** to select adjustment items.
- 5** Adjust using **▲** / **▼**.
  - Wait for approximately three seconds to return to SOUND menu.
- 6** Repeat steps 4 and 5 above to adjust other items.
- 7** Press **MENU** until normal screen appears.
  - When **NORMAL** is pressed while the SOUND menu is displayed, the setting for the selected item is reset to the standard (factory setting) position.
  - When **NORMAL** is pressed while the MENU screen is displayed and "SOUND" is selected, all the settings for the SOUND items are reset to the standard (factory setting) position.

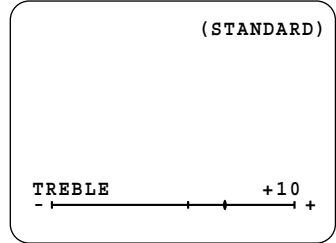
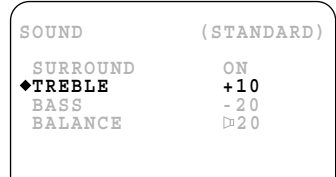
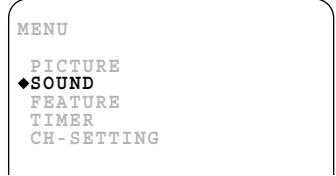

The following table lists the adjustment items shown in the SOUND menu and how they change as you press **▲** / **▼**.

Selected item	Press <b>▼</b>	Press <b>▲</b>
SURROUND	The surround effect is ON	The surround effect is OFF
TREBLE	To decrease treble	To increase treble
BASS	To decrease bass	To increase bass
BALANCE	To shift balance toward left	To shift balance toward right

## Blue screen

Automatically turns the screen blue if a broadcast signal is not received.

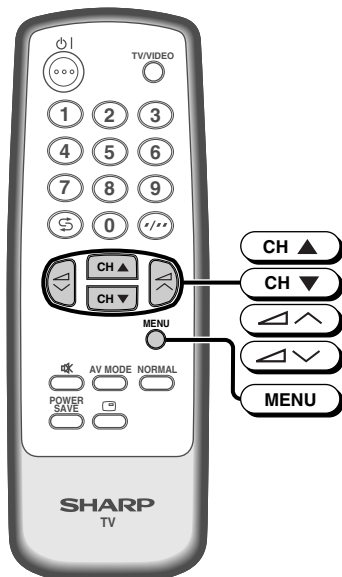

**1** Press **MENU** to call MENU screen.

**2** Press **CH ▲** / **CH ▼** to select "FEATURE".

**3** Press **▲** / **▼** to display FEATURE menu.

**4** Press **CH ▲** / **CH ▼** to select "BLUE BACK".

**5** Press **▲** / **▼** to select "ON" or "OFF".

**6** Press **MENU** until normal screen appears.

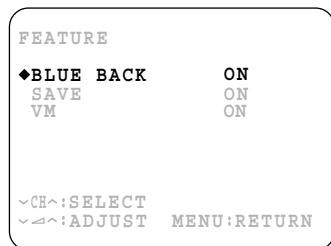
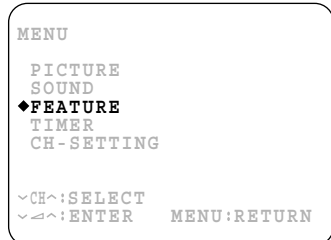

When BLUE BACK is set to "ON"

No signal



after five seconds

Blue screen



after 15 minutes

TV off



Standby mode

(Indicator)



Power indicator lights up red

### NOTE

- Poor reception due to weak signals and too much noise may activate BLUE BACK, despite the presence of a broadcast signal. To continue watching TV under these conditions, switch "BLUE BACK" to "OFF".
- When Off timer is set, the OFF TIMER setting has priority over BLUE BACK.

## Settings and adjustments

### Save

This function reduces the picture brightness to create a softer image while saving electricity.

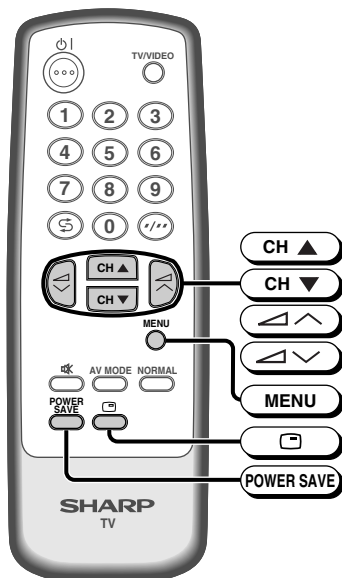

#### Using Menu

- 1 Press **MENU** to call MENU screen.
- 2 Press **CH ▲** / **CH ▼** to select "FEATURE".
- 3 Press **▲** / **▼** to display FEATURE menu.
- 4 Press **CH ▲** / **CH ▼** to select "SAVE".
- 5 Press **▲** / **▼** to select "ON" or "OFF".
  - When SAVE is set "ON", the POWER SAVE indicator on the TV set lights up in red.
  - When SAVE is set "OFF", the POWER SAVE indicator on the TV set is turn off.
- 6 Press **MENU** until normal screen appears.

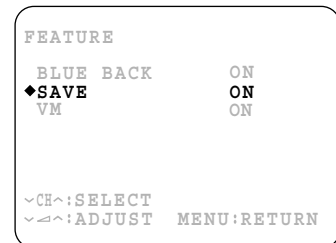
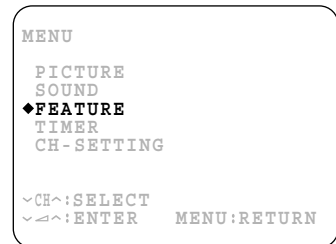

#### TV Set

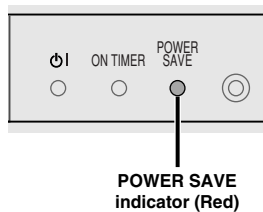

#### Using Remote Control

- 1 Press **POWER SAVE** to display the SAVE mode screen.
- 2 Each time you press **POWER SAVE**, the mode switches between "ON" and "OFF".
  - When SAVE is set "ON", the POWER SAVE indicator on the TV set lights up in red.
  - When SAVE is set "OFF", the POWER SAVE indicator on the TV set is turn off.
- 3 Press **POWER** to turn off the SAVE mode screen.

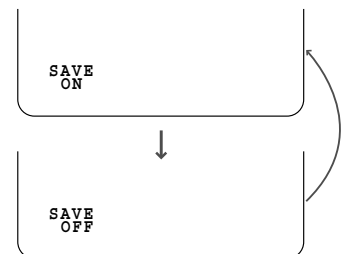



## VM (Velocity Modulation)

This function emphasizes the picture outline.

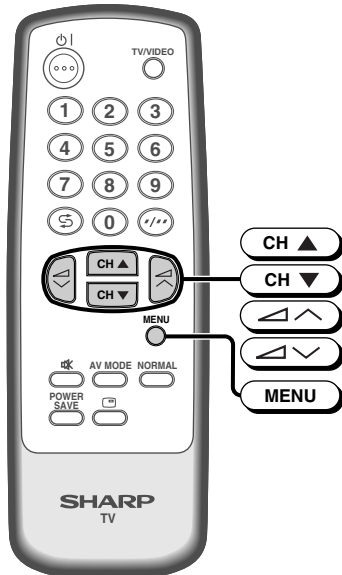

**1** Press **MENU** to call MENU screen.

**2** Press **CH ▲** / **CH ▼** to select "FEATURE".

**3** Press **▲** / **▼** to display FEATURE menu.

**4** Press **CH ▲** / **CH ▼** to select "VM".

**5** Press **▲** / **▼** to select "ON" or "OFF".

**6** Press **MENU** until normal screen appears.

```
MENU
PICTURE
SOUND
◆FEATURE
TIMER
CH-SETTING

~CH~:SELECT
~▲~:ENTER MENU:RETURN
```

```
FEATURE
BLUE BACK      ON
SAVE           ON
◆VM            ON

~CH~:SELECT
~▲~:ADJUST MENU:RETURN
```

**NOTE** • If a picture is received with noise, ensure that the VM is set to "OFF".

## Settings and adjustments

### Off timer

Automatically turns power off after a set length of time has passed.

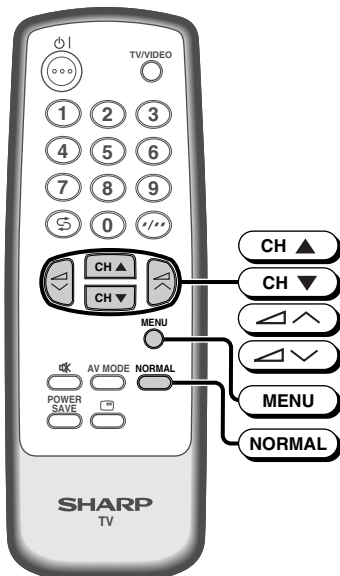

**1** Press **MENU** to call MENU screen.

```
MENU
PICTURE
SOUND
FEATURE
◆TIMER
CH-SETTING
```

**2** Press **CH ▲** / **CH ▼** to select "TIMER".

**3** Press **▲** / **▼** to display TIMER menu.

```
TIMER
◆OFF@  --:--
ON @  --:--
POSITION
VOLUME  --:--
E

~CH^:SELECT
~▲^:ADJUST MENU:RETURN
```

**4** Press **CH ▲** / **CH ▼** to select "OFF @".

**5** Press **▲** / **▼** to set time for TV to turn off.

- Maximum time that can be preset is 12 hours and 50 minutes.
- As soon as the time is entered, the timer starts to count down.

```
TIMER
◆OFF@  2:30
ON @  --:--
POSITION
VOLUME  --:--
E

~CH^:SELECT
~▲^:ADJUST MENU:RETURN
```

**6** Press **MENU** until normal screen appears.

- Five minutes before the preset length of time expires (in the example, after two hours and 25 minutes), the remaining time appears on the screen.
- A flashing display of the remaining time appears during the last few seconds.
- When the preset length of time has passed, the TV set enters the Standby mode.

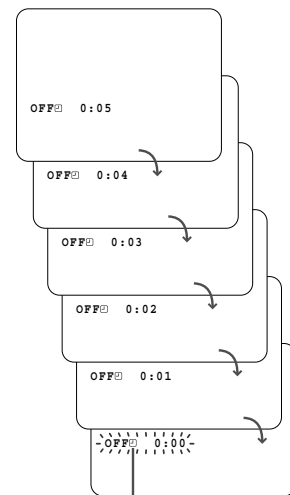

- NOTE**
- To cancel the timer setting, press **NORMAL** when "◆" is displayed on the left of "OFF @" so as to set the timer to "--:--".
  - The timer can be set in ten-minute intervals.
  - The Off timer is cancelled if the power is turned off or set to the Standby mode using **⏻** or **⏻** on the TV set, or if the power is otherwise interrupted.

## On timer

Automatically turns power on after a set length of time has passed.

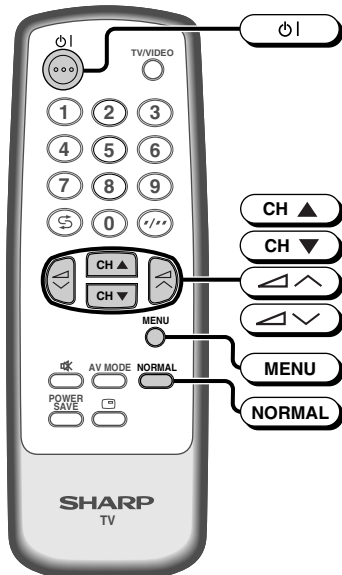

**1** Press **MENU** to call MENU screen.

```
MENU
PICTURE
SOUND
FEATURE
◆TIMER
CH-SETTING
```

**2** Press **CH ▲** / **CH ▼** to select "TIMER".

**3** Press **▲** / **▼** to display TIMER menu.

```
TIMER
OFF@  ---
◆ON @  ---
POSITION
VOLUME  ---
```

**4** Press **CH ▲** / **CH ▼** to select "ON @".

**5** Press **▲** / **▼** to set time for TV to turn on.

- Maximum time that can be preset is 12 hours and 50 minutes.
- As soon as the time is entered, the timer starts to count down.

```
TIMER
OFF@  ---
◆ON @  8:00
POSITION
VOLUME  --
```

**6** Press **CH ▲** / **CH ▼** to select "POSITION".

**7** Press **▲** / **▼** to set the channel.

```
TIMER
OFF@  ---
ON @  8:00
◆ POSITION  CH28
VOLUME  --
```

**8** Press **CH ▲** / **CH ▼** to select "VOLUME".

**9** Press **▲** / **▼** to set volume.

```
TIMER
OFF@  ---
ON @  8:00
POSITION  CH28
◆ VOLUME  20
```

**10** Press **Power** to put TV set into Standby mode.

- The On timer indicator lights up Red.
- When the preset length of time (in the above example, eight hours) has passed, the power turns on and a picture appears on the screen. The On timer speaker volume gradually increases from zero to the preset volume.

### TV Set

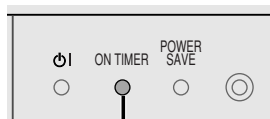

On timer indicator (Red)

- NOTE**
- To cancel the timer setting, press **NORMAL** when "◆" is displayed on the left of "ON @" so as to set the timer to " - : - : - ".
  - The timer can be set in ten-minute intervals.
  - The On timer is cancelled if the power is turned off using **Power**.
  - If the TV set is turned on by the On timer, then the TV set will be automatically turned off in two hours if no buttons are pressed on the TV set or remote control.

## Settings and adjustments

### Reminder on-screen timer

Lets you know when a preset length of time has passed by displaying a countdown timer on the screen. This is useful for timer cooking while you watch TV.

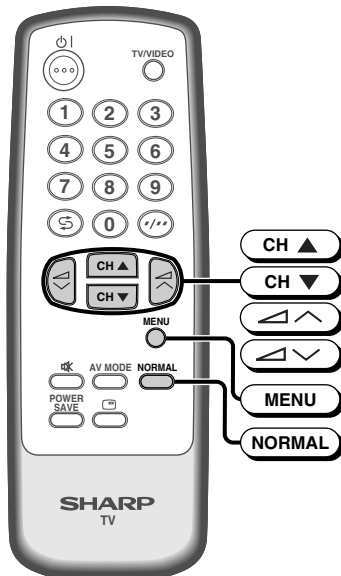

**1** Press **MENU** to call MENU screen.

```
MENU
PICTURE
SOUND
FEATURE
◆TIMER
CH-SETTING
```

**2** Press **CH ▲** / **CH ▼** to select "TIMER".

**3** Press **▲** / **▼** to display TIMER menu.

```
TIMER
OFF@      ---
ON @      ---
POSITION
VOLUME
◆H        ---
~CH^:SELECT
~<^:ADJUST MENU:RETURN
```

**4** Press **CH ▲** / **CH ▼** to select "H".

**5** Press **▲** / **▼** to set time.

- Maximum time that can be preset is 12 hours and 50 minutes.
- The right example shows that the Reminder will be activated after one hour 50 minutes.

```
TIMER
OFF@      ---
ON @      ---
POSITION
VOLUME
◆H        1:50
~CH^:SELECT
~<^:ADJUST MENU:RETURN
```

**6** Press **MENU** until normal screen appears.

- Five minutes before the preset length of time expires (in the example, after one hour and 45 minutes) and each minute thereafter, the remaining time appears on the screen for several seconds.
- When the preset length of time has passed, "H 0:00" flashes in red.

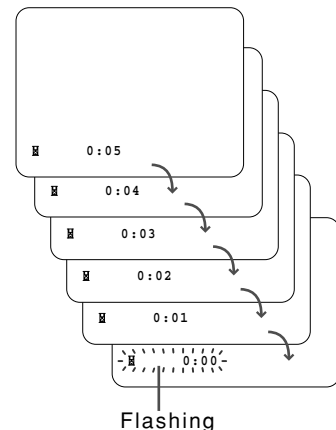

- NOTE**
- This function also works in the Standby mode. Power is automatically turned on five minutes before the preset length of time expires. The TV set automatically returns to the Standby mode approximately 30 seconds after the preset time.
  - The Reminder is cancelled if **OI** on the TV set is pressed or if the power is otherwise interrupted.
  - The timer can be set in ten-minute intervals.
  - To cancel the timer setting, press **NORMAL** when "◆" is displayed on the left of "H" so as to set the timer to "---".

# Connections

## Connecting to a DVD player

The DVD input terminals (COMPONENT-IN) on the rear of the TV can be used to input high-quality images from a DVD player.

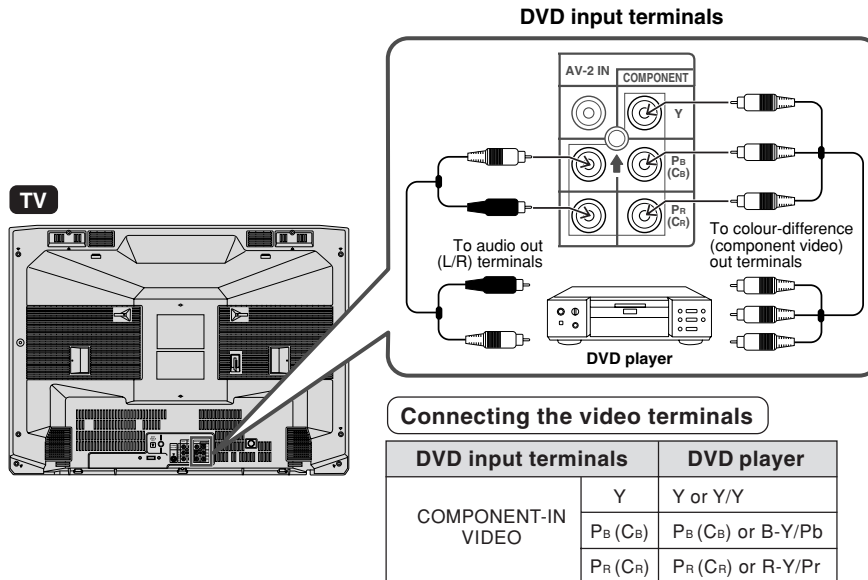

## Watching DVD Playback

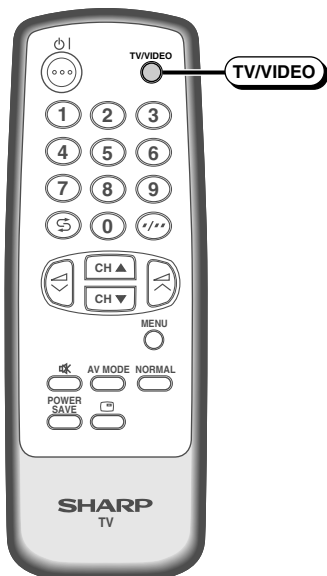

**1** Press **TV/VIDEO** to select "COMPONENT", DVD input screen.

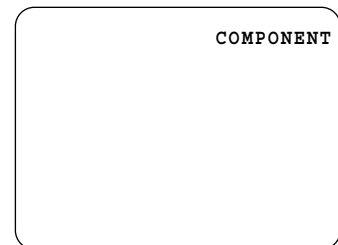

**2** Turn on the DVD player and begin playback.

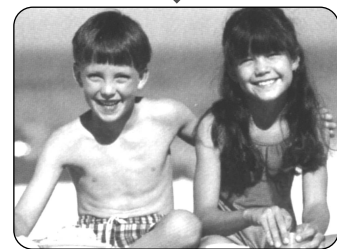

- NOTE**
- When connecting the TV to a DVD player via the Component-in terminals, the video and audio from the DVD player cannot be output through the Audio/Video out terminals on the TV.
  - Please refer to the operation manual of your DVD player for more information.
  - Be sure to fully insert the plugs of the connecting cables into the terminals on the TV set and video equipment. Failure to do so may result in noise.
  - Before connecting the cables, turn off the power of the TV set and video equipment.
  - Always remove the cables from the terminals by the plugs and not the cables themselves.

## Connecting to an antenna

To enjoy a clearer picture, use an outdoor antenna. The following is a brief explanation of the types of connections that are used for coaxial and feeder cables.

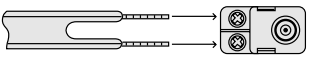
	If your outdoor antenna uses a 75-ohm coaxial cable with a standard DIN45325 plug (IEC 169-2), plug it into the antenna jack at the rear of the set.
	If your outdoor antenna uses a 300-ohm twin-lead flat feeder, connect a 300-ohm to 75-ohm impedance converter and plug it into the antenna jack at the rear of the set.

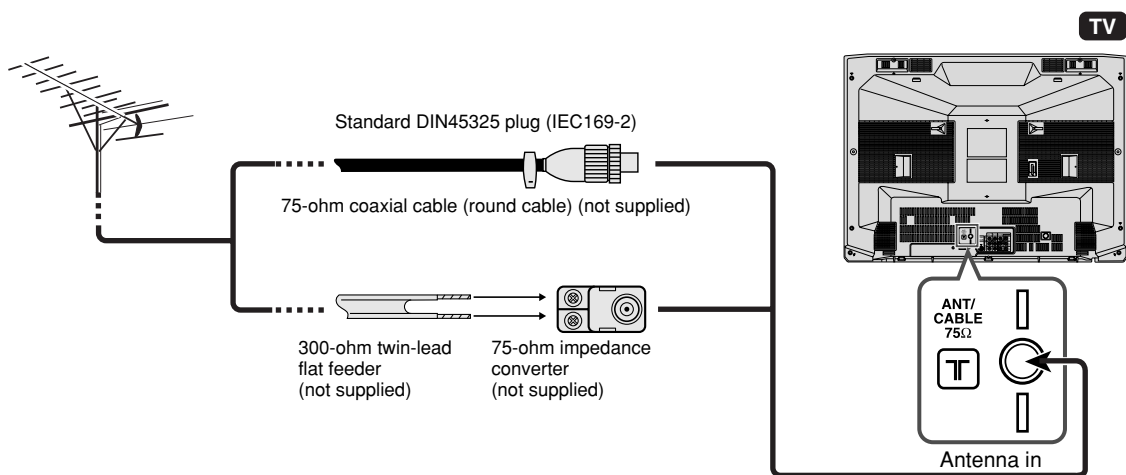

## Connecting to an antenna via a VCR

You can also connect the TV set to the tuner on a VCR using the connection shown below.

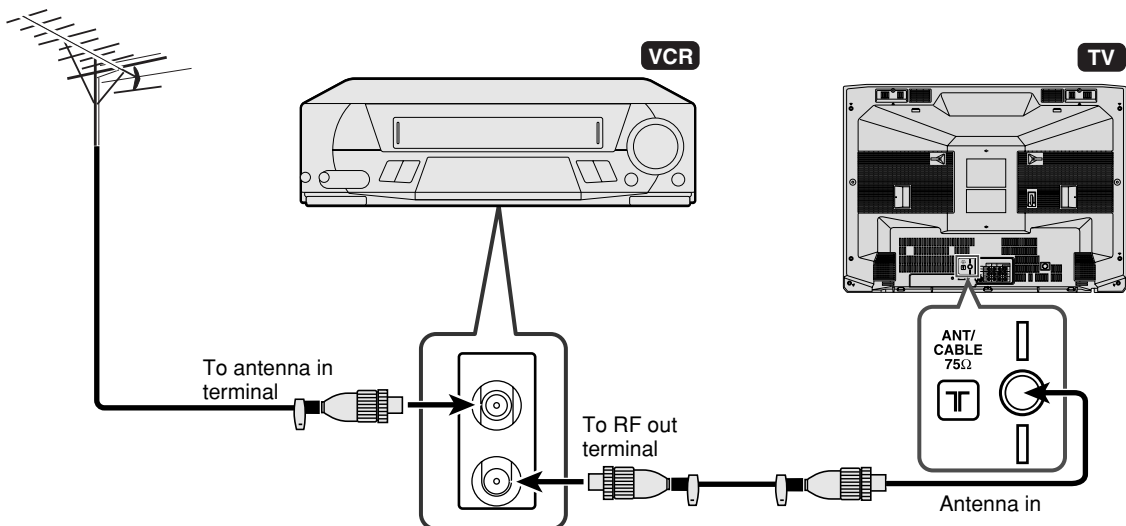

### NOTE

- When using the RF terminal connection, set the TV to channel zero to make initial adjustments for the VCR.
- Turn off the power on the TV set and the VCR being connected before making the above connections. Be sure the cord plugs are fully inserted in the connection terminals.
- See the operation manual of your VCR for connection details.



## Connections

### Connecting to video equipment

Enjoy playback from a video disc player, VCR or other video equipment by connecting them to this TV set using the Audio/Video in terminals.

Example use of front terminals

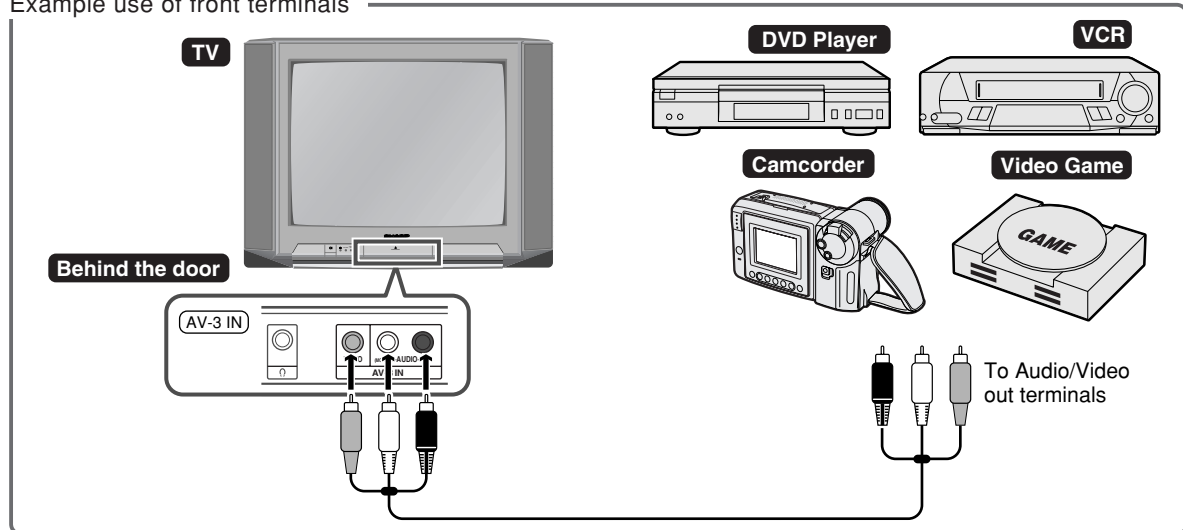

Example use of rear terminals

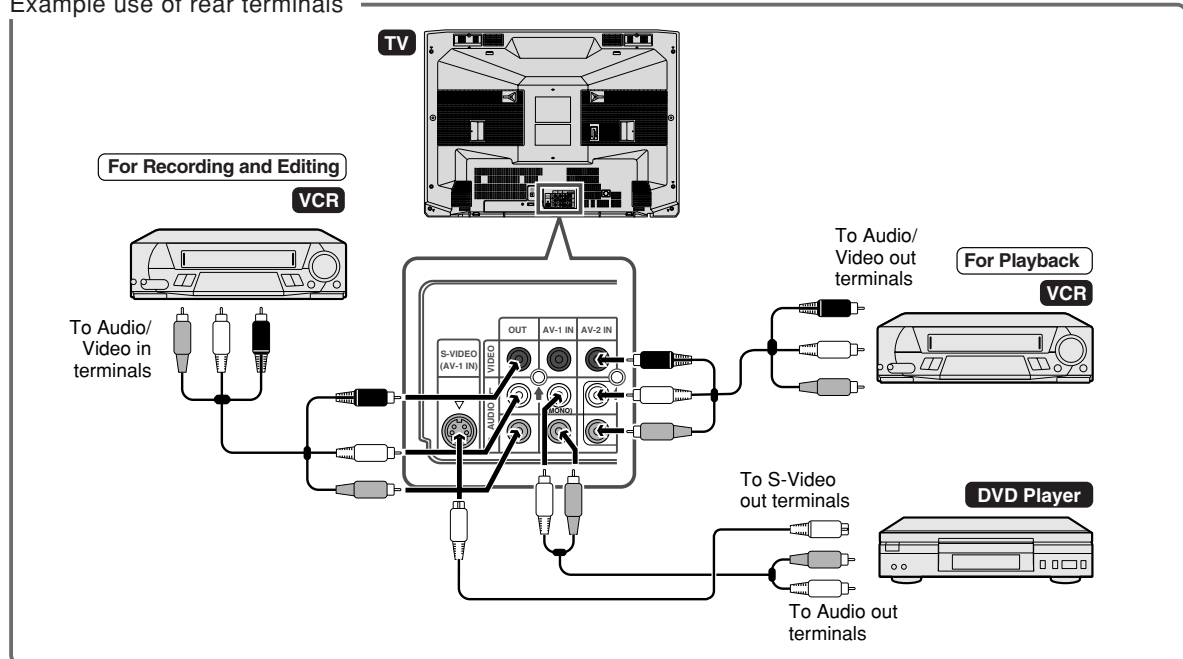

#### NOTE

- The S-Video Terminal has the priority over the AV terminal.
- The S-Video Terminal and Audio (L-R) terminals must be connected to playback DVD.
- Turn off the power on the TV set and the VCR being connected before making the above connections. Be sure the cord plugs are fully inserted in the connection terminals.
- For playback of monaural audio, connect the external source to the audio input left terminal on the front or rear of the TV set (MONO) to hear the same sound from both speakers.
- The audiovisual cords required to connect the TV set with video equipment may differ from those shown in the above diagram. See the operation manual of your video equipment for connection details.
- The above recording and editing connections are for intended solely for personal use and not for the illegal copying of audiovisual material protected by copyright laws.

# Troubleshooting

The following problems do not always indicate a hardware failure. Therefore, please use the troubleshooting guide below before calling for repair service.  
If, after following the guide none of the remedies work, unplug the TV set and call for service.

Quick Service Check List	Problems												
	Remote control does not work.	Bars on screen	Picture distorted.	Picture rolls vertically.	No colour	Poor reception on some channels	Picture weak.	Picture lines or streaks	Picture ghosting	Picture blurred.	Sound OK, picture poor.	Picture OK, sound poor.	No picture or sound
Possible Causes/Remedies													
Try a new channel to check for possible station trouble.			●	●	●	●	●	●	●	●	●	●	●
TV not plugged in. Outlet power OFF.	●												●
<b>POWER</b> switch of TV not ON.	●												●
Antenna not connected to terminal at the back of the TV set.					●	●	●		●		●		●
If outside antenna is used, check for broken wires.		●	●	●	●	●	●	●	●	●	●		●
Check for local interference.		●		●		●		●	●		●	●	
Turn OFF using the <b>POWER</b> switch, then turn ON again after a minute.	●												●
Adjust COLOUR control.					●		●				●		
Check batteries in the remote control.	●												
Try fine tuning to correct.			●		●		●			●	●		
Contrast setting in picture mode might be all the way to the minus side. Press the <b>NORMAL</b> button on the remote control to correct.											●		●
Increase the volume.												●	●

**NOTE** • This unit is equipped with a microprocessor. Its performance could be adversely affected by external electrical noise or interference. If this should happen, unplug the unit and plug it in again after a few minutes.



# Specifications

MODEL	CX68N5	
Receiving System		
TV Broadcasts/ VCR Playback	PAL-B/G	
VCR Playback (Using Video-in terminals)	PAL 60 Hz NTSC 3.58 MHz NTSC 4.43 MHz	
Laserdisc Player Playback (Using RF-in terminals)	PAL 5.5 MHz/60 Hz	
VCR Playback (Using S-Video terminal)	S-VIDEO NTSC 3.58 MHz S-VIDEO NTSC 4.43 MHz S-VIDEO PAL	
Special VCR and VDP Playback	Video-in 50/60 Hz S-VIDEO in 50/60 Hz	
Reception Channels		
PAL-B/G	VHF	AU0-AU12 ch, E2-E12 ch
	UHF	E21-E69 ch
CATV	S1-S20 ch, S21-S41 ch (Hyper)	
Receiving Frequency	44.25 MHz – 863.25 MHz	
Channel Tuning	100-channel Electronic Tuner with Full Auto Tuning System	
Picture Tube	68 cm Tinted	
Terminals	Audio/Video input × 3 (Front × 1, Rear × 2) Audio/Video output × 1 (Rear) Headphone jack (Front × 1) S-Video input × 1 (Rear) DVD input (COMPONENT-IN) × 1 (Rear)	
Sound Output	7.5 W (RMS) × 2	
Power Source	Rated AC 220–240V, 50 Hz	
Power Consumption	145 W	
Dimensions	800 (W) × 583 (H) × 497 (D) mm	
Weight	38.5 kg (Approx.)	

## NOTE

- Design and specifications are subject to change without notice.
- Receiving system: These receiving systems, encompassing all currently available technology, include those with planned broadcast, videotape and laserdisc hardware and software.
- Reception channels: Some examples of the main receivable channels are shown above.

# Notes

# Notes

# SHARP

## WARRANTY

*Consumer Electronic Products*

### Congratulations on Your Purchase!

This Sharp product is warranted against faults in materials and manufacture for a period of twelve (12)\* months from the date of original purchase.

If service is required during the warranty period, please contact your nearest Sharp Approved Service Centre. These repairs would be carried out at no charge to the owner, subject to the conditions specified herein.

The owner is responsible for any transportation and insurance costs if the product has to be returned for repair.

This warranty does not extend to accessories or defects or injuries caused by or resulting from causes not attributable to faulty parts or the manufacture of the product, including but not limited to, defect or injury caused by or resulting from misuse, abuse, neglect, accidental damage, improper voltage, liquid spillage, vermin infestation, software, or any alterations made to the product which are not authorised by Sharp.

Please retain your sales documentation, as this should be produced to validate a warranty claim.

This warranty is in addition to and in no way limits, varies or excludes any express and implied rights and remedies under any relevant legislation in the country of sale.

### IMPORTANT DO NOT RETURN THIS PAGE TO SHARP

For your reference, please enter the particulars of your purchase below and retain, with your purchase documentation.

Model No. \_\_\_\_\_

Serial No. \_\_\_\_\_

Date of Purchase \_\_\_\_\_

Retailer \_\_\_\_\_

FOR LOCATION ENQUIRIES WITHIN  
**AUSTRALIA**  
REGARDING YOUR  
LOCAL  
**SHARP APPROVED SERVICE CENTRE**  
LOOK ON THE WEB AT  
[www.sharp.net.au](http://www.sharp.net.au)  
OR CALL SHARP  
**1 300 135 022**

SHARP CORPORATION OF AUSTRALIA PTY. LIMITED  
A.B.N. 40 003 039 405  
1 Huntingwood Drive Blacktown NSW 2148

**IMPORTANT NOTICE: This warranty applies only to products sold in Australia**

# SHARP®

## SHARP CORPORATION

Printed in Malaysia  
TINS-A574WJZZ  
03P01-MSF



## Free Manuals Download Website

<http://myh66.com>

<http://usermanuals.us>

<http://www.somanuals.com>

<http://www.4manuals.cc>

<http://www.manual-lib.com>

<http://www.404manual.com>

<http://www.luxmanual.com>

<http://aubethermostatmanual.com>

Golf course search by state

<http://golfingnear.com>

Email search by domain

<http://emailbydomain.com>

Auto manuals search

<http://auto.somanuals.com>

TV manuals search

<http://tv.somanuals.com>