

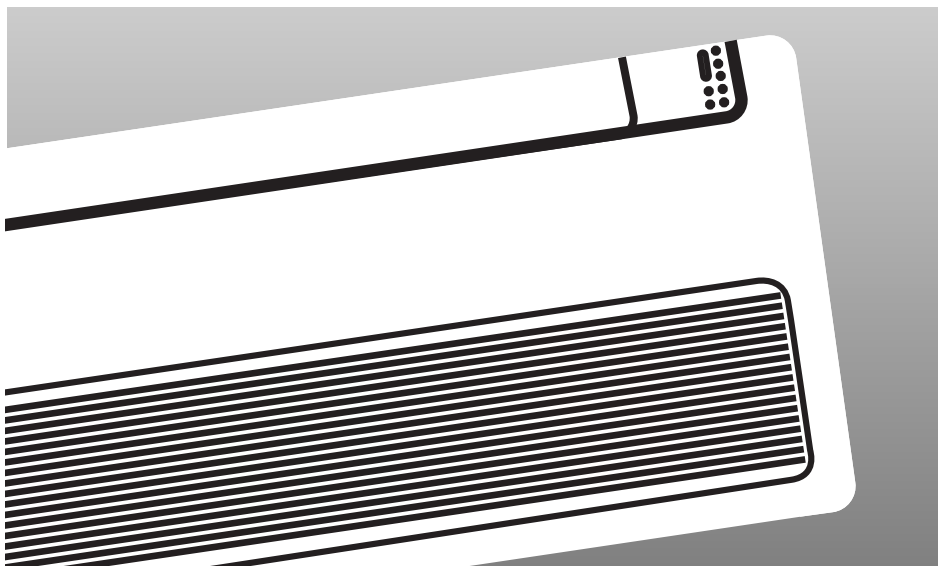

**OWNER'S INSTRUCTIONS
MANUAL DE INSTRUCCIONES
MANUEL D'UTILISATION
ISTRUZIONI PER L'USO
MANUAL DE INSTRUÇÕES
GEBRAUCHSANWEISUNG
ΟΔΗΓΙΕΣ ΧΕΙΡΙΣΜΟΥ
ИНСТРУКЦИЯ ПОЛЬЗОВАТЕЛЯ
FH052EAMT
FH070EAMT**

System Air Conditioner (Cool and Heat)
Aire acondicionado sistemático (Refrigeración y Calefacción)
Climatiseur numérique multifonctionnel (Refroidissement et Chauffage)
Sistema Aria Condizionata (Raffreddamento e Riscaldamento)
Sistema Ar Condicionado (Refrigeração e Aquecimento)
Klimaanlage System (Kühlen und Wärmen)
Σύστημα Κλιματισμού (Ψύξης και Θέρμανσης)
Системный Воздушный Кондиционер (Охлаждение и обогрев)



ENGLISH

ESPAÑOL

FRANÇAIS

ITALIANO

PORTUGUÊS

DEUTSCH

ΕΛΛΗΝΙΚΑ

RUSSIAN

Safety Precautions



WARNING

- ◆ If the power supply cord of this air conditioner is damaged, it must be replaced by the manufacturer or its authorized service personnel only in order to avoid a safety hazard.



DANGER

- ◆ Do not attempt to install this air conditioner by yourself.
- ◆ This unit contains no user-serviceable parts. Always consult authorized service personnel for repairs.
- ◆ When moving, consult authorized service personnel for disconnection and installation of the unit.
- ◆ Do not become over-exposed to cold air by staying in the direct path of the airflow of the air conditioner for extended periods of time.
- ◆ Do not insert fingers or objects into the outlet port or intake grilles.
- ◆ Do not start and stop air conditioner operation by disconnecting the power supply cord and so on.
- ◆ Take care not to damage the power supply cord.
- ◆ In the event of a malfunction (burning smell, etc.), immediately stop operation, turn off the electrical breaker, and consult authorized service personnel.



CAUTION

- ◆ Provide occasional ventilation during use.
- ◆ Do not direct air flow at fireplaces or heating apparatus.
- ◆ Do not climb on, or place objects on, the air conditioner.
- ◆ Do not hang objects from the indoor unit.
- ◆ Do not set flower vases or water containers on top of air conditioners.
- ◆ Do not expose the air conditioner directly to water.
- ◆ Do not operate the air conditioner with wet hands.
- ◆ Do not pull power supply cord.
- ◆ Turn off power source when not using the unit for extended periods.
- ◆ Check the condition of the installation stand for damage.
- ◆ Do not place animals or plants in the direct path of the air flow.
- ◆ Do not drink the water drained from the air conditioner.
- ◆ Do not use in applications involving the storage of foods, plants or animals, precision equipment, or art works.
- ◆ Do not apply any heavy pressure to radiator fins.
- ◆ Operate only with air filters installed.
- ◆ Do not block or cover the intake grille and outlet port.
- ◆ Ensure that any electronic equipment is at least one metre away from either the indoor or outdoor units.
- ◆ Avoid installing the air conditioner near a fireplace or other heating apparatus.
- ◆ When installing the indoor and outdoor unit, take precautions to prevent access to infants.
- ◆ Do not use inflammable gases near the air conditioner.
- ◆ Max input power & current is measured according to IEO standard and input power & current is measured according to ISO standard.
- ◆ Before throwing out the device, it is necessary to pull back the battery cells and get rid of them safely.
- ◆ The appliance is not intended for use by young children or infirm persons without supervision; young children should be supervised to ensure that they do not play with the appliance.

Contents

◆ *PREPARING YOUR AIR CONDITIONER*

- Safety Precautions 2
- View of the Unit 4
- Wireless Remote Controller-Buttons and Display 6
- Wired Remote Controller-Buttons and Display 7
- Centralized Controller 8
- Function Controller 9

◆ *RECOMMENDATIONS FOR USE*

- Adjusting the Air Flow Direction 10
- Operating Recommendations 11
- Temperature and Humidity Ranges 12
- Cleaning Your Air Conditioner 13
- Solving Common Problems 14

◆ *TECHNICAL SPECIFICATIONS*

View of the Unit

The figures are shown in this instruction may differ from yours depending on the model.

Indoor Unit

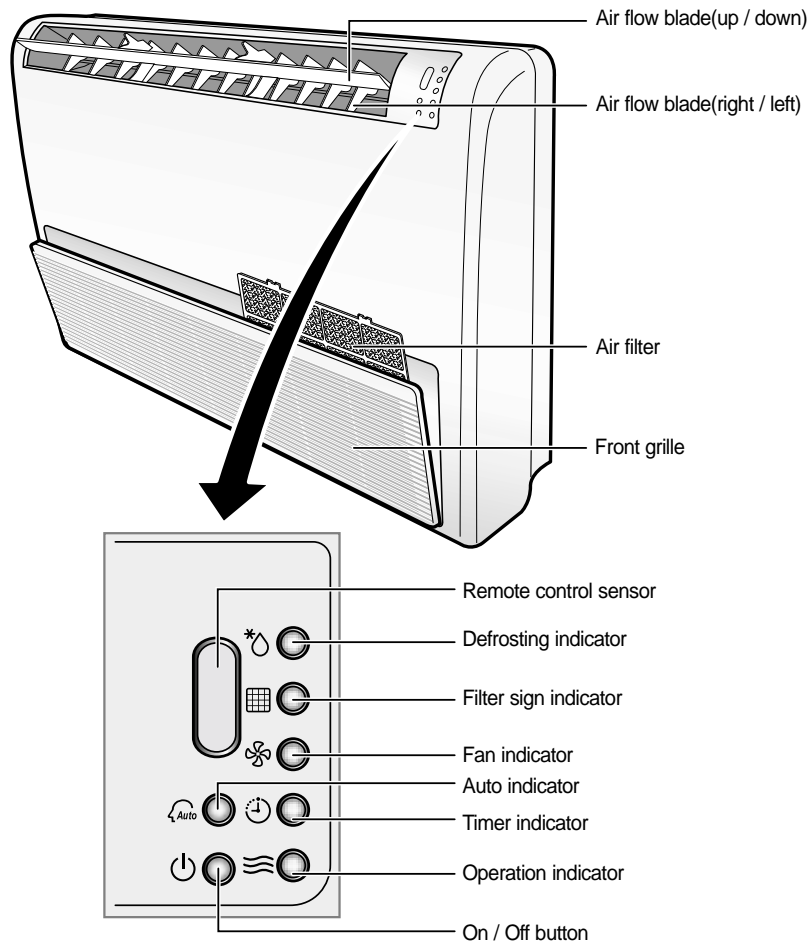

Outdoor Unit

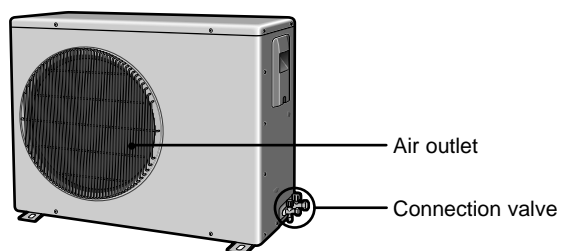

Note If the heat exchanger in the outdoor unit gets dusty, cooling efficiency may fall. So clean the heat exchanger with water when it becomes dirty. However, be careful when you wash the surface of the heat exchanger because it is very sharp.

Wireless Remote Controller-Buttons and Display

The wireless remote controller is an optional accessory.
To use the wireless remote controller, refer to an appropriate manual.

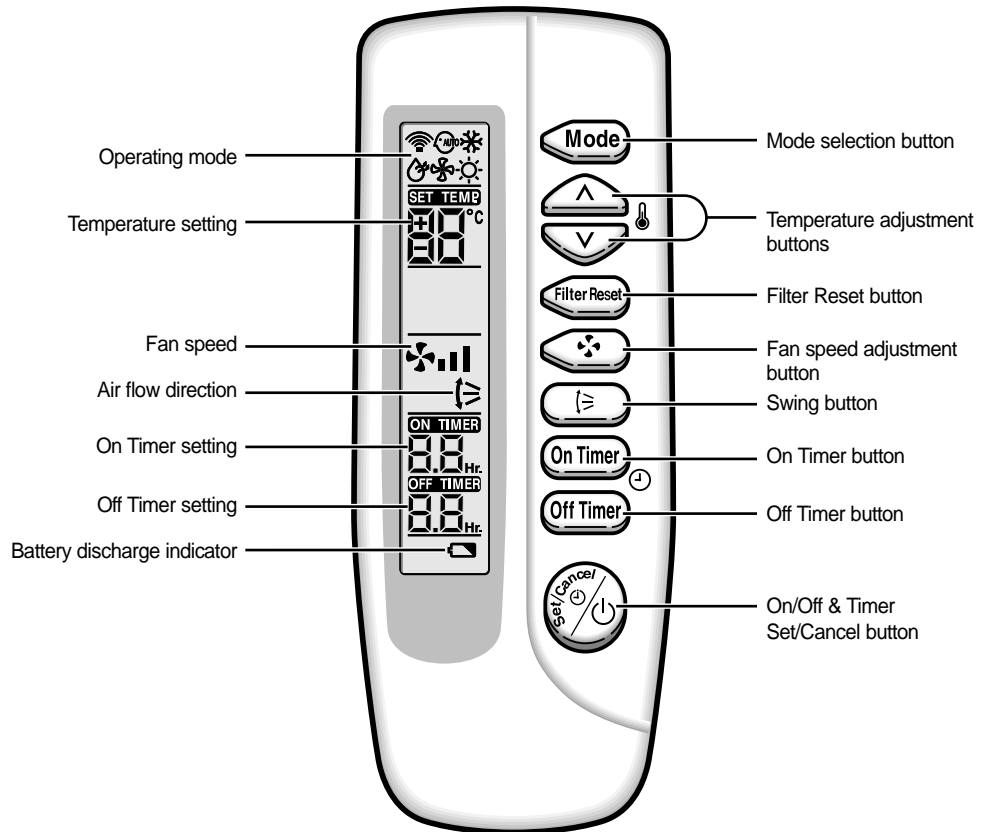

Note ◆ After cleaning the air filter, press the filter reset button.

Wired Remote Controller-Buttons and Display

The wired remote controller is an optional accessory and it is installed on the wall.
To use the wired remote controller, refer to an appropriate manual.

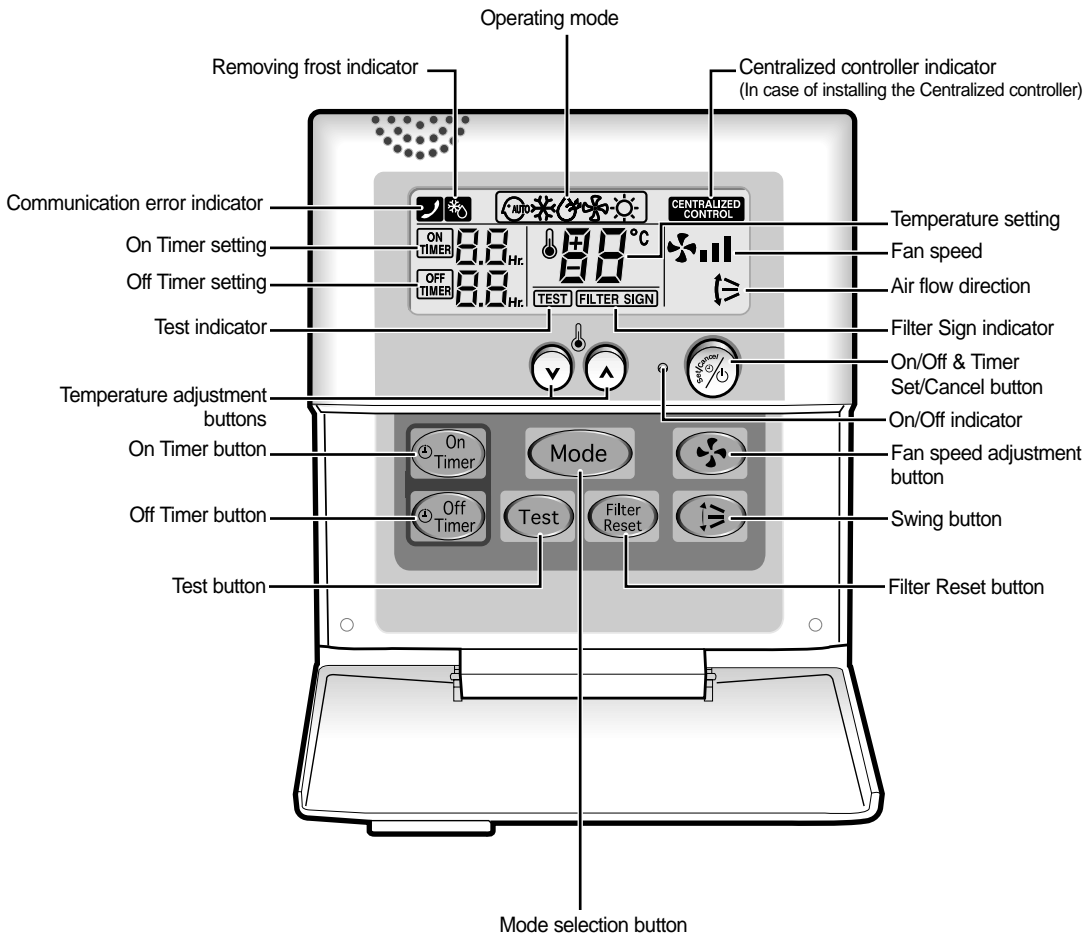

- Note**
- ◆ Test button is for your installation specialist. You must NOT press it.
 - ◆ After cleaning the air filter, press the filter reset button. Then the wired remote controller will display the FILTER SIGN indicator when the time to clean the air filter; refer to page 13.

Centralized Controller

The centralized controller is an optional accessory and it is installed on the wall. To use the centralized controller, refer to an appropriate manual.

Front View

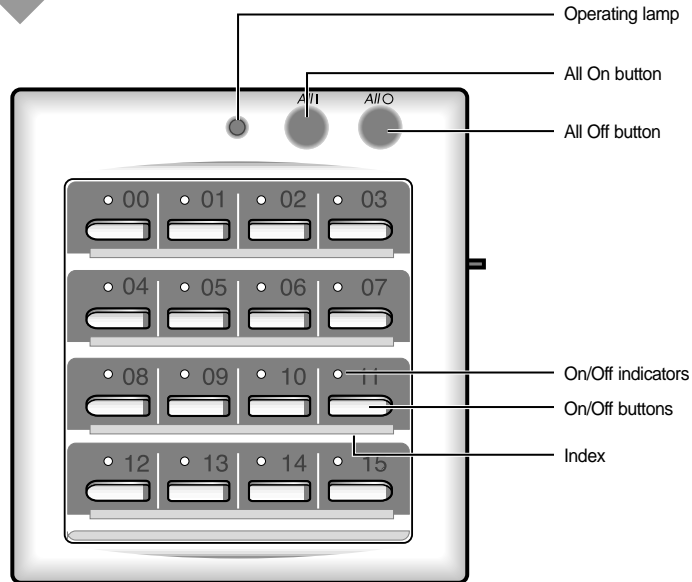

Note ♦ The operating lamp comes on even when only one air conditioner connected to the centralized controller is operating.

Side View

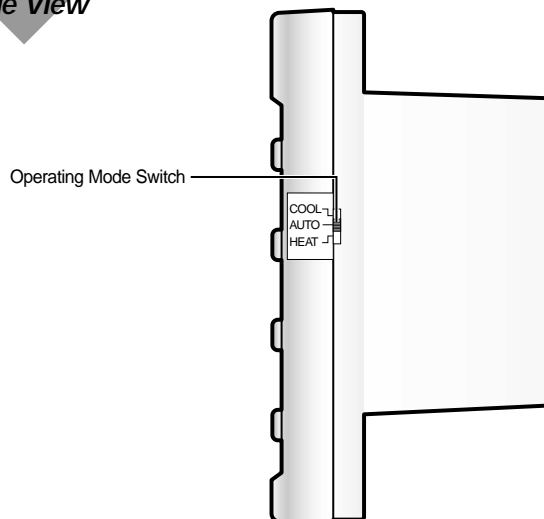

Note ♦ Choose the appropriate operating mode with the Operating Mode Switch that enables the user to choose between the Cool/Auto/Heat mode.

Function Controller

The function controller is an additional controller which is used with the centralized controller.
To use the function controller, refer to an appropriate manual.

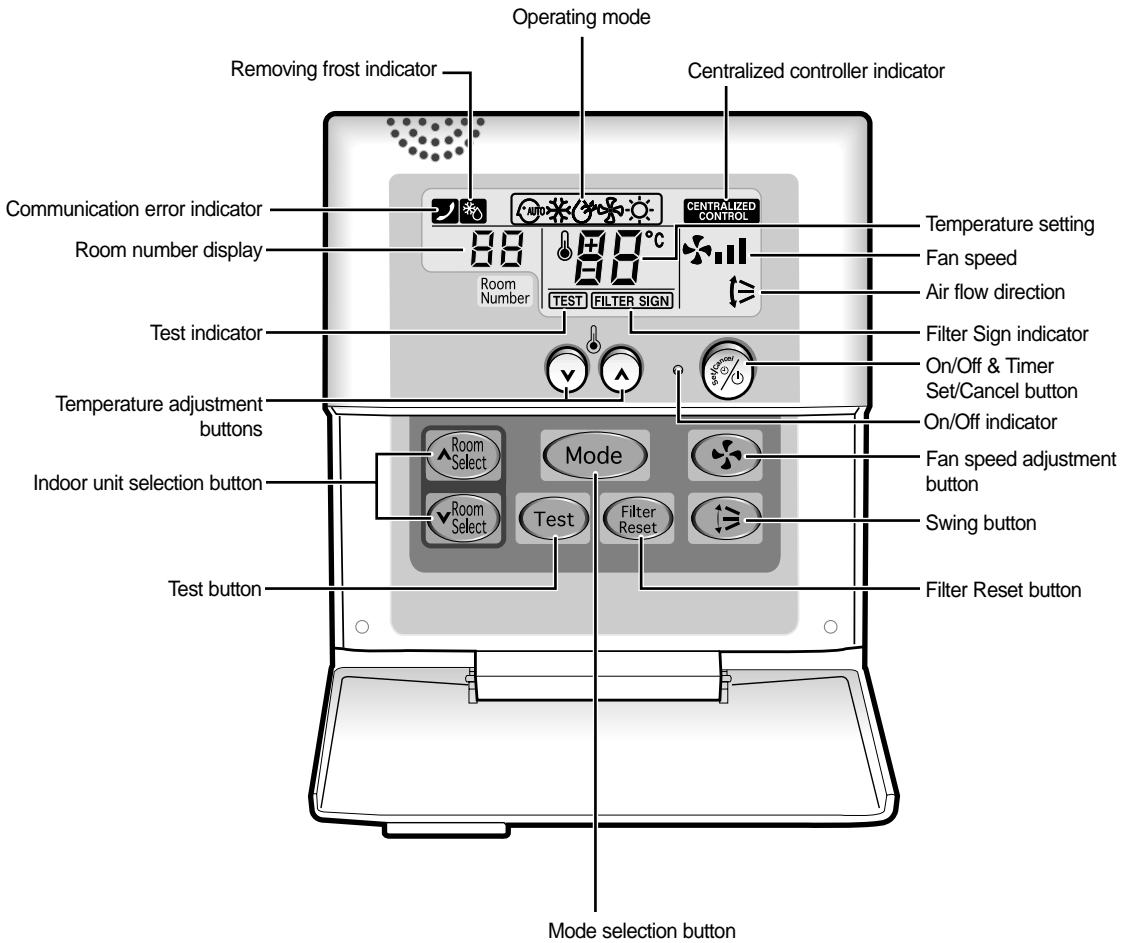

- Note**
- ◆ Test button is for your installation specialist. You must NOT press it.
 - ◆ After cleaning the air filter, press the filter reset button. Then the wired remote controller will display the FILTER SIGN indicator when the time to clean the air filter.

Adjusting the Air Flow Direction

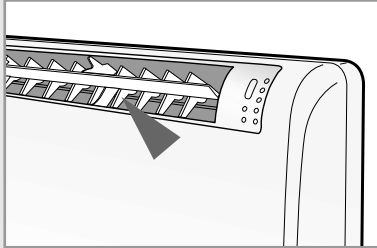

There are two sets of inner air flow blades. Just as the outer air flow blade can be adjusted vertically, the inner blades can be adjusted horizontally.

Adjust each set of inner blades to the required position, by pushing or pulling them sideways.

Operating Recommendations

Here are a few recommendations that you should follow when operating your air conditioner.

Topic	Recommendation
Heating performances	The heat pump function of the air conditioner absorbs heat from outside air and brings it indoors. As the temperature of the outside air drops, the heating performance of air conditioner will decrease. If you find that the room is not warm enough, using an additional heating appliance is recommended.
Frost	When outside temperature is low but humidity is high, frost may form on the outdoor unit at HEAT mode. If this happens: <ul style="list-style-type: none">◆ The heating operation stops.◆ The defrost mode will be triggered automatically for about ten minutes. No intervention is required ; after about ten minutes, the air conditioner operates again normally.
High indoor and outdoor temperatures	If both indoor and outdoor temperatures are high and the air conditioner is running at HEAT mode, the outdoor unit's fan and compressor may stop at times. This is normal ; simply wait until the air conditioner switches on again.
Power failure	If a power failure occurs while the air conditioner is operating, the unit will be switched off. When the power returns, the air conditioner starts up again automatically.

Temperature and Humidity Ranges

The following table indicates the temperature and humidity ranges, within which the air conditioner can be used.

If the air conditioner is used at...	Then...
High temperature	The automatic protection feature may be triggered and the air conditioner stopped.
Low temperature	A water leakage or some other malfunction may happen if the heat exchanger freezes.
High humidity levels	Water may condense on and drip from the surface of the indoor unit if it is used for a long periods.

Mode	Outdoor Temperature	Indoor Temperature	Indoor Humidity
Heating	-5°C to 24°C approx.	27°C or less	-
Cooling	-5°C to 43°C approx.	21°C to 32°C approx.	80% or less
Drying	-5°C to 43°C approx.	21°C to 32°C approx.	-

※ *If the heating operation is used at below -5°C (outdoor temperature) then, it does not heat at its full capacity.*

If the cooling operation is used at over 32°C (indoor temperature) then, it does not cool at its full capacity.

Cleaning Your Air Conditioner

To get the best possible use out of your air conditioner, you must to clean it to remove the dust that accumulates on the air filters.

IMPORTANT Before cleaning your air conditioner, ensure that you have switched off the breaker used for the unit.

- 1 Open the front grille by pushing on both sides and center.
- 2 Pull the air filters in upward direction to remove them. Remove all dust from the air filters by vacuum cleaner, brush or by washing them with a detergent and warm water below 40°C. After washing, allow them to dry thoroughly in an area protected from sunlight.
- 3 Insert the air filters to the front grille.
- 4 Close the front grille by pushing both sides and center.

- Note**
- ◆ If you have not used the air conditioner for a long period of time, set the fan going for three or four hours to dry the inside of the air conditioner thoroughly.
 - ◆ If you don't clean the air filter at least every two weeks, its performance may be reduced and noise may increase.
 - ◆ After cleaning the air conditioner, press the Filter Reset button.

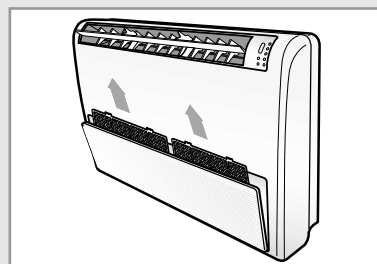

Wired Remote Controller

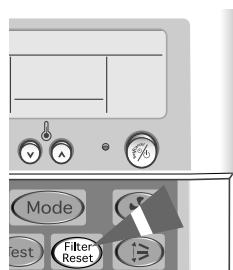

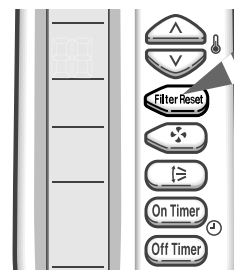

Wireless Remote Controller



Solving Common Problems

Before contacting the after-sales service, perform the following simple checks. They may save your time and expense of an unnecessary call.

<u>Problem</u>	<u>Explanation/Solution</u>
The air conditioner does not operate at all	<ul style="list-style-type: none"> ◆ Check that the breaker used for the air conditioner is switched on.
Wired Remote Controller	
The air conditioner does not operate with the remote controller	<ul style="list-style-type: none"> ◆  is displayed on the wired remote controller. In this case, turn the air conditioner off and contact your dealer.
Wired Remote Controller	
When turning on/off the air conditioner, it is not turned on/off immediately.	<ul style="list-style-type: none"> ◆ In case of using the wired remote controller for a group, the air conditioners connected to the remote controller are turned on/off in order. Thus, it takes some time (up to 32 seconds).
Wireless Remote Controller	
The air conditioner does not operate with the remote controller	<ul style="list-style-type: none"> ◆ Check that there are no obstacles between you and the remote control sensor. ◆ Check the wireless remote controller batteries. ◆ Check that you are close enough to the remote control sensor. (seven metres/yards or less).
Wireless Remote Controller	
No beep is heard when you press  (ON/OFF) on the remote controller	<ul style="list-style-type: none"> ◆ Check that you are pointing the remote controller at the remote control sensor on the indoor unit. ◆ Replace the remote controller batteries if necessary. ◆ If there is a strong light around the air conditioner, a three-wavelength light, a neon sign, etc., for example, the air conditioner may not be operated with a remote controller. If this happens, use the remote controller close by the remote control sensor.
The air conditioner does not cool or heat	<ul style="list-style-type: none"> ◆ Check that the correct operating mode has been selected. ◆ The room temperature may be too low or too high. ◆ Dust may be blocking the air filter guard; refer to page 13 for cleaning instructions. ◆ Check that there is no obstacle in front of the outdoor unit.
When heating, the required room temperature is never reached and the air conditioner frequently stops	<ul style="list-style-type: none"> ◆ Check that the required temperature has been set correctly. ◆ Increase the fan speed.

Technical Specifications

Model	Power Supply
FH052EAMT FH070EAMT	1Ø, 220-240V~, 50Hz

**THIS AIR CONDITIONER IS MANUFACTURED BY:
ESTE AIRE ACONDICIONADO HA SIDO FABRICADO POR:
CE CLIMATISEUR EST FABRIQUE PAR:
QUESTO CONDIZIONATORE D'ARIA È PRODOTTO DA:
ESTE APARELHO DE AR CONDICIONADO É FABRICADO POR:
DIESE KLIMAANLAGE IST FABRIZIERT VON:
ΑΥΤΗ Η ΣΥΣΚΕΥΗ ΚΑΤΑΣΚΕΥΑΣΤΗΚΕ ΑΠΟ:
ЭТОТ КОНДИЦИОНЕР ИЗГОТОВЛЕН ФИРМОЙ:**



ELECTRONICS

Free Manuals Download Website

<http://myh66.com>

<http://usermanuals.us>

<http://www.somanuals.com>

<http://www.4manuals.cc>

<http://www.manual-lib.com>

<http://www.404manual.com>

<http://www.luxmanual.com>

<http://aubethermostatmanual.com>

Golf course search by state

<http://golfingnear.com>

Email search by domain

<http://emailbydomain.com>

Auto manuals search

<http://auto.somanuals.com>

TV manuals search

<http://tv.somanuals.com>