

RYOBI®

155r

12 Volt Battery Trimmer

OPERATOR'S MANUAL

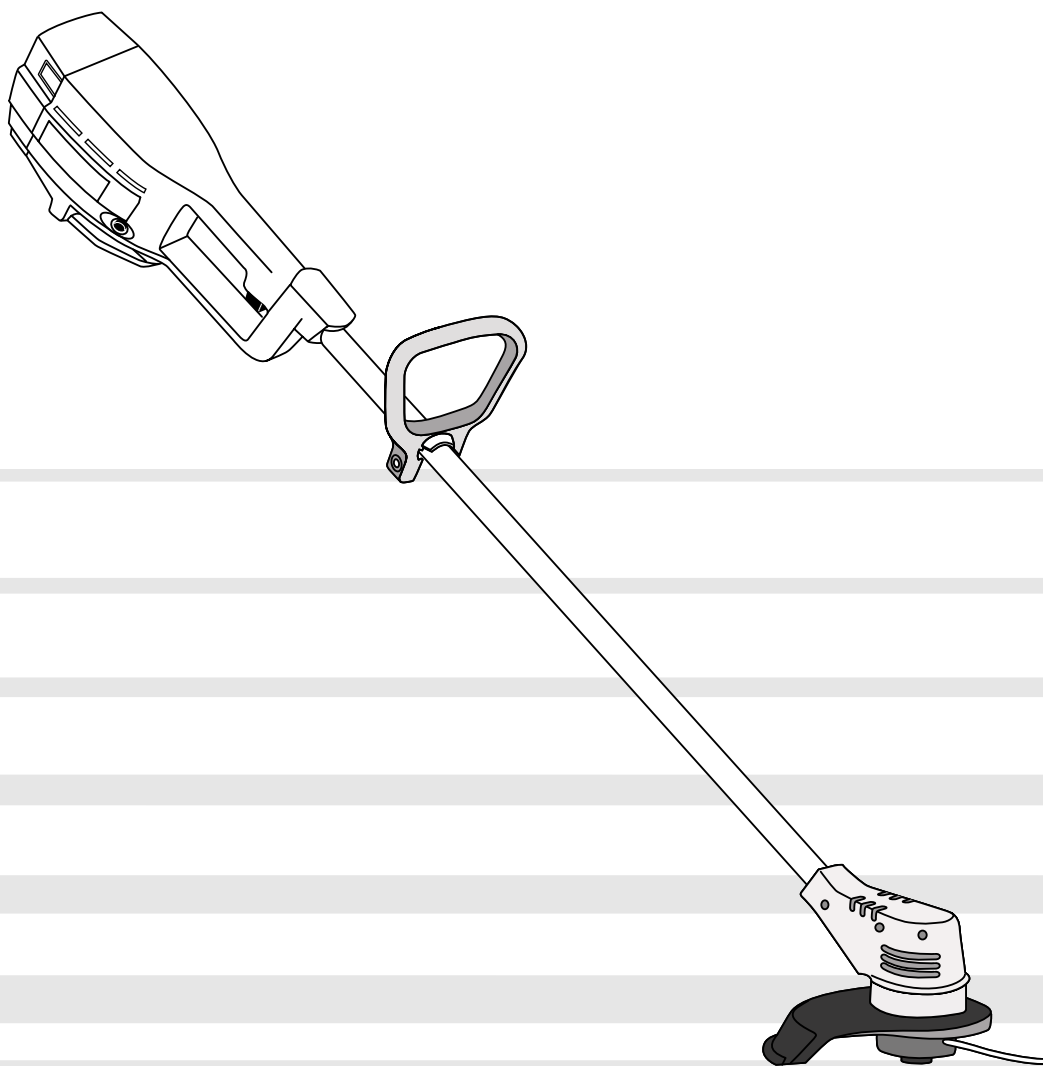

FOR QUESTIONS, CALL 1-800-345-8746 in U.S. or
1-800-265-6778 in CANADA
www.ryobi.com

IMPORTANT MANUAL

DO NOT THROW AWAY

INTRODUCTION

THANK YOU

Thank you for buying this quality product. This modern outdoor power tool will provide many hours of useful service. You will find it to be a great labor-saving device. This operator's manual provides you with easy-to-understand operating instructions. Read the whole manual and follow all the instructions to keep your new outdoor power tool in top operating condition.

PRODUCT REFERENCES, ILLUSTRATIONS AND SPECIFICATIONS

All information, illustrations and specifications in this manual are based on the latest product information available at the time of printing. We reserve the right to make changes at any time without notice.

Copyright© 1999 Ryobi Outdoor Products, Inc.
All Rights Reserved.

SERVICE INFORMATION

Service on this unit both within and after the warranty period should be performed only by an authorized and approved service dealer.

Dial:

- **1-800-345-8746** or **www.ryobi.com** on the world wide web for authorized service dealers in the United States.

Or

- **1-800-265-6778** in Canada to obtain the listing of the authorized service dealer nearest you.

DO NOT RETURN THE UNIT TO THE RETAILER.

NOTE: PROOF OF PURCHASE WILL BE REQUIRED FOR WARRANTY SERVICE.

Make sure this manual is carefully read and understood before starting or operating this equipment.

THIS PRODUCT IS COVERED BY ONE OR MORE US PATENTS, OTHER PATENTS PENDING.

TABLE OF CONTENTS

| | | |
|------|--|-------|
| I. | Rules for Safe Operation | 3-6 |
| | A. Important Safety Information | 3-4 |
| | B. Safety and International Symbols | 5 |
| | C. Know Your Unit | 6 |
| II. | Assembly Instructions | 7 |
| | A. Mounting the Charging Station | 7 |
| | B. Adjusting the D-Handle | 7 |
| III. | Operating Instructions | 8-10 |
| | A. Charging the Unit | 8 |
| | B. To Start Unit | 9 |
| | C. To Stop Unit | 9 |
| | D. Overload Protection Switch | 9 |
| | E. Holding the Unit | 9 |
| | F. Operating the Trimmer | 10 |
| | G. Adjusting Trimming Line Length | 10 |
| | H. Decorative Trimming | 10 |
| | I. Tips for Best Trimming Results | 10 |
| IV. | Maintenance and Repair Instructions | 11-14 |
| | A. General Recommendations | 11 |
| | B. Line Installation | 11 |
| | C. Installing a Prewound Reel | 12 |
| | D. Battery Pack Replacement | 13 |
| | E. Replacing the Charger | 14 |
| | F. Cleaning the Unit | 14 |
| | G. Storing the Unit | 14 |
| | H. Accessories and Replacement parts | 14 |
| V. | Troubleshooting Chart | 15 |
| VI. | Specifications | 15 |
| VII. | Warranty | 16 |

CONTENTS OF CARTON

This unit should consist of the following:

- Model 155r, Assembled with Battery, D-Handle, and Cutting Attachment Shield
- Charging Station with Charger
- Operator's Manual
- Product Registration Card

RULES FOR SAFE OPERATION

The purpose of safety symbols is to attract your attention to possible dangers. The safety symbols, and their explanations, deserve your careful attention and understanding. The safety warnings do not by themselves eliminate any danger. The instructions or warnings they give are not substitutes for proper accident prevention measures.

| SYMBOL | MEANING |
|---|---|
|  | SAFETY ALERT SYMBOL: Indicates danger, warning, or caution. Attention is required in order to avoid serious personal injury. May be used in conjunction with other symbols or pictographs. |
| NOTE: Advises you of information or instructions vital to the operation or maintenance of the equipment. | |



DANGER: Failure to obey a safety warning will result in serious injury to yourself or to others. Always follow the safety precautions to reduce the risk of fire, electric shock, and personal injury.



WARNING: Failure to obey a safety warning can result in injury to yourself and others. Always follow the safety precautions to reduce the risk of fire, electric shock, and personal injury.



CAUTION: Failure to obey a safety warning may result in property damage or personal injury to yourself or to others. Always follow the safety precautions to reduce the risk of fire, electric shock, and personal injury.

• IMPORTANT SAFETY INSTRUCTIONS •



WARNING: When using battery trimmers, basic safety precautions should always be followed to reduce the risk of fire, electric shock, and personal injury. Carefully read and understand the entire Operator's Manual before using your trimmer. Pay close attention to the Operating Instructions and Safety Warnings.

READ ALL INSTRUCTIONS

BEFORE OPERATING

- Read the instructions carefully. Be familiar with the controls and proper use of the unit.
- Do not operate this unit when tired, ill, or under the influence of alcohol, drugs, or medication.
- Inspect the unit before use. Replace damaged parts. Check for battery leaks. Make sure all fasteners are in place and secure. Replace cutting attachment that are cracked, chipped, or damaged. Make sure the cutting attachment is properly installed and securely fastened. Be sure the cutting attachment shield is properly attached, and positioned as recommended. Failure to do so can result in personal injury to the operator and bystanders, as well as damage to the unit.
- Avoid dangerous environments. Never operate your unit in damp or wet conditions. Moisture is a shock hazard.
- Do not use the unit in the rain.
- Do not handle the unit with wet hands.
- Use only 0.080 in (2.03 mm) diameter genuine Ryobi replacement line. Never use metal-reinforced line, wire, or rope, etc. These can break off and become a dangerous projectile.
- Children and teens under the age of 15 must not use the unit, except for teens guided by an adult.
- Be aware of the risk of injury to the head, hands and feet.

- Clear the area to be cut before each use. Remove all objects such as rocks, broken glass, nails, wire, or string which can be thrown or become entangled in the cutting attachment. Clear the area of children, bystanders, and pets. At a minimum, keep all children, bystanders and pets outside a 50 feet (15 m) radius; there still may be a risk to bystanders from thrown objects. Bystanders should be encouraged to wear eye protection. If you are approached, stop the motor and cutting attachment immediately.

SAFETY WARNINGS FOR BATTERY TRIMMERS

- Battery tools do not have to be plugged into an electrical outlet; therefore, they are always in operating condition. Be aware of possible hazards even when tool is not operating. Take care when performing maintenance or service.
- Remove or disconnect the battery before servicing, cleaning, or removing material from the unit.
- Use only the charging station provided with your unit or optional Battery & Charger Accessory Kit, model 300028. Do Not substitute any other charging means. Use of another charging means could cause batteries to explode, resulting in possible serious personal injury.
- Do not charge unit in rain or in wet locations.
- Your unit should be charged in a location where the temperature is more than 50°F (10°C) but less than 100°F (38°C).

SAFETY WARNINGS FOR CHARGING STANDS AND LEAD-ACID BATTERIES

- Before using charging stand, read all instructions and cautionary markings in this manual, on charging stand, and product using charging stand.
- Do not expose charger to rain or snow.
- To reduce risk of injury, charge only sealed lead-acid rechargeable batteries. Other types of batteries may burst, causing personal injury and damage.

RULES FOR SAFE OPERATION

- To reduce risk of damage to charger body and cord, pull by the charger body, rather than cord, when disconnecting the charger.
- Make sure charger cord is located so that it will not be stepped on, tripped over, or otherwise subjected to damage or stress.
- Do not operate charger with a damaged cord or plug. If damaged, replaced charger immediately.
- Do not operate charger if it has received a sharp blow, been dropped, or otherwise damaged in any way. If the charger case is damaged, replace the charger.
- Do not disassemble charger. The charger is not serviceable; disassembly may result in a risk of electric shock or fire.
- To reduce risk of electric shock, unplug the charger from outlet before attempting any maintenance or cleaning.
- Do not use charger outdoors.
- Use only the following type and size battery: Ryobi part #182391, 12 volt DC, sealed lead-acid battery.
- Do not dispose of batteries in a fire. The cell may explode. Batteries should be recycled, consult your local waste authority for information regarding available recycling and/or disposal options
- Do not charge battery in rain or in wet locations.
- Exercise care when handling batteries in order not to short the battery with conducting materials such as rings, bracelets, and keys. The battery or conductor may overheat and cause burns.
- Charge the battery in a location where the temperature is more than 50°F (10°C) but less than 100°F (38°C).
- Do not open or mutilate the battery. Released electrolyte is corrosive and may cause damage to the eyes or skin. It may be toxic if swallowed.
- Use the right tool. Only use this tool for the purpose intended.
- Do not overreach. Always keep proper footing and balance.
- Do not force the unit. It will do the job better and with less likelihood of a risk of injury at the rate for which it was designed.
- Always hold the unit with both hands when operating. Keep a firm grip on both the battery housing grip and D-handle.
- Use only genuine Ryobi replacement parts when servicing this unit. These parts are available from your authorized service dealer.
- Do not use parts, accessories or attachments not authorized by Ryobi for this unit. Doing so could lead to serious injury to the user, or damage to the unit, and void your warranty.
- The trimmer is designed only for cutting grass, light weeds and decorative trimming. Do not use trimmer as an edger.
- Be sure the cutting attachment is not in contact with anything before starting the unit.
- If you strike or become entangled with a foreign object, stop the unit immediately and check for damage. Do not operate before repairing damage. Do not operate the unit with loose or damaged parts.
- Release the trigger, ensure the lock-off button resets and allow the motor to stop for maintenance or repair.
- Keep hands, face, and feet at a distance from all moving parts. Do not touch or try to stop the cutting attachment when it is rotating.
- Always stop the motor when cutting is delayed or when walking from one cutting location to another.
- The cutting attachment shield must always be in place while operating the unit. Do not operate unit without trimming line extended, and the proper line installed. Do not extend the trimming line beyond the length of the shield.
- Keep unit clean of vegetation and other materials. They may become lodged between the cutting attachment and shield.

WHILE OPERATING

- To avoid accidental starting, never carry your unit with your finger on the trigger.
- Wear safety glasses or goggles that are marked as meeting ANSI Z87.1-1989 standards, and ear/hearing protection when operating this unit. Wear a face or dust mask if the operation is dusty. Long sleeve shirts are recommended.
- Stay Alert. Watch what you are doing. Use common sense.
- Wear heavy, long pants, boots and gloves. Do not wear short pants, sandals or go barefoot.
- Dress Properly. Do not wear loose clothing or jewelry. They can be caught in moving parts. Secure hair above shoulder level.
- Adjust the D-handle to your size to provide the best grip.
- Use the unit only in daylight or good artificial light.

OTHER SAFETY WARNINGS

- Store the unit inside in a dry place, either locked up or up high to prevent unauthorized use or damage. Keep out of the reach of children.
- Never douse or squirt the unit with water or any other liquid. Keep handles dry, clean and free from debris. Clean after each use, see Cleaning and Storage instructions.
- Be sure to secure the unit while transporting.
- Keep these instructions. Refer to them often and use them to instruct other users. If you loan someone this unit, also loan them these instructions.

SAVE THESE INSTRUCTIONS

RULES FOR SAFE OPERATION

SAFETY AND INTERNATIONAL SYMBOLS

This operator's manual describes safety and international symbols and pictographs that may appear on this product. Read the operator's manual for complete safety, assembly, operating and maintenance and repair information.

SYMBOL

MEANING



• SAFETY ALERT SYMBOL

Indicates danger, warning, or caution. May be used in conjunction with other symbols or pictographs.



• WARNING: READ OPERATOR'S MANUAL

Failure to follow operating instructions and safety precautions in the operator's manual can result in serious injury. Read the operator's manual before starting or operating this unit.



• FOR SERVICE INFORMATION, CALL:

USA: 1-800-345-8746
CANADA 1-800-265-6778



• WEAR EYE AND HEARING PROTECTION

WARNING: Thrown objects and loud noise can cause severe eye injury and hearing loss. Wear eye protection meeting ANSI Z87.1-1989 standards and ear protection when operating this unit.



• KEEP BYSTANDERS AWAY

WARNING: Keep all bystanders, especially children and pets, at least 50 feet (15 m.) from the operating area.



• THROWN OBJECTS AND ROTATING CUTTER CAN CAUSE SEVERE INJURY

WARNING: Do not operate without the cutting attachment shield in place. Keep away from the rotating cutting attachment.



• SHARP BLADE

WARNING: Sharp blade on cutting attachment shield. To prevent serious injury, do not touch line cutting blade.



WARNING: The operation of any power tool can cause foreign objects to be thrown into your eyes. This can lead to severe eye damage. Before commencing power tool operation, always wear safety glasses or goggles that are marked as meeting ANSI Z87.1-1989 standards, and a full face shield when needed.

RULES FOR SAFE OPERATION

KNOW YOUR UNIT

APPLICATION

Use the Trimmer for;

- Cutting grass and light weeds, decorative trimming around trees, fences, etc.

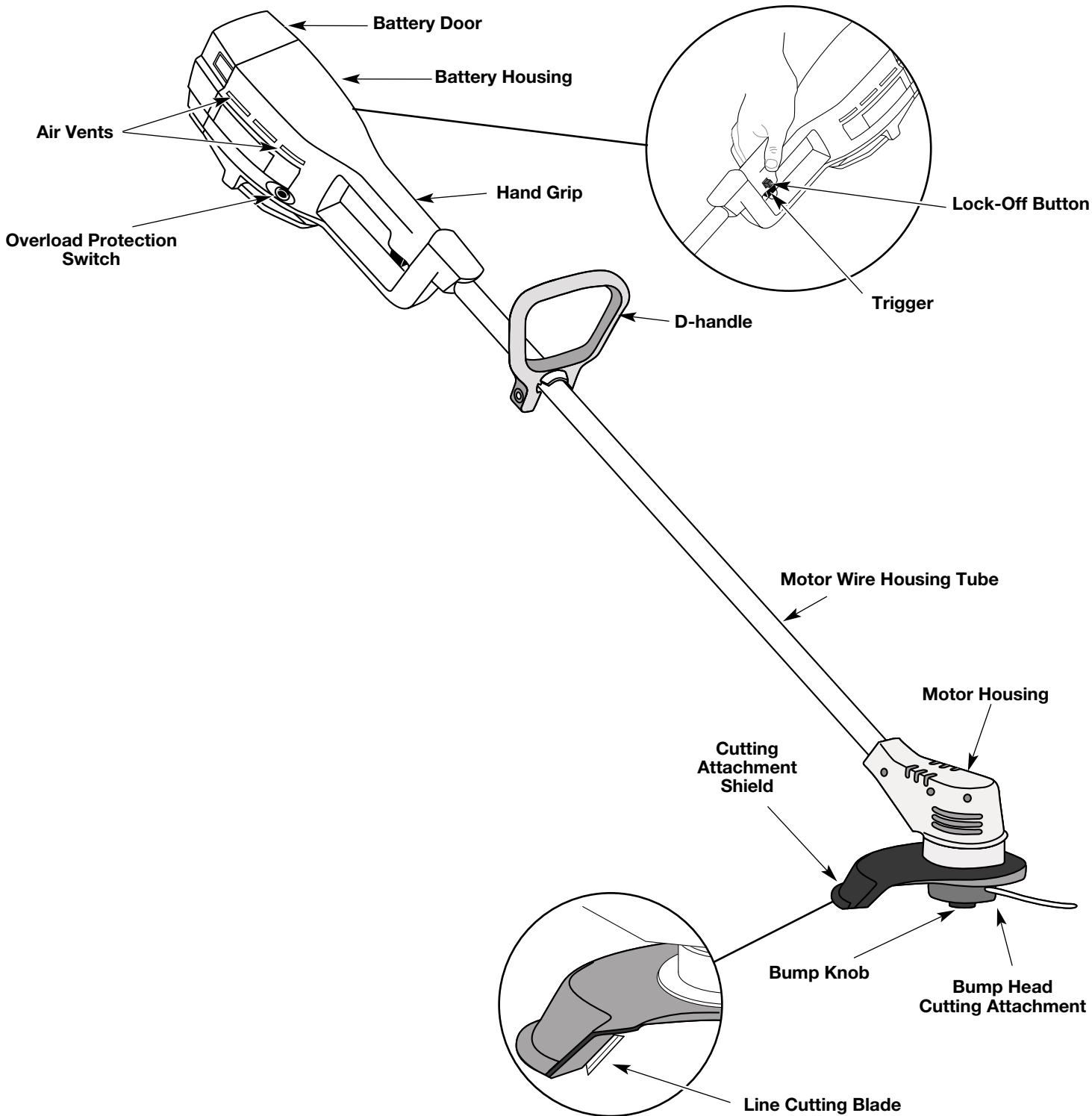

ASSEMBLY INSTRUCTIONS

ADJUSTING THE D-HANDLE

1. Hold the unit in the operating position (Fig. 1).



Fig. 1

2. Loosen the wing nut (Fig. 2). It is not necessary to remove the wing nut, washer or bolt.
3. Position the D-handle to the location that provides you the best grip, and tighten the wing nut (Fig. 2).

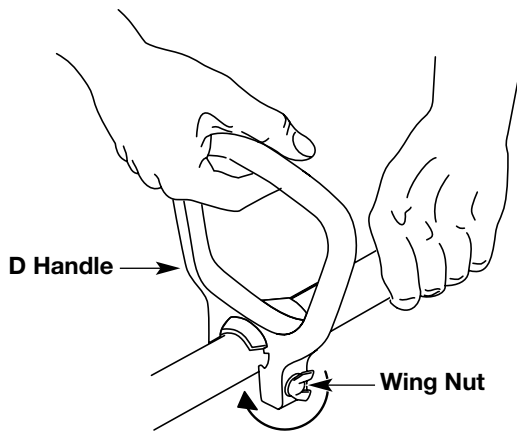

Fig. 2

MOUNTING THE CHARGING STATION

NOTE: Mount the charging unit and allow the unit to charge for at least 36 hours prior to first use.

This unit may stay on the charging station continuously without overcharging. Place the charging station where the unit is intended to be stored. This should be a cool, dry and well ventilated place, where the unit can be locked-up and out of the reach of children.

The unit should be stored and charged in a location where the temperature is between 50°F (10°C) and 100°F (38°C).

1. Locate a place for the charging station near a wall outlet and high enough to keep the unit off the floor.
2. Locate the wall stud and mount the charging station to the wall using the three (3) screws provided (Fig 3). Make sure that the screws enter the wall stud to provide a secure mount.

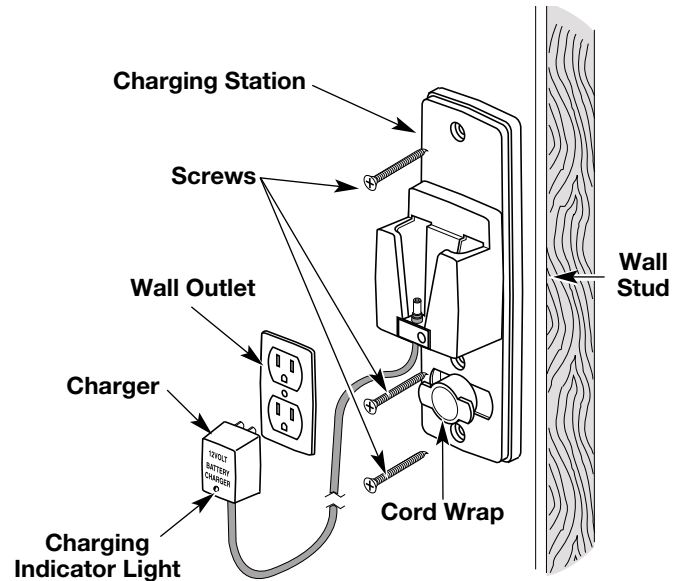

Fig. 3

CAUTION: To prevent injury or damage to the unit, the charging station must be mounted securely to the wall.

3. Plug the charger into the wall outlet and wrap any excess wire onto the cord wrap on the charging station (Fig. 3).

OPERATING INSTRUCTIONS

CHARGING THE UNIT

Make sure the charging station is securely fastened to a wall and the charger is plugged into a working wall outlet.

NOTE: Allow the unit to charge for at least 36 hours prior to first use.

NOTE: If you are using the optional Battery and Charger Accessory Kit to charge your battery. Read and follow all instructions in the manual that comes with the kit to set up and properly charge your battery.

1. Slide the unit down into the charging station until it is firmly seated (Fig. 4). The barrel connector in the charging station will insert into the unit. See **Replacing the Charger** if not, page 14.

NOTE: The battery will heat up while the unit is being charged. Be sure the air vents on the battery housing are kept cleared for proper ventilation (Fig. 4).

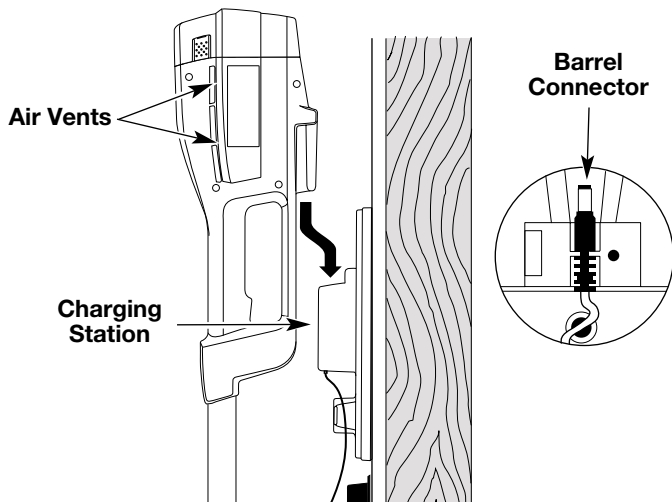



Fig. 4

2. When the red indicator light on the charger is on, the battery is being charged (Fig. 5). If the light fails to come on, check that the:
 - a. Charger is plugged into a working wall outlet.
 - b. Unit is firmly seated into the charging station and the barrel connector is fully inserted into the unit.
 - c. Barrel connector is properly installed in the charging station. See **Replacing the Charger** if not, page 14.
 - d. Power is on at the wall outlet.

NOTE: If the wall outlet is operated by a switch, be sure the switch is ON.

 **WARNING:** To prevent serious personal injury, if the wall outlet is not working properly, have the wall outlet checked by a qualified electrician.

3. Charge the battery until the Charging Indicator Light on the charger turns from red to green (Fig. 5).

NOTE: The unit's operating time and the life of the battery will be shortened if the unit is not fully charged between uses.

4. Place the unit back on the charging station after each use. The unit is designed so that the battery cannot be overcharged.

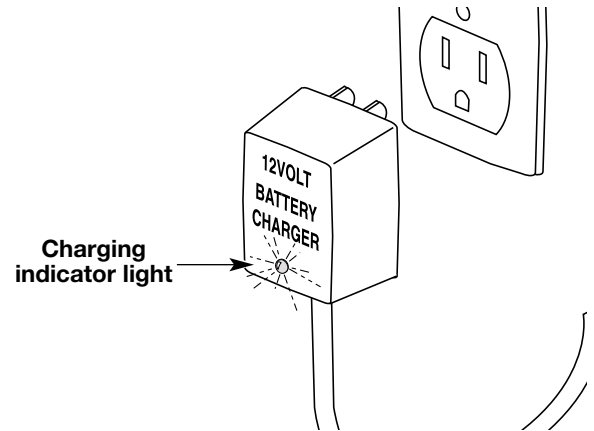

Fig. 5

Charging Tips for Maximum Performance

- Store and charge the unit where temperatures are between 50° F (10° C) and 100° F (38° C). Storing the unit or batteries above 100° F (38° C) will reduce battery life.
- Storage below 50° F (10° C) will not reduce battery life, but may require a longer charging time.
- Store the unit on the charging station when not in use. The unit is designed so that the battery cannot be overcharged.

NOTE: The charging indicator light will remain lit when the unit is properly installed in the charging station.

Temperature Effects on Charging Time

- 50° F (10° C) to 100° F (38° C) – Battery will be charged within 24 hours.
- 40° F (4° C) to 50° F (10° C) – Battery will require up to 48 hours for a full charge.
- Below 40° F (4° C) – Battery will not reach full charge.

NOTE: Unit run time will be reduced when the battery is not fully charged.

OPERATING INSTRUCTIONS

TO START UNIT



WARNING: To prevent serious personal injury, ensure the lock-off button resets each time the trigger is released.

1. Press and hold the lock-off button in (Fig. 6). This allows the trigger to operate.

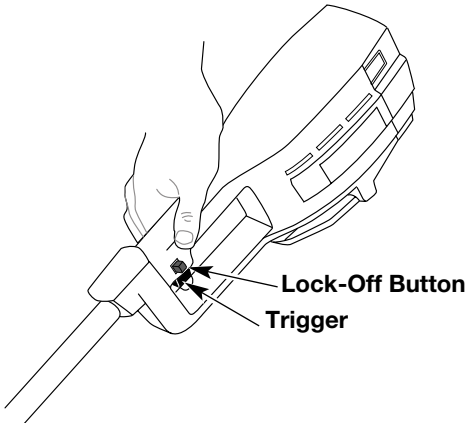

Fig. 6

2. Depress and hold trigger.
3. Release the lock-off button.

TO STOP UNIT

Release the trigger to stop the trimmer.

OVERLOAD PROTECTION SWITCH

This unit is equipped with an overload protection switch to prevent overheating damage to the motor. If the switch pops out:

1. Release the trigger and allow the unit to cool for a minute.
2. Press the overload switch to reset. Resume operation (Fig. 7).

If the switch pops again shortly after the first time:

1. Allow the unit to cool for 15 to 30 minutes.
2. After the unit has cooled, press the overload switch to reset. Resume operation

If the switch does not stay in or continues to pop during operation, take the unit to an authorized service dealer for repair

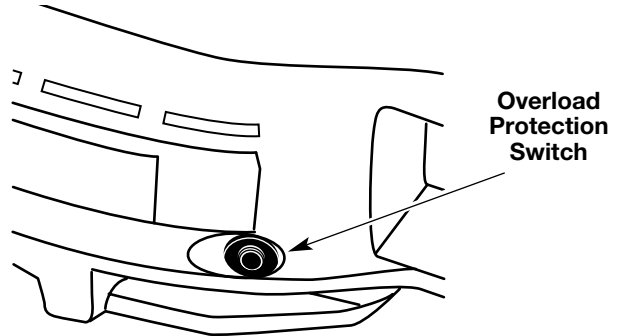

Fig. 7

HOLDING THE UNIT



WARNING: Dress properly to reduce the risk of injury when operating this unit. Do not wear loose clothing or jewelry. Wear eye and ear/hearing protection. Wear heavy, long pants, boots and gloves. Do not wear short pants, sandals or go barefoot.

Before operating the unit, stand in the operating position and check that:

- The operator is wearing eye protection and proper clothing.
- The right arm is slightly bent, the right hand holding the housing grip.
- The left arm is straight, the left hand holding the D-handle.
- The unit is at waist level.



WARNING: To prevent serious injury, do not carry the unit with your finger on the trigger.

- The trimmer bump head is parallel to the ground and easily contacts the material to be cut without the operator having to bend over (Fig. 8).



Fig. 8

OPERATING INSTRUCTIONS

OPERATING THE TRIMMER



WARNING: To avoid serious personal injury, wear goggles or safety glasses at all times when operating this unit. Wear a face mask or dust mask in dusty locations.

Clear the area to be cut before each use. Remove all objects such as rocks, broken glass, nails, wire, or string which can be thrown or become entangled in the cutting attachment. Clear the area of children, bystanders, and pets. At a minimum, keep all children, bystanders and pets outside a 50 feet (15m) radius; there still may be a risk to bystanders from thrown objects. Bystanders should be encouraged to wear eye protection. If you are approached, stop the motor and cutting attachment immediately.

NOTE: Remove protective tape from the line cut-off blade before operating trimmer.

ADJUSTING TRIMMING LINE LENGTH

The bump head allows the operator to release more trimming line without stopping the motor. As line becomes frayed or worn, additional line can be released by lightly tapping the trimming head on the ground while operating the trimmer (Fig. 9).

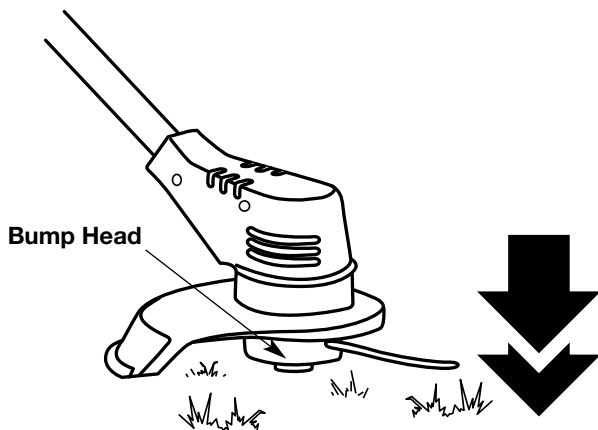

Fig. 9

NOTE: Always keep the trimming line fully extended. Line release becomes more difficult as cutting line becomes shorter.



WARNING: Do not remove or alter the line cutting blade assembly. Excessive line length will cause the motor to overheat and may result in serious personal injury.

Each time the head is bumped, approximately 1 inch (25.4 mm) of trimming line is released. A blade in the string guard will cut the line if excess line is released. For best results, tap the head on bare ground or hard soil. If line release is attempted in tall grass, the motor may overheat. Always keep the trimming line fully extended. Line release becomes more difficult as the cutting line becomes shorter.

DECORATIVE TRIMMING

Decorative trimming is accomplished by removing all vegetation around trees, posts, fences, etc. Use a 30-degree angle when trimming with this method (Fig. 10).

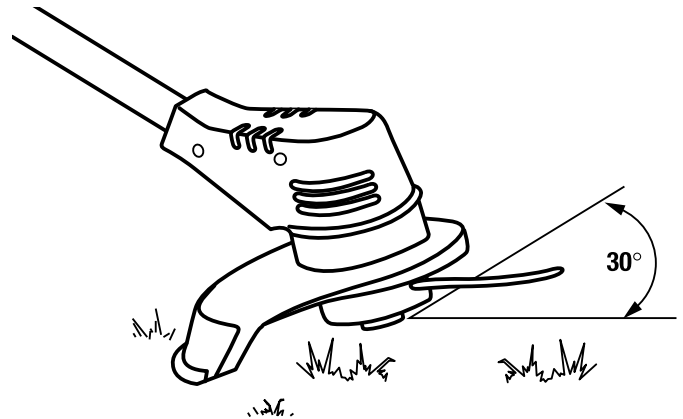

Fig. 10

TIPS FOR BEST TRIMMING RESULTS

- The correct angle for the cutting attachment is parallel to the ground.

NOTE: Do not rest the bump head on the ground.

- DO NOT FORCE THE UNIT. Allow the very tip of the line to do the cutting (especially along walls). Cutting with more than the tip will reduce cutting efficiency and may overload the motor.
- Grass over 8 inches (200 mm) should be cut by working from top to the bottom in small increments to avoid premature line wear or motor drag.
- Whenever possible, cut right to left. When cutting to the left, the unit's cutting efficiency is improved slightly. Also, the clippings are thrown away from the operator.
- Slowly move the trimmer into and out of the area being cut, maintaining the trimmer at the desired cutting height. This can be either a forward-backward or side-to-side motion. Cutting shorter lengths produces best results.
- Trim only when grass and weeds are dry.
- The life of your cutting line is dependent upon following the previous trimming techniques, what is being cut, and where the cutting is being done. For example, the line will wear faster when trimming against a foundation wall as opposed to trimming around a tree. Some line breakage will occur from:
 - Entanglement with foreign matter.
 - Normal line fatigue.
 - Attempting to cut thick, stalky weeds.
 - Forcing the line into objects such as walls or fenceposts

MAINTENANCE AND REPAIR INSTRUCTIONS



WARNING: Battery tools do not have to be plugged into an electrical outlet; therefore, they are always in operating condition. To prevent serious personal injury, take extra precautions and care when performing maintenance, service or for changing the cutting attachment or other attachments.



WARNING: To prevent serious personal injury, remove or disconnect the battery before servicing, cleaning, changing add-on attachments or removing material from the unit.

GENERAL RECOMMENDATIONS

The warranty on this unit does not cover items that have been subjected to operator abuse or negligence. To receive full value from the warranty, the operator must maintain the unit as instructed in this operator's manual.

BEFORE EACH USE CHECK FOR DAMAGED/WORN PARTS

- Bump head — Replace bump head parts that are bent, warped, cracked, or damaged in any way.

AFTER EACH USE CLEAN UNIT AND LABELS

- Clean the unit using a damp cloth with a mild detergent.

NOTE: Do not use any strong detergents on the plastic housing or the handle. They can be damaged by certain household cleaners that contain aromatic oils such as pine and lemon, and by solvents such as kerosene.

- Wipe off the unit with a clean, dry, soft cloth.
- Keep air vents free from debris at all times.

LINE INSTALLATION

Always use genuine Ryobi 0.080 in. (2.03 mm.) replacement line. Using line other than specified may cause the unit to overheat or fail.



WARNING: Never use metal-reinforced line, wire, or rope, etc. These can break off and become a dangerous projectile.

There are two methods to replace the trimmer line:

- Wind the inner reel with new line.
- Install a prewound inner reel.

Winding the Existing Reel

1. Remove the bump head cover by pressing in both bump head cover tabs visible on either side of the bump head outer spool (Fig. 11).

NOTE: The spring will push the cover up when the tabs release.

2. Remove the inner reel and spring (Fig. 11).
3. Use a clean cloth to clean the inner surface of the outer spool (Fig. 11).

NOTE: Always clean the inner reel, outer spool, and shaft before reassembling the bump head.

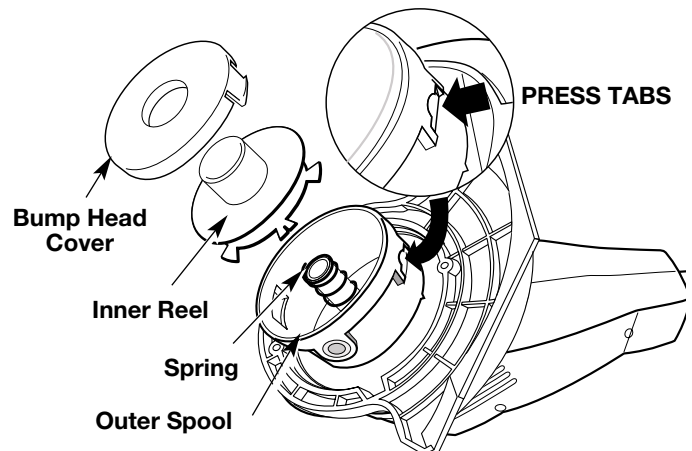

Fig. 11

4. Check the indexing teeth on the inner reel and outer spool for wear (Fig. 12). If necessary, remove burrs or replace the reel and spool.

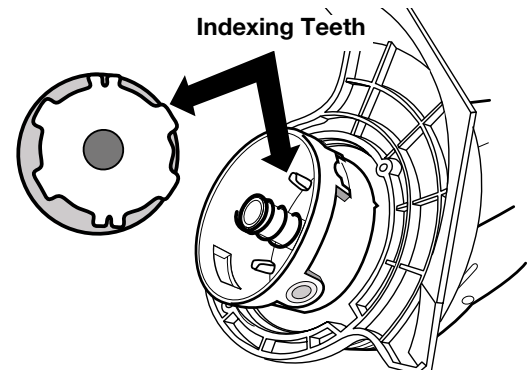

Fig. 12

5. Take approximately 12 feet (3.6 m) of new trimming line, insert one end of the line into the hole in the inner reel (Fig. 13).
6. Wind the line, in even and tight layers, onto the reel (Fig. 13). Wind the line in the direction indicated on the inner reel.

NOTE: Failure to wind the line in the direction indicated will cause the bump head to operate incorrectly.

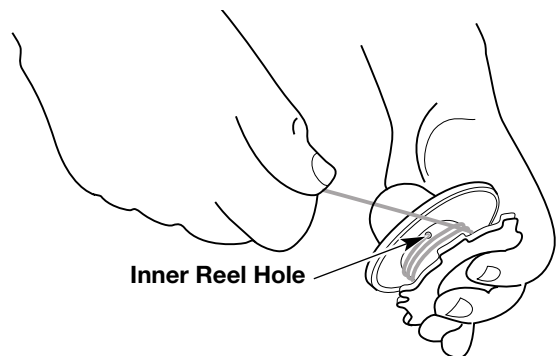

Fig. 13

MAINTENANCE AND REPAIR INSTRUCTIONS

7. Insert the end of the line into one of the two 0.80 holding slots (Fig. 14).

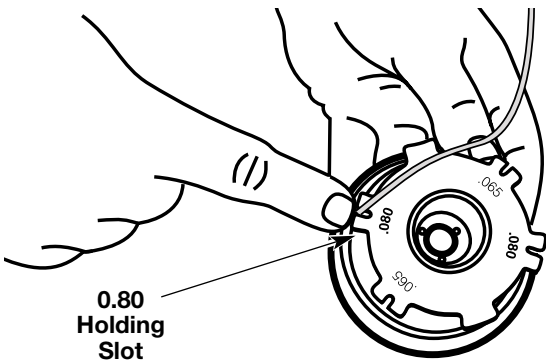

Fig. 14

8. Insert the end of the line through the eyelet in the outer spool (Fig. 15)

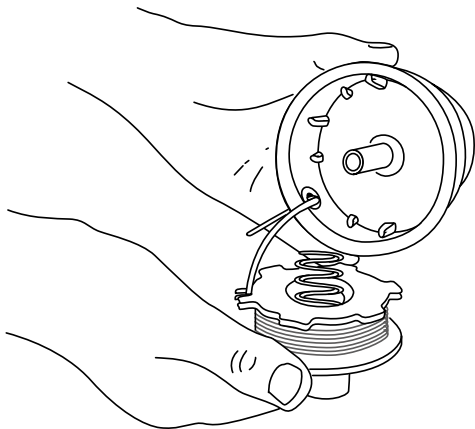

Fig. 15

9. Place inner reel and spring inside the outer spool.

NOTE: The spring must be assembled on the inner reel before reassembling the bump head.

10. Hold the inner reel in place, grasp the line end and pull firmly to release the line from the holding slot in the inner reel (Fig. 16).

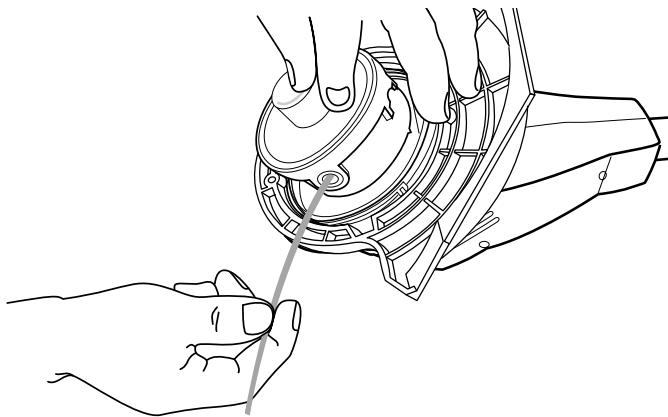

Fig. 16

11. Install the bump head cover over the inner reel. Align the tabs on the cover with the slots in the outer spool and press the cover evenly down until it snaps into place .

NOTE: Make sure the bump head cover tabs snap into place or the inner reel will come out during operation.

INSTALLING A PREWOUND REEL

Always use genuine replacement line. Using larger line than the unit is designed for may make the motor overheat or fail.

1. Remove the bump head cover by pressing in both bump head cover tabs visible on either side of the bump head outer spool (Fig. 11, Pg. 11).

NOTE: The spring will push the cover up when the tabs release.

2. Remove the old inner reel and spring from the outer spool (Fig. 11, Pg. 11).
3. Remove the spring from the old inner reel (Fig. 11, Pg. 11).
4. Use a clean cloth to clean the inner surface of the outer spool (Fig. 11, Pg. 11).
5. Insert the end of the line, on the prewound reel, through the eyelet in the outer spool (Fig. 15)

6. Place inner reel and spring inside the outer spool.

NOTE: The spring must be assembled on the inner reel before reassembling the bump head.

7. Hold the inner reel in place, grasp the line end and pull firmly to release the line from the holding slot in the inner reel (Fig. 16).

8. Install the bump head cover over the inner reel. Align the tabs on the cover with the slots in the outer spool and press the cover evenly down until it snaps into place.

NOTE: Make sure the bump head cover tabs snap into place or the inner reel will come out during operation.

MAINTENANCE AND REPAIR INSTRUCTIONS

BATTERY PACK REPLACEMENT



To preserve natural resources, please recycle or dispose of properly. **THIS PRODUCT CONTAINS A SEALED LEAD-ACID BATTERY AND MUST BE DISPOSED OF PROPERLY.** Local, state, or federal laws may prohibit disposal of sealed lead-acid batteries in ordinary trash. Consult your local waste authority for information regarding available recycling and/or disposal options.

Removing the Battery

1. Push the two latches on the side of the battery housing door in and swing door down. Unhook the door from the slot on the bottom of the battery housing by lifting up and away. Set door aside (Fig. 17).

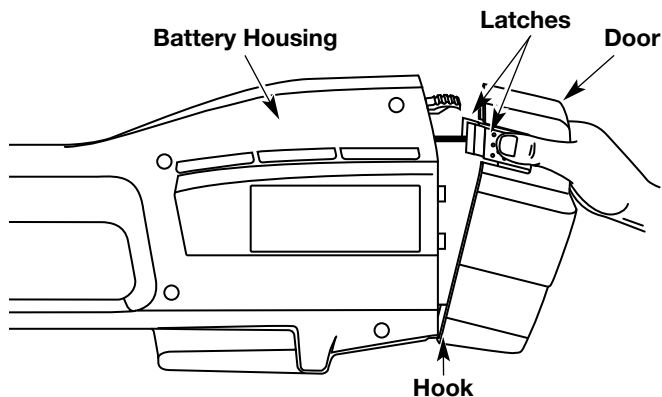

Fig. 17

2. Push down on the battery retaining latch while pulling battery out (Fig. 18).

NOTE: If the battery is removed you will notice grease on the terminal contacts, this is normal.

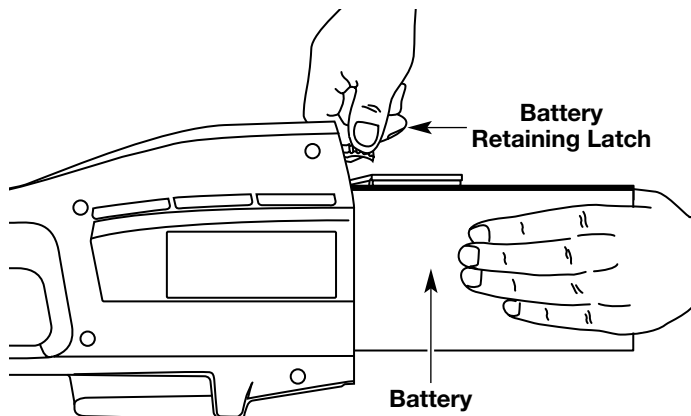

Fig. 18



WARNING: If the battery pack has signs of leakage, do not touch. Do not open or mutilate the battery. Released electrolyte is corrosive and may cause damage to the eyes or skin. To avoid serious injury, take the unit to an authorized service dealer for repair.

Installing the Battery

1. Slide the battery into the battery housing until the battery retaining latch locks the battery into place (Fig 18).
2. Reinstall the door by hooking over the slot on the bottom of the battery housing. Swing the battery housing door closed until the two latches snap into place.

For Best Performance

When reinstalling the battery:

- Check battery terminals for corrosion and clean if necessary. Clean terminals using a dry scrubbing pad and wipe clean with a dry cloth. Never use liquids to clean terminals.
- Check battery casing for signs of damage and replace if needed.

NOTE: If you clean or replace the battery, apply a small amount of electrically conductive grease to the terminals only. This grease is available at any local electronics store.

Do not use automotive or bearing grease.

Recycle the Battery Pack

If you are removing the battery for replacement or for storage, cover the battery pack's terminals with heavy duty electrical tape.



WARNING: Do not attempt to destroy or disassemble battery or remove any of its components. Sealed lead-acid batteries must be recycled or disposed of properly. Never touch both terminals with metal objects and/or body parts as short circuit may result. Keep away from children. Failure to comply with these warnings could result in fire and/or serious personal injury.

MAINTENANCE AND REPAIR INSTRUCTIONS

REPLACING THE CHARGER

Replace the charger if it is damaged, or if the barrel connector or cord become damaged, or if the barrel connector is not connecting to the unit properly.



CAUTION: Only use the type of charger specified for this unit. Any other type may cause damage to the unit, batteries and possible injury.

Your trimmer requires a Ryobi #182534 12V charger and #180295 charging station. The charging instructions refer only to these parts.

NOTE: If you are using the optional Battery and Charger Accessory Kit to charge your battery. Read and follow all instructions in the manual that comes with the kit to set up and properly charge your battery.

1. Unplug the charger from the wall outlet and remove the unit from the charging station.
2. Remove the screw from the clamp holding the barrel connector in place using a standard or T-20 Torx bit screwdriver (Fig. 19).
3. Remove the barrel connector from the slot and replace charger, if needed.
4. Insert the narrow side of the barrel connector wire into the groove in the slot of the charging station. Ensure the barrel connector is inserted correctly and secure (Fig. 19).
5. Reinstall the clamp and screw.
6. Plug the charger into the wall outlet. Refer to **Charging the Unit** for charging instructions.

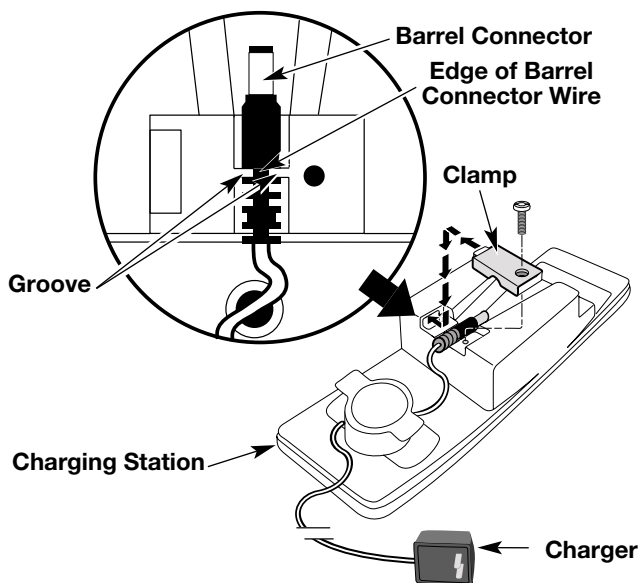

Fig. 19

CLEANING THE UNIT



WARNING: Battery tools do not have to be plugged into an electrical outlet; therefore, they are always in operating condition. To prevent serious personal injury, take extra precautions and care when performing maintenance, cleaning or servicing the unit.



WARNING: To prevent serious personal injury, remove or disconnect the battery before servicing, cleaning, changing add-on attachments or removing material from the unit.

- Clean the unit using a damp cloth with a mild detergent.
- Do not use any strong detergents on the plastic housing or the handle. They can be damaged by certain aromatic oils such as pine and lemon, and by solvents such as kerosene. Moisture can also cause a shock hazard. Wipe off any moisture with a soft dry cloth.
- Use a small brush or the air discharge of a small vacuum cleaner brush to clean the air vents on the battery housing and motor housing.
- Keep the air vents free of obstructions

STORING THE UNIT

Clean the unit thoroughly before storing it. Hang the unit on the charging station. Store the unit in a dry, well-ventilated area, locked-up or up high, out of the reach of children.

To maintain the life of the battery, only store the unit in a place where temperatures do not exceed 100°F or drop below 40°F.

ACCESSORIES AND REPLACEMENT PARTS

| | |
|--|--------|
| Cutting Attachment Shield | 180293 |
| Replacement Line | 610375 |
| Replacement Line Cartridge | 180292 |
| Inner Reel Spring | 180374 |
| Bump Head Cover | 180376 |
| Charger | 182534 |
| Charging Station | 180295 |
| 12 Volt Battery Pack | 182391 |
| Battery and Charger Accessory Kit (optional) | 300028 |

TROUBLESHOOTING

MOTOR OPERATES SLOWLY OR WILL NOT OPERATE

CAUSE

Battery is not charged
Overload protection switch has popped

ACTION

Charge battery. See **Charging the Unit**, page 8.
Reset overload protection switch

BATTERY WILL NOT CHARGE

CAUSE

No power to charger or battery
Battery has failed

ACTION

Check charger and charging station. See **Charging the Unit**, page 8.
Replace battery. See **Battery Pack Replacement**, page 13.

CUTTING ATTACHMENT WILL NOT ADVANCE LINE

CAUSE

Cutting attachment bound with grass
Cutting attachment out of line
Inner reel bound up
Cutting attachment dirty
Line welded
Line twisted when refilled
Not enough line is exposed

ACTION

Stop the unit and clean cutting attachment
Refill with new line
Replace the inner reel
Clean inner reel and outer spool
Disassemble, remove the welded section and rewind the line
Disassemble and rewind the line
Push the Bump Knob and pull out line until 4 inches (102 mm.) of line is outside of the cutting attachment

SPECIFICATIONS

BATTERY AND MOTOR

| | |
|--|---------------------------|
| Motor | 12 Volt DC, 15 Amps |
| Battery | Sealed Lead-Acid, 12 Volt |
| Motor Wire Housing Tube | Aluminum Tube |
| Unit Weight (With battery, cutting attachment shield and D-handle) | 10.2 lbs. (4.63 kg.) |
| Cutting Mechanism | .Bump Head |
| Line Spool Diameter | 3 in (76.2 mm) |
| Trimming Line Diameter | 0.080 in (2.03 mm.) |
| Cutting Path Diameter | 10 in. (254 mm) |

LIMITED TWO-YEAR WARRANTY

RYOBI OUTDOOR PRODUCTS warrants each new RYOBI Product for two (2) years according to the following terms.

This warranty extends to the original retail purchaser only and commences on the date of original retail purchase.

Any part of the RYOBI Product manufactured or supplied by RYOBI and found in the reasonable judgement of RYOBI to be defective in material or workmanship will be repaired or replaced by an authorized RYOBI service dealer without charge for parts and labor.

The RYOBI Product including any defective part must be returned to an authorized service dealer within the warranty period. The expense of delivering the RYOBI Product to the dealer for warranty work and the expense of returning it back to the owner after repair or replacement will be paid for by the owner. RYOBI's responsibility in respect to claims is limited to making the required repairs or replacements and no claim of breach of warranty shall be cause for cancellation or rescission of the contract of sale of any RYOBI Product. Proof of purchase will be required by the dealer to substantiate any warranty claim. All warranty work must be performed by an authorized RYOBI service dealer.

This warranty is limited to ninety (90) days from the date of original retail purchase for any RYOBI Product that is used for rental or commercial purposes, or any other income-producing purpose.

This warranty does not cover any RYOBI Product that has been subject to misuse, neglect, negligence, or accident, or that has been operated in any way contrary to the operating instructions as specified in the RYOBI Operator's Manual. This warranty does not apply to any damage to the RYOBI Product that is the result of improper maintenance or to any RYOBI Product that has been altered or modified so as to adversely affect the product's operation, performance or durability or that has been altered or modified so as to change its intended use. The warranty does not extend to repairs made necessary by normal wear or by the use of parts or accessories which are either incompatible with the RYOBI Product or adversely affect its operation, performance or durability.

In addition, this warranty does not cover:

- A. Wear items - Bump Knobs, Outer Spools, Cutting Line, Inner Reels.

RYOBI reserves the right to change or improve the design of any RYOBI Product without assuming any obligation to modify any product previously manufactured.

ALL IMPLIED WARRANTIES ARE LIMITED IN DURATION TO THE TWO (2) YEAR WARRANTY PERIOD OR NINETY (90) DAYS FOR PRODUCTS USED FOR ANY COMMERCIAL PURPOSE. ACCORDINGLY, ANY SUCH IMPLIED WARRANTIES INCLUDING MERCHANTABILITY, FITNESS FOR A PARTICULAR PURPOSE, OR OTHERWISE, ARE DISCLAIMED IN THEIR ENTIRETY AFTER THE EXPIRATION OF THE APPROPRIATE TWO-YEAR OR NINETY DAY WARRANTY PERIOD. RYOBI'S OBLIGATION UNDER THIS WARRANTY, IS STRICTLY AND EXCLUSIVELY LIMITED TO THE REPAIR OR REPLACEMENT OF DEFECTIVE PARTS, AND ROP DOES NOT ASSUME OR AUTHORIZE ANYONE TO ASSUME FOR THEM ANY OTHER OBLIGATION. SOME STATES DO NOT ALLOW LIMITATIONS ON HOW LONG AN IMPLIED WARRANTY LASTS, SO THE ABOVE LIMITATION MAY NOT APPLY TO YOU.

RYOBI ASSUMES NO RESPONSIBILITY FOR INCIDENTAL, CONSEQUENTIAL OR OTHER DAMAGES INCLUDING, BUT NOT LIMITED TO EXPENSE OF RETURNING THE RYOBI PRODUCT TO AN AUTHORIZED SERVICE DEALER AND EXPENSE OF DELIVERING IT BACK TO THE OWNER, MECHANIC'S TRAVEL TIME, TELEPHONE OR TELEGRAM CHARGES, RENTAL OF A LIKE PRODUCT DURING THE TIME WARRANTY SERVICE IS BEING PERFORMED, TRAVEL, LOSS OR DAMAGE TO PERSONAL PROPERTY, LOSS OF REVENUE, LOSS OF USE OF THE PRODUCT, LOSS OF TIME, OR INCONVENIENCE. SOME STATES DO NOT ALLOW THE EXCLUSION OR LIMITATION OF INCIDENTAL OR CONSEQUENTIAL DAMAGES, SO THE ABOVE LIMITATION OR EXCLUSION MAY NOT APPLY TO YOU.

This warranty gives you specific legal rights, and you may also have other rights which vary from state to state.

This warranty applies to all RYOBI Products manufactured by RYOBI and sold in the United States and Canada.

To locate your nearest service dealer dial 1-800-345-8746 in the United States or 1-800-265-6778 in Canada.

RYOBI®

RYOBI OUTDOOR PRODUCTS

550 N. 54th Street
Chandler, AZ 85226 U.S.A.

RYOBI CANADA INC.

275 Industrial Rd
Cambridge, Ontario N1R 6K2 CANADA

SAVE THESE INSTRUCTIONS FOR FUTURE REFERENCE.

FOR QUESTIONS CALL 1-800-345-8746 IN U.S.

OR 1-800-265-6778 IN CANADA

**OPERATOR'S MANUAL PART NO. 182284
PRINTED IN U.S.A.**

**REV. B (51535)
1/00**

Free Manuals Download Website

<http://myh66.com>

<http://usermanuals.us>

<http://www.somanuals.com>

<http://www.4manuals.cc>

<http://www.manual-lib.com>

<http://www.404manual.com>

<http://www.luxmanual.com>

<http://aubethermostatmanual.com>

Golf course search by state

<http://golfingnear.com>

Email search by domain

<http://emailbydomain.com>

Auto manuals search

<http://auto.somanuals.com>

TV manuals search

<http://tv.somanuals.com>