

WARNING: If the information in this manual is not followed exactly, a fire or explosion may result causing property damage, personal injury or loss of life.

- Do not store or use gasoline or other flammable vapors and liquids or other combustible materials in the vicinity of this or any other appliance. To do so may result in an explosion or fire.
- **WHAT TO DO IF YOU SMELL GAS**
 - Do not try to light any appliance.
 - Do not touch any electrical switch; do not use any phone in your building.
 - Immediately call your gas supplier from a neighbor's phone. Follow the gas supplier's instructions.
 - If you cannot reach your gas supplier, call the fire department.
- Installation and service must be performed by a qualified installer, service agency or the gas supplier.

CAUTIONS: Propane gas is heavier than air and sinks to the ground. Exercise extreme care in lighting heater in confined areas.

Do not use this boiler if any part has been under water. Immediately call a qualified service technician to inspect the boiler and to replace any part of the control system and any gas control which has been under water.

Should overheating occur or the gas supply fail to shut off, do not turn off or disconnect the electrical supply to the pump. Instead, shut off the gas supply at a location external to the appliance.

Raypak recommends that this manual be reviewed thoroughly before installing your Raypak Boiler. If there are any questions which this manual does not answer please contact your local Raypak representative or the factory.

OPERATING CONTROLS

Model W1 with On/Off Controls

The boiler is equipped with an adjustable tankstat. Set dial for desired temperature.

Models with Mechanical Modulation: H1, H5, W2, N, R

Sizes 133 through 1826. These boilers are equipped with modulating gas valves. They have one or more valves in addition to the main electric gas valve. Their purpose is to adjust the firing rate to meet the required load. The modulator will throttle the boiler input to meet the system demand. The valve has a remote capillary bulb immersed in a well at the header outlet to maintain a constant outlet water temperature. When multiple valves are furnished, they can be staged to give greater flexibility of control. Consult the dial setting tag attached to the control for your desired water temperature.

MODULATING VALVE CHART —7000

DIAL POSITION	TEMPERATURE —°F	
	N W	H R
Lo	110	150
1	117	157
2	124	164
3	130	170
4	137	177
5	143	183
6	150	190
7	156	196
8	163	203
Hi	170	210

MODULATING VALVE (ROBERTSHAW)

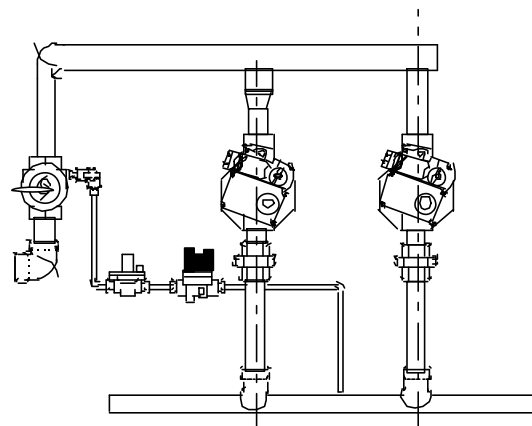
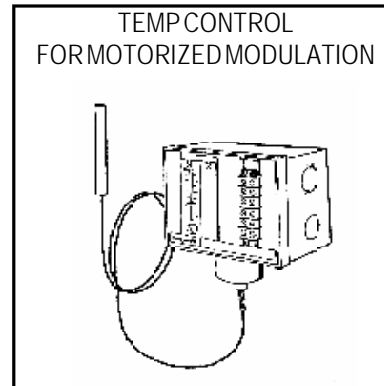
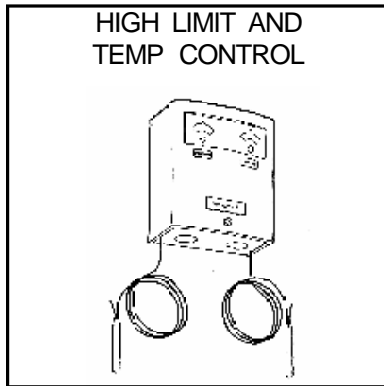

Fig. #8936.1

Models with Motorized Modulation: H2, H6, W2

Sizes 2100-4001 are equipped with a single motorized modulating valve controlled by a temperature controller that offers full modulation down to 20% of rated input BTU.



LIMIT CONTROLS

1. HIGH LIMIT

If boiler is equipped with a manual reset High Limit, push the reset button and set the Limit(s) to 30° - 40°F above operating temperature.

2. FLOW SWITCH

Dual purpose control shuts off boiler in case of pump failure or low water condition.

3. 100% PILOT SAFETY

All standard boilers above 400,000 BTUH input are equipped with pilot safety(ies), which close the main valve within 8/10 of a second whenever the pilot flame is interrupted. Pilot flame is automatically lit when the device is powered. Unit performs its own safety check and opens the main valve only after the pilot is proven to be lit.

4. LOW WATER CUTOFF

The low water cut off automatically shuts down burner whenever water level drops below probe. 90 second time delay prevents premature lockout due to temporary conditions such as power failure or air pockets.

5. HIGH AND LOW GAS PRESSURE SWITCHES

These switches sense either high or low gas pressures and automatically shut down burners if abnormal pressures exist.

6. BLOCKED VENT SHUT-OFF SYSTEM

All indoor boilers below 300,000 BTUH input employ a blocked vent shut-off system designed to shut off main burner gas in the event the venting system is totally blocked.

In the event the blocked vent shut-off system is actuated, do not attempt to place the boiler in operation, but contact a qualified service agency.

7. FLAME ROLL-OUT SAFETY SHUT-OFF SYSTEM

All boilers below 300,000 BTUH input employ a flame roll-out safety shut-off system designed to shut-off the main burner gas in the event of sustained flame roll-out.

In the event the flame roll-out safety system is actuated, do not attempt to place the boiler in operation, but contact a qualified service agency

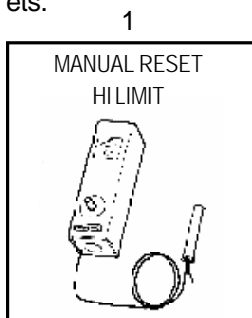

Fig #9314

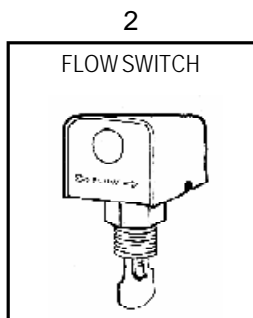

Fig #9317

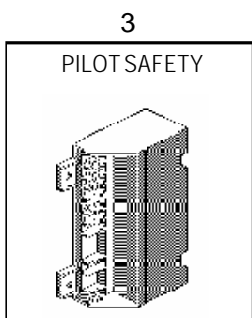

Fig #8929

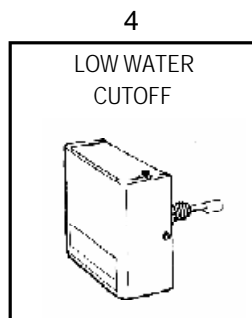

Fig #9316

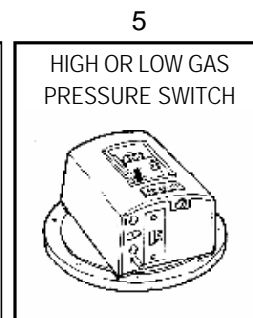

Fig #9312

GENERAL LOCATION OF CONTROLS

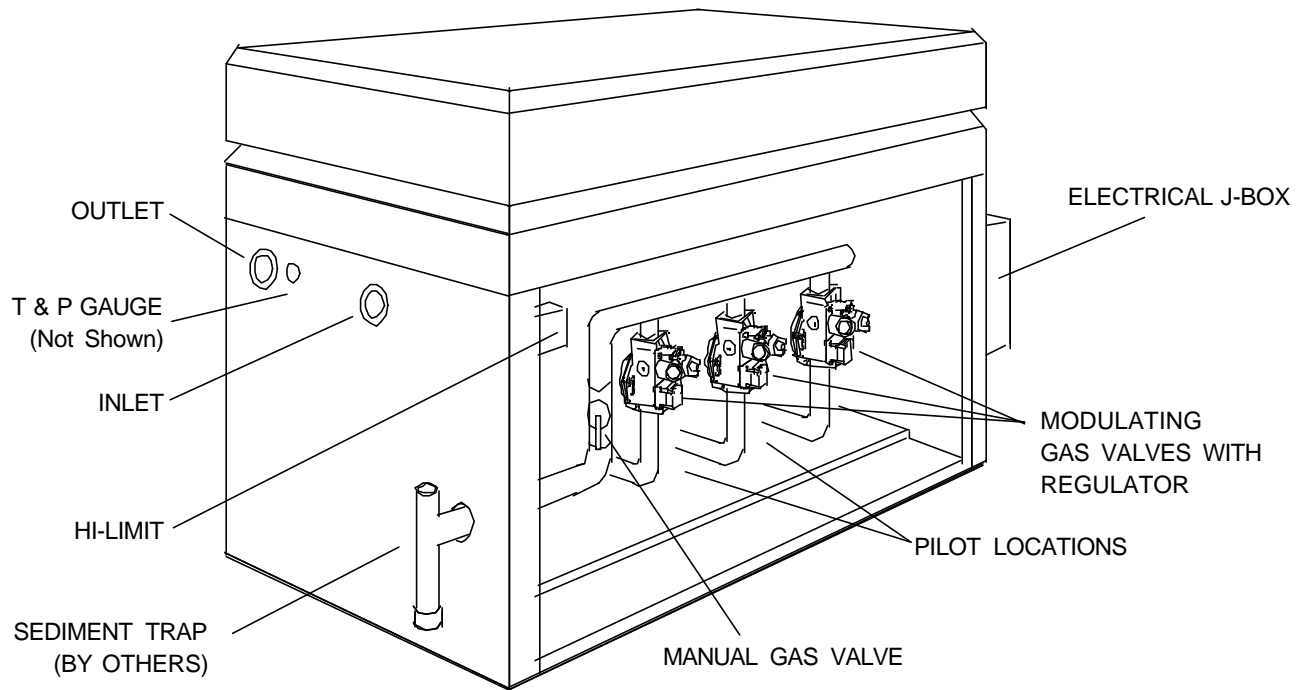

FIG.#S8185.0

START-UP PROCEDURE

GENERAL

Before lighting a new installation, water should be flowing through the heater.

CAUTION: Propane gas is heavier than air and sinks to the ground. Exercise extreme care in lighting heater in confined areas.

INITIAL START-UP – PUMP AND MOTOR

Many pumps are now direct drive. They have no coupler or bearing assembly. These pumps do not require lubrication. Others require SAE-30 non-detergent oil to lubricate both the motor and the bearing assembly. Consult motor manufacturer's instructions.

Clean dust and lint from pump and motor. Check pump coupler and tighten if necessary.

Flush system before putting into operation to assure that foreign material does not damage pump seals.

CAUTION:

- A. Pump must be off to check oil in bearing assembly.
- B. Do not run pump without water in system.

LIGHTING INSTRUCTIONS

BOILERS WITH MANUALLY LIT PILOTS

FOR YOUR SAFETY READ BEFORE OPERATING

WARNING: If you do not follow these instructions exactly, a fire or explosion may result causing property damage, personal injury or loss of life.

- A. This appliance has a pilot which must be lighted by hand. When lighting the pilot, follow these instructions exactly.
- B. BEFORE LIGHTING Smell all around the appliance area for gas. Be sure to smell next to the floor because some gas is heavier than air and will settle on the floor.

WHAT TO DO IF YOU SMELL GAS

- * Do not try to light any appliance.
 - * Do not touch any electric switch:
 - * Do not use any phone in your building.
 - * Immediately call your gas supplier from a neighbor's phone. Follow the gas supplier's instructions.
 - * If you cannot reach your gas supplier, call the fire department.
- C. Use only your hand to push in or turn the gas control knob. Never use tools. If the knob will

not push in or turn by hand, do not try to repair it, call a qualified service technician. Force or attempted repair may result in a fire or explosion.

- D. Do not use this appliance if any part has been under water. Immediately call a qualified service technician to inspect the appliance and to replace any part of the control system and any gas control which has been under water.

LIGHTING INSTRUCTIONS

1. STOP! Read the safety information above.
2. Set the thermostat on the lowest setting.
3. Turn off all electric power to the appliance.
4. Remove boiler door panel.
5. Push in gas control knob slightly and turn clockwise  to "OFF".

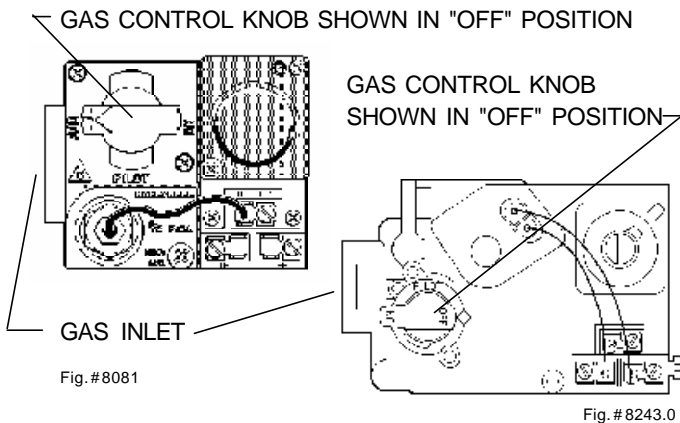

NOTE: Knob cannot be turned from "PILOT" to "OFF" unless knob is pushed in slightly. Do not force.

6. Wait five (5) minutes to clear out any gas. Then smell for gas, including near the floor. If you smell gas, STOP! Follow "B" in the safety information above on this label. If you don't smell gas, go to the next step.
7. Locate pilot mounted on the burner drawer.
8. Turn knob on gas control counter clockwise  to "PILOT".

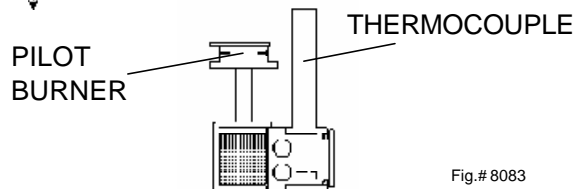

9. Push in control knob all the way and hold in. Immediately light the pilot with a match. continue to hold the control knob in for about one (1) minute after the pilot is lit. Release knob and it will pop back up. Pilot should remain lit. If it

goes out, repeat steps 5 through 9.

- * If knob does not pop up when released, stop and immediately call your service technician or gas supplier.
 - * If the pilot does not stay lit after several tries, turn the gas control knob to "OFF" and call your service technician or gas supplier.
10. Stand to the side of the boiler and turn the gas control knob counter clockwise  to "ON".
 11. Replace boiler door panel.
 12. Turn on all electric power to the appliance.
 13. Set the thermostat to the desired setting.

TO TURN OFF GAS TO APPLIANCE

1. Set the thermostat to the lowest setting.
2. Turn off all electric power to the appliance.
3. Remove boiler door.
4. Push in the gas control knob slightly and turn clockwise to  "OFF". Do not force.
5. Replace boiler door panel.

BOILERS WITH AUTOMATICALLY LIT IID PILOTS AND MANUAL GAS VALVES

FOR YOUR SAFETY READ BEFORE OPERATING

WARNING: If you do not follow these instructions exactly, a fire or explosion may result causing property damage, personal injury or loss of life.



- A. This appliance is equipped with an ignition device which automatically lights the pilot. Do not try to light the pilot by hand.
- B. BEFORE OPERATING Smell all around the appliance area for gas. Be sure to smell next to the floor because some gas is heavier than air and will settle on the floor.

WHAT TO DO IF YOU SMELL GAS

- * Do not try to light any appliance.
 - * Do not touch any electric switch: do not use any phone in your building.
 - * Immediately call your gas supplier from a neighbor's phone, follow the gas supplier's instructions.
 - * If you cannot reach your gas supplier, call the fire department.
- C. Use only your hand to push in or turn the gas control knob. Never use tools. If the knob will not push in or turn by hand, do not try to repair it, call a qualified service technician.
 - D. Do not use this appliance if any part has been under water. Immediately call a qualified service

technician to inspect the appliance and to replace any part of the control system and any gas control which has been under water.

LIGHTING INSTRUCTIONS

1. STOP! Read the safety information above.
2. Set the thermostat on the lowest setting.
3. Turn off all electric power to the appliance.
4. This appliance is equipped with an ignition device which automatically lights the pilot. Do not try to light the pilot by hand.
5. Remove boiler door panel.
6. Turn gas control knob clockwise  to "OFF". Make sure knob rest against stop.
7. Wait five (5) minutes to clear out any gas. Then smell for gas, including near the floor. If you smell gas, STOP! Follow "B" in the safety information above on this label. If you don't smell gas, go to the next step.
8. Turn gas control knob counter clockwise  to "OFF" until it stops. Push in gas control knob and continue rotating counter clockwise  to "ON" position. Make sure knob rest against stop.

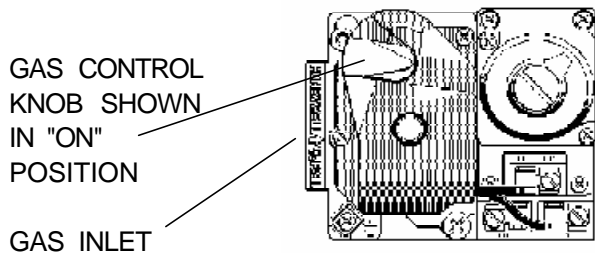



Fig.# 8082

9. Replace boiler door panel.
10. Turn on all electric power to the appliance.
11. Set thermostat to desired setting.
12. If the appliance will not operate, follow the instructions "TO Turn Off Gas To Appliance" and call your service technician or gas supplier.

TO TURN OFF GAS TO APPLIANCE

1. Set the thermostat to the lowest setting.
2. Turn off all the electric power to the appliance if service is to be performed.
3. Remove boiler door panel.
4. Turn gas control knob clockwise  to "OFF". Make sure knob rest against stop.
5. Replace boiler door panel.

BOILERS WITH AUTOMATICALLY LIT IID PILOTS AND AUTOMATIC GAS VALVES

Lighting Instructions

1. Close all gas valves. Turn off electric power supply. Wait 5 minutes.
2. Open manual pilot valve. Turn on electric power. Pilot is automatically lighted.
3. Open main gas valve.
4. Set temperature controls to desired temperature.

To Shut Down

Close all manual gas valve. Turn off electric power.

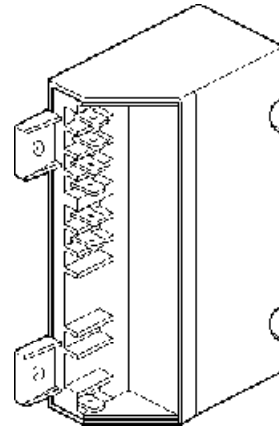

Fig. #8929.1

IGNITION MODULE

BOILERS WITH AUTOMATICALLY LIT C2/IRI PILOT AND MANUAL GAS VALVES

FOR YOUR SAFETY READ BEFORE OPERATING

WARNING: If you do not follow these instructions exactly, a fire or explosion may result causing property damage, personal injury or loss of life.



- A. This appliance is equipped with an ignition device which automatically lights the pilot. Do not try to light the pilot by hand.
- B. BEFORE OPERATING Smell all around the appliance area for gas. Be sure to smell next to the floor because some gas is heavier than air and will settle on the floor.

WHAT TO DO IF YOU SMELL GAS

- * Do not try to light any appliance.
- * Do not touch any electric switch: do not use any phone in your building.
- * Immediately call your gas supplier from a neighbor's phone, follow the gas supplier's instructions.
- * If you cannot reach your gas supplier, call the fire department.

- C. Use only your hand to push in or turn the gas control knob. Never use tools. If the knob will not push in or turn by hand, do not try to repair it, call a qualified service technician. Force or attempted repair may result in a fire or explosion.
- D. Do not use this appliance if any part has been under water. Immediately call a qualified service technician to inspect the appliance and to replace any part of the control system and any gas control which has been under water.

LIGHTING INSTRUCTIONS

1. STOP! Read the safety information.
2. Set the thermostat on the lowest setting.
3. Turn off all electric power to the appliance.
4. This appliance is equipped with an ignition device which automatically light the pilot. Do not try to light the pilot by hand.
5. Remove boiler door panel.
6. Turn gas control knob clockwise  to "OFF". Make sure knob rest against stop.
7. Wait five (5) minutes to clear out any gas. Then smell for gas, including near the floor. If you smell gas, STOP! Follow "B" in the safety information above on this label. If you don't smell gas, go to the next step.
8. Turn gas knob counter clockwise  from "OFF" until it stops. Push in gas control knob and continue rotating counter clockwise  to "ON" position. Make sure knob rest against stop.
9. Replace boiler door panel.

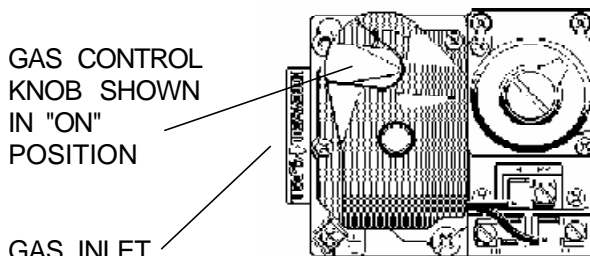



Fig.# 8082

10. Turn on all electric power to the appliance.
11. Push in and release electric control reset button (center of control cover). Pilot is automatically lighted.
12. Set thermostat to desired setting.
13. If the appliance will not operate, follow the instructions "To Turn Off Gas To Appliance" and call your service technician or gas supplier.

TO TURN OFF GAS TO APPLIANCE

1. Set the thermostat to the lowest setting.

2. Turn off all the electric power to the appliance if service is to be performed.
3. Remove boiler door panel.
4. Turn gas control knob clockwise  to "OFF". Make sure knob rest against stop.
5. Replace boiler door panel.

BOILERS WITH AUTOMATICALLY LIT C2/IRI PILOT AND AUTOMATIC GAS VALVES

1. Close all gas valves. Turn off electric power supply. Wait five (5) minutes.
2. Open manual pilot valve. Turn on electric power. Push and release electric control reset button (Center of control cover). Pilot is automatically lighted.
3. Open main gas valve.
4. Set temperature controls to desired temperature.

To Shut Down

Close all manual gas valves. Turn off electric power.

FLAME SAFETY CONTROL RELAY

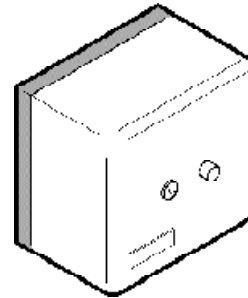

Fig.# 9318

INSPECTION PROCEDURES

BURNERS

Clean main burners and air louvers of dust, lint and debris. Keep boiler area clear and free from combustibles and flammable liquids. Do not obstruct the flow of combustion and ventilating air. Make visual check of burner and pilot flame. Yellow flame indicates clogging of air openings. Lifting or blowing flame indicates high gas pressure. Low flame indicates low gas pressure.

NOTE: *Modulating burner flame varies in height from approximately 1/4" at low fire to approximately 3" at high fire.*

CONTROLS

Check all controls to see that they are operational. To check IID's electronic safety, turn off main burner.

Observe pilot burner when shutting off pilot gas. Ignition spark should go on. Main gas valve will also drop out.

High Limit Switch - to check high limit switch, turn dial setting down to a point slightly below the temperature of the water leaving the boiler. The reset button should snap out and the burner should shut off. Reset dial to 190° F and push reset button. Burner should light.

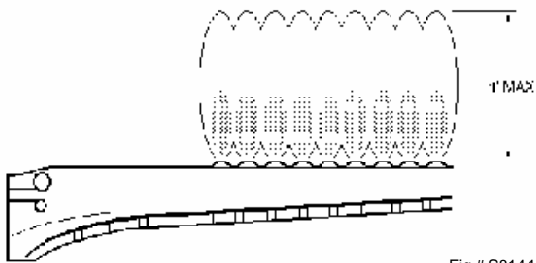

MAIN BURNER FLAME

NORMAL INSPECTION PROCEDURES

First and third month after initial start up and then on an annual basis. If problems are found, refer to Trouble Shooting guide for additional directions.

1. Remove top of boiler and inspect heat exchanger for soot and examine venting system.
2. Remove rear header and inspect for scale deposits.
- *3. Inspect pilot and main burner flame and firing rate.
- *4. Inspect and operate all controls and gas valve.
- *5. Visually inspect system for water leaks.
- *6. A. Oil pump motor and bearing assembly, if oil cups are provided.
B. Disconnect pump from header and check condition of pump impeller. Check condition of bearing by attempting to move impeller from side to side. Replace any parts showing wear.
C. Check pump coupler for wear and vibration.
7. Check flow switch paddle.
8. Clean room air intake openings to assure adequate flow of combustion and ventilation air.
9. Keep boiler area clear and free from combustible materials, gasoline, and other flammable vapors and liquids.

*Should be checked monthly. (Takes approximately 15 minutes).

When ordering parts, you must specify Model and Serial number of boiler. When ordering under warranty conditions, you must also specify date of installation.

RAYPAK HEATING AND HOT WATER SUPPLY EQUIPMENT LIMITED WARRANTY

SCOPE: Raypak, Inc. ("Raypak") warrants to the original owner that all parts of this boiler which are actually manufactured by Raypak will be free from failure under normal use and service for the specified warranty periods and subject to the conditions set forth in this Warranty. Labor charges and other costs for parts removal or reinstallation, shipping and transportation are not covered by this Warranty but are the owner's responsibility.

HEAT EXCHANGER WARRANTY: Five (5) Years from date of boiler installation. This includes only the copper, bronze and cast iron waterways. Twenty (20) Years from date of boiler installation against "Thermal Shock" (excluded, however, if caused by boiler operation at large changes exceeding 150°F between the water temperature at intake and boiler temperature, or operating at boiler temperatures exceeding 230°F).

ANY OTHER PART MANUFACTURED BY RAYPAK:

One (1) Year warranty from date of boiler installation, or eighteen (18) months from date of factory shipment based on Raypak's records, whichever comes first. **SATISFACTORY PROOF OF INSTALLATION DATE, SUCH AS INSTALLER INVOICE, IS REQUIRED. THIS WARRANTY WILL BE VOID IF THE BOILER RATING PLATE IS ALTERED OR REMOVED.**

Examples of misuse or neglect include, but are not limited to, physical damage from external force, not following installation instructions, leaving door off for extended periods, location near corrosive gases, pump (when supplied by us), not lubricated in accordance with listed instructions, etc.

CORPORATE HEADQUARTERS:

RAYPAK, INC.

31111 Agoura Road
Westlake Village, CA 91361
(818) 889-1500
FAX (818) 889-4522
www.raypak.com



www.raypak.com



Raypak, Inc., 31111 Agoura Road, Westlake Village, CA 91361-4699
(818) 889-1500 FAX (818) 889-4522
Litho In U.S.A.

Free Manuals Download Website

<http://myh66.com>

<http://usermanuals.us>

<http://www.somanuals.com>

<http://www.4manuals.cc>

<http://www.manual-lib.com>

<http://www.404manual.com>

<http://www.luxmanual.com>

<http://aubethermostatmanual.com>

Golf course search by state

<http://golfingnear.com>

Email search by domain

<http://emailbydomain.com>

Auto manuals search

<http://auto.somanuals.com>

TV manuals search

<http://tv.somanuals.com>