

SxS Refrigeration

Users Guide

& Installation & Service Instructions

U109200-03



www.rangemaster.co.uk

Contents

Introduction	1
Before you start	1
Positioning Your Appliance	2
About Your Appliance	4
Before Using Your Appliance	5
The Control Panel	6
Storing fresh foods	7
Freezing fresh foods	7
Storage areas	8
Using the Icemaker & Water Dispenser	10
Automatic defrosting	13
Maintenance and Cleaning	13
Troubleshooting	15
Warranty/After Sales Service	16

Introduction

Thank you for buying this high quality appliance, we hope that it provides you with a stylish, yet practical solution to your cooling needs. We hope that this handbook supplies you with all the information you require, but please contact us if there is any thing you are unsure of using the Customer Care Centre number on page 28 of this handbook.

⚠ Warning: This appliance must be earthed.

⚠ Always make sure a qualified person installs this appliance.

The freezer compartment is rated at 3 stars.

Important

Please be aware that this appliance is for domestic use only.

The right hand side of this appliance is a refrigerator, and should be used for storing fresh foods.

The left hand side of this appliance is used for freezing fresh foods and storing frozen foods (convenience meals etc.)

These instructions are intended for the user. They describe the appliance and how to use it safely and correctly.

Before you start

- Before you plug the appliance into the mains, clean the inside of the appliance using warm water and bicarbonate of soda, then dry thoroughly.
- Please leave the appliance to stand for at least six hours. This will allow the cooling system to settle following transportation.
- Check that no parts of the appliance are damaged, especially parts of the cooling system, pipes or leads. If damage has occurred, **DO NOT** install the appliance, you should contact a qualified service engineer or return the appliance to its place of purchase.
- If the accessories inside the appliance have been disturbed during transit, reposition them in accordance with the instructions.

Make sure that the electrical supply to your plug socket is correct for this appliance – The required information is on the data badge of the appliance.

Once the appliance is installed, cleaned and dry, it is ready to be plugged in and switched on.

Safety

The data badge is located inside the appliance (refrigeration compartment).

⚠ WARNING: Use potable (drinking) water with this appliance.

⚠ WARNING: Keep this appliance clear of any obstruction

⚠ DO NOT damage the refrigerant circuit. If it does become damaged, do not use the appliance.

⚠ WARNING: Do not use mechanical devices (i.e. hair dryers) to defrost this appliance.

- When replacing old appliances, make sure that you have disabled any locking mechanisms before disposal – It may even be best to remove the appliance door completely, to prevent children from becoming trapped inside the appliance.
- The appliance must be connected to the power supply safely. Loose connections, broken plugs and bare wires are a safety hazard. Make sure that all connections are sound.
- Before undertaking any routine maintenance or minor repairs, disconnect the appliance from the electrical supply. This includes cleaning, defrosting and changing light bulbs.
- Do not touch cold surfaces of the appliance while it is in use as this will cause hands to stick to them leading to freezer burns.
- When moving the appliance take care not to damage the leads, pipes or condenser unit. Should these parts become damaged, contact a qualified service engineer.
- Effervescent liquids (fizzy drinks) should never be frozen. These liquids expand during freezing and this may lead to the bottles/containers shattering or exploding.
- Foods that are intended to be defrosted or cooked first e.g. breads, meats etc., must not be eaten in their frozen state.
- If food looks or smells strange, do not attempt to eat it. If in doubt throw it away. Spoiled food can be harmful to your health.
- Never use electrical devices, such as hair dryers, to defrost this appliance.
- Never use sharp, metal implements to scrap ice off the surface of this appliance. Only use implements, which are fit for this purpose (i.e. plastic scrapers) and use carefully to avoid damaging the lining of the appliance.
- The cooling system contains refrigerant and oils, all of which are harmful to health if leaked. Should leakage occur, disconnect the appliance and ventilate the room it is installed in. Take care to ensure that you do not get any coolant near to, or in, your eyes.
- Contact a service engineer or arrange to have the appliance removed. Do not use the appliance under any circumstances.

Positioning Your Appliance

Choosing the right location

This appliance should be installed in a room, which is dry and well ventilated.

In order to ensure adequate ventilation, the appliance should be at least 1.5cm clear on all sides from kitchen cabinetry, and any units placed above the appliance must be clear by 1.5cm – allowing adequate ventilation for the appliance. See clearance diagram.

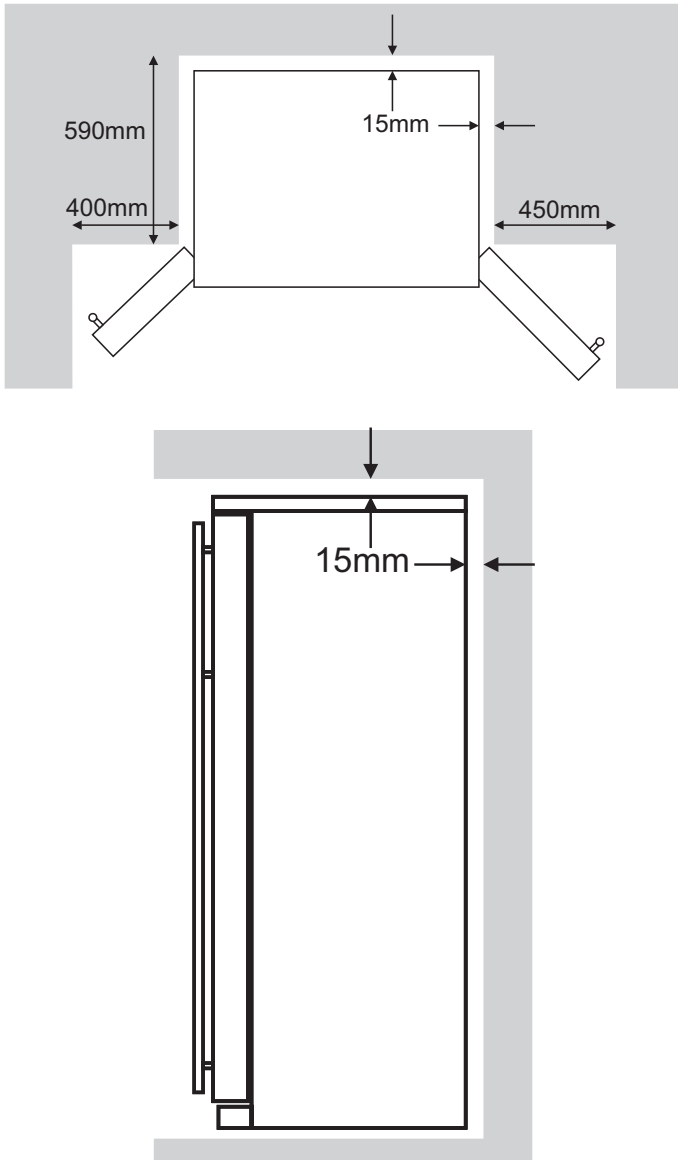

If located close to a corner adequate spacing must be left for door opening and removal of shelves. Refer to diagram.

This appliance should be 10cm at least from any electric or gas cooker and 30cm from any coal or oil stove. If this is not possible, ensure that appropriate insulation is used.

Avoid exposing the appliance to direct sunlight, and sources of heat (radiators, heaters, cookers etc.).

If this appliance is situated in a cold environment (shed, out house, garage etc.) it will affect its performance. You may find that the performance of the appliance is not consistent

and this may damage foods. Please ensure that the ambient temperature does not drop below that specified by the climate class and that temperatures are maintained as consistently as possible.

Connection to the electricity supply

Connect the appliance to the electrical supply (220 – 240V ~ 50Hz) with the plug and lead, which are fitted. Connections to the mains supply should be in accordance with local regulations.

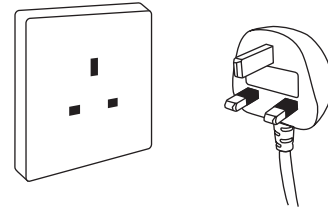

⚠ This appliance will operate within a range of 187-253V. Operation outside this range may result in damage to the control panel, thermostat or compressor, unless a regulator with a capacity of 750W, or higher, is installed.

⚠ The appliance must be plugged into an earthed socket.

- Always make sure that the plug is accessible after the appliance has been positioned.
- The refrigerator is supplied with a standard three-pin plug, of which the one for grounding should never be removed.

Care for the external cable

- Hold the plug, not the electrical cable, when unplugging the refrigerator.
- Ensure that the refrigerator does not trap the electric cable.
- Do not step on the cable.
- Avoid damage to the electric cable when moving the refrigerator.

Damaged electrical cable

When the electrical cable is damaged or worn, turn off the refrigerator and consult an authorized agent for replacement.

If inflammable gas leaks in the vicinity of the refrigerator

- Turn off any leaking valve
- Open the doors and windows

⚠ DO NOT under any circumstances unplug electrical appliances in the vicinity of the leak.

Unplug the refrigerator when:

- Cleaning or maintenance
- Replacement of the lamp.

Adjustable feet

Make sure that the appliance is on solid level flooring. If the refrigerator is placed on a plinth, flat, strong and fire resistant materials must be used.

This appliance has front adjustable feet, which can be used to level the appliance, or adjust door alignment (see below).

Door adjustment

The doors may require some alignment adjustment before you connect the appliance to the electricity supply. This can be done by making minor adjustments to the feet:

If the freezer door height is lower than the refrigerator door, use a screwdriver in the slots of the front left hand adjustable foot, turning clockwise until the freezer door height is raised in line with the fridge door. If the freezer door is lower, adjust the RH foot using the same method.

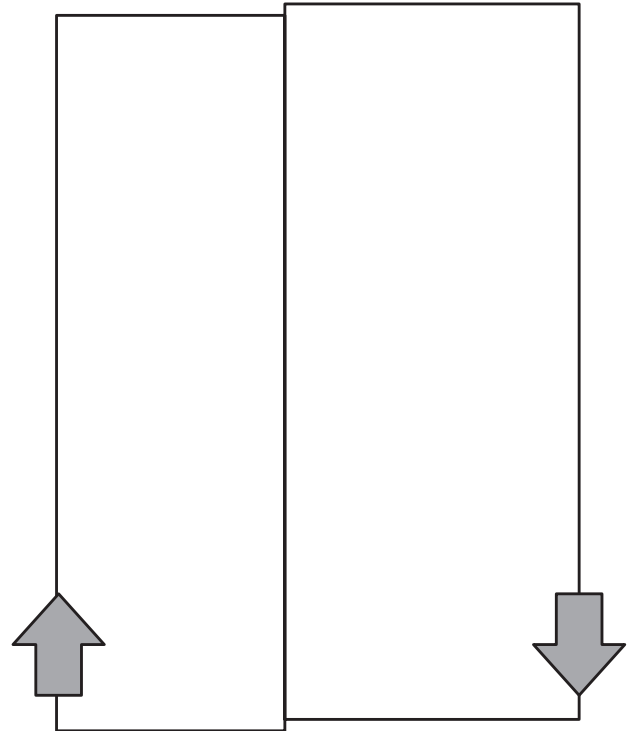
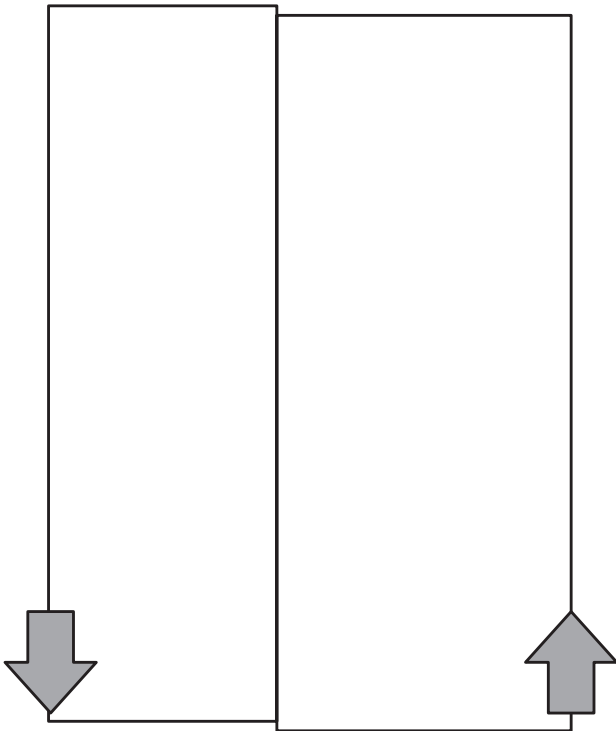
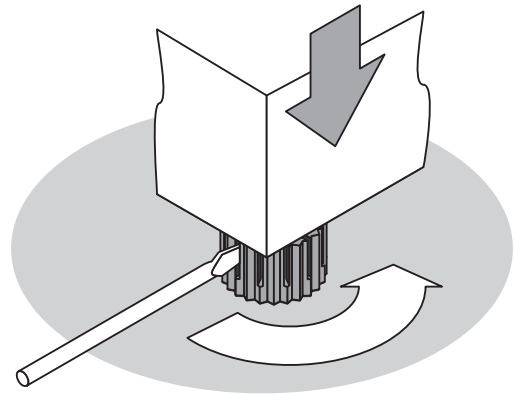
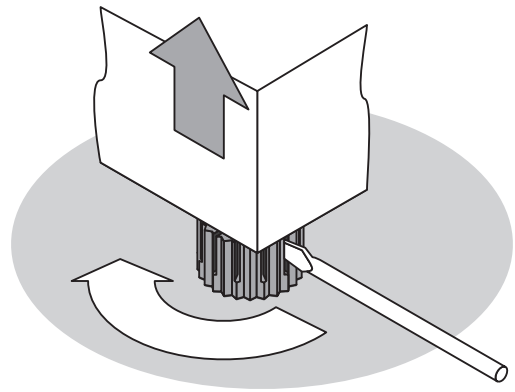

About Your Appliance

Appliance Layout

Shelves

Number of shelves supplied; 4 in the fridge, 3 in the freezer.

The shelves will not pull out accidentally when you remove foodstuff from the appliance.

Foods that are likely to perish quickly should be placed towards the rear of the appliance – where it is coolest.

Bottle holder

The bottle holder is intended for storing larger bottles (soft drinks, water etc.) inside the fridge.

Like the shelves, the bottle holder will not pull out accidentally and can be removed by holding the front edge of the holder and tapping the underside upwards, until the holder disengages from the 2 locations.

Warning: Always make sure that large bottles do not prevent the door from closing.

Dairy Compartment

Ideal for storing foods such as eggs, cheeses, butter, cartons of milk etc, separate from stronger smelling food.

Salad / vegetable drawer (Upper Crisper)

The upper drawer inside the refrigerator is used for storing fresh fruit and vegetables that require careful cooling.

Meat drawer (Lower Crisper)

The lowest drawer inside the refrigerator can be used to store fresh meat in a way, which will avoid cross contamination with other fresh foods.

The lights

The interior lights come on when the door is opened. The performance of the light is not affected by any of the appliances other settings. Should the light fail to work, it is most likely that the bulb needs replacing. (See Changing the Light bulb).

Freezer compartment

Refrigerator compartment

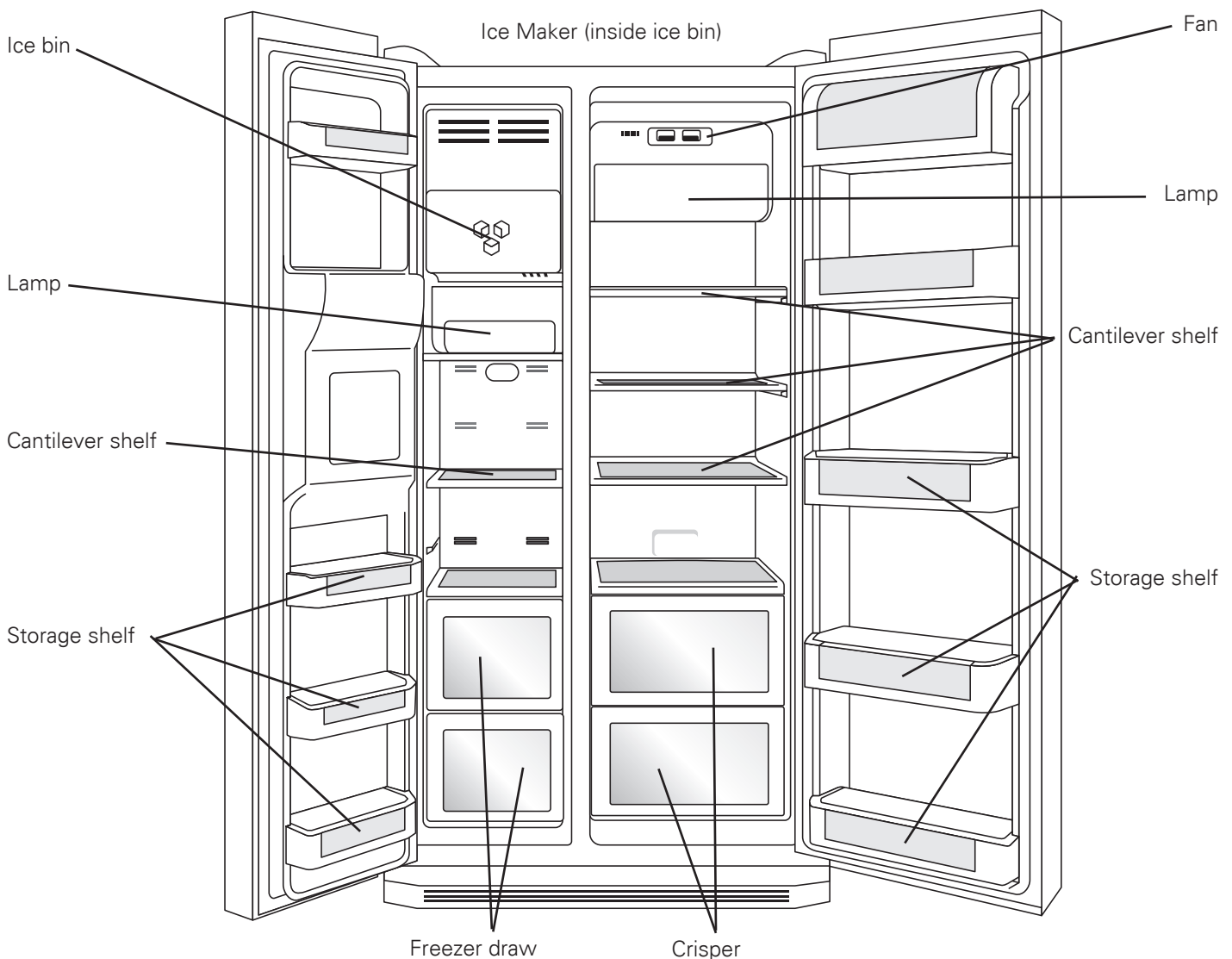

Before Using Your Appliance

Environmental Notes

Our products have been packaged using environmentally friendly materials. All packaging can be recycled. Please contact your local authority for details on recycling centres in your area.



All old electrical goods must be disposed of correctly. You should never dispose of them with household waste. Local councils / authorities can advise you as to what services they provide for the disposal of old products – please be sure that you contact them in order to dispose of all old appliances.

Many of the components in this appliance can be recycled.

Energy Saving Tips

Energy saving is especially important with cooling products.

- Check regularly that your appliance is well ventilated. Poor air circulation around the appliance can lead to inefficient operation.
- Whenever possible adjust the thermostat to reflect seasonal changes, and changes in the quantity of food stored inside.
- Freshly cooked foods, which are to be frozen, should be cooled to at least room temperature before freezing.

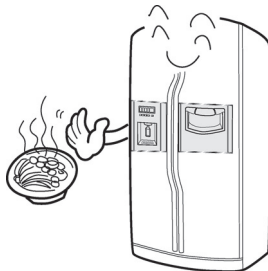

- Layers of ice and frost increase energy consumption – make sure that your appliance is free of heavy frost and ice.
- Should the door seal become dirty or damaged, please clean or replace it. A poorly working door seal is detrimental to the performance of the appliance.
- The vents at the rear of the appliance should always be clear/cleaned of dust and obstruction. Regularly checking, and cleaning if need be, should help to keep the appliance running effectively.

Ensure that the appliance is installed in accordance with the instructions given in this handbook – Failure to do so could invalidate your warranty, resulting in service charges being incurred, should you need an engineer.

Using Your Appliance

- ⚠ **Warning: Do not damage the refrigerant circuit when installing or cleaning.**
- ⚠ **Warning: Do not use any kind of mechanical device in any compartments of this appliance unless they are of the type recommended by the manufacturer.**
- ⚠ **Warning: Do not use any electrical devices to defrost this appliance unless they are a type recommended by the manufacturer.**

Once the appliance has been installed and is connected to the power supply the appliance will begin to work automatically. You can adjust the settings of the appliance to suit your requirements.

Once the temperature required inside the appliance has been reached, you should begin to load it with food. We would recommend that you do this all in one go to prevent repeated opening and closing of the door. See 'Setting and Adjusting the Temperature' for more information.

Note: The time required to reach the desired temperature will vary, depending on the setting chosen, the amount of food and the ambient temperature.

Temperature selection

Higher settings on the thermostat (towards 5) mean lower (colder) temperatures within the appliance (See guide below).

Under certain conditions (Highest setting and low ambient temperature), the temperature inside the refrigerator can drop below 0°C.

It is recommended that when the ambient temperature is normal you set the thermostat to a medium setting.

Use the highest setting only when required or recommended.

Note: Temperatures within the appliance can be affected by frequent opening of the door. Always try to keep the length of time the door is open to a minimum.

Temperature Guide

Compartment	DISPLAY	Level				
		1	2	3	4	5
FREEZER	Level	-15°C	-17°C	-18°C	20°C	-22°C
		1	2	3	4	5
FRIDGE	Level	7°C	6°C	5°C	4°C	3°C
		1	2	3	4	5

The Control Panel

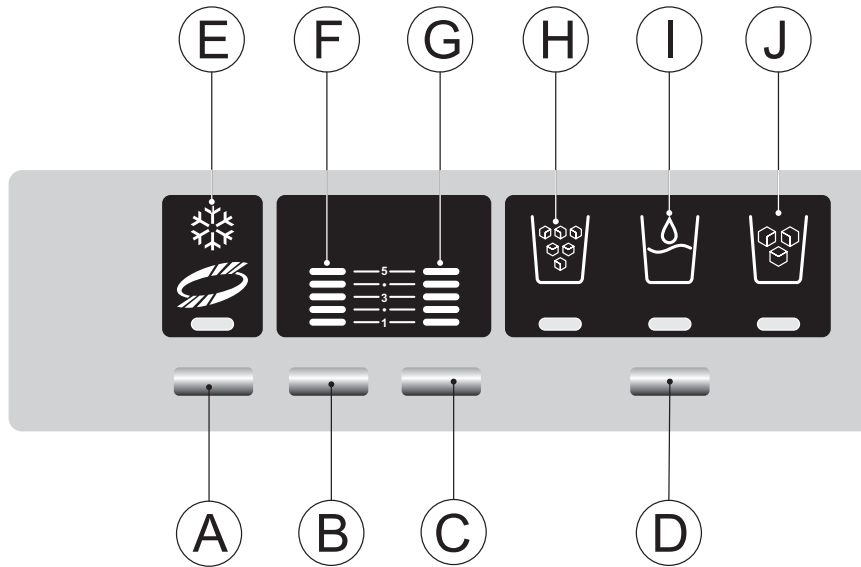

- | | | | |
|---|--------------------------|---|------------------------------------|
| A | Quick Freeze | F | Freezer temperature indicator |
| B | Freezer temperature | G | Refrigerator temperature indicator |
| C | Refrigerator temperature | H | Crushed ice selected |
| D | Ice/Water | I | Water selected |
| E | Freezer indicator | J | Cubed ice selected |

Setting and Adjusting the Temperature

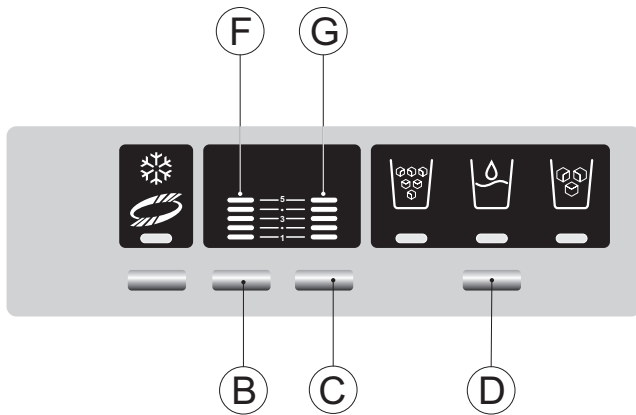

To adjust the refrigerator temperature, press button C. The indicator (G) will illuminate. Each subsequent press of button C will adjust the temperature scale by one. To clear the setting, simply keep pressing button C until indicator (G) is back to level 1.

To adjust the freezer temperature, press button B. The indicator (F) will illuminate. Each subsequent press of button B will adjust the temperature scale by one. To clear the setting, simply keep pressing button B until indicator (F) is back to level 1.

'Quick Freeze'

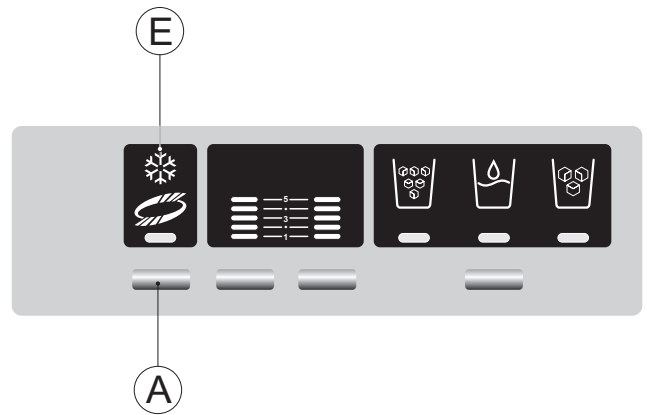

To use the 'Quick Freeze' function, press button A. Indicator E will illuminate to show you that the function is operational. To switch 'Super Freeze' off, press button A again – indicator E will go out.

Note: The quick freeze function will operate until the selected temperature level (1 to 5) has been established.

Open Door Warning

Should the door be left open for an extended period, an alarm will sound to remind you to close the door.

Control Function Display

30 minutes after the final press of any button, the display will go blank. The display will illuminate when the door is opened, or if you press any button.

Switching the refrigerator On/Off

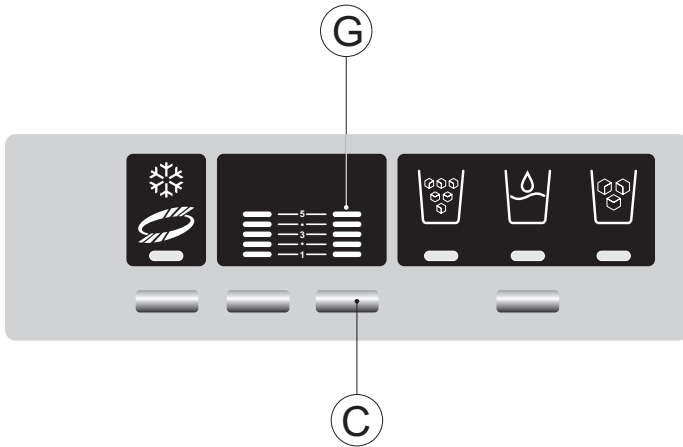

To switch off the refrigerator, press and hold button C for a few seconds. The icon (G) will disappear.

To switch the refrigerator on again, press and hold button C. Icon (G) will reappear and the appliance will begin to run as usual.

Try not to open the door too often.

Storing fresh foods

Packaging fresh foods properly, using the correct temperature and taking into account food hygiene will enhance the quality of fresh foods stored within this appliance.

Use plastic bags, aluminium foil or other food wraps to cover fresh foods not in packaging to prevent flavour transfer and prevent contamination.

Make sure that foods, which have been cooked and require chilling, are at room temperature before placing them into the appliance. Make sure that these foods are stored in suitable containers.

Before storing items in multi packs (i.e. yoghurt) remove any excess packaging.

Make sure that foodstuffs are stored systematically (raw meats with raw meats, dairy with dairy) to avoid flavour transfer and cross contamination. Raw meats should be stored towards the bottom of the appliance to prevent the possibility of it dripping onto uncooked food. Other foods should be stored above raw meat.

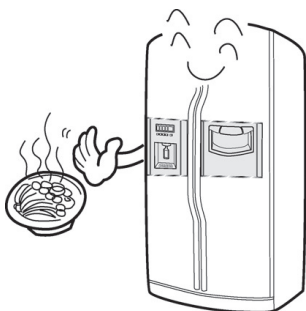

! Never store anything, which is flammable, volatile or explosive inside the appliance.

Beverages with high alcohol content should be stored vertically in tightly sealed bottles.

Foods should not touch the rear wall of the appliance.

Delicate foods should be stored in the coolest part of the appliance.

Try not to open the door too often.

Set the thermostat to make sure that foods remain suitably cold, try to avoid freezing within the fridge. Using a thermometer will help you to judge how cool the appliance is. Place it into a glass of water and leave it inside the appliance for several hours to get a reliable reading.

Some foods contain natural oils and acids (e.g. citric acid) which can damage plastics if spilled – make sure these foods are suitably contained.

Unpleasant odours inside the fridge are a sign that something has spilled and cleaning is required. Using warm water with bicarbonate of soda will clean the interior of the appliance and remove most spillages. (See cleaning your appliance).

Always remember to remove perishable foods from this appliance before taking prolonged trips of holidays.

Freezing fresh foods

As with storing fresh foods, suitable packaging, correct temperature and food hygiene will enhance the quality of the food you are freezing.

Make sure that all foods for freezing are of a high quality, and suitable for freezing.

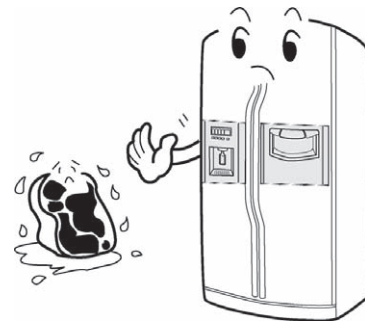

Use suitable packaging (plastic bags etc.) to store food in, and make sure that it is air tight or well sealed. Leaking packaging will dehydrate the products and lead to loss of beneficial vitamins.

Mark packages with the kind of food contained and the date of storage.

Food needs to be frozen quickly, so it is best to freeze small portions whenever possible and ensure that they are as cold as possible before storage. The recommended maximum weight for each portion is 2.5kg.

Keep food which is fresh away from food which is already frozen, if you need to freeze fresh food every day, make sure that it is in small portions to prevent this.

Do not exceed the maximum load for freezing – which is given as 10kg / 24H - see data badge for details.

Freezing procedure

This appliance is fitted with a 'Quick Freeze' function. This function is ideal if you are freezing large quantities of foods as it freezes quickly helping to preserve freshness and maintain the level of nutrients in foods which can be lost through freezing.

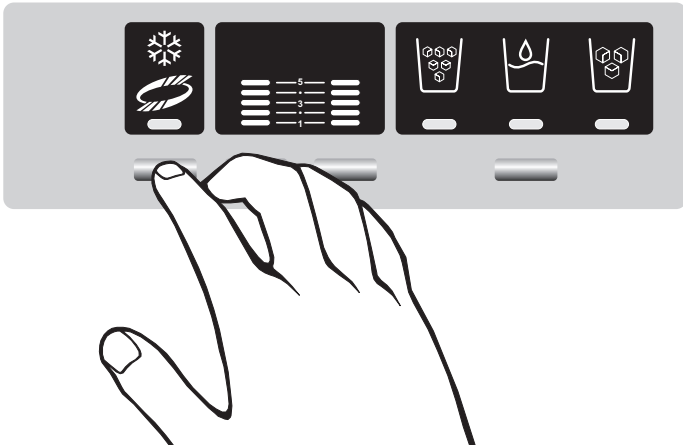

It is also advisable to use this function before you clean the appliance interior to ensure that foods are as frozen as possible.

Storing frozen foods

When storing commercially frozen foods, please follow these guidelines.

⚠ Always follow manufacturers' guidelines for the length of time you should store food for. Do not exceed these guidelines!

- Try to keep the length of time between purchase and storage as short as possible to preserve food quality.
- Buy frozen foods, which have been stored at a temperature of -18°C or below.
- Avoid buying food which has ice or frost on the packaging – This indicates that the products might have been partially defrosted and re-frozen at some point – Temperature rises affect the quality of food.
- When consuming ice cream or water ices allow them to warm a little first to prevent freezer burns on hands or tongue.
- Should there be a power cut, or the freezer / refrigeration appliance fail for any length of time you may need to remove food from the freezer and store in a cold, hygienic place (i.e. garage or out house area) until the power is restored, or the appliance is repaired.



To prevent undue temperature rises; you should wrap the foods in layers of insulating material, such as newspaper, to help to maintain their temperature. It is also important that any food affected by this situation should be either consumed or cooked and re-frozen (where suitable) soon afterwards in order to prevent health risks.

Layers of newspaper can also be used to help keep foods cold while you are defrosting the freezer (see cleaning your appliance).

Storage areas

About your Freezer Compartment

As with the refrigerator, certain areas of the freezer are better for storage of certain foods.

Ice creams and water ices are best stored towards the rear of the appliance where it is coldest.

Large / heavier portions of food, such as meats joints for roasting are best stored in the drawers at the bottom of the appliance, while less weighty items should be stored on the shelves – this is to prevent damage to the appliance.

You should always make sure that food stored is suitable for freezing, and that you have stored it securely inside the appliance.

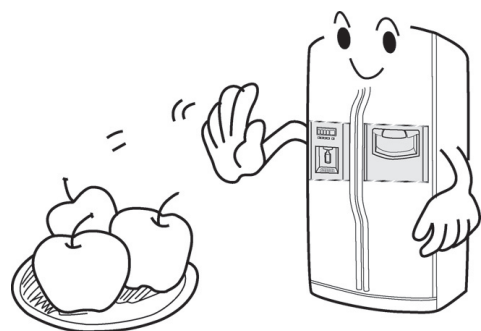

Defrosting food for cooking

Should food become partially thawed, or defrosted it should be consumed as soon as possible as the quality will be affected by defrosting.

⚠ Always make sure that food is thoroughly defrosted before cooking and no ice crystals remain. This is especially important for poultry, as this can be extremely harmful to health.

Always follow the defrosting instructions on packaging when defrosting ready meals – manufacturers' guidelines are always best, as some frozen foods should be cooked from frozen.

About your Refrigeration Compartment

Temperature differences exist inside the refrigerator so it is sensible to store different foods in different areas of the appliance.

1. Eggs, butter and cheeses. (Dairy compartment with cover)
2. Smaller bottles, cans, jars, packages.
3. Large bottles, soft drinks, water, wine etc.
4. Any fresh produce – store carefully to avoid cross contamination.
5. Salad / vegetable drawer
6. Fresh, uncooked meats – store carefully to avoid cross contamination and spillages.

Crisper compartment

To keep fruit and vegetables crisp and fresh, this appliance has a crisper compartment with adjustable humidity.

High humidity will keep foods such as grapes, cucumbers, kiwi etc. fresh and crisp - this is achieved by opening fewer holes in the moisture control.

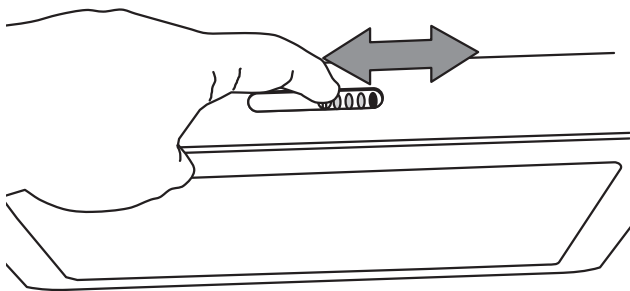

Lower humidity is ideal for storing foods such as strawberries, melons, tomatoes and beans. Opening more holes in the moisture control will lower the humidity accordingly.

Always make sure that the front edge of the crisper compartment is underneath the crisper cover. When removing the crisper, remove the compartment first before the cover.

To remove the cover of the crisper (for cleaning etc.) remove

the drawer first. Lift the food shelf in an upward direction at the rear (1) and pull it towards you (2). Then turn the shelf into position (3). You must have the appliance door open by 90°.

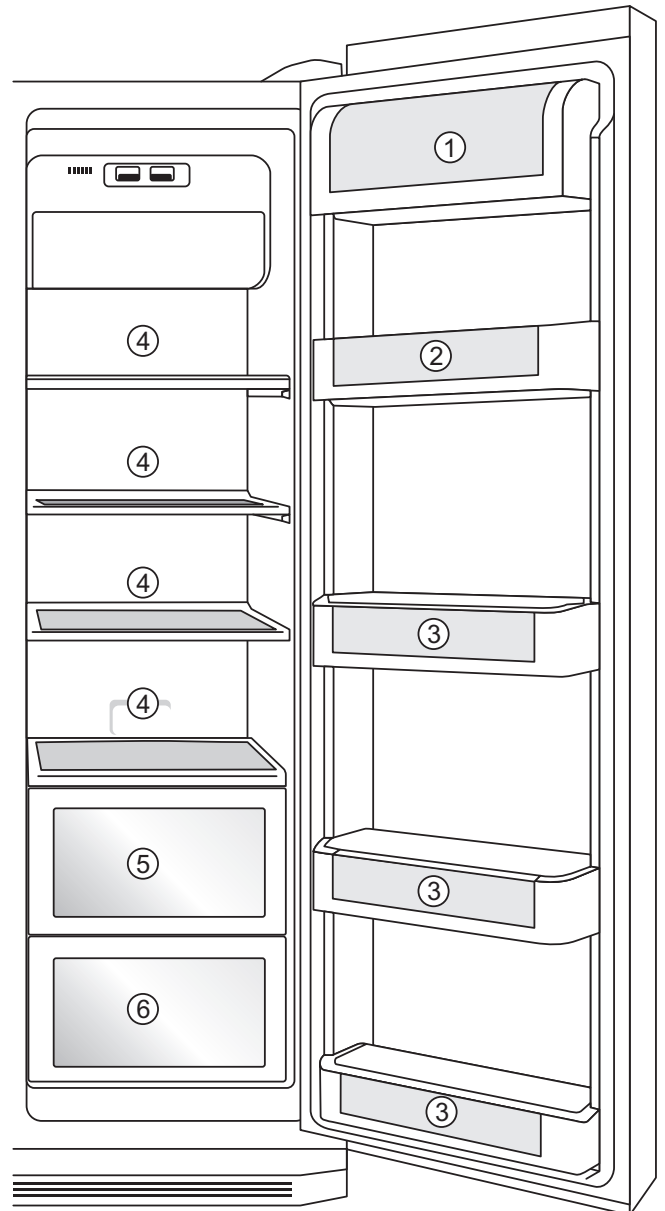

Using the Icemaker & Water Dispenser

Before using the Icemaker/Water Dispenser

Water supply installation

Pressure of the cold water supplied to the automatic icemaker is between 1.5 - 8.5Bar.

Installation instructions for the connection kit (to a potable/drinking water supply) are found inside the fridge.

Caution: Only an authorised person should install the water pipes and filter.

- The water tube should be of an appropriate length - usually 12 metres - and should be free of bends after being inserted into place. If the tube is too long then pressure will be reduced, therefore reducing the capacity of ice making.
- Always use potable / drinking water.
- Keep the water tube clear of heat sources.
- The water tube should be installed and tested by authorised personnel.
- When used for the first time, press and hold the cold-water button for one minute to prime the water supply. Do not press the cold-water button for any longer as this may cause the valve to heat up.

Precautions

- Never expose the water pipe to temperatures below 0°C to avoid freezing.
- Test the tubing for leaks by flushing the tube through with water, until the water runs clear.
- After the appliance has been sited into the location of your choice, make sure that the water tube is arranged so it does not incur damage through bends and kinks and is clear of any heat sources.
- A qualified appliance installer must install this appliance.
- Once the temperature inside the freezer is at -15°C ice production will begin.
- Do not over use the icemaker. If you attempt to use the ice cube button too often it will go into a shut down mode. This is perfectly normal and requires you to wait for one hour before attempting to re-use it.
- Do not use delicate or fragile glassware.
- Do not touch the ice cube outlet with your hands, or any implements to avoid injury or damage.

How the icemaker works

In every cycle 8 ice cubes are produced.

Capacity of the icemaker depends on the freezer temperature, the ambient temperature of the environment around the appliance and how often the freezer door is opened.

Do not store ice cubes, which are produced during the first batch of cubes following appliance start up, or after a prolonged break. Discard these cubes.

To ensure that the ice cube tray is filled to maximum capacity, you will need to manually arrange the ice cubes periodically.

Some ice cubes may stick together when dropped into the storage box – you will need to separate these to ensure maximum use of the icebox.

First use of the icemaker / water dispenser

Do not consume the first seven (approx) glasses of water, as there may be dust and / or impurities within the water pipes.

This will ensure that the pipes are cleared.

If in doubt, keep re-using the dispenser until the water runs clear.

Noises during ice making

The ice making process can be noisy. You may hear ice being dropped into the storage compartment. This is perfectly normal.

Storing ice for extended periods

Ice, which is stored for a long period of time, may go an opaque colour and have a strange odour. We recommend that you dispose of this ice, remove and clean the icebox. Allow the tray to dry thoroughly and cool down before replacing into the appliance to prevent ice from sticking.

Preventing ice from being made

If you do not require any ice over a prolonged period of time (i.e. during winter) you can switch off the valve between the water supply and the appliance. It is recommended that you clean the icebox, dry it carefully and replace it back into the appliance – this will prevent any odours being produced.

Installation/Removal of the ice cube storage tray

To remove the icebox, press the top of the drawer and simultaneously pull the bottom, releasing the unit.

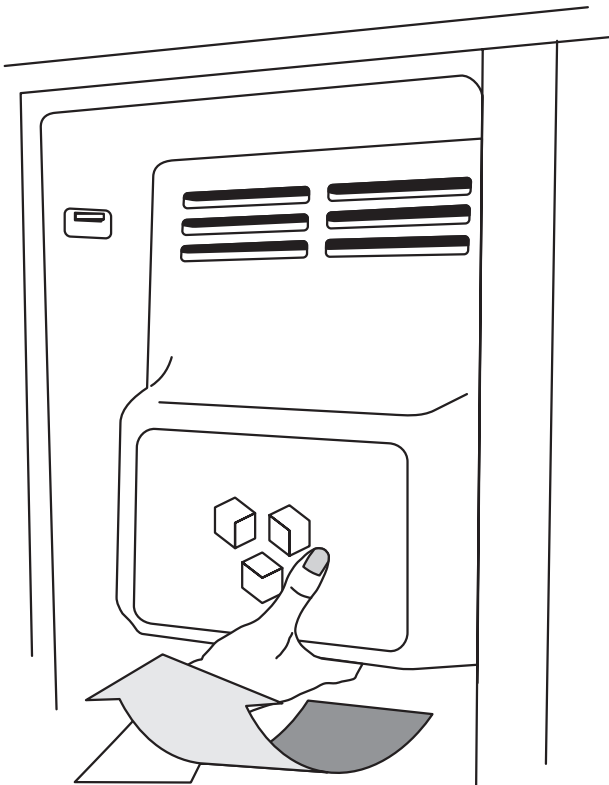

If the icebox cannot be easily fitted, remove it and turn the corkscrew mechanism 90°. Then reinstall the icebox, ensuring that the catch pin on the tray fits into the slot on the shelf.

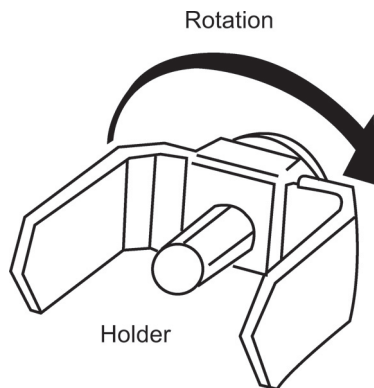

If the ice maker does not work properly

The volume of the icebox equals the quantity of ice cubes, which the appliance can make in one day. Occasionally small number of ice cubes may remain inside the box. If the ice gets stuck, this will result in abnormal operation of the ice cube maker. To avoid this problem, remove the icebox and rearrange the ice cubes, and remove ice cubes, which cannot be separated.

⚠ Always keep the ice cube outlet clean and clear of obstructions.

Using the Icemaker & water dispenser

There are three options available with this accessory – crushed ice, cool water or ice cubes. Always make sure that you hold your glass up to the dispenser before making your selection to avoid spillages.

Crushed ice supply

1. Hold the glass to the dispenser.

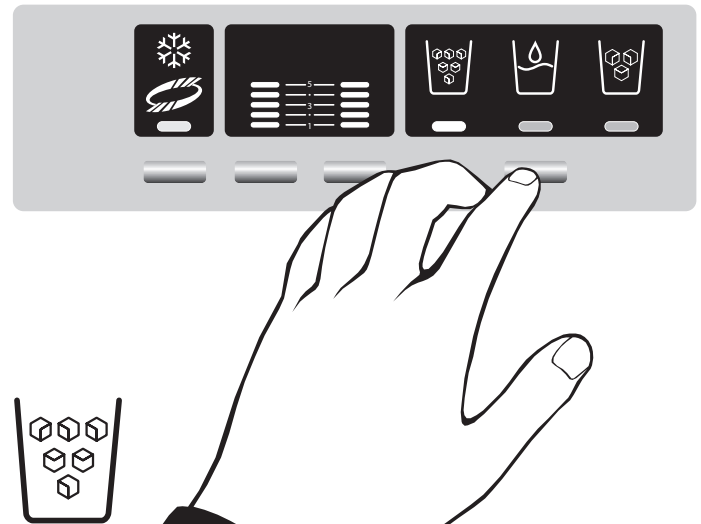

2. Press the button for crushed ice.
3. Slightly push the glass onto the lever switch and the crushed ice will be dispensed into the glass.

Ice cubes

1. Hold the glass to the dispenser.

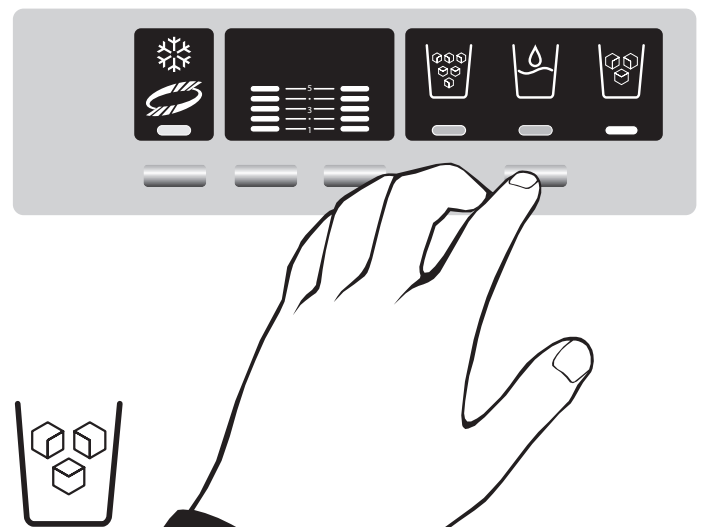

2. Press the button for ice cubes.
3. Slightly push the glass onto the lever switch and the ice cubes will be dispensed into the glass.

Cool water supply

1. Hold the glass to the dispenser.

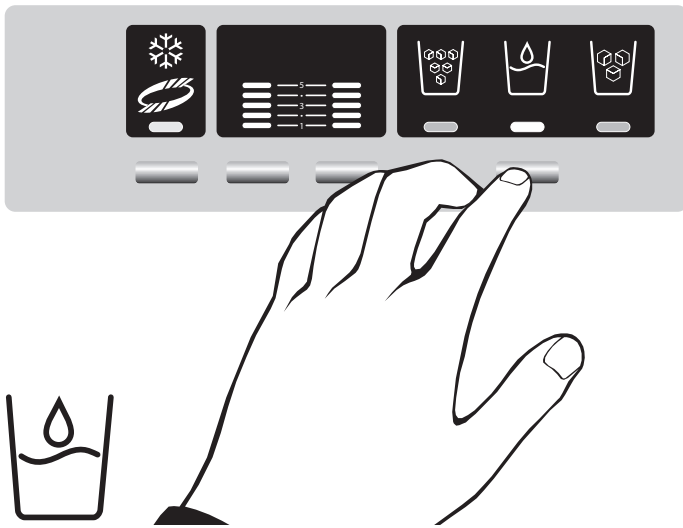

2. Press the button for cool water.
3. Slightly push the glass onto the lever switch and the cool water will be supplied.

Notes:

When crushed ice is supplied;

Some times you may receive crushed ice when you have selected ice cubes as there may be crushed ice remaining in the crushing mechanism. This is normal. Try again until you receive ice cubes.

If crushed ice is supplied frequently, you may notice a build up of ice around the front of the icebox. This will defrost automatically and is not a problem.

When cool water is supplied;

Following installation, cool water may not be available immediately. This is due to air in the pipes. Press the cool water supply button until water is dispensed to clear the air. This can take up to two minutes.

The water supply will become cooler and cooler gradually.

Cool water does not contain ice – this should be added before the water.

Safety

⚠ Do not use excessively deep, narrow, fragile or delicate glasses.

- Hold the glass as close as possible to dispenser to avoid spilling water, dropping ice or blockages in the ice cube dispenser.
- Five seconds after the final delivery of ice or water, the dispenser flap will close with a 'phutt' sound. Hold the glass still for a further 2 – 3 seconds (for ice), 1 - 2 seconds (for water) after you have filled your glass and released the lever switch as additional water or ice may be produced.

- Regularly clean the dispenser.
- Crushed ice may be dispensed instead of cubed ice if crushed ice was the last option selected.

⚠ Never place canned drinks or foods inside the dispenser, as this will damage the crushing mechanism.

⚠ Do not touch the dispenser, or remove the icemaker cover to prevent accidental injury or damage to the appliance.

- First supply of water (seven glass approx) and ice cubes (20 pieces approx) should not be consumed after initial start up or following a lengthy break in use. Dispose of these accordingly.
- Do not place ice cubes, which have not been produced by the icemaker into the storage drawer to prevent damage to the mechanism.
- Insufficient water supply may lead to small ice cubes. Excessive water supply may lead to larger cubes, which may stick together, cause leaks and block the dispenser. You should adjust the faucet or contact a service engineer.

Automatic defrosting

There is no need to defrost the refrigerator as this appliance has automatic defrost.

⚠ Do not use mechanical devices to accelerate the defrosting process – unless they are of a type recommended by the manufacturer.

In the event of a power cut

Should there be a prolonged power cut you may need to remove food from the freezer compartment and store it in a cold place, wrapped in layers of newspaper to preserve suitable temperatures.

In the event of a power cut, food should remain safely cold for 3 hours approx.

Once power is restored – replace the food back into the freezer compartment.

Should food begin to defrost, or the power cut last longer than expected, it is advised that you consume any food removed from the freezer.

If the power outage is short term, most foods can be left inside the freezer compartment – this is the best way of preserving temperature – and surrounded by ice cubes from the icebox. This is also an ideal solution for power outages you may have been pre warned about.

When experiencing a power cut of any kind, do not add any extra foods to the freezer.

Maintenance and Cleaning

Cleaning the inside of your appliance

- Always disconnect the electricity supply before you start cleaning.
- Empty the appliance of food and remove the shelves.
- The interior can be cleaned using warm water and bicarbonate of soda, with a soft cloth. Make sure that the interior is then dried carefully with a suitable cloth.

! Do not use harsh abrasives, or aggressive cleaners as these can damage the interior of the appliance.

- Shelves and other accessories (plastic and glass parts) can be cleaned in the sink using liquid dish washing liquid and warm water. Make sure all soap is rinsed off and all parts are dry before replacing them inside the appliance.
- Always keep the door seals clean.

Removing the shelves/Salad/vegetable crisper cover

- Lift the food shelf in an upward direction at the rear (1) and pull it towards you (2). Then turn the shelf into position (3). You must have the appliance door open by at least 90°.

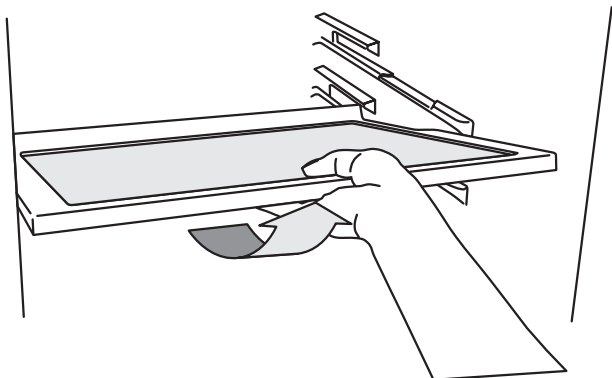

- To remove the crisper cover, remove the crisper drawer first and then follow the above directions.

! Do not wash plastic parts in a dishwasher.

Clean the exterior of the appliance with a soft cloth and an alcohol based cleaner. Do not use abrasive cleaners on the exterior of the appliance.

The vents at the rear of the appliance should be cleaned periodically using a soft bristled brush or the brush attachment of a vacuum cleaner.

Once cleaning is completed, reconnect the electricity supply and replace the food.

When not in use

If you are not using the appliance for an extended length of time, it is recommended that you switch off the electrical supply, empty any food out, clean the inside of the appliance and leave the door ajar. This will save energy, and also prevent a build up of stale odours inside.



Changing the plug (UK)

This appliance comes fitted with a 13amp plug fitted. Should you need to replace the fuse, a 13amp ASTA approved (BS 1362) must be used. Should the plug itself need to be replaced, the wires in the mains lead are coloured in accordance with the following code:

Green and yellow = Earth

Blue = Neutral

Brown = Live

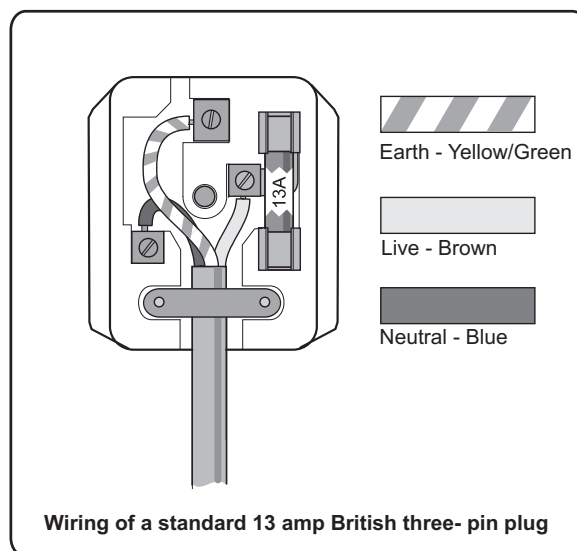

The wire coloured green and yellow must be connected to terminal marked with the letter E, coloured green and yellow or marked with the earth symbol:

The wire coloured blue must be connected to the terminal marked with the letter N, or coloured blue.

The wire coloured brown must be connected to the terminal marked with the letter L or coloured brown.

Upon completion, there must be no cut or stray wire present and the cord clamp must be secure over the outer sheath.

Changing the light bulb

Before replacing the light bulb, switch off the electricity supply to the appliance and unplug the appliance.

Lamp required: 220 – 240V~25W (fridge only)

Lamp required: 220 – 240V~40W (freezer only)

⚠ Lamp holder: E27 (Do not exceed the wattage given for lamps)

To replace the lamp;

1. Pull the lampshade towards you.
2. Hold up (1) and pull out (2) the lampshade.
3. Rotate the lamp anticlockwise until the lamp is released.
4. Always replace the bulb with one that is identical.

Bulbs are not covered by any warranty, but can be purchased at your local hardware store. Remember to take the old bulb with you if you are unsure of what kind of bulb to buy.

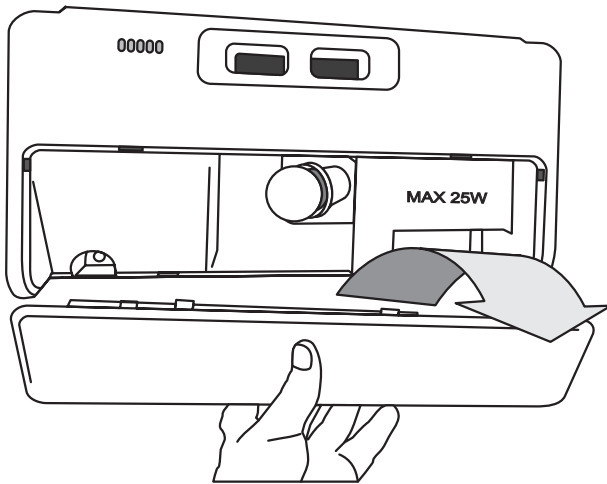

Troubleshooting

The appliance fails to work when first connected to the electricity supply.

Check there are no faults with the socket you are using by plugging in an appliance you know to be working.

Make sure that you have switched the appliance 'on'.

The voltage may be incorrect.

The appliance seems to be continually running.

The appliance will make a sound when first started; this will gradually fade over a period of time.

The door has been opened frequently.

The door isn't properly closed because the seals need cleaning, or are damaged.

The door is damaged – leading to it dropping out of correct alignment with the appliance.

The appliance has recently been filled with more food than usual.

Ventilation is compromised – the vent requires cleaning or clearing from obstruction.

There is inadequate ventilation around the appliance – other appliances or units are too close. The appliance has been overloaded with food for chilling or freezing.

The 'Quick Freeze' function has been switched on.

The outer casing of the appliance is warm

The appliance may become warm on the outside when first switched on to prevent condensation forming.

The lamp does not work

The appliance is not plugged into the wall socket / a fuse has blown.

The bulb requires replacing.

The temperature inside the appliance is not right

The door has not been closed properly.

The appliance is too close to a heat source, or in direct sunlight.

The vents at the rear are blocked / obstructed.

The appliance is making noises

The appliance is cooled by the compressor, which will make a certain amount of noise when the appliance is switched on. The amount of noise depends on the age of the appliance (older appliances may become noisier), the positioning of the appliance (a levelled appliance is less noisy) and how the appliance is used.

During use, you may hear the sound of the refrigerant being circulated, and the sound of it flowing when the compressor is off. The sound of the compressor itself, which is a humming sound and a click when the compressor switches off and on.

When you are starting the appliance for the first time, or have had the appliance switched off for a prolonged length of time, the sounds described above may be louder.

You may hear hissing or gurgling noises from the appliance – these are due to the automatic defrosting process.

Piping and the evaporator may also make noises should the ambient temperature around the appliance change.

If noises seem to be too loud, or a little unusual it is more than likely because the appliance requires levelling, or it is touching a unit.

Warranty/After Sales Service

If consultation or technical assistance is needed, please provide the local authorised service agent with the purchase invoice and the product code/serial number, which is located inside the refrigerator – Top left hand side.

The 2 year free maintenance for the operation of the appliance started from the date of purchase of this product.

Any cosmetic damage to the appliance must be reported within 90 days of delivery.

For in-warranty service please call 0845 6035312.

For general enquiries please call 0870 7895107.

RANGEmaster

Clarence Street, Royal Leamington Spa,
Warwickshire, CV31 2AD, England.
Tel: +44 (0) 1926 457400 Fax: +44 (0) 1926 450526
E-mail: consumers@rangemaster.co.uk
www.rangemaster.co.uk

AGA Consumer Products

Free Manuals Download Website

<http://myh66.com>

<http://usermanuals.us>

<http://www.somanuals.com>

<http://www.4manuals.cc>

<http://www.manual-lib.com>

<http://www.404manual.com>

<http://www.luxmanual.com>

<http://aubethermostatmanual.com>

Golf course search by state

<http://golfingnear.com>

Email search by domain

<http://emailbydomain.com>

Auto manuals search

<http://auto.somanuals.com>

TV manuals search

<http://tv.somanuals.com>