

**RC60**  
**Ceramic Hob**  
**RC60SS**  
**Ceramic Hob**

**User Guide**

&

Installation & Service Instructions



U109915 - 02

## **Contents**

---

Before You Start...	1
Hob Overview	3
Cleaning Your Hob	8
Troubleshooting	9
Installation	10
Circuit Diagram	13
Technical Data	14
Warranty/After Sales Service	15

# 1. Before You Start...

---

Thank you for buying a Rangemaster hob. It should give you many years trouble-free cooking if installed and operated correctly. It is important that you read this section before you start, particularly if you have not used a ceramic hob before.

**⚠ This appliance is designed for domestic cooking only. Using it for any other purpose could invalidate any warranty or liability claim. In particular, the oven should NOT be used for heating the kitchen – besides invalidating claims; this wastes fuel and may overheat the control knobs.**

## Installation and Maintenance

In the UK, the electrical installation should be in accordance with BS 7671. Otherwise, all installations must be in accordance with the relevant instructions in this booklet, with the relevant national and local regulations, and with the local electricity supply companies' requirements.

Make sure that the hob is wired in and switched on.

Only a qualified service engineer should service the hob and only approved spare parts should be used.

Always allow the hob to cool and then switch it off at the mains before cleaning or carrying out any maintenance work, unless specified otherwise in this guide.

## Ventilation

Using a cooking appliance will result in the production of heat and moisture in the room in which it is installed. Make that the kitchen is well ventilated; keep natural ventilation holes open or install a powered cooker hood that vents outside. If you have several cooking zones on or use the hob for a long time, open a window or turn on an extractor fan.

## Personal Safety

**⚠ Accessible parts will become hot during use and will retain heat even after you have stopped cooking. Keep babies and children away from the hob and never wear loose-fitting or hanging clothes while the appliance is in use.**

**⚠ When not in use make sure that the hob is switched OFF.**

**⚠ Always keep combustible materials, e.g. curtains, and flammable liquids a safe distance away from your hob.**

**⚠ Do not spray aerosols in the vicinity of the hob while it is on.**

**⚠ Use dry oven gloves when applicable – using damp gloves might result in steam burns when you touch a hot surface. Do not use a towel or other bulky cloth in place of a glove – it might catch fire if brought into contact with a hot surface.**

**⚠ Never operate the hob with wet hands.**

**⚠ Never heat unopened food containers. Pressure build up may make the containers burst and cause injury.**

**⚠ Do not use unstable saucepans. Always ensure that you position the handles away from the edge of the hotplate.**

Never leave the hotplate unattended at high heat settings. Pans boiling over can cause smoking, and greasy spills may catch on fire. Use a deep fat thermometer whenever possible to prevent fat overheating beyond the smoking point.

**⚠ Never leave a chip pan unattended. Always heat fat slowly, and watch as it heats. Deep fry pans should be only one third full of fat. Filling the pan too full of fat can cause spill over when food is added. If you use a combination of oils or fats in frying, stir them together before heating, or as the fats melt.**

Foods for frying should be as dry as possible. Frost on frozen foods or moisture on fresh foods can cause hot fat to bubble up and over the sides of the pan. Carefully watch for spills or overheating of foods when frying at high or medium high temperatures. Never try to move a pan of hot fat, especially a deep fat fryer. Wait until the fat is cool.

**⚠ Do not use water on grease fires and never pick up a flaming pan. Turn off the controls and then smother a flaming pan on a surface unit by covering the pan completely with a well fitting lid or baking tray. If available, use a multipurpose dry chemical or foam-type fire extinguisher.**

Take care that no water seeps into the appliance.

## Hob Care

**Never** cook directly on the hob surface.

**Do not** use the hob surface as a cutting board.

**Do not** leave utensils, foodstuffs or combustible items on the hob when it is not in use (e.g. tea towels, frying pans containing oil).

**Do not** place plastic or aluminium foil, or plastic containers, on the hob.

**Do not** leave the hob zones switched on unless being used for cooking.

**Never** allow anyone to climb or stand on the hob.

**Do not** stand or rest heavy objects on the hob. Although the ceramic surface is very strong, a sharp blow or sharp falling object (e.g. a salt cellar) might cause the surface to crack or break.

Should a crack appear in the surface, disconnect the appliance immediately from the supply and arrange for its repair.

Always LIFT pans off the hob. Sliding pans may cause marks and scratches. Always turn the control to the OFF position before removing a pan.

**Do not** place anything between the base of the pan and the hob surface (e.g. asbestos mats, aluminium foil, Wok stand).

Care should be taken that no water seeps into the appliance.

Avoid heating an empty pan. Doing so may damage both the hob and pan.

**Do not** use abrasive cleaners/pads, oven aerosols/pads or stain removers on the surface.

We recommend that you avoid wiping any surface unit areas until they have cooled and the residual heat indicator has gone out. Sugar spills are the exception to this (see '*Cleaning your Hob*'). After cleaning, use a dry cloth or paper towel to remove any cleaning cream residue.

## Cleaning

The ceramic surface should be washed after use in order to prevent it from becoming scratched or dirty.

In the interests of hygiene and safety, the hob should be kept clean at all times as a build up in fats and other foodstuffs could result in a fire.

Clean only the parts listed in this guide.

Clean with caution. If a wet sponge or cloth is used to wipe spills on a hot surface, be careful to avoid steam burns. Some cleansers can produce noxious fumes if applied to a hot surface.

## 2. Hob Overview

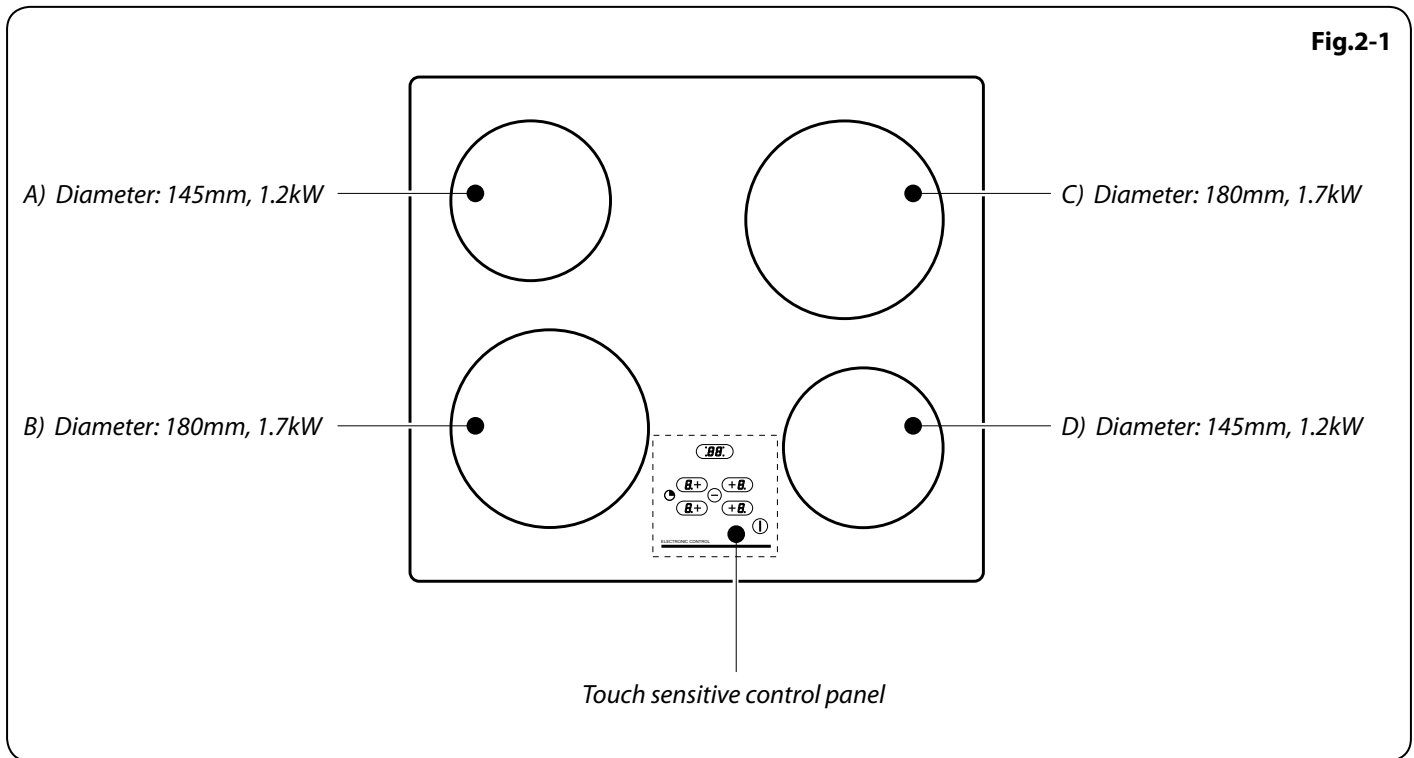

The ceramic hob comprises of four cooking zones containing heating elements with different ratings and diameters (**Fig.2-1**), each with a residual heat indicator. Each zone is controlled via the touch sensitive controls with an audible signal when operated.

### The Hob

Use only pans that are suitable for ceramic hobs. We recommend stainless steel and enamelled steel pans as pots and pans with copper or aluminium bases leave traces on the hob that are difficult to remove. Glass-ceramic cookware is not suitable because of its poor conductivity. *The kind of pan you use and the quantity of food affects the setting required. Higher settings are required for larger quantities of food.*

Pots and pans should have thick, smooth, flat bottoms (**Fig.2-2**). This ensures the maximum heat transfer from the hob to the pan, making cooking quick and energy efficient. Never use a round-bottomed wok, even with a stand.

The very best pans have bases that are very slightly curved up when cold (**Fig.2-3**). If you hold a ruler across the bottom you will see a small gap in the middle. When they heat up the metal expands and lies flat on the cooking surface.

Make sure that the base of the pan is clean and dry to prevent any residue burning onto the hob panel. This also helps prevent scratches and deposits.

Always use pans that are the same size as (or slightly larger than) the areas marked on the hob top (**Fig.2-4**). Using smaller pans wastes heat, and any spillage will be burnt on. Using a lid will help the contents boil more quickly.

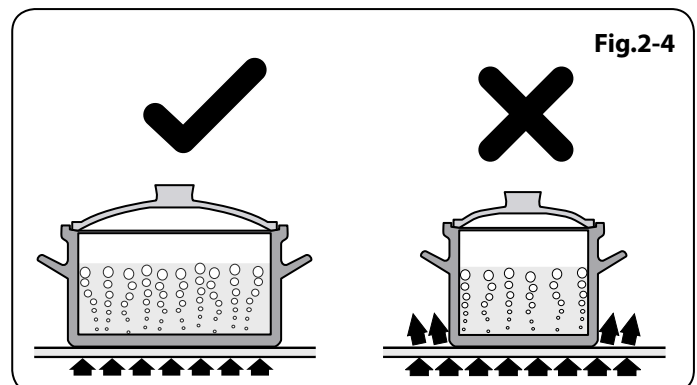
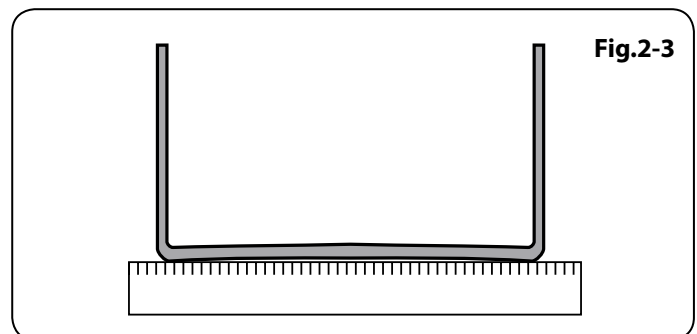
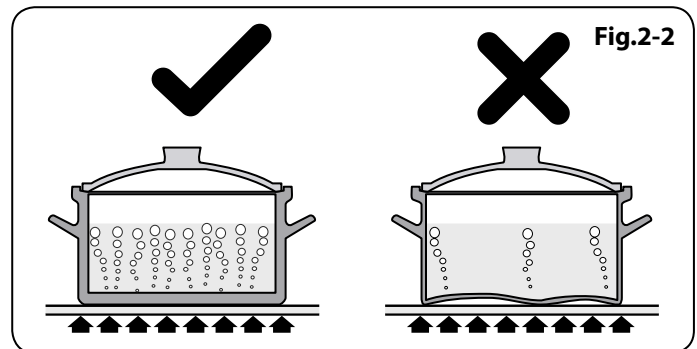
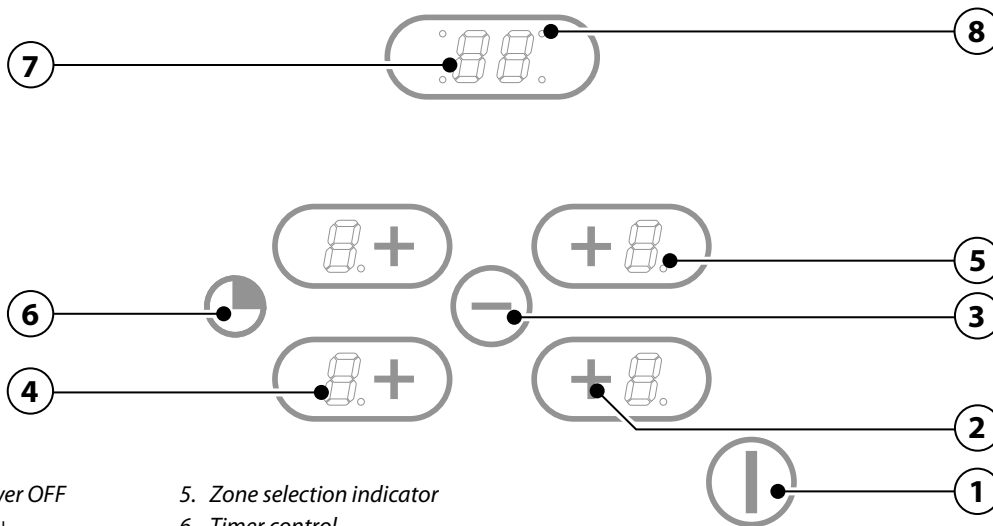

Fig.2-5



- 1. Power ON/Power OFF
- 2. Cooking zone +
- 3. Cooking zone -
- 4. Digital display
- 5. Zone selection indicator
- 6. Timer control
- 7. Timer display
- 8. Timer indicator lights (4 off)

**⚠ Always take care before touching the surface, even when the hob is turned off. It may be hotter than you think!**

### Residual Heat Indicator, 'H'

After use, a cooking zone will remain hot for a while as heat dissipates. When a hot cooking zone is switched off the residual heat indicator symbol, 'H', will appear in the display. This shows that the cooking zone temperature is above 60°C and may still cause burns. Once the temperature has dropped to below 60°C the 'H' will go out.

### The Control Panel

The control panel consists of touch controls to operate the 4 cooking zones, the timer and child lock features (Fig.2-5).

### Operating The Hob

To switch on the hob press the On/Off key for about 2 seconds. Each of the cooking zone digital displays will illuminate, showing '0' and a flashing dot (Fig.2-6).

**Note:** If further hob functions are not activated within 20 seconds it will automatically shut down.

#### To activate a cooking zone:

Select the required cooking zone by pressing the '+' on the appropriate control. A red 'dot' will illuminate on the selected display to indicate that the zone has been selected. Note that only one cooking zone can be selected at any one time.

To increase the power level, press the '+' key, up to a maximum of '9' (Fig.2-7).

**Note:** The '+' keys have a repeat function: holding the key pressed down will increase the power setting by one level every 0.3 seconds.

Fig.2-6

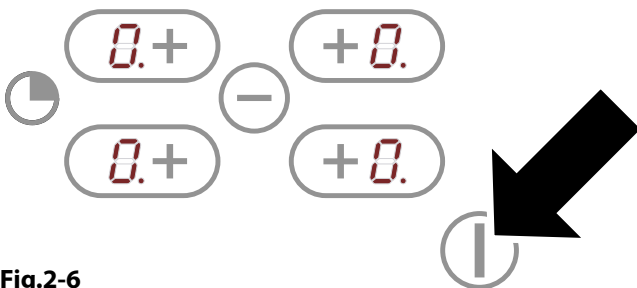

Fig.2-7

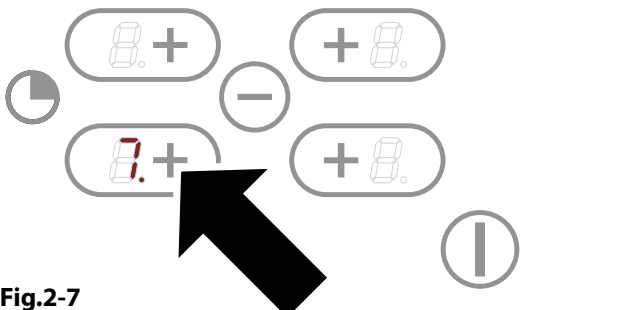
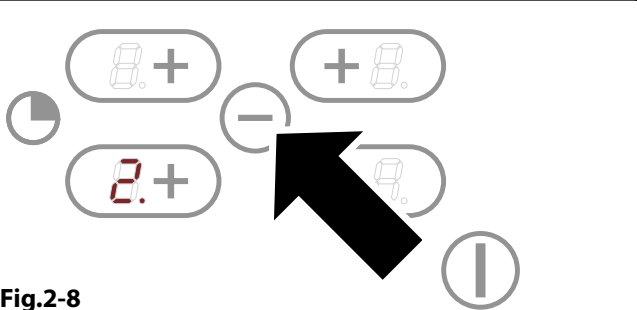

Fig.2-8



To reduce the power to a cooking zone select the required zone, as indicated by the red dot in the display. Press the '-' key to reduce the power required (**Fig.2-8**).

**Note:** The '-' key has a repeat function: holding the key pressed down will reduce the power setting by one level every 0.3 seconds.

**To shutdown a cooking zone:**

Make sure the required cooking zone has been selected, as indicated by the red dot in the display. Reduce the power to 0 (**Fig.2-9**). After three seconds have elapsed the element will automatically switch off.

**Rapid shutdown:**

To switch off a selected zone, press the '+' and '-' keys simultaneously: this will immediately switch off that zone (**Fig.2-10**).

**Note:** After a zone has been switched off an 'H' may flash in the display. This is a residual heat indicator that shows that the cooking zone temperature is above 60°C and may still cause burns. Once the temperature has dropped to below 60°C the 'H' will go out.

**To switch off all cooking zones:**

All of the cooking zones can be immediately switched off by pressing the On/Off key. Any 'hot' zones that were in use will show an 'H' in the display (**Fig.2-11**).

**Preheat Function**

This function allows for rapid heating up of the element to bring the selected cooking zone up to temperature. Once the zone is at the required cooking temperature the power level will reduce automatically to the preset level.

**To activate the preheat function:**

Select the required cooking zone. A red 'dot' will illuminate on the selected display to indicate that the zone has been selected.

1. Press the '-' key to bring the element up to full power (**Fig.2-12**).
2. Press the '+' key to activate the auto function, as indicated by the 'A' (**Fig.2-13**).
3. Using the '-' key, set the power to the desired preset level (**Fig.2-14**).

When the 'A' alternates with the selected power setting the preheat function is in operation.

**To adjust the preheat power level:**

Select the cooking zone (make sure the dot is illuminated) and then press the '+' key to increase the power level. Pressing the '-' key after the preheat is underway will interrupt the operation, switching off the preheat and leaving the cooking zone operating at one power level lower.

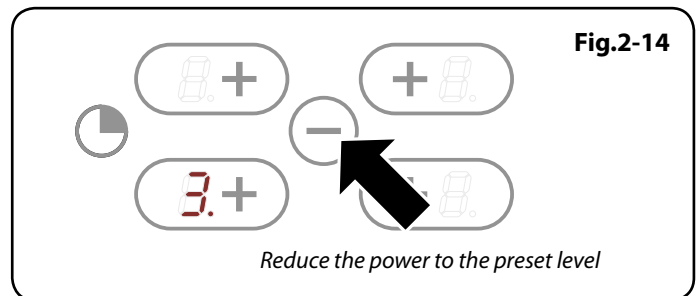
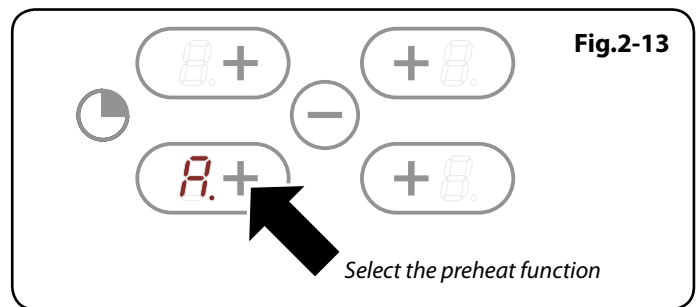
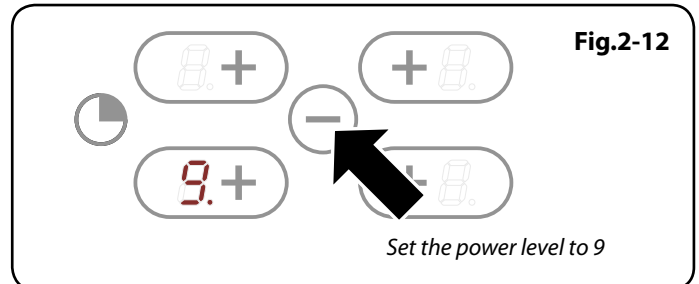
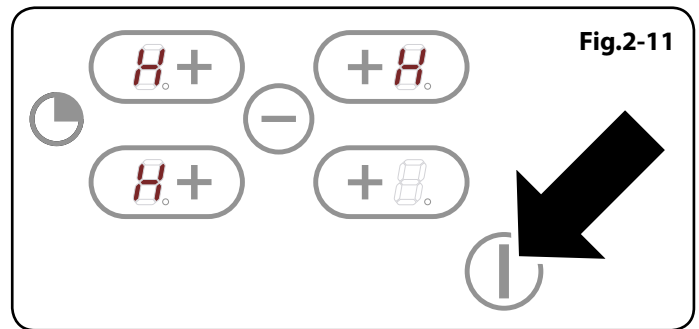
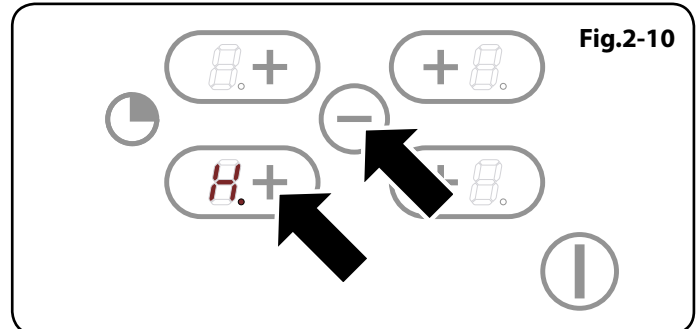
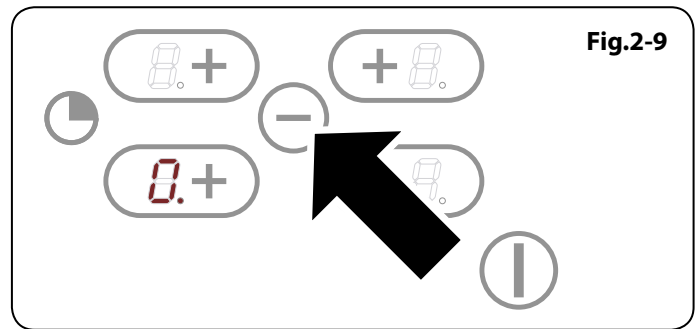
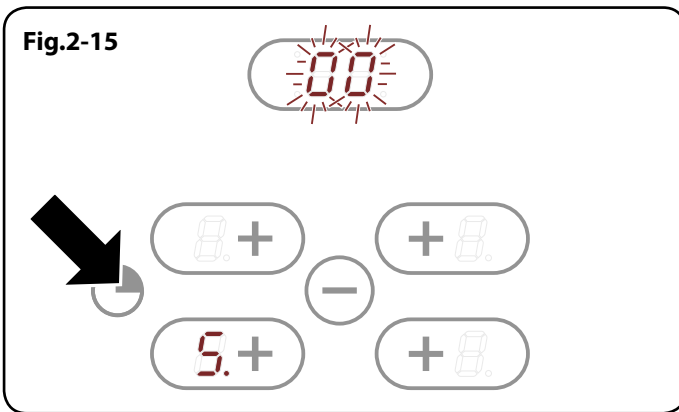

Fig.2-15



## Timer Function

The timer has two settings:

- Zone timer
- Minute timer

### Zone timer

This allows each cooking zone to be set to cook up to a maximum of 99 minutes at a set power level. At the end of the cooking time the zone will turn off automatically.

#### Activating the timer:

Select the required cooking zone and then:

1. Using the '+' and '-' keys, set the desired cooking temperature.
2. Press the timer key (**Fig.2-15**): the timer display will illuminate with '00' flashing.
3. Set the required cooking duration by pressing the timer key to increase the cooking time and the '-' key to reduce the cooking time (**Fig.2-16**).

**Note:** When the '00' is flashing, pressing the '-' key will set the timer to 60 minutes.

The timer will activate automatically within a few seconds and an indicator light will appear in the timer display corresponding the activated zone (**Fig.2-17**).

#### Changing a previously set cooking time:

Select the required cooking zone; the red dot will light up in the display. Press the timer key once then press the timer key to increase, or the '-' key to reduce, the cooking time.

#### Interrupting the timer:

Select the required cooking zone; the red dot will light up in the display. Press the timer key and, using the '-' key, reduce the cooking time to '00'. This will switch off the timer but leave the cooking zone on until manually deactivated.

#### Turning off the timer alarm:

At the end of the cooking time the hob will beep steadily for 2 minutes. Press any key to stop the alarm.

#### Cancelling the timer (rapid shutdown):

Select the required cooking zone; the red dot will light up in the display. Press both the '+' and '-' keys simultaneously. Note that this will turn off **both** the timer **and** the cooking zone immediately.

### Minute Timer

The timer can also be used as a simple minute timer, up to a maximum of 99 minutes.

#### Setting the timer:

Make sure that none of the cooking zones has been selected (if a zone has been accidentally selected simply leave the hob for 10 seconds: the dot in the zone display will go out). Press the timer key and then set the required time, using the timer and '-' keys (**Fig.2-18**).

Fig.2-16

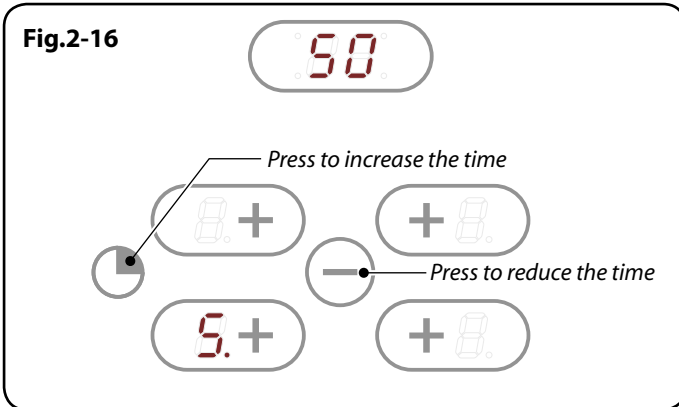

Fig.2-17

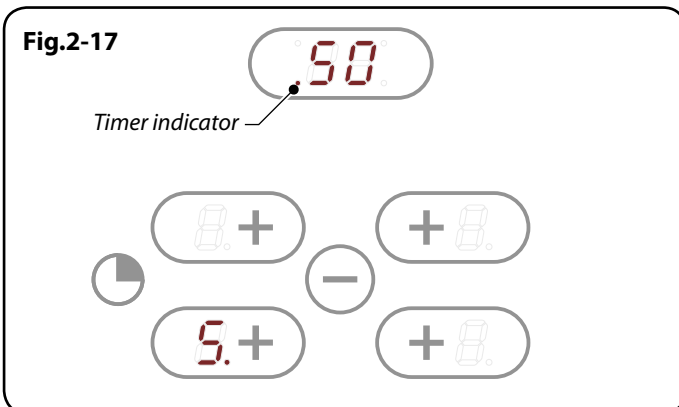
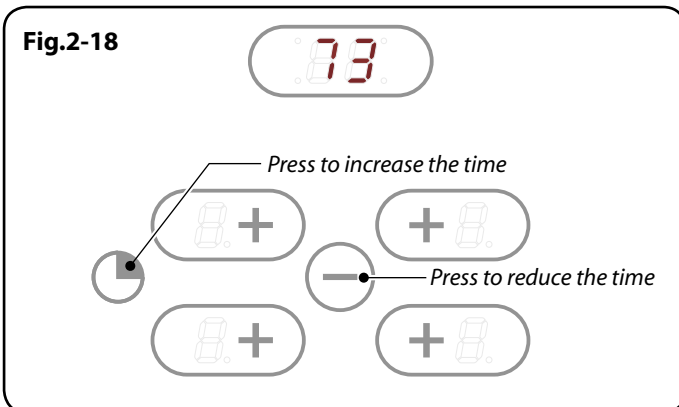

Fig.2-18





### Turning off the timer alarm:

At the end of the cooking time the hob will beep steadily for 2 minutes. Press any key to stop the alarm.

### Deactivating the timer:

Make sure that none of the cooking zones has been selected. Press the timer and '-' keys simultaneously. The timer display will go out.

## Child Lock Function

This allows the control panel to be locked to prevent any accidental use.

**IMPORTANT:** The child lock functions (activating and deactivating) can only be used when the hob has just been switched on: a red dot should show in all of the cooking zones (Fig.2-19).

### Activating the child lock:

Switch on the hob. Press the lower right cooking zone '+' key and '-' key simultaneously (the hob will beep) then press the lower right '+' key once again. The hob will beep and 'L' flashes in each of the zone displays (Fig.2-20). The hob is now locked. The child lock will remain on until it is unlocked. This includes switching the hob on and off and also if there is an interruption to the power supply.

**Note:** If a cooking zone is hot when locked, then 'L' and 'H' will flash alternately.

### Unlocking for cooking purposes:

Press and hold both the lower right cooking zone '+' key and the '-' key simultaneously. The 'L' in each of the digital displays will be replaced by a '0' and a flashing dot. After switching off the hob, the child lock function will remain activated.

**Note:** If a cooking zone is hot then '0' and 'H' will flash alternately.

### Deactivating the child lock:

Switch on the hob. Press the lower right cooking zone '+' key and '-' simultaneously (the hob will beep) then press the '-' key once more. The hob will beep and the 'L' in each of the zone displays will go out and the hob will switch off. When the hob is switched on again it is now unlocked.

## Automatic Shutdown

If the touch controls are continuously activated for longer than 10 seconds then the hob will shut down automatically. The hob will beep for 10 seconds, and the displays will show 'Er03' (Fig.2-21) as long as the touch controls are activated.

**Note:** If the cooking zone is hot then an 'H' will flash alternately along with the error code.

## Automatic Safety Shutdown

If any of the cooking zones has been left on by mistake the safety shutdown control will switch them off automatically after the time limit shown in the table is reached (Table 2-1).

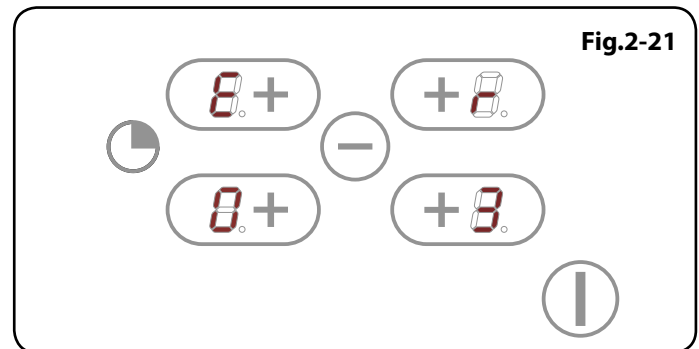
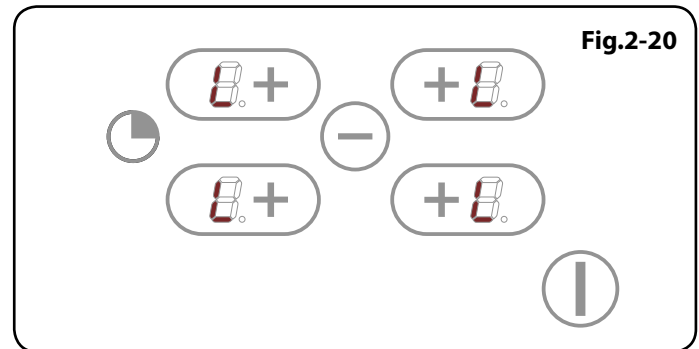
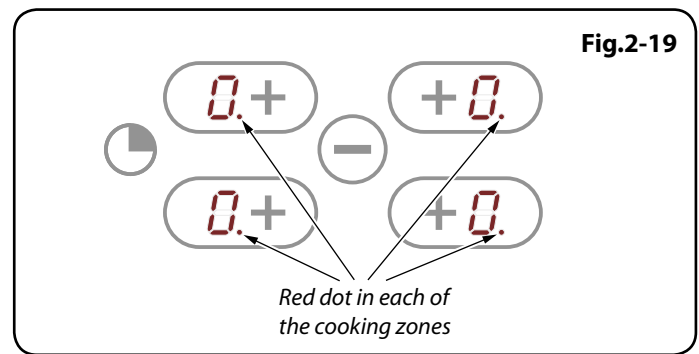

Power level	Operating limit
1	10 hours
2	5 hours
3	5 hours
4	4 hours
5	3 hours
6	2 hours
7	2 hours
8	2 hours
9	1 hour

Table 2-1

## 3. Cleaning Your Hob

### Essential information

Allow the hob to cool and isolate the electricity supply before carrying out any thorough cleaning.

*Never use paint solvents, washing soda, caustic cleaners, biological powders, bleach, chlorine based bleach cleaners, coarse abrasives or salt. Do not mix different cleaning products – they may react together with hazardous results.*

All parts of the hob can be cleaned with hot soapy water – but take care that no surplus water seeps into the appliance.

**Remember to switch on the electricity supply before re-using the hob.**

We have developed a range of cleaning products that give maximum performance without damaging the hob surface, in particular a Ceramic Hob Cleaner set with scraper. More information is available in the Cookware Collection brochure supplied with your hob and on our website, [www.rangemaster.co.uk](http://www.rangemaster.co.uk).

Regular cleaning is recommended. For easier cleaning, wipe away any spillages immediately.

### Daily care

First of all, make sure that all residual heat indicators are off and that the cooking surface is cool. Apply a small dab of ceramic cleaning cream in the centre of each area to be cleaned. Dampen a clean paper towel and work the cream onto the cooking surface. As a final step, wipe the cooking surface with a clean, dry paper towel.

### Cleaning spills

For spills and boil-overs that occur while cooking, turn off the unit and wipe the area surrounding the hot zone with a clean paper towel. If a spill (other than a sugary substance) is on the hot zone, do not clean until the unit has completely cooled down and then follow the instructions below, *'Cleaning burned-on spills'*.

If you accidentally melt anything on the surface, or if you spill foods with a high sugar content (preserves, tomato sauce, fruit juice, etc.), remove the spill IMMEDIATELY with a razor scraper, while the unit is still hot.

**IMPORTANT: Use an oven glove to protect your hand from potential burns.**

Scrape major spills or melted material from the cooking zone and push into a cold area. Then turn the unit 'OFF' and allow it to cool before cleaning further. After the cooking surface cools down and the residual heat indicator lights go off, follow the *'Daily care'* procedure outlined above.

### Cleaning burned-on spills

Make sure that the residual heat indicators are off and that the hob is cool. Remove the excess burned-on substance with a single-edged razor scraper. Hold the scraper at an angle of about 30° to the surface and then scrape off the burned-on matter (**Fig.3-1**).

Once you have removed as much as possible with the scraper, follow the *'Daily care'* procedure outlined above.

### To remove metal rub-off

Sliding pans on the hob – especially aluminium or copper pans – can leave marks on the surface. These marks often appear like scratches but can easily be removed using the procedure described previously for *'Cleaning spills'*. If the rub-off marks are especially stubborn, use a cleaning cream together with the razor scraper, as described in *'Cleaning burned-on spills'*.

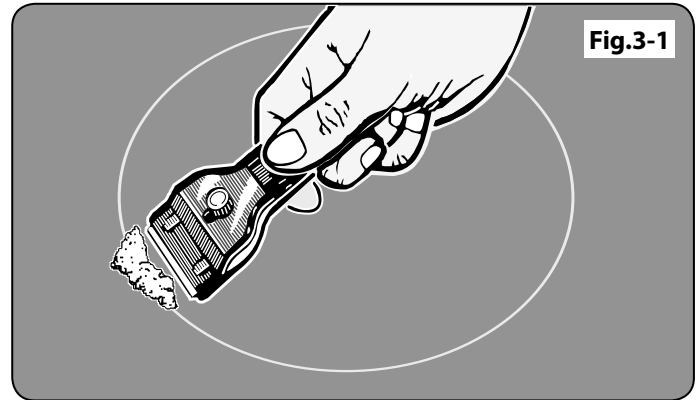

## 4. Troubleshooting

---

### **If there is an installation problem and I don't get my original installer to come back to fix it, who pays?**

You do. Service organisations will charge for their call-outs if they are correcting work carried out by your original installer. Therefore, it's in your own interest to keep track of this installer so that you can contact them as required.

### **A crack has appeared in the hob surface.**

Isolate the hob immediately from the power supply and arrange for its repair. Do not use the hob until it has been repaired.

### **The hob is scratched.**

Always use the cleaning methods recommended in this guide. Make sure that pan bottoms are smooth and clean.

Marks from aluminium and copper pans, as well as mineral deposits from water and food, can be removed with a cleaning cream. However, tiny scratches that are not removable will become less visible in time as a result of cleaning.

## INSTALLATION

Check the appliance is electrically safe when you have finished.

# 5. Installation

## Dear Installer

Before you start your installation, please complete the details BELOW.

Should your customer have a problem relating to your installation they will be able to contact you easily.

<b>Installer's Name</b>
<b>Installer's Company</b>
<b>Installer's Telephone number</b>
<b>Appliance Serial Number</b>

## Safety Requirements

The hob must be installed in a well ventilated space, in accordance with the section entitled '*Electrical Connection*'.

Read these instructions before installing or using the appliance.

## Provision of Ventilation

All rooms require a window that can be opened, or equivalent, while some rooms require a permanent vent in addition to the window.

## Location of the Hob

The hob may be installed in a kitchen/kitchen diner but NOT in a room containing a bath or shower.

This appliance is designed for domestic cooking only. Use for any other purpose could invalidate any warranty or liability claim.

**⚠ This appliance should not be installed in a boat or caravan.**

The hob must be installed in accordance with the relevant Building regulations and IEE regulations.

**You will need the following equipment to complete the hob installation satisfactorily:**

Multimeter (for electrical tests)

**You will also need the following tools:**

1. Electric drill
2. Jigsaw
3. Steel tape measure
4. Cross head screwdriver
5. Pencil
6. Sharp knife

## Checking the parts

Ceramic hob  
Fixing brackets and screws (4 off)  
Seal

Check that the appliance is in a good condition after having removed the packaging. In case of doubt, do not use the appliance and contact the retailer.

**Never leave the packaging materials (cardboard, plastic bags, polystyrene foam, etc.) within children's reach since they could become potential sources of danger.**

## INSTALLATION

Check the appliance is electrically safe when you have finished.

### Positioning the Hob

The hob should be fitted into a work surface, which is at least 600mm deep. In position, it has a maximum thickness of 5mm from the top of the work surface. The cut-out dimensions are shown in (Fig.5-1) and the minimum clearances in (Fig.5-2). The minimum recommended distances from the hob to nearby surfaces are shown in (Fig.5-3).

Any hob hood should be installed in accordance with the hood manufacturer's instructions.

Surfaces of furniture and walls at the sides and rear of the hob should be heat, splash and steam resistant. Certain types of vinyl or laminate kitchen furniture are particularly prone to heat damage and discolouration.

We cannot accept responsibility for damage caused by normal use of the hob to any material that de-laminates or discolours at temperatures less than 65°C above room temperature.

For safety reasons curtains must not be fitted immediately behind the hob.

### Fixing the Hob

The hob must be sealed to the work surface to prevent liquid from entering into the cabinet. A tape seal is supplied with the hob.

Carefully follow these instructions to correctly apply the seal: Turn the hob over and place in on a secure, level surface. Detach the seal from the backing, checking that the transparent protection still adheres to the seal itself. Carefully position the seal along the edge of the hob. Take special care in the corners making sure there are no gaps. The ends of the strips must fit together without overlapping.

If the surface that the hob is to be fitted to is tiled or is not reasonably smooth, additional sealing with a waterproof silicone sealant may be required.

Turn the hob back the right way up and position it in the worktop cut-out.

Secure the hob to the worktop using the brackets supplied. The positioning of the bracket is dependent on the thickness of the worktop as shown in (Fig.5-4).

**Note:** Slide the optional sleeve onto the bracket if fitting to thin work surfaces.

Locate the bracket to the slot on the hob base and then tighten the retaining screw until it is locked to the worktop.

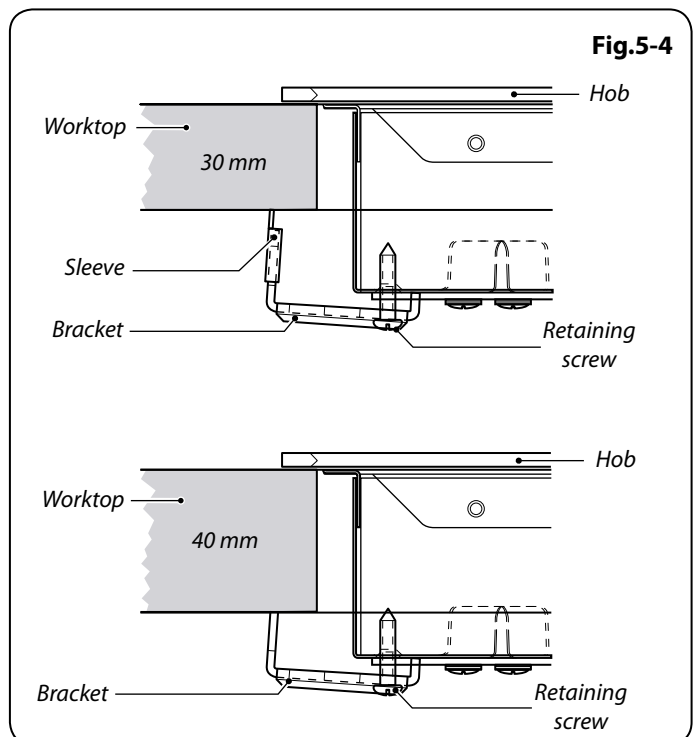
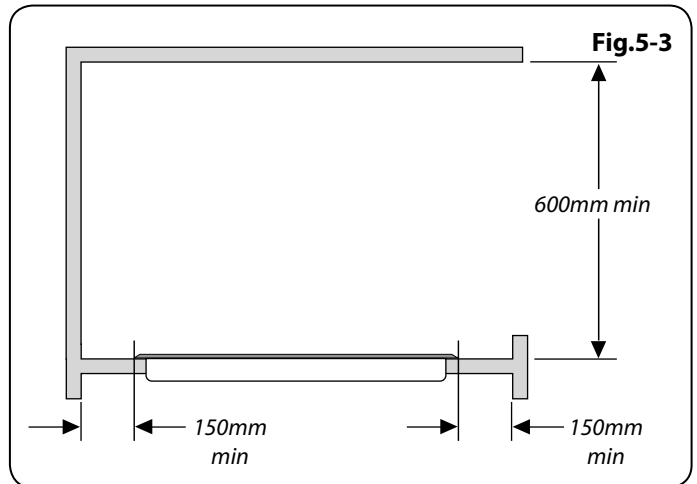
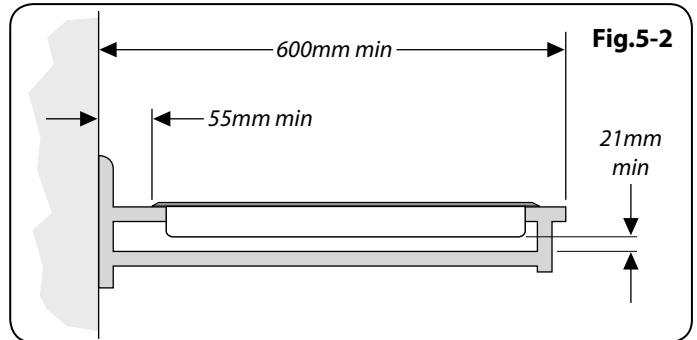
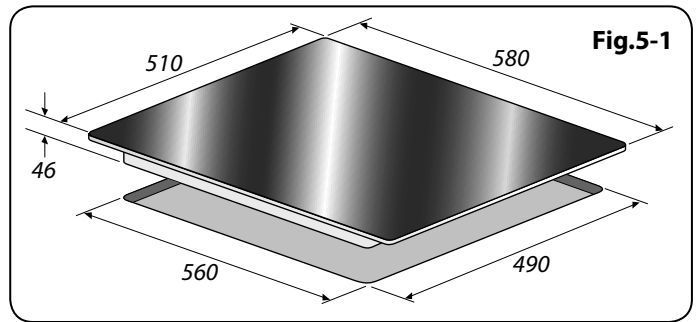

## INSTALLATION

Check the appliance is electrically safe when you have finished.

Fig.5-5

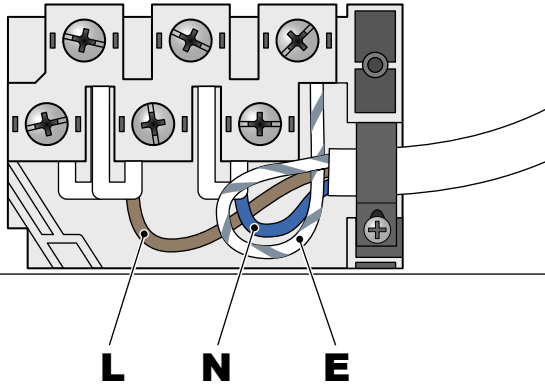

### Electrical Connections

This appliance must be installed by a qualified electrician to comply with the relevant Institute of Electrical Engineers (I.E.E.) regulations and also the local electricity supply company requirements.

**⚠ WARNING: THIS APPLIANCE MUST BE EARTHED**

**Note:** All external wiring must comply with the IEE Regulations for the Electrical Equipment of Buildings. Connection to the electrical supply can be made with either a plug and socket, or be permanently wired via a double pole switch. The hob is supplied with a 3-core cable, 2m long.

If a replacement cable is fitted it must be 250V high temperature PVC (85°C), 1mm<sup>2</sup> minimum conductor size.

Connect the hob up as shown (**Fig.5-5**).

**IMPORTANT:** The wires in the mains lead are coloured in accordance with the following code:

**Green and yellow: Earth**

**Blue: Neutral**

**Brown: Live**

### Hob Check

Check each cooking zone in turn.

### Customer Care

Please complete your contact details in the front of this section. Please inform the user how to operate the hob and hand over the instruction pack.

*Thank you.*

## 7. Circuit Diagram

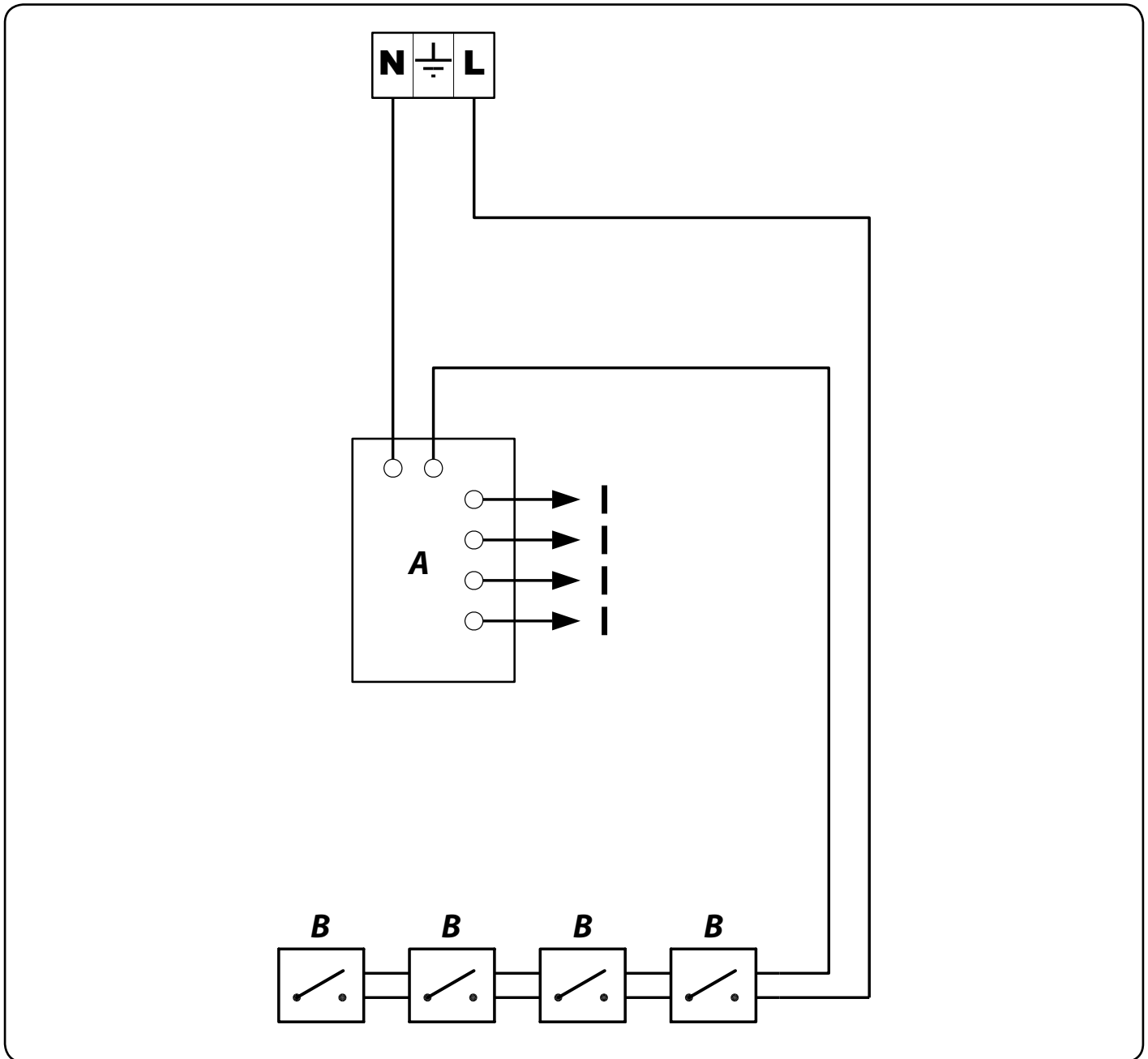

- A** Spark generator  
**B** Ignition switch

## 7. Technical Data

---

**INSTALLER:** Please leave these instructions with the user.

**DATA BADGE LOCATION:** Base of the hob

**COUNTRY OF DESTINATION:** GB/IE

### Dimensions

<b>Height</b>	Above worktop: 5mm	Below worktop: 40mm (60mm including connection box)
<b>Overall width</b>	580mm; see 'Positioning of the hob'	
<b>Overall depth</b>	510mm	
<b>Space for fixing</b>	See 'Positioning of the hob'	
<b>Minimum space above hotplate</b>	650mm	

### Connections

<b>Electric</b>
220 – 240V 50Hz

### Ratings

Maximum electric load at 230V 50Hz: 5.8kW

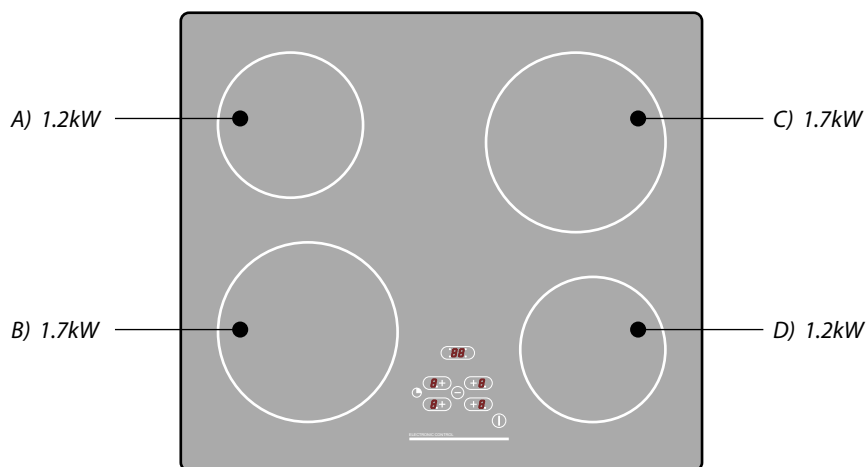



## 8. Warranty/After Sales Service

---

If consultation or technical assistance is needed, please provide the local authorised service agent with the purchase invoice and the product code/serial number.

The 2 years free maintenance for the operation of the appliance started from the date of purchase of this product.

Any cosmetic damage to the appliance must be reported within 90 days of delivery.

For in-warranty service please call: **0845 6035312**.

For general enquiries please call: **0870 7895107**.





# RANGEmaster

Clarence Street, Royal Leamington Spa,  
Warwickshire, CV31 2AD, England.  
Tel: +44 (0) 1926 457400 Fax: +44 (0) 1926 450526  
E-mail: [consumers@rangemaster.co.uk](mailto:consumers@rangemaster.co.uk)  
[www.rangemaster.co.uk](http://www.rangemaster.co.uk)



[www.rangemaster.co.uk](http://www.rangemaster.co.uk)

## Free Manuals Download Website

<http://myh66.com>

<http://usermanuals.us>

<http://www.somanuals.com>

<http://www.4manuals.cc>

<http://www.manual-lib.com>

<http://www.404manual.com>

<http://www.luxmanual.com>

<http://aubethermostatmanual.com>

Golf course search by state

<http://golfingnear.com>

Email search by domain

<http://emailbydomain.com>

Auto manuals search

<http://auto.somanuals.com>

TV manuals search

<http://tv.somanuals.com>