

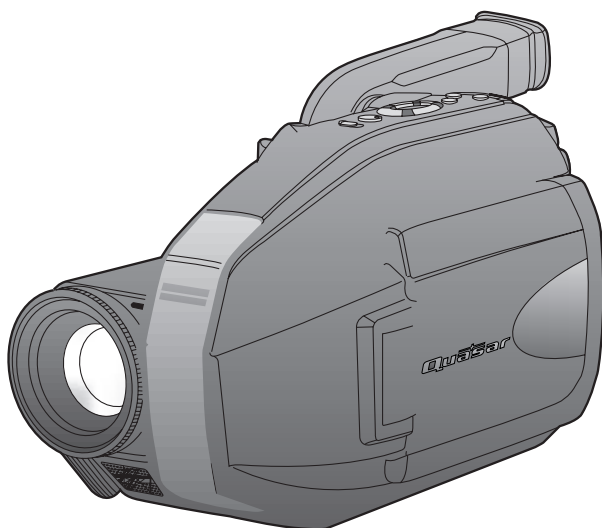

# Camcorder Operating Instructions

Model No. **VM-L152**



Getting Started

Basic Operation

Special Features

For Your Information

# Things You Should Know

## Thank you for choosing Panasonic!

You have purchased one of the most sophisticated and reliable products on the market today. Used properly, it will bring you years of enjoyment. Please take time to fill in the information to the right.

The serial number is on the tag located on the rear side of your Camcorder. Be sure to **retain this manual** as your convenient Camcorder information source.

Date of Purchase

Dealer Purchased From

Dealer Address

Dealer Phone No.

Model No.

Serial No.

## Unpack your Camcorder

These accessories are provided in order to set up or use your Camcorder.

1 pc. AC Adaptor (PV-A20)  
with DC Power Cable  
(page 9)



1 pc. Audio/Video Cable  
(LSJA0390) (pages 20, 21)



1 pc. Battery Pack  
(PV-BP15) (pages 8, 9)



1 pc. Shoulder Strap  
(LSFC0012) (page 11)



1 pc. CR2025 Clock  
Battery (VSBW0004)  
(installed in Camcorder)  
(page 32)



1 pc. Lens Cap (LSYK0818)  
with Lens Cap Strap  
(LSGQ0049) (page 11)



## Battery Charging Confirmation Marker



Use this marker as a reminder to yourself when the battery is fully charged or in need of a charge. This marker performs no function and is for your reference only.

### Safety Precautions

#### WARNING TO PREVENT EXPOSURE

Your Camcorder S Camcorder and Super Lo Play (SLP) recording on VHS

This Camcorder is compatible It is recommended VCR machine

RI

CAUTION: TO RE  
DO NOT  
NO USE

– This vide

m  
2  
plug having

02.2.18, 1:38 PM

15. **Power Lines** – An outside antenna system should not be located in the vicinity of overhead power lines or other electric light or power circuits, or where it can fall into such power lines or circuits. When installing an outside antenna system, extreme care should be taken to keep from touching such power lines or circuits as contact with them might be fatal.
16. **Overloading** – Do not overload wall outlets and extension cords as this can result in a risk of fire or electric shock.
17. **Objects and Liquids** – Never push objects of any kind into this video unit through openings as they may touch dangerous voltage points or short out parts that could result in a fire or electric shock. Never spill liquid of any kind onto the video unit.
18. **Servicing** – Do not attempt to service this video unit yourself as opening or removing covers may expose you to dangerous voltage or other hazards. Refer all servicing to qualified service personnel.
19. **Damage Requiring Service** – Unplug this video unit from the wall outlet and refer servicing to qualified service personnel under the following conditions:
  - a. When the power-supply cord or plug is damaged.
  - b. If any liquid has been spilled into, or objects have fallen onto, the video unit.
  - c. If the video unit has been exposed to rain or water.
  - d. If the video unit does not operate normally by following the operating instructions. Adjust only those controls that are covered by the operating instructions, as an improper adjustment of other controls may result in damage and will often require extensive work by a qualified technician to restore the video unit to its normal operation.
  - e. If the video unit has been dropped or the cabinet has been damaged.
  - f. When the video unit exhibits a distinct change in performance – this indicates a need for service.
20. **Replacement Parts** – When replacement parts are required, be sure the service technician has used replacement parts specified by the manufacturer or have the same characteristics as the original part. Unauthorized substitutions may result in fire, electric shock or other hazards.
21. **Safety Check** – Upon completion of any service or repairs to this video unit, ask the service technician to perform safety checks to determine that the video unit is in safe operating order.

## Precautions

### USE & LOCATION

- **TO AVOID SHOCK HAZARD ...** Your Camcorder and power supply should not be exposed to rain or moisture. Do not connect the power supply or operate your Camcorder if it gets wet. Your Camcorder has been designed for outdoor use, however it is not designed to sustain direct exposure to water, rain, sleet, snow, sand, dust, or a direct splashing from a pool or even a cup of coffee. This action could permanently damage the internal parts of your Camcorder. Do not attempt to disassemble this unit. There are no user serviceable parts inside. Unplug your Camcorder from the power supply before cleaning.
- **DO NOT AIM YOUR CAMCORDER AT THE SUN OR OTHER BRIGHT OBJECTS.**
- **DO NOT LEAVE THE CAMCORDER WITH THE EVF AIMED DIRECTLY AT THE SUN AS THIS MAY CAUSE DAMAGE TO THE INTERNAL PARTS OF THE EVF.**
- **DO NOT EXPOSE YOUR CAMCORDER TO EXTENDED HIGH TEMPERATURE ...** Such as, in direct sunlight, inside a closed car, next to a heater, etc... This action could permanently damage the internal parts of your Camcorder.
- **AVOID SUDDEN CHANGES IN TEMPERATURE ...** If the unit is suddenly moved from a cold place to a warm place, moisture may form on the tape and inside the unit.
- **DO NOT LEAVE YOUR CAMCORDER OR THE POWER SUPPLY TURNED ON WHEN NOT IN USE.**
- **STORAGE OF YOUR CAMCORDER ...** Store and handle your Camcorder in a manner that will not subject it to unnecessary movement (avoid shaking and striking). Your Camcorder contains a sensitive pick-up device which could be damaged by improper handling or storage.

### CARE

- **TO CLEAN YOUR CAMCORDER ...** Do not use strong or abrasive detergents when cleaning your Camcorder body.
- **TO PROTECT THE LENS ...** Do not touch the surface of the lens with your hand. Use a commercial camcorder lens solution and lens paper when cleaning the lens. Improper cleaning can scratch the lens coating.
- **TO PROTECT THE FINISH OF YOUR CAMCORDER ...** Before handling your Camcorder, make sure your hands and face are free from any chemical products, such as suntan lotion, as it may damage the finish.

# Table of Contents

## Getting Started

Things You Should Know .....	2~3
Important Safeguards .....	4~5
Precautions .....	5
Quick Operation Guide .....	7
Supplying Power (Battery Charge/Use/Refresh/Care, AC Adaptor, Car Battery Cord) .....	8~9
Cassette Information .....	10
Before Using (Remove the Sensor tag, Using the Shoulder and Hand Straps, Lens Cap) ....	11
Using MENU Mode .....	12
Setting the Clock (Time Zone, Auto Daylight Saving Time) .....	13~14
Built-in Auto Light (Using the Light, Replacing the Bulb) .....	15

## Basic Operation

Camera Recording (Basic, Stand-by, Programmed Recording) .....	16~18
Playing Back Recordings (Basic Playback, Visual Search, Still Picture, Tracking, TV/VCR Playback) .....	19~20
Copying your Tapes (dubbing) .....	21

## Special Features

Four-Speed Power Zoom .....	22
Backlight .....	22
Focus (Auto/Manual Focus) .....	23
High Speed Shutter (Auto/Manual Shutter) .....	24
Auto Fade .....	25
Color Digital Fade .....	26
Digital Zoom .....	27
Digital Electronic Image Stabilization (E.I.S.) .....	27
MotionSensor .....	28

## For Your Information

Viewfinder/LCD Monitor Indications .....	29~30
Operation Notes (Cleaning EVF) .....	31
Notice .....	31
Replacing Clock Battery .....	32
Palmcorder Accessory System .....	33
Palmcorder Accessory Order Form .....	34
Specifications .....	35
Request for Service Notice .....	35
Before Requesting Service (Video Head Cleaning) .....	36
Limited Warranty .....	37
Customer Services Directory .....	38
Spanish Quick Use Guide/Guía Para Uso Rápido .....	39
Index .....	40

# Quick Operation Guide

## Charging the Battery Pack

Charge Battery Pack fully before operation (page 8).

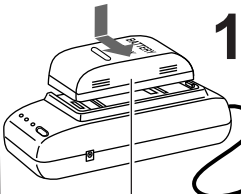
-  **1** Plug in **AC Adaptor**.
- 2** Insert **Battery**. **CHARGE** Lamp flashes, then stays lit when charging is complete.

## Insert Cassette

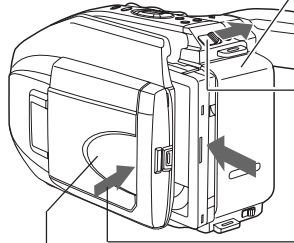

- 1** Attach fully charged **Battery** (page 8).
- 2** Slide **TAPE EJECT** to open door.
- 3** Insert **cassette** (page 10).
- 4** Press here to close door.

**Protection Film Note:**

- Remove the Protection Film before use.

## Camera Recording

See page 16.

- 1** Press **LCD-OPEN** to unlock the LCD monitor. Swing it fully open and adjust the angle.

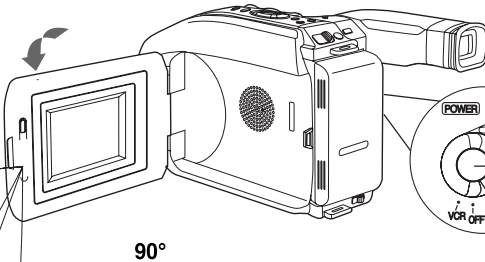

- 2** Set **POWER** to **CAMERA**.
- 3** Press **RECORD/PAUSE** to start recording. Press **RECORD/PAUSE** again to pause recording.

## Playback using the LCD Monitor

See page 19.

- 1** Press **LCD-OPEN** to unlock the LCD monitor. Swing it fully open and adjust the angle (see above).

- 2** Set **POWER** to **VCR**.

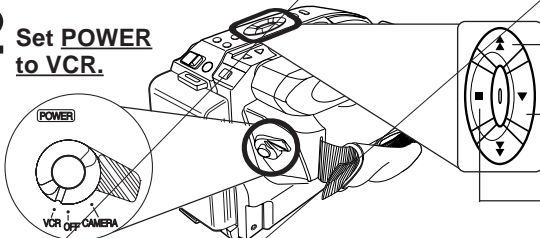

- 3** Press **REWIND/SEARCH** to rewind tape.
- 4** Press **PLAY** to start playback.
- 5** Press **STOP** to stop playback.

# Supplying Power

## Charging the Battery Pack

Charge Battery Pack fully before use.

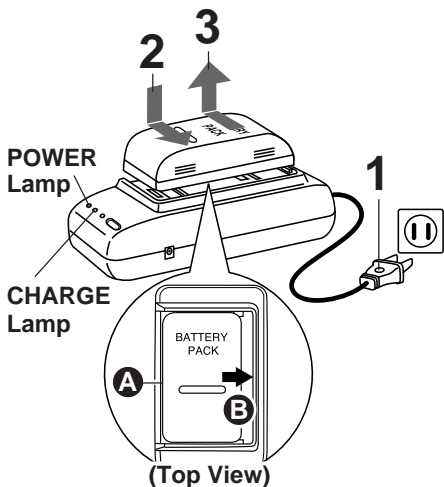

1

Plug in **AC Adaptor**.  
POWER Lamp lights.

2

Insert **Battery**.

- A Align left side of Battery with left edge of AC Adaptor.
- B Press Battery down and slide in direction of arrow.

The CHARGE Lamp flashes, then stays lit when charging is complete.

3

Remove **Battery**.

Slide Battery to the left and lift off.

**Note:**

- Charging takes about 1 hour.
- While the DC Power Cable (supplied) is connected to the AC Adaptor, the Battery cannot be charged.
- After charging 5 times, use Battery Refresh feature as explained below.
- Battery life gradually decreases after repeated use and recharging. If operation time becomes very short even after a sufficient charge, discard Battery properly (pages 9, 31).

## Using the Battery Pack

A fully charged Battery provides a maximum of about 1 hour 10 minutes of continuous use (LCD monitor off) or about 55 minutes (LCD monitor on). Actual time may vary due to operating conditions. Using the Built-in Light decreases operating time.

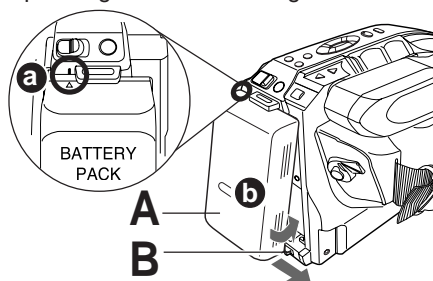

A

Attach **Battery**.

- a Insert top of Battery into top of mounting surface.
- b Press and snap into place.

B

Remove **Battery**.

Slide **BATTERY RELEASE** and remove Battery.

## Battery Refresh

This feature completely discharges Battery before recharging begins. Use after every 5 charges for optimum Battery performance.

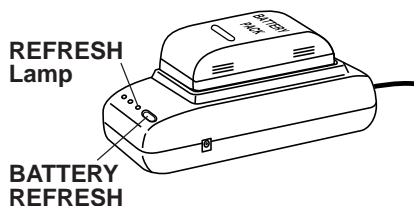

To use battery refresh, insert Battery on AC Adaptor (see steps 1~2 above), then press **BATTERY REFRESH**.

The REFRESH Lamp lights, then goes out when discharge is complete. Battery charging will then start automatically.

If **BATTERY REFRESH** is pressed by mistake, remove Battery from AC Adaptor and reinsert it for normal charging.

**Note:**

- Charging takes about 5 hours when Battery Refresh is used.
- Battery will not operate in extremely high temperatures.

8

For assistance, please call : 1-800-211-PANA(7262) or send e-mail to : [consumerproducts@panasonic.com](mailto:consumerproducts@panasonic.com)





# Cassette Information

## Cassette Insertion/Removal

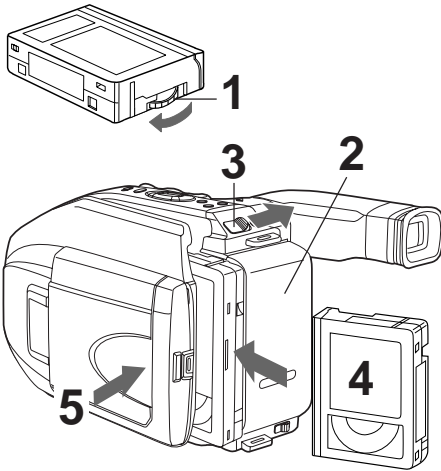

- 1** Turn **Tape Wheel** in direction of arrow until there is no slack.
- 2** Attach **Battery** (page 8).
- 3** Slide **TAPE EJECT** to open door.
- 4** Insert **cassette** as shown.
- 5** Press here to close door.

• To remove the cassette, slide the **TAPE EJECT** switch.

## Record/Playback Time

Use tapes with the **VHSC** mark in this unit.

Tape Speed Selector Position	Cassette type		
	TC-20	TC-30	TC-40
<b>SP</b> (Standard Play)	20 minutes	30 minutes	40 minutes
<b>SLP</b> (Super Long Play)	1 hour	1 hour 30 minutes	2 hours

• SLP playback may contain more picture noise.

## Erase Protection Tab

Protects tapes from being accidentally erased.

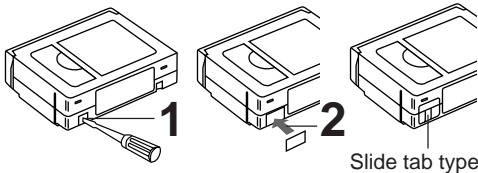

- 1** To prevent accidental erasing, **break off tab** with screwdriver. (Or, slide tab open.)
- 2** To record again, **cover hole** with adhesive tape. (Or, slide tab closed.)

ends into buckl

### Lens Cap

A



h to fit your hand as

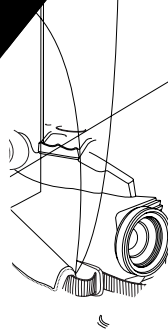

# Using MENU Mode

## Before you begin...

- Connect Camcorder to power source.
- Set POWER to CAMERA or VCR.

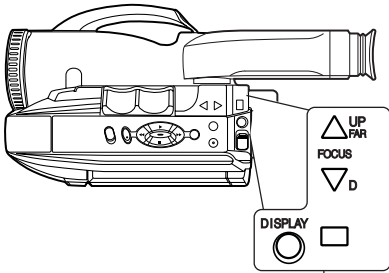

1, 2, 3, 4

- 1** Press **MENU** for MENU mode.  
The CAMERA or VCR MENU screen (see below left) appears when Menu mode is entered.
- 2** Press **UP** or **DOWN** to highlight the desired menu item.
- 3** Press **DISPLAY** to set selection.
- 4** Press **MENU** to exit.

### Note:

- The Menu mode is canceled if **UP/DOWN**, **DISPLAY**, or **MENU** are not pressed within 5 minutes when Self Demo mode is off.
- The Menu mode is canceled if **UP/DOWN**, **DISPLAY**, or **MENU** are not pressed within 30 seconds when Self Demo mode is on.

## MENU Mode (CAMERA) Screen

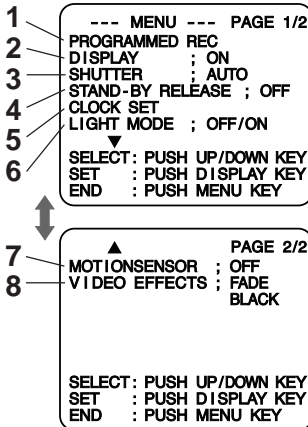

- 1 PROGRAMMED REC** (page 18).  
Camcorder starts and stops recording at a preset time.
- 2 DISPLAY** (page 29).  
ON : On-screen Display (OSD) screens are displayed.
- 3 SHUTTER** (page 24).  
Select desired shutter speed.
- 4 STAND-BY RELEASE** (page 17).  
ON : Enables quick resumption of recording from Stand-by mode.
- 5 CLOCK SET** (pages 13, 14).  
Select to set clock.
- 6 LIGHT MODE** (page 15).  
ON/OFF : Light can be set ON or OFF.  
ON/OFF/AUTO : Light can be set ON, OFF, or AUTO.
- 7 MOTIONSENSOR** (page 28).  
ON : Enables MotionSensor recording.
- 8 VIDEO EFFECTS** (pages 25~26).  
AUTO FADE : BLACK or WHITE  
DIGITAL FADE : TYPE → 7 types  
COLOR → 8 colors

## MENU Mode (VCR) Screen

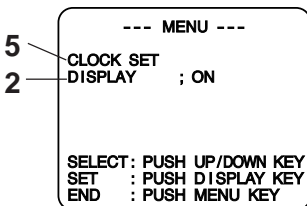

ck

Getting Started

AM  
002

# Setting the Clock

## 3a Setting the Time Zone

The Camcorder is preset to Eastern time.

### [ Time Zone chart ]

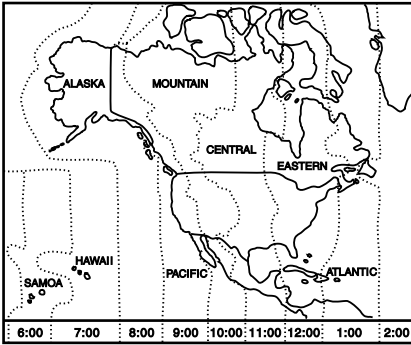

Press **UP** or **DOWN** to select local time zone.  
Press **DISPLAY** to confirm entry.

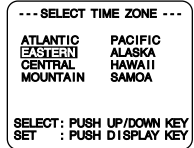

- When traveling, repeat this operation and select one of the 8 listed time zones to set the clock to local time.

#### Note :

- Clock may lose or gain up to 2 minutes per month.
- When traveling outside the listed time zones, set clock to local time manually.
- To adjust or set clock, see "Setting Date and Time" bottom of page.

## 3b Auto Daylight Saving Time

Clock will auto-adjust to daylight saving time (DST).

### DST: AUTO

**Spring (First Sunday in April) :**  
ahead one hour.

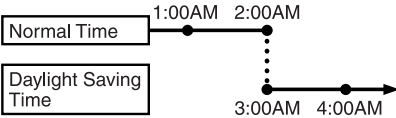

**Autumn (Last Sunday in October) :**  
back one hour.

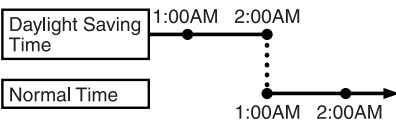

The Camcorder is preset to DST: **AUTO**. If DST is not observed in your area, set to **OFF** by doing the following.

Press **UP** or **DOWN** to select OFF or AUTO.  
Press **DISPLAY** to confirm entry.

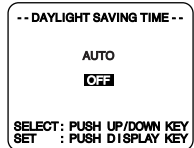

#### Note:

- Auto DST does not function if time zone is set to Hawaii or Samoa (see "Setting the Time Zone" above).

## 3c Setting Date and Time

Date and time including leap year are calculated up to DEC 31, 2099.

### EXAMPLE :

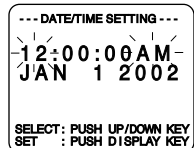
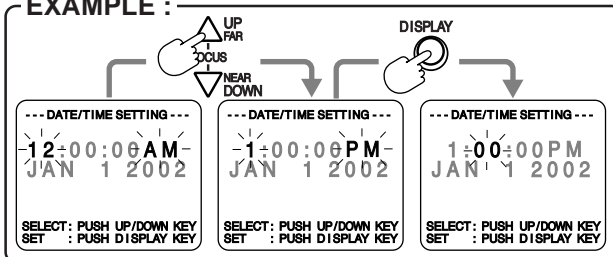

Press or hold down **UP** or **DOWN** to select hour, then press **DISPLAY** to fix.

Repeat for minute, month, day, and year.

Clock starts when year is entered and **DISPLAY** is pressed.

# Built-in Auto Light

## Using the Light

For recording in dim lighting.

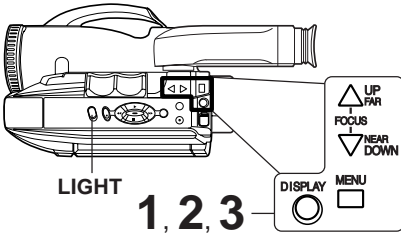

**CAUTION:**  
Light becomes hot.  
Never cover Light while on.

### Note:

- Using Light reduces battery operating time.
- Provide proper ventilation when using Light extensively in a hot environment.
- Using Light when the Camcorder is powered by a car battery may shorten bulb life.
- Set Light to OFF when not in use.

## Replacing the Bulb

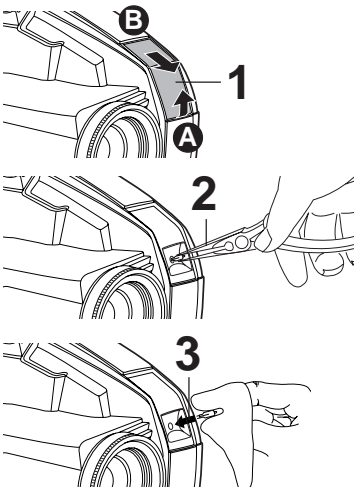

## DANGER:

Use only replacement bulb (PART NO. VLLW0015) supplied by Panasonic to reduce risk of fire.  
Handle new bulb with cloth or tissue as skin oils will decrease bulb life.  
Remove lens cover and allow bulb to cool before replacing to avoid possible burn hazard.

## Before you begin...

- Connect Camcorder to power source.
- Set POWER to CAMERA.

**1** Press **MENU** for MENU mode. Press **UP** or **DOWN** to select **LIGHT MODE**.

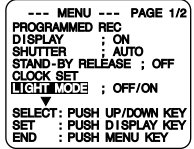

**2** Press **DISPLAY** to set OFF/ON or OFF/ON/AUTO. Press **MENU** to exit.

**3** Press **LIGHT** repeatedly for Light ON, OFF, or AUTO.  
• In AUTO, light turns itself on/off according to lighting conditions.

## EVF or LCD Monitor

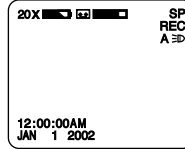

: Light is on.

: Light mode is auto.

## Before you begin...

- Order Part No. VLLW0015 for replacement bulb.
- Set POWER to OFF.

**1** Slightly raise portion **A** of lens cover to unhook, and slide portion **B** forward to remove.

**2** Using Tweezers or needle-nose pliers, carefully remove bulb.  
• Take unit to service center if you need assistance.

**3** Replace bulb using a clean cloth or tissue. (Do not touch with fingers.)

**4** Replace lens cover.

### Note:

- Handle bulb gently. Excessive force may cause bulb to crack.





# Camera Recording

## Before you begin...

- Connect Camcorder to power source.
- Insert cassette with record tab (page 10).

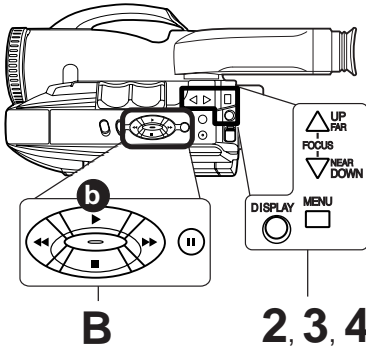

**B**

**2, 3, 4**

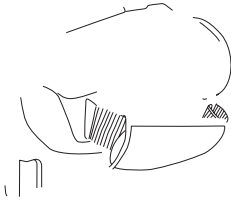

**1, b, c,  
A, C**

## Stand-by Quick Release

If left in RECORD/PAUSE mode for 5 minutes, Camcorder switches to Stand-by mode to conserve battery. When set to ON, Stand-by Quick Release lets you resume recording by pressing RECORD/PAUSE two times. Stand-by Quick Release is set to OFF at the factory.

**1** Set POWER to CAMERA.

**2** Press MENU for MENU mode.  
Press UP or DOWN to select STAND-BY RELEASE.

**3** Press DISPLAY to select ON/OFF.

**ON** : From Stand-by mode, press RECORD/PAUSE two times to resume recording.

**OFF** : From Stand-by mode, set POWER to OFF, then to CAMERA. Press RECORD/PAUSE to record.

**4** Press MENU to exit.

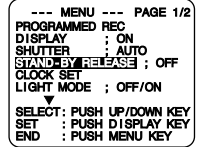

Basic Operation

## Manual Easy Editing

For proper continuity when taping from Stop mode or after attaching a new Battery.

**A** Set POWER to VCR.

**B** **a** Press REWIND/SEARCH to rewind a few seconds of tape.

**b** Press PLAY to review recording.

**c** Press STILL where you want to continue recording.

**C** Set POWER to CAMERA.

**D** Press RECORD/PAUSE to resume recording.

## Easy Edit Stand-by

For a smooth transition between scenes if recording is stopped, and then started within 24 hours.

**a** Press RECORD/PAUSE to stop recording.

**b** Set POWER to OFF and leave cassette in Camcorder.

**c** To resume recording, set POWER to CAMERA.

**d** Press RECORD/PAUSE to resume recording.

### Note:

- Use Manual Easy Edit (left) if more than 24 hours before recording is resumed.



# Playing Back Recordings

## Before you begin...

- Connect Camcorder to power source.
- Insert recorded tape.



## Tracking Control



# Playing Back Recordings

## TV Playback or Viewing

Connect Camcorder to a TV to view playback or recordings in progress.

### Connections

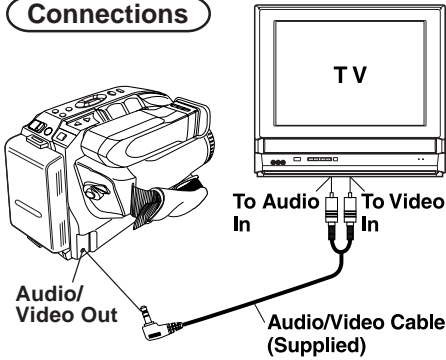

## Before you begin...

- Connect Camcorder to power source.
- Make all TV-Camcorder connections.

- 1** Set **POWER** to:  
**VCR** → view playback.  
**CAMERA** → view picture as it is recorded.
- 2** Turn **TV ON** and set to **LINE INPUT**.  
See TV owner's manual.
- 3** Begin playback or recording.

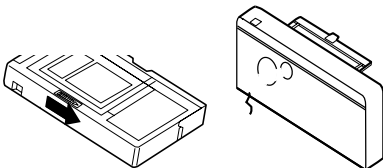

# Copying your Tapes (dubbing)

## Connections

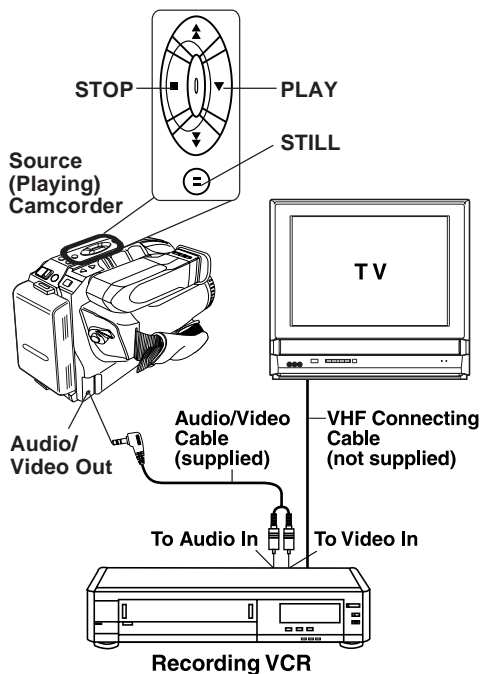

## Before you begin...

- Make Camcorder-VCR connections (see left).
- Turn both units on.
- Set VCR input signal to LINE.  
Please see VCR owner's manual.
- Set Camcorder POWER to VCR.

- 1** Insert a pre-recorded tape into Camcorder and a blank tape with record tab into VCR.
- 2** Press PLAY on Camcorder, then press STILL at starting point.
- 3** Press REC, then STILL/PAUSE on VCR.
- 4** Press STILL on Camcorder and STILL/PAUSE on VCR to start copying.
- 5** Press STOP on both units to stop copying.

## Note:

- Camcorder will only playback tapes recorded in SP or SLP mode.
- Dubbing may reduce picture quality.

## CAUTION:

Unauthorized exchanging and/or copying of copyrighted recordings may be copyright infringement.

## Monitor with your TV

- Turn TV on and tune to VCR channel (CH3 or CH4).
- Set TV/VCR Selector on VCR to VCR.

# Four-Speed Power Zoom

Zoom in (close up) and out (wide angle) in one of four speeds ranging from slow (16 seconds) to fast (2 seconds).

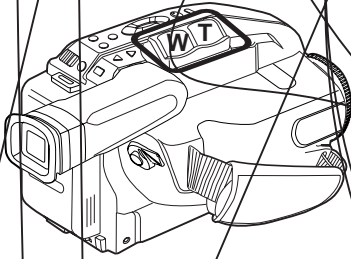

## Before you begin...

- Connect Camcorder to power source.
- Set POWER to CAMERA.

### Zoom In ("T")

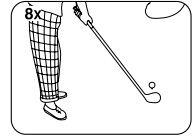
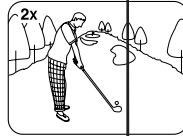

Zoom Out ("W")

### Zoom slowly:

Lightly press "T" (telephoto) or "W" (wide angle) POWER ZOOM button.

### Zoom quickly:

Apply more pressure to the button.

Use when subject is darker than surroundings, in shadowed area, or in front of the light source.

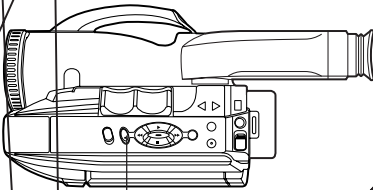

B.LIGHT

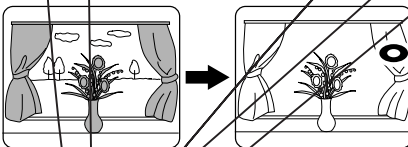

## Before you begin...

- Connect Camcorder to power source.
- Set POWER to CAMERA.

Press **B.LIGHT** while recording to select the level of backlight compensation.

In normal lighting, press **B.LIGHT** repeatedly until no indicator is displayed.

### EVF Indications

Normal (No Indication)

First press (Low)

Second press (Medium)

Third press (High)

Fourth

## Before you begin...

- Connect Camcorder to power source.
- Set POWER to CAMERA.

## Auto Focus

Camcorder automatically focuses on subject even during zooming.

Auto Focus is on when "MF" is not displayed in EVF or LCD monitor.

Press **M.FOCUS** to remove "MF" in EVF or LCD monitor if necessary.

## Manual Focus

Use Manual Focus (MF) when :

- recording through glass.
- lighting is poor.
- subject is far away with objects in foreground.
- subject has distinct horizontal lines.
- subject is not centered in EVF or LCD monitor.
- subject has a shiny surface.
- subject is slanted.
- subject is bright and flat, like a white wall.
- subject has fast motion, like a golf swing.

EVF or LCD Monitor

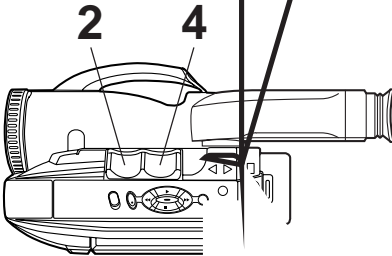

**1** Press **M.FOCUS** so "MF" (Manual Focus) appears in EVF or LCD monitor.

**2** Hold down **"T" (telephoto)** on **POWER ZOOM** to maximum zoom in.

**3** Press **UP (FAR)** or **DOWN (NEAR)** until subject is in focus.  
 • Back away from subject if necessary.

**4** Hold down **"W" (wide angle)** on **POWER ZOOM** as desired.

- **Refocus as needed** when aiming at new scenes.

## Macro Focus (close-ups)

Auto Focus functions up to 12.7 mm (1/2 inch) from subject.

Hold down **"W"** on **POWER ZOOM** to maximum wide angle.

Bring Camcorder up close to the subject.

# High Speed Shutter

Improves Still or Slow Motion playback picture of high speed subjects (e.g. a tennis stroke), when viewed on Camcorder or 3 or 4 head VCR.

## Auto Shutter

In AUTO mode (no indication in EVF or LCD Monitor), shutter speed is auto-adjusted from 1/60 to 1/350 according to subject brightness.

- AUTO mode is selected each time POWER is set to CAMERA.

## Manual Selection

The faster the shutter speed, the more light is needed for proper picture and color quality. High Speed Shutter indication flashes if light is inadequate. Provide additional light.

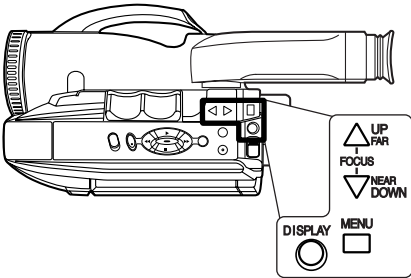

1, 2, 3

## Before you begin...

- Connect Camcorder to power source.
- Insert cassette with record tab (page 10).
- Set POWER to CAMERA.

**1** Press **MENU** for MENU mode.  
Press **UP** or **DOWN** to select **SHUTTER**.

**2** Press **DISPLAY repeatedly** to select shutter speed.

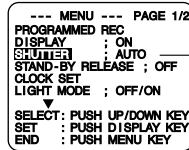

→ AUTO → 1/60 → 1/100 → 1/250 → 1/500  
← 1/10000 ← 1/4000 ← 1/2000 ← 1/1000 ←

**3** Press **MENU** to exit.

## Note:

- Shutter speed cannot be set to 1/60 if Digital E.I.S. feature is set to ON.
- Provide additional halogen or tungsten light for use indoors or in poor light. Fluorescent light degrades picture.
- Auto Focus may not function properly if high speed shutter is used in inadequate light.
- Setting reverts to AUTO each time POWER is set to CAMERA.



# Auto Fade

interesting way to open and close  
rees.

## Before you begin...

- Connect Camcorder to power source.
- Set POWER to CAMERA.

**1** Press **MENU** for MENU mode.  
Press **UP** or **DOWN** to select **VIDEO EFFECTS**.

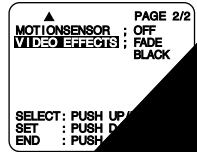

**2** Press **DISPLAY** for VIDEO EFFECTS menu. Press **UP** or **DOWN** to select **AUTO FADE**.

**3** Press **DIS** for AUTO FADE menu. Press **UP** or **DOWN** to select **FADE**.

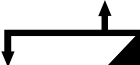
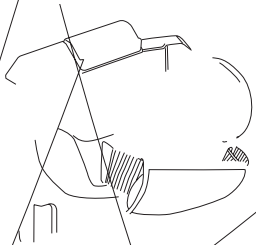

Special Features

Press **FADE** on the LCD monitor.

Picture and sound

Recording, press **FADE** so "FA" appears on the EVF or LCD monitor.

Press **RECORD/PAUSE**. Picture and sound gradually fade and recording is paused.

If **FADE** is pressed again, "FADE" disappears from the monitor.

# Color Digital Fade

Choose from 7 fade effects in 8 different colors.

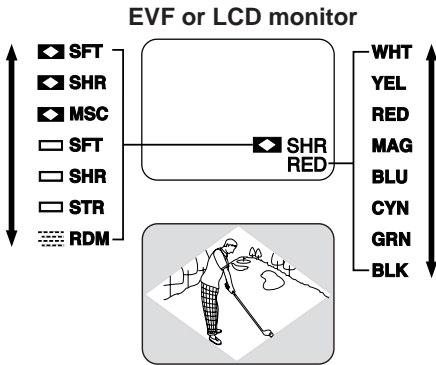
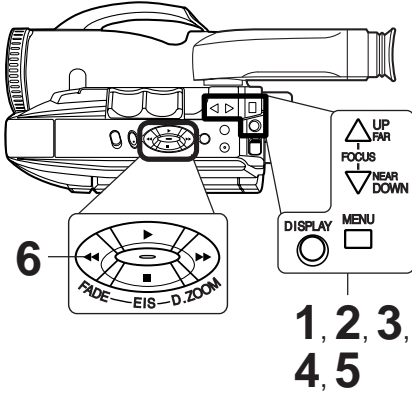

- For more effects, stop fade in or fade out at any time (except RANDOM mode) by pressing **FADE**. Then, press **FADE** to resume fade.

**Note:**

- Audio is not affected by fade.
- To cancel Digital Fade, do steps 1, 2, and 5. In step 2, select AUTO FADE.

## Before you begin...

- Connect Camcorder to power source.
- Set POWER to CAMERA.

**1** Press **MENU** for MENU mode.  
Press **UP** or **DOWN** to select **VIDEO EFFECTS**.

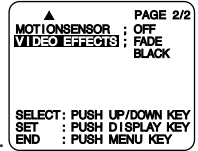

**2** Press **DISPLAY** for VIDEO EFFECTS menu.  
Press **DOWN** to select **DIGITAL FADE**.

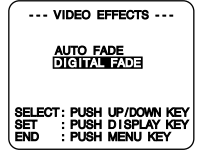

**3** Press **DISPLAY** for DIGITAL FADE menu.  
Press **UP** or **DOWN** to select **TYPE**.  
Press **DISPLAY** for TYPE menu.  
Press **UP** or **DOWN** to select from 7 different types of fades.  
• A preview of each fade type is displayed as it is selected.

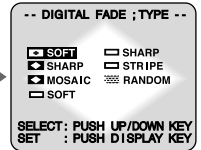
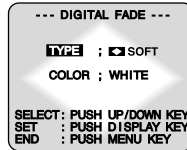

**4** Press **DISPLAY** for DIGITAL FADE menu.  
Press **DOWN** to select **COLOR**.  
Press **DISPLAY** for COLOR menu.  
Press **UP** or **DOWN** to select from 8 colors.  
• A preview of each color is displayed as it is selected.

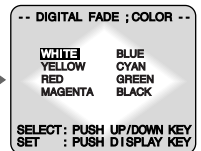
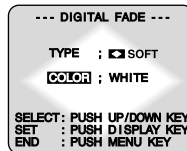

**5** Press **DISPLAY** to confirm entry.  
Press **MENU** twice to exit.

**6** Press **FADE** for about 2 seconds to fade out during recording (selected fade type flashes). Press **FADE** again to fade in.

Power Zoom magnification is digitally increased.

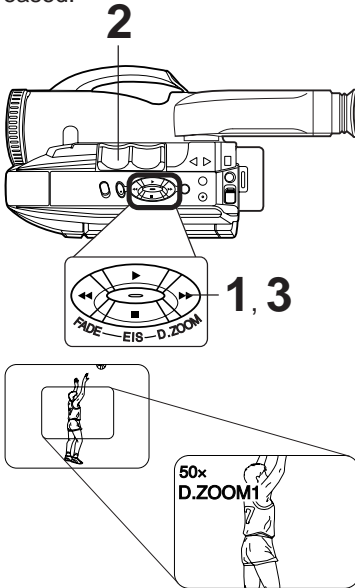

## Before you begin...

- Connect Camcorder to power source.
- Set POWER to CAMERA.

**1** Press **D. ZOOM** once → D.ZOOM 1 (150x maximum)  
twice → D.ZOOM 2 (700x maximum)  
The Higher digital magnification levels may cause picture distortion.

**2** Hold down **"T"** on **POWER ZOOM**.  
Digital Zoom starts when normal zoom reaches maximum (20x).  
• Zoom level appears in EVF.  
• POWER ZOOM switch controls digital zoom level.  
• Normal zoom resumes when level falls to 20x.

**3** Press **D. ZOOM** to turn off Digital Zoom so no indication appears.

# Digital Electronic Image Stabilization (E.I.S.)

Helps stabilize picture when recording in unstable situations.

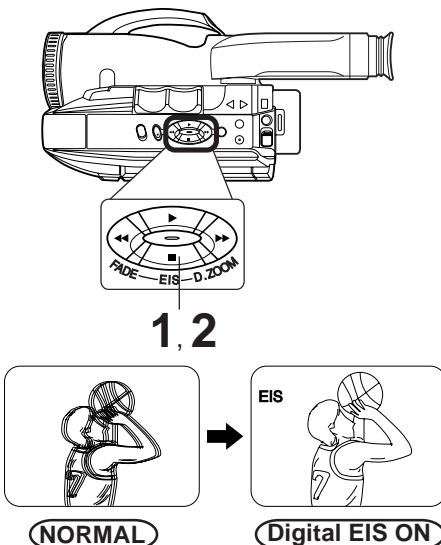

## Before you begin...

- Connect Camcorder to power source.
- Set POWER to CAMERA.

**1** Press **EIS** to display "EIS" in the EVF.  
• Image becomes slightly enlarged and shutter speed auto-adjusts from 1/80 to 1/350 according to brightness.  
• Use High Speed Shutter (page 24) if needed. Shutter speed setting remains after EIS is canceled.

**2** Press **EIS** again to cancel when not in use.

## E.I.S. may not function during...

- extreme Camcorder movement.
- recording of subjects with distinct horizontal or vertical stripes.
- low light situations (EIS indicator flashes).
- intense fluorescent lighting situations.
- recording of very fast motion.

orce.  
lings.  
age 10).

order.

PAGE 2/2  
MOTION SENSOR : OFF  
EFFECTS : FADE  
BLACK  
: PUSH UP/DOWN KEY  
: PUSH DISPLAY KEY  
: PUSH MENU KEY

or stand-by  
rted, "REC"

REC  
MOTION  
SENSOR

seconds  
if displayed  
e 14).  
seconds after

et **POWER**

Camcorder  
ng normal  
, the  
able: Record/  
E.I.S., Video

# Viewfinder/LCD Monitor Indications

Tape remaining and battery charge level can be displayed.

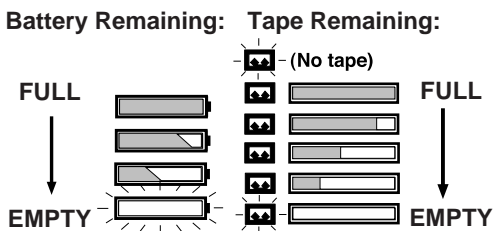
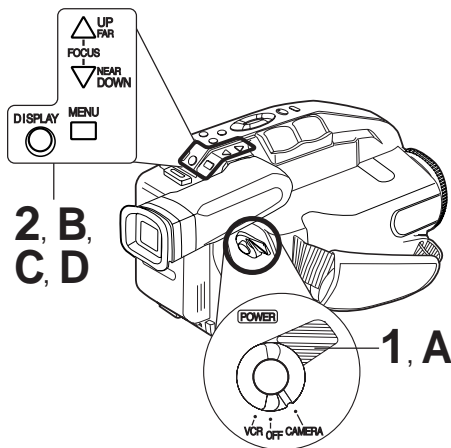

## Before you begin...

- Connect Camcorder to power source.

**1** Set POWER to CAMERA.

**2** Press DISPLAY repeatedly to select the following displays.

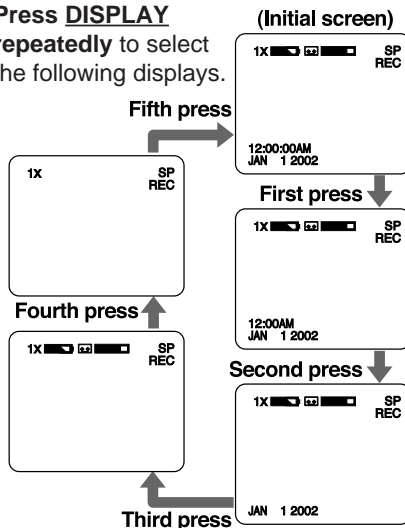

- Tape remaining indicator operates a few seconds after tape starts moving.

## Recording the Date and Time

**a** Do steps 1 and 2 above to select time/date, date only, or no display.

**b** Start a recording (page 16).  
• Only the Date and/or Time are recorded.

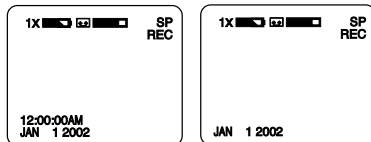

## Display-Off Mode

- A** Set POWER to CAMERA or VCR.
- B** Press MENU for MENU mode.  
Press UP or DOWN to select DISPLAY.
- C** Press DISPLAY to select OFF.  
Press MENU to exit.
- D** Press DISPLAY repeatedly to remove time/date.

Indications are restored the next time Camcorder is turned on.

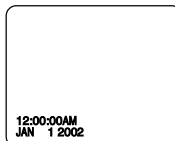
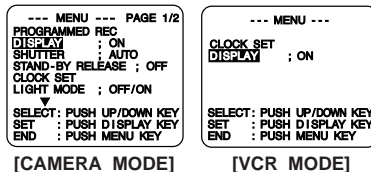



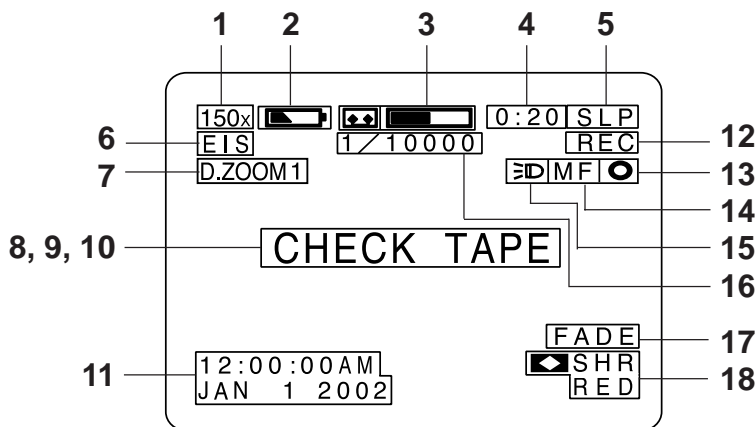

For Your Information

# Viewfinder/LCD Monitor Indications

## CAMERA/VCR mode



- 1 Zoom Magnification level** (pages 22, 27).
- 2 Battery Remaining**  (page 29).  
“WARNING LOW BATTERY” appears and Camcorder shuts off after 15 seconds.
- 3 Tape Remaining** (page 29).  
“” flashes and “TAPE END” appears for 5 seconds when:
  - End of tape is reached.
 “” flashes for 1 minute and “CHECK TAPE” appears for 5 seconds when:
  - RECORD/PAUSE is pressed with no cassette, or cassette has no record tab in Camera (RECORD) mode.
  - PLAY, FF or REW is pressed with no cassette inserted in VCR mode.
- 4 10-Second Reminder**  
Each time a recording is started, a 10 second incremental display (up to 59:50) lets you monitor how long one scene is recorded.  
 0:00 0:10 0:20 . . . . . 59:50  
  
 (return to 0:00 and continue)
- 5 TAPE SPEED** (pages 10, 16).  
(SP=standard play, SLP=super long play).
- 6 Digital E.I.S.** (page 27).
- 7 Digital Zoom** (page 27).
- 8 VCR-MODE**  
“VCR-MODE” appears for 1 minute when POWER is set to VCR or if RECORD/PAUSE is pressed in VCR mode.
- 9 DEW**  
If moisture condensation occurs in unit, “WARNING DEW DETECTED” appears, and Camcorder will shut off in 15 seconds. Wait until “WARNING” no longer indicates when Camcorder is turned on to use.
- 10 MotionSensor** (page 28).
- 11 Date and Time** (pages 13, 14).
- 12 Operating Mode**
  - REC (record)
  - PAUSE
  - FF (fast forward)
  - PLAY
  - REW (rewind)
- 13 Backlight** (page 22).
- 14 Manual Focus** (page 23).
- 15 Light ON/OFF/AUTO** (page 15).
- 16 High Speed Shutter** (page 24).
- 17 Fade** (page 25).
- 18 Color Digital Fade** (page 26).

## Cleaning EVF (Electronic Viewer Finder)

### To Remove

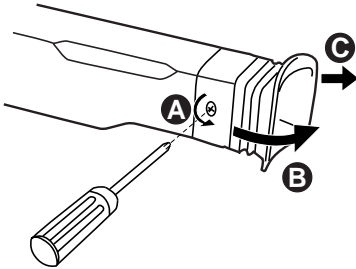

- 1** **A** Remove the screw with a Phillips screwdriver.  
Turn counterclockwise.  
**B** Turn the EVF Eyepiece.  
**C** Pull the EVF Eyepiece.
- 2** Remove any lint or dust particles with a soft clean cloth being careful not to scratch the glass surfaces.
- 3** Replace the EVF Eyepiece and the screw.

## Notice

This product utilizes both a Cathode Ray Tube (CRT) and other components that contain lead. It also has a fluorescent lamp containing a small amount of mercury. Disposal of these materials may be regulated in your community due to environmental considerations. For disposal or recycling information please contact your local authorities, or the Electronics Industries Alliance: <<http://www.eiae.org>>

### ATTENTION :



A nickel cadmium battery that is recyclable powers the product you have purchased. At the end of its useful life, under various state and local laws, it is illegal to dispose of this battery into your municipal waste stream. Please call 1-800-8-BATTERY for information on how to recycle this battery.

# Replacing Clock Battery

The clock battery is pre-installed. Follow the steps below if replacement becomes necessary.

## WARNING:

Replace battery with Panasonic PART NO. VSBW0004 (CR2025) only. Use of another battery may present a risk of fire or explosion.

Caution: Battery may explode if mistreated. Dispose of used battery promptly. Keep away from children. Do not recharge, disassemble or dispose of in fire.

## Clock Battery

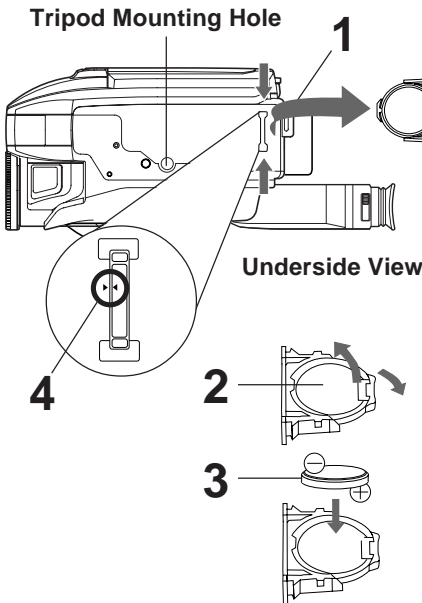

- 1** While pinching the 2 tabs, pull Battery Tray out.
- 2** Bend middle tab out and remove Battery.
- 3** Snap new Battery (⊕ mark down) into Battery Tray.
  - Do not reverse the polarity.
- 4** Insert Battery Tray so the triangle marks meet.

### Note:

- Keep Battery out of children's reach. Swallowing it may be harmful.
- Improper installation, discharge, or missing battery causes "CLOCK BATTERY" to appear when DISPLAY is pressed.
- Battery life is approximately 5 years.



# Palmcorder Accessory System

To order instructions, see the Accessory Order Form page.

- The listed standard battery use times are based on continuous recording using this Palmcorder.

Accessory #	Figure	Description	Price
PV-A19		AC Adaptor with DC Power Cable (Charging of the Nickel Cadmium Battery or Nickel Metal Hydride Battery)	Call For Pricing
PV-A20		AC Adaptor with DC Power Cable (Charging of the Nickel Cadmium Battery or Nickel Metal Hydride Battery)	Call For Pricing
HHR-V60A/1B		Up to 6 hr Battery Pack (Rechargeable Nickel Metal Hydride Battery)	\$119.95
HHR-V40A/1B		Up to 4 hr Battery Pack (Rechargeable Nickel Metal Hydride Battery)	\$69.95
HHR-V20A/1B		Up to 2 hr Battery Pack (Rechargeable Nickel Metal Hydride Battery)	\$59.95
PV-AA6		"AA" Battery Case	\$20.00
PV-C16		Car Battery Cord	\$70.00
PV-P1		VHS PlayPak	\$39.95
PV-H18A		Soft Sided	\$49.95

**Note:**

- Prices subject to change without notice.

For Your Information

# Palmcorder Accessory Order Form

Please photocopy this form when placing an order.

1. Palmcorder Model # \_\_\_\_\_

2. Items Ordered

Accessory #	Description	Price Each	Quantity	Total Price
Subtotal				
Your State & Local Sales Tax				
Shipping & Handling				6.95
Total Enclosed				

3. Method of payment (check one)

- Check or Money Order enclosed (NO C.O.D.SHIPMENTS)
- VISA                      Credit Card # \_\_\_\_\_
- MasterCard              Expiration Date \_\_\_\_\_
- Discover                      Customer Signature \_\_\_\_\_

Make Check or Money Order to: PANASONIC ACCESSORIES

(Please do not send cash)

4. Shipping information (UPS delivery requires complete street address)

Ship To:

Mr.

Mrs.

Ms.

First \_\_\_\_\_ Last \_\_\_\_\_

Phone #:

Day (    ) \_\_\_\_\_

Street Address \_\_\_\_\_

Night (    ) \_\_\_\_\_

City \_\_\_\_\_ State \_\_\_\_\_ Zip \_\_\_\_\_

TO OBTAIN ANY OF OUR PALMCORDER ACCESSORIES YOU CAN DO ANY OF THE FOLLOWING:

VISIT YOUR LOCAL PANASONIC DEALER

OR

CALL PANASONIC'S ACCESSORY ORDER LINE AT 1-800-332-5368

[6 AM-5 PM M-F, 6 AM-10:30 AM SAT, PACIFIC TIME]

OR

MAIL THIS ORDER TO: PANASONIC SERVICES COMPANY ACCESSORY ORDER OFFICE

20421 84th Avenue South Kent, WA. 98032

# Specifications

<b>Power Source:</b>	Compact VHS Camcorder: DC 6 V AC Adaptor: 110/120/220/240 V AC, 50/60 Hz Battery: Nickel-Cadmium Type DC 6 V
<b>Power Consumption:</b>	Compact VHS Camcorder: 6V DC 8.5 W (Max. 11.5 W) AC Adaptor: 19 W 1.2 W (when not in use.)
<b>Video Signal:</b>	EIA Standard (525 lines, 60 fields) NTSC color signal
<b>Video Recording System:</b>	2 rotary heads plus flying erase head. Helical scanning system
<b>Audio:</b>	1 track
<b>Pick-Up System:</b>	Sequential color difference field reverse system
<b>Pick-Up Device:</b>	One integral color filter Charge Coupled Device (CCD)
<b>Lens:</b>	20:1 zoom lens, F1:1.6 with auto iris control Focal length: 3.6 mm - 72 mm 4 speed power zoom function
<b>Viewfinder:</b>	10.2 mm (0.4 inch) Electronic Viewfinder
<b>LCD Monitor:</b>	63.5 mm (2.5 inch) Liquid Crystal Display
<b>Minimum Illumination Required:</b>	0.8 lx (F1:1.6) 0.08 footcandles 7 lx (F1:1.6) 0.7 footcandles (EIA Standard)
<b>Operating Temperature:</b>	0 °C~40 °C (32 °F~104 °F)
<b>Operating Humidity:</b>	10 %~75 %
<b>Weight:</b>	Compact VHS Camcorder: 1.00 kg 2.20 lbs. AC Adaptor: 0.3 kg 0.66 lbs.
<b>Dimensions:</b>	Compact VHS Camcorder: 106 (W) × 125 (H) × 190.5 (D) mm 4-3/16 (W) × 4-15/16 (H) × 7-1/2 (D) inch AC Adaptor: 68 (W) × 41 (H) × 140 (D) mm 2-11/16 (W) × 1-5/8 (H) × 5-1/2 (D) inch

Weight and dimensions shown are approximate.  
Designs and specifications are subject to change without notice.

## Request for Service Notice

Please photocopy this form when making a request for service notice.

### Request for Service Notice:

In the unlikely event this product needs service.

- Please include your **proof of purchase**. (Failure to do so will delay your repair.)
- To further speed your repair please provide an explanation of what is wrong with the unit and any symptom it is exhibiting.

---

---

---

Mail this completed form and your Proof of Purchase along with your unit to:  
Panasonic Services Company  
1705 N. Randall Road  
Elgin, IL. 60123-7847  
Attn: Camcorder Repair

# Before Requesting Service

If a problem arises, you may be able to correct it yourself.  
See Symptom and Correction list below.

Symptom	Correction
No picture in EVF or LCD monitor ...	<ul style="list-style-type: none"> <li>• Connect Power Source. (pp. 8, 9)</li> <li>• Set POWER to VCR or CAMERA. (pp. 16, 19)</li> <li>• Check for Dew Indication. (p. 30)</li> <li>• Use fully charged Battery. (p. 8)</li> <li>• Firmly connect all needed cables. (p. 9)</li> </ul>
Video cassette cannot be inserted ...	<ul style="list-style-type: none"> <li>• Connect Power Source. (pp. 8, 9)</li> <li>• Insert cassette, window side facing out. (p. 10)</li> </ul>
Video cassette cannot be removed ...	<ul style="list-style-type: none"> <li>• Connect Power Source. (pp. 8, 9)</li> </ul>
Operation buttons do not work ...	<ul style="list-style-type: none"> <li>• Check for Dew Indication. (p. 30)</li> </ul>
Recording cannot be done ...	<ul style="list-style-type: none"> <li>• Make sure record tab is intact. (p. 10)</li> <li>• Check Battery Indicator. (p. 29)</li> <li>• Check for Dew Indication. (p. 30)</li> </ul>
Auto Focus does not operate ...	<ul style="list-style-type: none"> <li>• Set FOCUS to AUTO. (p. 23)</li> <li>• Set POWER to CAMERA. (p. 16)</li> </ul>
Sound from microphone can't be monitored ...	<ul style="list-style-type: none"> <li>• Set unit to REC or Record/Pause mode.</li> </ul>
Camera picture is too dark ...	<ul style="list-style-type: none"> <li>• Set HIGH SPEED SHUTTER to AUTO. (p. 24)</li> </ul>
No playback picture, or the playback picture is noisy or contains streaks ...	<ul style="list-style-type: none"> <li>• Press UP/DOWN button during playback (Tracking Control). (p. 19)</li> </ul>
Top of playback picture waves back and forth excessively ...	<ul style="list-style-type: none"> <li>• A playback signal is not as stable as an off the air TV signal, so the top of your TV screen may appear bent or unstable during playback. This is called, "Horizontal AFC time constant change." To correct, slowly turn the TV horizontal hold control. If your TV does not have this control, or adjusting it does not help, contact your TV service center. (Some nominal service charges may be required.)</li> </ul>

## Video Head Cleaning



**Clogged Video Head**

While head cleaning is normally not needed, playing old or damaged tapes may clog the heads. When playback picture resembles example at the left, head cleaning is required.

Ideally, head cleaning should be performed by a qualified service technician. When this is not possible, purchase a head cleaning cassette. Be sure to follow cleaning cassette instructions exactly and only use when symptoms occur.

# Limited Warranty

PANASONIC CONSUMER ELECTRONICS COMPANY,  
DIVISION OF MATSUSHITA ELECTRIC  
CORPORATION OF AMERICA  
One Panasonic Way Secaucus, New Jersey 07094

PANASONIC SALES COMPANY, DIVISION OF MATSUSHITA  
ELECTRIC OF PUERTO RICO, INC.,  
AVE. 65 de Infañtería, Km. 9.5 San Gabriel Industrial Park,  
Carolina, Puerto Rico 00985

## Panasonic/Quasar Video Products Limited Warranty

### Limited Warranty Coverage

If your product does not work properly because of a defect in materials or workmanship, Panasonic Consumer Electronics Company or Panasonic Sales Company (collectively referred to as "the warrantor") will, for the length of the period indicated on the chart below, which starts with the date of original purchase ("warranty period"), at its option either (a) repair your product with new or refurbished parts, or (b) replace it with a new or a refurbished product. The decision to repair or replace will be made by the warrantor.

Product	Parts	Labor	Service	Contact Number
Camcorder	One (1) Year (except CCD Image Sensor) CCD Image Sensor - 6 (Six) Months	Ninety (90) Days Ninety (90) Days	Carry-In or Mail-In	1-800-211-PANA(7262)
DVD/VCR Deck, A/V Mixer	One (1) Year	Ninety (90) Days	Carry-In or Mail-In	1-800-211-PANA(7262)
TV/VCR, TV/DVD, TV/DVD/VCR Combination	One (1) Year (except CRT) CRT - Two (2) Years	Ninety (90) Days Ninety (90) Days	Carry-In: 21" CRT and Smaller In-Home or Carry-In: 22" CRT and Larger	1-800-211-PANA(7262)
TV/HDR Combination	One (1) Year (except CRT) CRT - Two (2) Years	Ninety (90) Days Ninety (90) Days	In-Home or Carry-In	1-888-843-9788
Rechargeable Batteries (in exchange for defective item)	Ten (10) Days	Not Applicable	Carry-In or Mail-In	1-800-211-PANA(7262)
Tape (in exchange for defective item)	Five (5) Days	Not Applicable	Carry-In or Mail-In	1-800-211-PANA(7262)
Memory Cards (in exchange for defective item)	Ninety (90) Days	Not Applicable	Carry-In or Mail-In	1-800-211-PANA(7262)

During the "Labor" warranty period there will be no charge for labor. During the "Parts" warranty period, there will be no charge for parts. You must carry-in or mail-in your product or arrange for in-home service, as applicable, during the warranty period. If non-rechargeable batteries are included, they are not warranted. This warranty only applies to products purchased and serviced in the United States or Puerto Rico. This warranty is extended only to the original purchaser of a new product which was not sold "as is". A purchase receipt or other proof of the original purchase date is required for warranty service.

### Carry-In, Mail-in or In-Home Service

For Carry-In, Mail-In or In-Home Service (as applicable) in the United States call toll free contact number listed above or visit Panasonic Web Site: <http://www.panasonic.com>

For assistance in Puerto Rico call Panasonic Sales Company (787)-750-4300 or fax (787)-768-2910.

In-Home service, if applicable, requires clear, complete and easy access to the product by the authorized servicer and does not include removal or re-installation of an installed product. It is possible that certain in-home repairs will not be completed in-home, but will require that the product, or parts of the product, be removed for shop diagnosis and/or repair and then returned.

### Limited Warranty Limits And Exclusions

This warranty ONLY COVERS failures due to defects in materials or workmanship, and DOES NOT COVER normal wear and tear or cosmetic damage, nor does it cover markings or retained images on the picture tube resulting from viewing fixed images (including, among other things, letterbox pictures on standard 4:3 screen TV's, or non-expanded standard 4:3 pictures on wide screen TV's, or onscreen data in a stationary and fixed location). The warranty ALSO DOES NOT COVER damages which occurred in shipment, or failures which are caused by products not supplied by the warrantor, or failures which result from accidents, misuse, abuse, neglect, mishandling, misapplication, alteration, faulty installation, set-up adjustments, misadjustment of consumer controls, improper maintenance, power line surge, lightning damage, modification, or commercial use (such as in a hotel, office, restaurant, or other business), rental use of the product, service by anyone other than a Factory Servicenter or other Authorized Servicer, or damage that is attributable to acts of God.

**THERE ARE NO EXPRESS WARRANTIES EXCEPT AS LISTED UNDER "LIMITED WARRANTY COVERAGE". THE WARRANTOR IS NOT LIABLE FOR INCIDENTAL OR CONSEQUENTIAL DAMAGES RESULTING FROM THE USE OF THIS PRODUCT, OR ARISING OUT OF ANY BREACH OF THIS WARRANTY.** (As examples, this excludes damages for lost time, cost of having someone remove or re-install an installed unit if applicable, or travel to and from the servicer, loss of media or images, data or other memory or recorded content. The items listed are not exclusive, but are for illustration only.) **ALL EXPRESS AND IMPLIED WARRANTIES, INCLUDING THE WARRANTY OF MERCHANTABILITY, ARE LIMITED TO THE PERIOD OF THE LIMITED WARRANTY.**

Some states do not allow the exclusion or limitation of incidental or consequential damages, or limitations on how long an implied warranty lasts, so the exclusions may not apply to you.

This warranty gives you specific legal rights and you may also have other rights which vary from state to state. If a problem with this product develops during or after the warranty period, you may contact your dealer or Servicenter. If the problem is not handled to your satisfaction, then write to the warrantor's Consumer Affairs Department at the addresses listed for the warrantor.

**PARTS AND SERVICE (INCLUDING COST OF AN IN-HOME SERVICE CALL, WHERE APPLICABLE) WHICH ARE NOT COVERED BY THIS LIMITED WARRANTY ARE YOUR RESPONSIBILITY.**

For Your Information

# Customer Services Directory

*For Product Information, Operating Assistance, Literature Request, Dealer Locations, and all Customer Service inquiries please contact:*

**1-800-211-PANA (7262), Monday-Friday 9 am-9 pm; Saturday-Sunday 9 am-7 pm, EST. or send e-mail : [consumerproducts@panasonic.com](mailto:consumerproducts@panasonic.com)**

**Web Site: <http://www.panasonic.com>**

**You can purchase parts, accessories or locate your nearest servicer by visiting our Web Site.**

## **Accessory Purchases:**

**1-800-332-5368 (Customer Orders Only )**

**Panasonic Services Company 20421 84th Avenue South, Kent, WA 98032**

**(Monday-Friday 6 am-5 pm; Saturday 6 am-10:30 am, PST)**

**(Visa, MasterCard, Discover Card, American Express, Check)**

## **Product Repairs**

### **Centralized Factory Servicer**

**MAIL TO :** Panasonic Services Company  
1705 N. Randall Road,  
Elgin, IL 60123-7847  
Attention: Camcorder Repair

Please carefully pack and ship, prepaid and insured, to the Elgin Centralized Factory Servicer. Customer's in Puerto Rico, please ship or carry in to location below ("Service in Puerto Rico").

### **Service in Puerto Rico**

**Matsushita Electric of Puerto Rico, Inc. Panasonic Sales Company/ Factory Servicer:  
Ave. 65 de Infanteria. Km. 9.5, San Gabriel Industrial Park, Carolina, Puerto Rico 00985  
Phone (787) 750-4300 Fax (787) 768-2910**

As of February 2002



# Index

- A**  
AC Adaptor ..... 9  
Accessories (Optional) ... 33  
Accessories (Supplied) .... 2  
Audio/Video Cable ... 20, 21  
Audio/Video Out ..... 20, 21  
Auto Daylight Saving Time  
..... 14
- B**  
Backlight ..... 22  
Battery Pack ..... 8, 9  
BATTERY RELEASE  
Button ..... 8  
Before Requesting Service  
..... 36  
B.LIGHT Button ..... 22  
BRIGHT ADJUSTMENT  
..... 16, 19  
Built-in Microphone ..... 16
- C**  
Camera Recording ... 16~18  
Car Battery Cord ..... 9  
Cassette Information ..... 10  
Charging Battery ..... 8  
Cleaning EVF ..... 31  
Clock Battery ..... 32  
Clock Set ..... 13, 14  
Copying your Tapes ..... 21
- D**  
DC IN ..... 9  
DC Power Cable ..... 9  
Digital E.I.S. .... 27  
Digital Zoom ..... 27  
DISPLAY Button . 12, 19, 29  
Display-off Mode ..... 29  
D.ZOOM Button ..... 27
- E**  
EIS Button ..... 27
- F**  
Fade ..... 25, 26  
FADE Button ..... 25, 26  
FAST FORWARD/SEARCH  
Button ..... 19  
Focus ..... 23
- H**  
Hand Strap ..... 11  
High Speed Shutter ..... 24
- L**  
LCD Monitor ..... 16, 19  
LCD-OPEN Button ... 16, 19  
Lens Cap ..... 11  
Light ..... 15  
LIGHT Switch ..... 15  
Limited Warranty ..... 37
- M**  
MENU Button ..... 12  
MENU Mode ..... 12  
M.FOCUS Button ..... 23  
MotionSensor ..... 28
- P**  
PLAY Button ..... 19  
Playback ..... 19, 20  
PlayPak (Optional) ..... 20  
Power Supply ..... 8, 9  
POWER Switch ..... 16, 19  
POWER ZOOM Button  
..... 22, 23, 27  
Programmed Recording . 18
- Q**  
Quick Operation Guide .... 7
- R**  
RECORD/PAUSE Button 16  
Record/Playback Time ... 10  
Replacing Clock Battery . 32  
Request for Service Notice  
..... 35  
REWIND/SEARCH  
Button ..... 19
- S**  
Safety Precautions ..... 3  
Servicenter List ..... 38  
Shoulder Strap ..... 11  
Speaker ..... 19  
Special Effects ..... 19  
Specifications ..... 35  
STILL Button ..... 19  
Still Picture ..... 19  
STOP Button ..... 19
- T**  
Tab ..... 10  
TAPE EJECT Switch 10, 16  
TAPE SPEED Button ..... 16  
Tracking Control ..... 19  
Tripod Mounting Hole .... 32
- U**  
UP (FAR) / DOWN (NEAR)  
Button ..... 12, 19, 23
- V**  
VHF Connecting Cable .. 21  
Video Cassettes (tapes) . 10  
Video Head Cleaning ..... 36  
Viewfinder/LCD Monitor  
Indications ..... 29~30  
Viewing (TV/VCR) ..... 20  
VISION ADJUSTMENT .. 16  
VOLUME ..... 19
- Z**  
Zoom ..... 22, 27

**Panasonic Consumer Electronics Company,**  
**Division of Matsushita Electric Corporation of America**  
One Panasonic Way Secaucus, New Jersey 07094



Printed in Indonesia  
LSQT0598A  
S0202Y0



## Free Manuals Download Website

<http://myh66.com>

<http://usermanuals.us>

<http://www.somanuals.com>

<http://www.4manuals.cc>

<http://www.manual-lib.com>

<http://www.404manual.com>

<http://www.luxmanual.com>

<http://aubethermostatmanual.com>

Golf course search by state

<http://golfingnear.com>

Email search by domain

<http://emailbydomain.com>

Auto manuals search

<http://auto.somanuals.com>

TV manuals search

<http://tv.somanuals.com>