

**AT110**

DC2950

Treadmill

# Owner's Manual

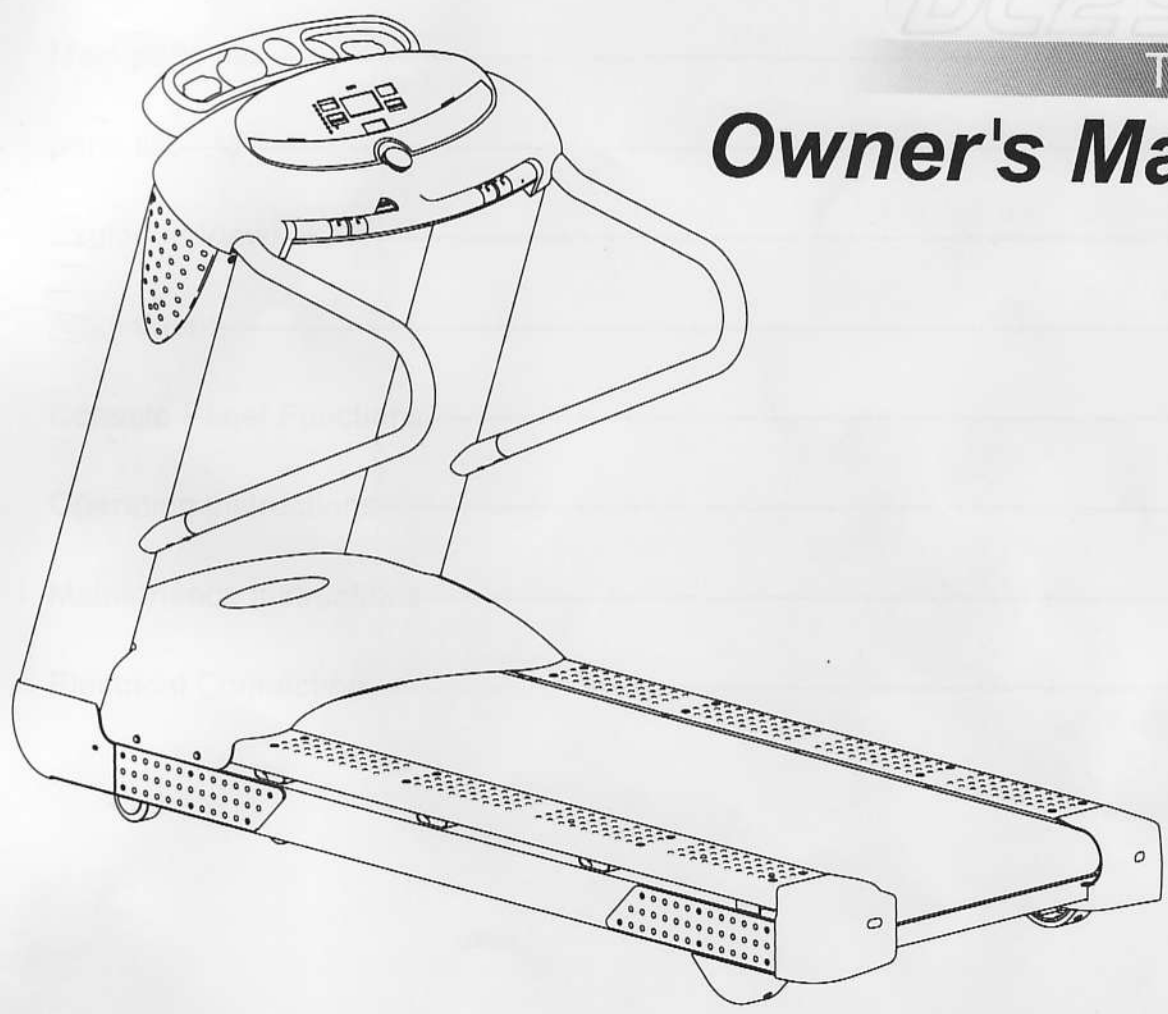

# Table Of Contents

---

Warning-----	1
Important Safety Instructions-----	2
Before you start-----	3
Grounding Instruction-----	4
Main parts list-----	5
parts list-----	6
Exploded View-----	8
Adjustment-----	10
Console Panel Functions-----	11
Operation instructions-----	15
Maintenance instructions-----	16
Electrical Connection-----	18

SAVE THESE INSTRUCTIONS

## Warning

---

Before using this treadmill or starting any exercise program, It is important to review this manual and the following precautions before operation.

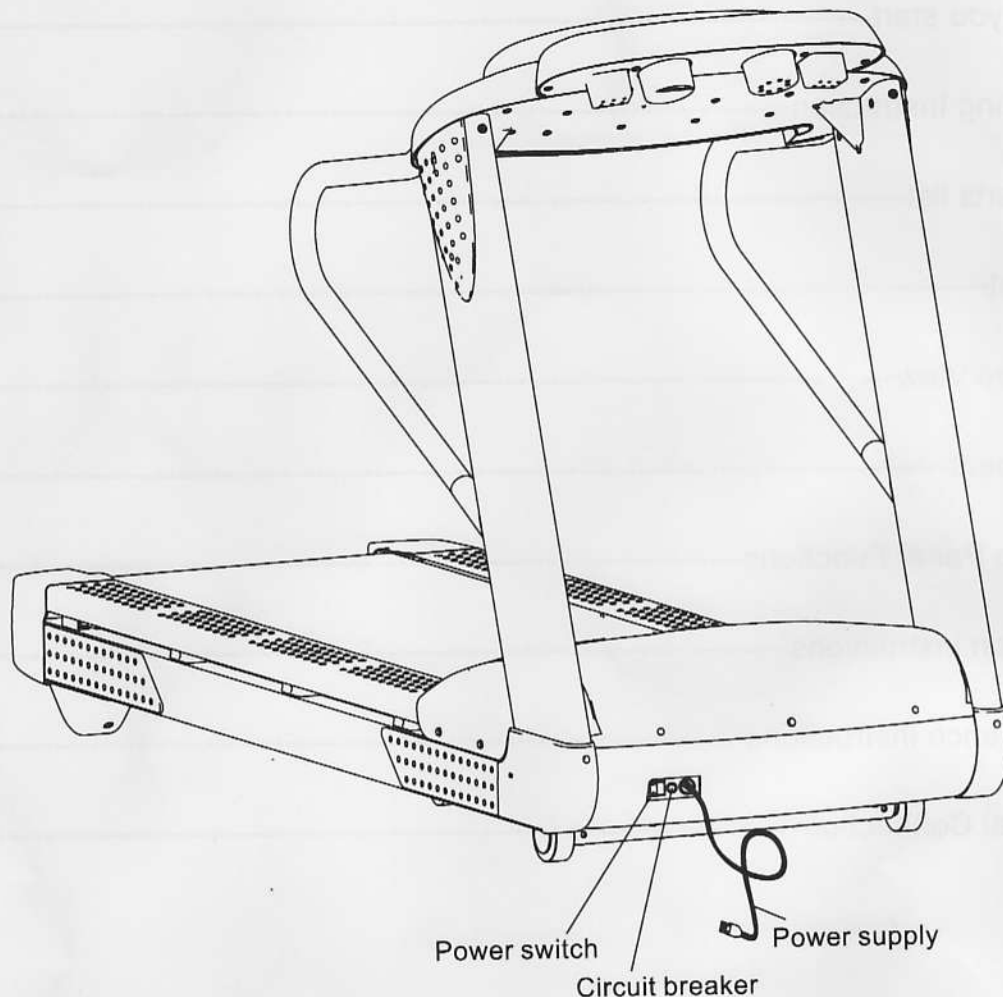

### Precautions:

1. Always unplug the treadmill after using to keep the life of treadmill and avoid any risk of injuries.
2. Power outlet over 20A must be used, and it must be properly earthed for not being shocked by electricity.
3. In order to protecting your treadmill, spattering water on the machine must be forbidden.

## **Important Safety Instructions**

---

When using an electrical appliance, basic precautions should always be followed, including the following:

Read all instructions before using this treadmill:

### **DANGER - To reduce the risk of electric shock:**

1. Always unplug this appliance from the electrical outlet immediately after using and before cleaning.
2. Do not reach for a treadmill that has fallen into water. Unplug immediately.
3. Do not use while bathing or in a shower.
4. Do not place or store the treadmill where it can fall or be pulled into a tub or sink. Do not place in or drop into water or other liquid.

### **WARNING - To reduce the risk of burns, fire, electric shock, or injury to persons:**

1. An appliance should never be left unattended when plugged in. Unplug from outlet when not in use, and before putting on or taking off parts.
2. Do not operate under blanket or pillow. Excessive heating can occur and cause fire, electric shock, or injury to persons.
3. Close supervision is necessary when this treadmill is used by, on, or near children, invalids, or disabled persons. Keep children away from extended back, foot support (or other similar parts).
4. Use this treadmill only for its intended use as described in this manual. Do not use attachments not recommended by the manufacturer.
5. Never operate this treadmill if it has a damaged cord or plug, if it is not working properly, if it has been dropped or damaged, or dropped into water. Return the treadmill to a service center for examination and repair.
6. Do not carry this treadmill by supply cord or use cord as a handle.
7. Keep the cord away from heated surfaces.
8. Never operate the treadmill with the air openings blocked. Keep the air openings free of lint, hair, and the like. Never operate on a soft surface such as a bed or couch where the air openings may be blocked.
9. Never drop or insert any object into any opening.
10. Do not use outdoors.
11. Do not operate where aerosol (spray) products are being used or where oxygen is being administered.
12. To disconnect, turn all controls to the off position, then remove plug from outlet.
13. Connect this treadmill to a properly grounded outlet only. See Grounding Instructions.
14. Risk of Injury to Persons –To Avoid Injury, Stand on the Siderails Before Starting Treadmill.

**SAVE THESE INSTRUCTIONS**

---

## **Before You Start**

---

**Remember to take the time to review owner's manuals before you start.**

1. Before using this treadmill or starting any exercise program, consult your physician and accompanied by specialized person. Adjust the speed not over 5MPH.
2. Take the time to perform the stretching exercise provided to avoid injury.
3. If you have heart problems, and/or the other diseases, do not use the treadmill programs without receiving approval form your physician.
4. Stop exercising or call physician if you feel uncomfortable.
5. Do not leave children unsupervised and disabled person near or on the treadmill.
6. Running is oxygen exercise, recommended 30 minutes per time is reasonable.
7. Wear comfortable, good-quality walking or running shoed and appropriate clothing.
8. Do not use the treadmill with bare feet, sandals, socks of stockings to avoid any risk of injuries. Wear comfortable shoes or cotton socks.
9. Failure to follow these instructions will void the treadmill warranty.
10. The equipment is designed for commercial and household, Maximum load is 170KG.

## **Grounding Instruction**

---

This product must be grounded. If it should malfunction or breakdown, grounding provides a path of least resistance for electric current to reduce the risk of electric shock. This product is equipped with a cord having an equipment-grounding conductor and a grounding plug. The plug must be plugged into an appropriate outlet that is properly installed and grounded in accordance with all local codes and ordinances.

**DANGER** - Improper connection of the equipment-grounding conductor can result in a risk of electric shock. Check with a qualified electrician or serviceman if you are in doubt as to whether the product is properly grounded. Do not modify the plug provided with the product - if it will not fit the outlet, have a proper outlet installed by a qualified electrician.

This product is rated more than 15 amperes and is for use on a circuit having a nominal rating of 120 volts and is factory-equipped with a specific electric cord and plug to permit connection to a proper electric circuit. Make sure that the product is connected to an outlet having the same configuration as the plug. No adapter should be used with this product. If the product must be reconnected for use on a different type of electric circuit, the reconnection should be made by qualified service personnel.

## Main parts list

It is the owner's responsibility to ensure that all users of this treadmill have read the Owner's Manuals before assembly.

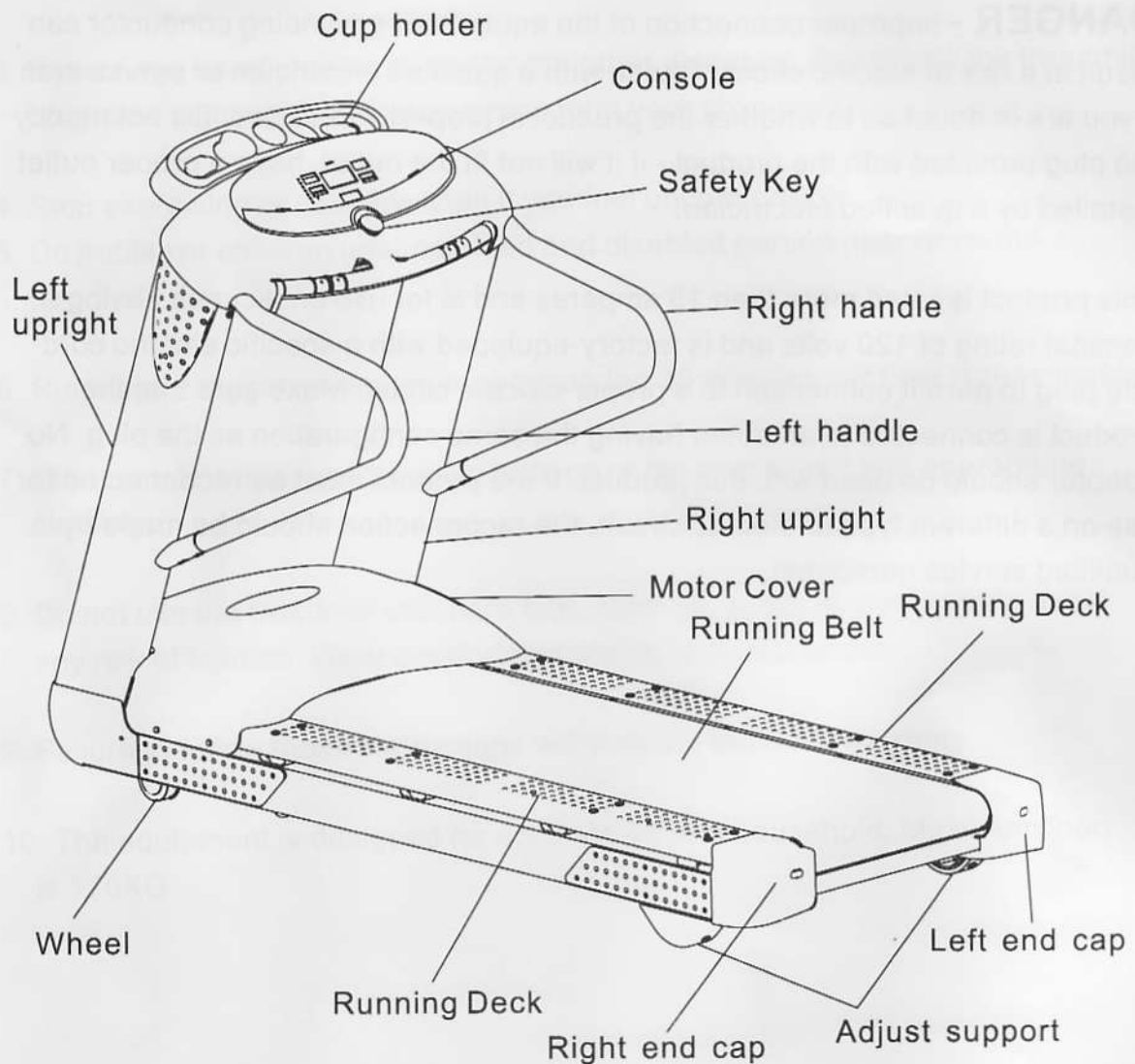

## Parts list

---

Item No.	Description	QTY	Item No.	Description	QTY
1	Console plate alliance	1	33	Left cover	1
2	Side handle	2	34	Right cover	1
4	Left upright	1	35	Left cover shield	1
5	Right upright	1	36	Right cover shield	1
6	Deck frame	1	37	Left end cap	1
7	Base frame	1	38	Right end cap	1
8	Controller shield	1	39	Left sheet	2
9	Left adjust support	1	40	Right sheet	2
10	Right adjust support	1	41	Bundle strap	4
11	Adjust plate	2	42	Bundle strap	4
12	Left extrusion	1	43	Bundle strap PLATE	4
13	Right extrusion	1	44	Grip sleeve	2
14	Left end cap support	1	45	Cord spacer	2
15	Right end cap support	1	46	Socket cap bolt M10*70	3
16	Rubber pad	8	47	Socket cap bolt M8*55	1
17	Walking board	1	48	Socket cap bolt M10*50	1
18	Front roller	1	49	Socket cap bolt M10*130	1
19	Rear roller	1	50	Hex bolt M12*55	2
21	decorate cover	4	51	Allen bolt M8*15	4
22	Wheel	2	52	Phillips head screw M6*12	4
23	Walking belt	1	53	Socket countersunk bolt M6*40	16
24	Poly V-belt	1	54	Socket countersunk bolt M8*20	22
25	Foam	2	55	Phillips countersunk screw M8*40	4
26	Adjust support cover	2	56	Phillips countersunk screw M3*10	2
27	Pillow block bearing	2	57	Phillips countersunk screw M6*12	2
28	Damper	2	58	Phillips head screw M5*10	3
28a	Damper A	10	59	Phillips head screw M6*12	20
29	Clip nut	6	60	Phillips head screw M6*30	5
30	Enchase Nut	16	61	Phillips head screw M3*8	1
31	Motor cover	1	62	Slotted pan head screw M5*10	1
32	Front cover	1	63	Phillips tapping screw ST1.9*6.5	2



## Parts list

---

Item No.	Description	QTY	Item No.	Description	QTY
64	Phillips tapping screw ST2.9*9.5	12	96	Extrusion bushing	16
65	Phillips tapping screw ST2.9*13	15	97	Phillips tapping screw	6
66	Phillips tapping screw ST4.2*13	3	98	Allen wrench 104*89*8	1
67	Phillips tapping screw ST4.2*16	45	99	Top handle	2
68	Phillips tapping screw ST4.2*16	35	100	Console assemble	1
69	Phillips countersunk tapping screw ST2.9*19	2	A1	A Cup holder	1
70	Phillips countersunk forming screw M4*12	6	A2	A Bottom handle	1
71	Washer	8	A3	A Console box	1
72	Washer	8	A4	A Safety gliding pole	1
73	Washer	4	A5	A PCB BRACKET	1
74	Washer	13	A6	A Safety key frame	1
75	Washer	5	A7	ASpring	1
76	Washer	5	A8	A Plastic washer	8
77	Washer	4	A9	A Safety key mount	1
78	Spring washer	4	A10	A Pulse receptacle plate	4
79	Spring washer	4	101	Console	1
80	Nylon nut	2	102	Emergency switch	1
81	Nylon nut	4	103	Controller	1
82	Hex nut	4	104	Console harness	1
83	Jam nut	4	105	Motor	1
84	Allen wrench	1	106	Jumper wire	2
85	Allen wrench	1	107	EKG Harness	2
86	Left junction box	1	108	EKG wire	1
87	Right junction box	1	109	Power switch	1
88	Washer	20	110	PCB membrane	1
89	Phillips countersunk screw	2	111	EKG module	1
90	Phillips countersunk screw	2	112	Chest receiver	1
91	Double-ended spanner	1	113	Chest pulse emitter	1
92	Upper plug	4	114	Actuator	1
93	Bottom plug	2	115	Power socket	1
94	Base bumper	4	116	Power cord	1
95	Phillips tapping screw	8			

# Exploded View

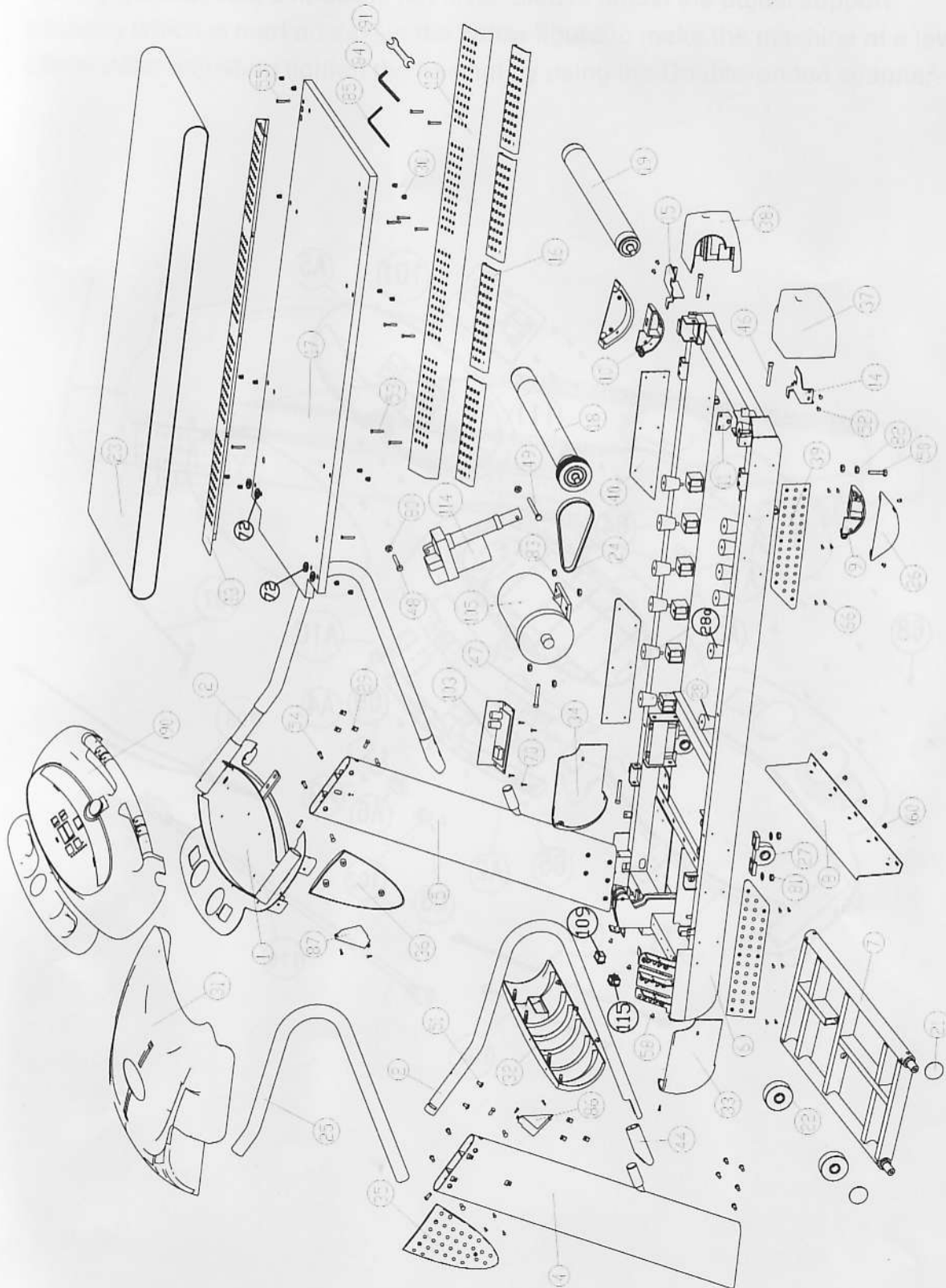

# Exploded View

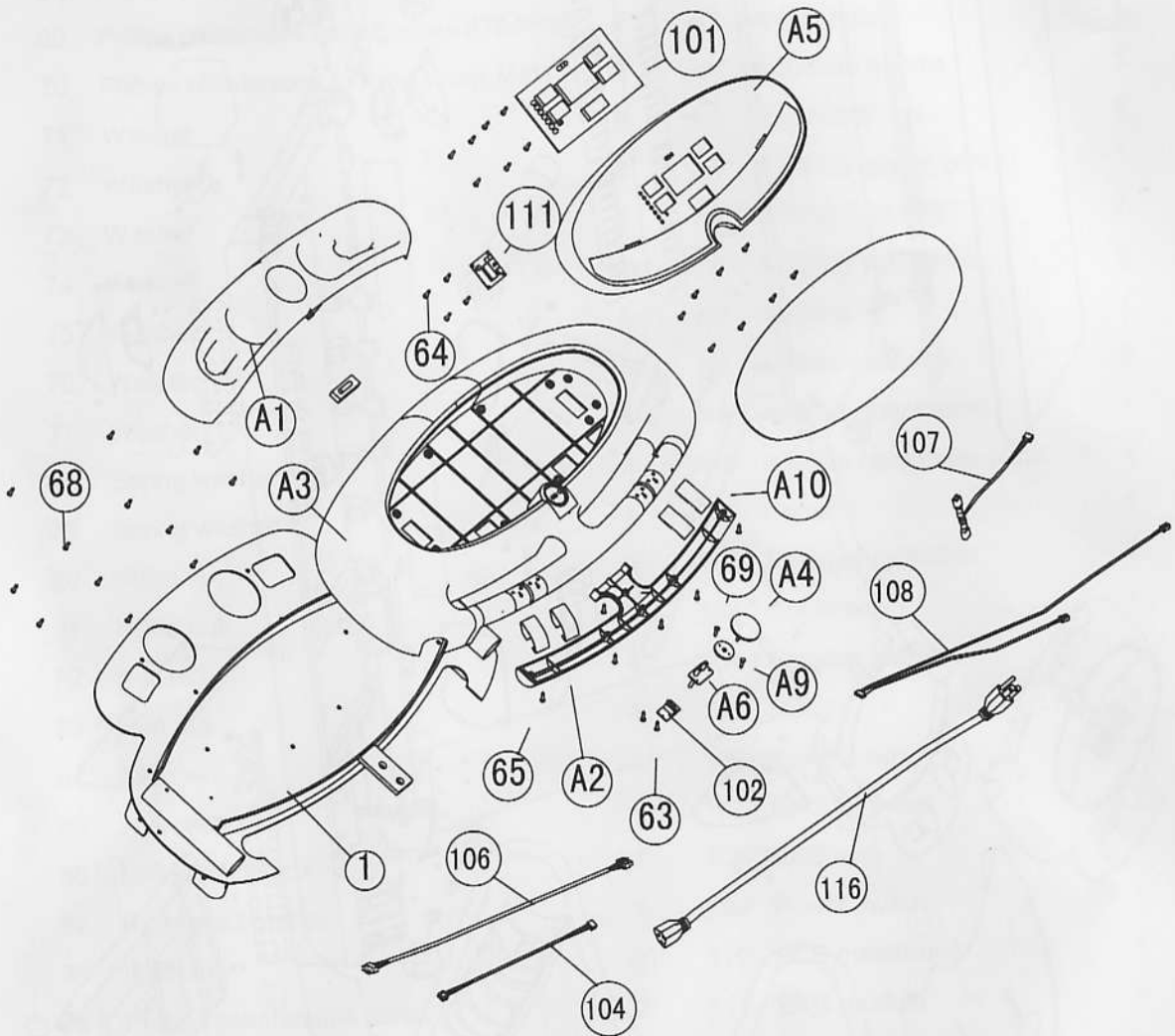

## Adjustment

---

If the ground in user's house is not level, please adjust the adjust support properly which is marked as A in the below figure to make the machine at a level place. After adjusting tighten the hex nut by using the Double-ended spanner.

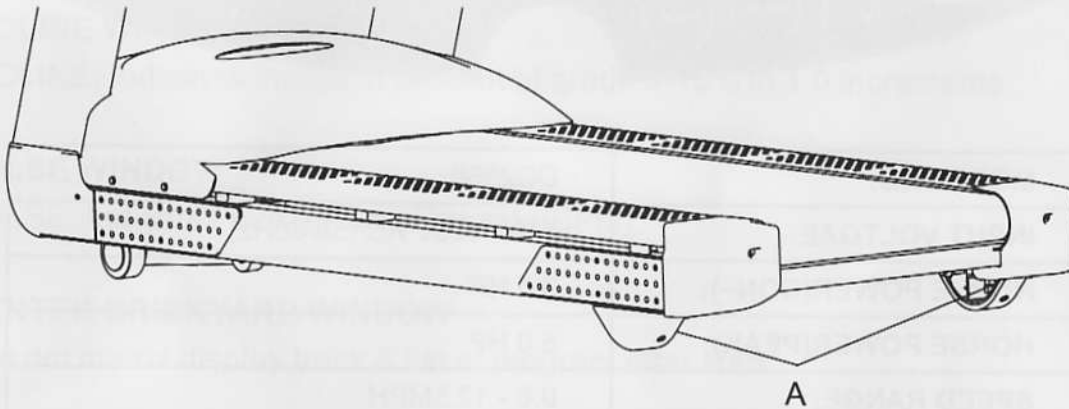

# Console Panel Functions

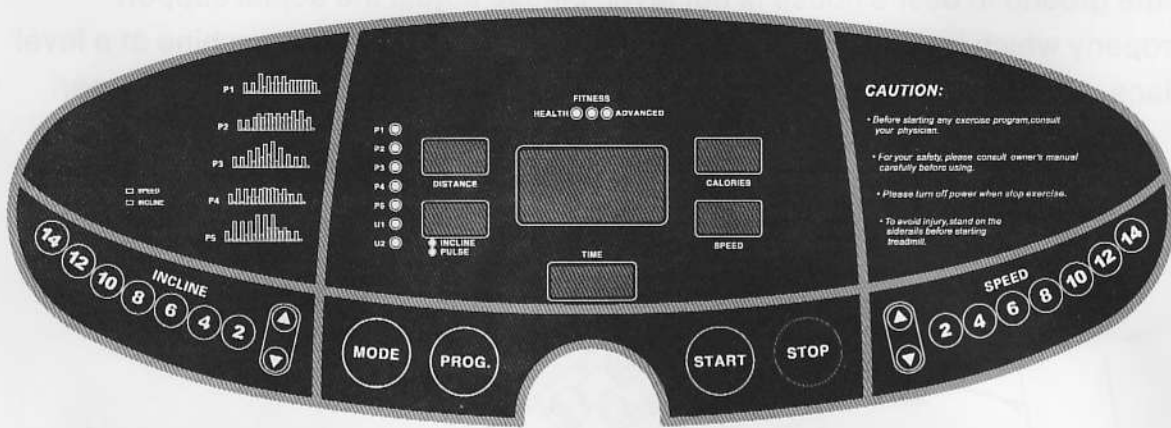

<b>MODEL NO:</b>	DC2950
<b>INPUT VOLTAGE:</b>	110 - 120V AC (50/60Hz)
<b>HORSE POWER(CON~):</b>	3.0 HP
<b>HORSE POWER(PEAK):</b>	5.0 HP
<b>SPEED RANGE:</b>	0.6 - 12.5MPH
<b>DISPLAY:</b>	Speed/Distance/Time/Calorie/ Pulse/Incline/Dot Matrix
<b>INCLINE RANGE:</b>	0 - 15%

## 1. CONSOLE PANEL FUNCTIONS

There are six display windows on the control panel to provide feedback information.

### TIME WINDOW

**TIME:** Indicates elapsed time after pressing start in minutes and seconds (0-99 minutes, 0-59 seconds).

**INTERVAL TIME:** Indicates countdown in seconds to the next interval starting at 5 seconds and counting to 0 seconds.

### SPEED WINDOW

**SPEED:** Indicates MPH (Mile per hour) in .1 increments.

# **Console Panel Functions**

---

## **DISTANCE WINDOW**

DISTANCE: Indicates Mile traveled in 0.1 increments up to 999 and 0.1 increments starting at 0.1.

## **CALORIES WINDOW**

CALORIES: Indicates estimated calories used based on 75Kg. person at the indicated speed, incline, and time.

## **INCLINE WINDOW**

INCLINE: Indicates incline in percent of grade 0-15% in 1.0 increments.

## **PULSE WINDOW**

PULSE: Indicates pulse your pulse rate(BPM).

## **CENTER BRICKYARD WINDOW**

The dot matrix display track & list of program after start.

## **2. BUTTON**

Speed+, Speed-; Incline+, Incline-; Start/Stop; Program; Mode;

Speed-one touch(2, 4, 6, 8, 10, 12);Incline-one touch(2, 4, 6, 8, 10, 12).

## **3.1. HOW TO TURN ON THE POWER**

Turn on the Power-switch on the front of treadmill.

## **3.2. HOW TO USE THE MANUAL MODE**

(1) The manual mode is defaulted when turned on the power.

(2) Press "mode - key" to select Time & Calories & Distance, Use speed+ & speed- keys to adjust parameter.

(3) Press "start - key".

(4) Then select speed & incline.

## **3.3. HOW TO USE Preset1 - Preset5 MODE**

Press "Program - key" to select Preset1 - Preset5 mode when turned on Power then press "start-key" to run. Notice From preset1 to preset5 be don't adjust.

## **Console Panel Functions**

---

### **3.4. HOW TO USE Customer1 - Customer2 MODE**

Press "Program - key" to select Customer1 - Customer2 mode when turned on power then press "start - key" to run. From Customer1 to Customer2 be to adjust. Use MODEL - key to select 10 parts of Customer program, Use speed+ & speed- keys to adjust level of Speed & Incline.

### **3.5. HOW TO USE HR Rate MODE**

The console offers three heart rate programs: HR1 Rate\HR2 Rate\HR3 Rate programs. Each program will automatically control the speed and incline of the treadmill to keep your heart rate within targeted heart rate zone. Follow the steps below to use a heart rate program.

***PUT ON THE CHEST HEART RATE SENSOR.***

***YOU MUST WEAR THE CHEST PULSE SENSOR TO USE A HEART RATE PROGRAM.***

As the program progresses, the speed and incline of the treadmill will change periodically to keep your heart rate near predetermined settings, shown by the graphs on the left side of the console.

### **3.6. CALIBRATION MODE**

Calibration mode is entered by pressing SPEED+ & SPEED- AND INCLINE+ & INCLINE- keys. The treadmill auto. to calibrate incline range.

### **3.7. ERROR CODES**

- (1) E-01: Console no receive feedback pulse from controller after 30s when start
- (2) E-03: Please check 'safe - key"
- (3) E-04: Over current
- (4) E-05: Over voltage
- (5) E-06: Over load
- (6) E-07: Controller no receive feedback pulse from Console

## Console Panel Functions

---

Trouble phenomena	Reason and troubleshooting guide
Treadmill will not start	1. Make sure the power cord plugged into a properly grounded outlet.
	2. Check the main switch located on the front of the treadmill. If the switch is off, turn it on.
	3. Have an electrician check to ensure there is adequate voltage at the outlet.
Treadmill loses power during use	Check the main switch located on the front of the treadmill. If the switch is off, turn it on.
Treadmill walking belt slows during use	Check to make sure the treadmill is securely plugged into a properly grounded outlet rated at 20 amps, with a 14-gauge cord of five feet or less.



## **Operation Instructions**

---

**Please read carefully and using follow the functions:**

1. Reset the emergency switch.
2. put the plug in the socket, turn on the on-off.
3. grasp the handle firmly, stand on the treadle.
4. You can operate this device according with the manual. At first you should set the lowest speed, then increase the speed gradually.
5. you should grasp the handle firmly by one of your hands, when you operating the console.
6. Take care to use treadmill. Start from low speed handed to the Uprights Leaving from treadmill after reducing speed and stopping all functions.
7. Press the emergency switch in an emergency, then the power and motor will turn off at once.
8. Warm and relax your body after workout.

Exercise time and exercise frequency at a time:

Exercise time: 30minuates----Normal;

Exercise frequency: Warm your body by 10---20minutes under 5MPH Then increase speed accordingly.

# Maintenance Instructions

## 1. Belt Adjustment:

### (1) Belt adjustment and tension performs two functions:

The distance between belt and motor cover from left to right within +/-5MM, then needed to be adjusted.

Adjust belt by speed not more than 2.5MPH.

### Normal position of belt as below:

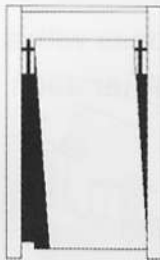
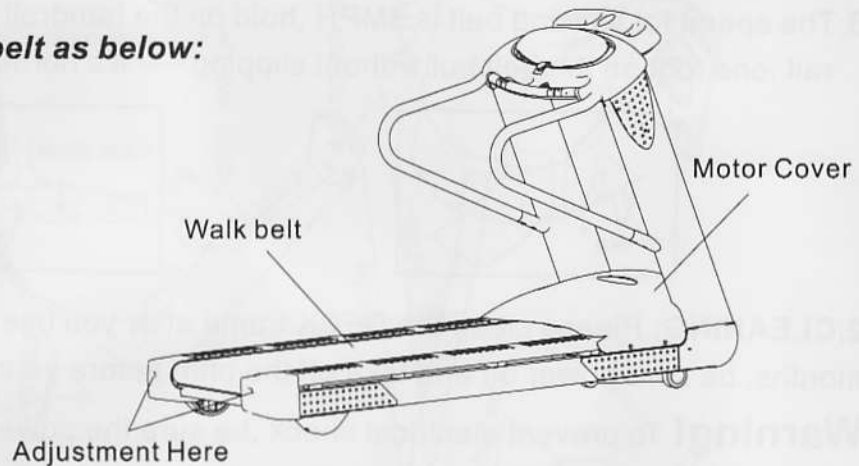
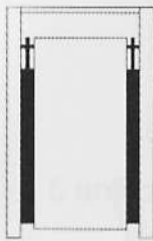

### A. Walking Belt is shifting to the right:

Using hex key provided, turn the right rear roller adjustment bolt turn in the clockwise direction shown as below or on the contrary direction.

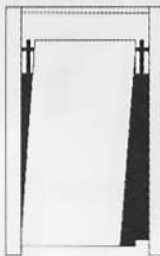

### B. Walking Belt is shifting to the left:

Using hex key provided, turn the right rear roller adjustment bolt turn in the clockwise direction shown as below or on the contrary direction.

### (2) Walking belt is Slipping during use:

Slight walking belt slipping is on normal while using for a period Using the hex key provided, turn both left and right rear roller adjustment bolts in the same distance.

# Maintenance Instructions

See the correct walking belt shown as below:

A. The distance between walking belt and board is within

15-20mm ---- Normal

Over 20mm ---- needed to be adjusted

Under 15mm ---- needed to be adjusted

B. The speed for walking belt is 3MPH ,hold on the handrail ,stand on the side rail ,one foot on the belt but without slipping ---- it's normal.

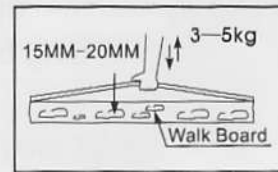
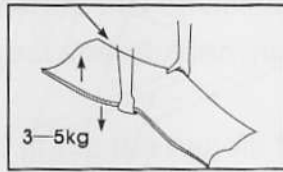

**2.CLEANING:** Please clean the DECK frame after you use the machine 3 months, be sure power off and take off the plug before your cleaning.

**Warning!** To prevent electrical shock ,be sure the power to the treadmill is OFF and the unit is unplugged from the wall electrical outlet before attempting any cleaning or maintenance.

After Each Workout: Wipe off the console and other treadmill surfaces with a clean, water dampened soft cloth to remove excess perspiration. After each workout.

## USE NO CHEMICALS

Weekly: Use of a treadmill mat is recommended for ease of cleaning.

Vacuum underneath treadmill once a week.

Opening motor cover is forbidden commonly. If the electricity board or motor is needed to be cleaned, call qualified service personnel.

## 3.LUBRICATION:

It is recommended that the walking board be checked periodically (around 3 months) for lubrication to ensure optimal treadmill performance.

Using hex to lift the belt and insert the silicone about 20 gram to spray smoothly (adjust belt without slipping after lubrication).

4. Any other servicing should be performed by an authorized service representative.

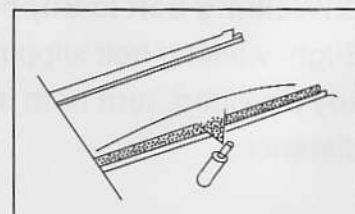

# Electrical Connection

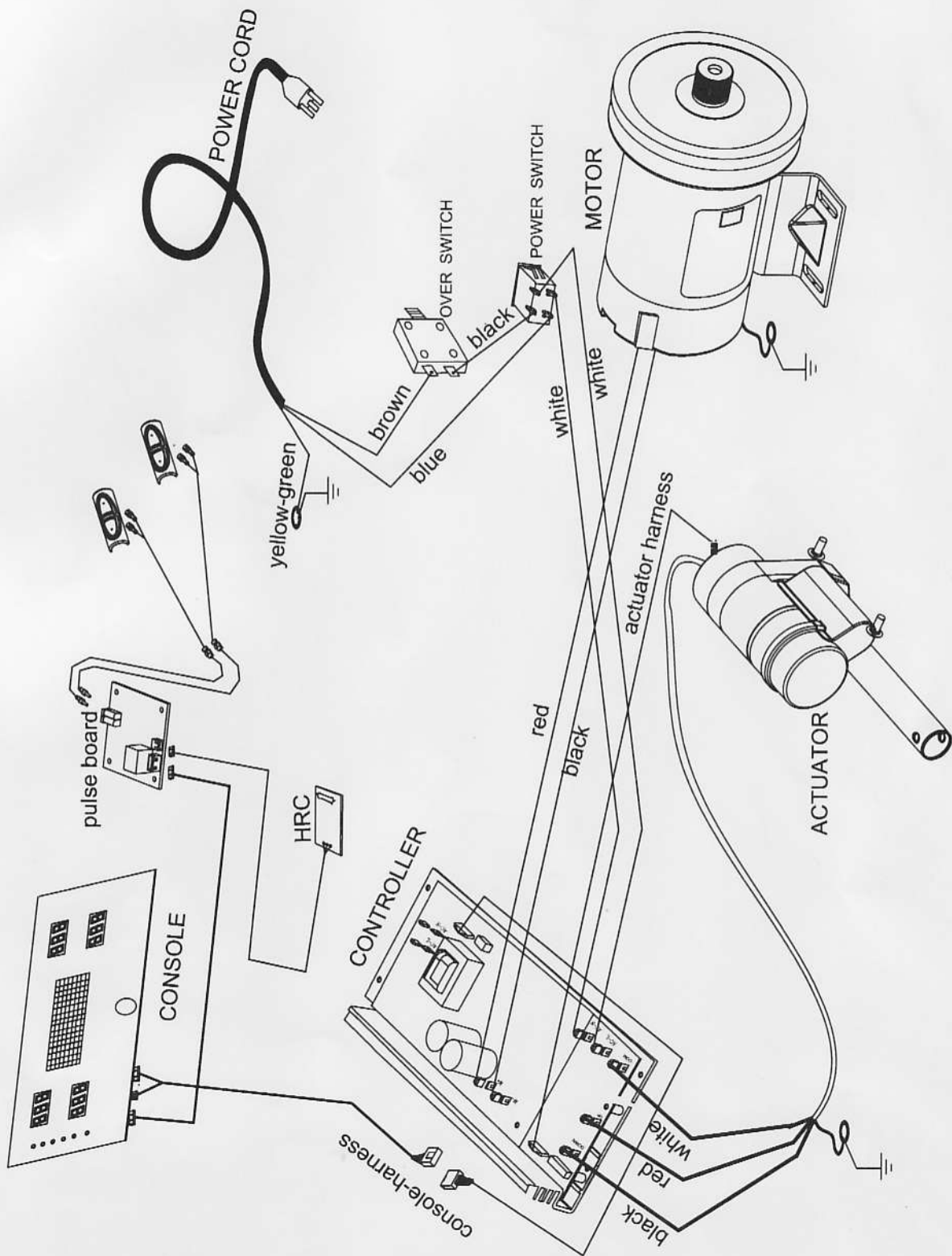

## Free Manuals Download Website

<http://myh66.com>

<http://usermanuals.us>

<http://www.somanuals.com>

<http://www.4manuals.cc>

<http://www.manual-lib.com>

<http://www.404manual.com>

<http://www.luxmanual.com>

<http://aubethermostatmanual.com>

Golf course search by state

<http://golfingnear.com>

Email search by domain

<http://emailbydomain.com>

Auto manuals search

<http://auto.somanuals.com>

TV manuals search

<http://tv.somanuals.com>