

Nikon

Autofocus Speedlight

SB-27

Instruction Manual

En

CE

Foreword

Thank you for purchasing the Nikon Autofocus Speedlight SB-27, an easy-to-use flash unit offering you the most convenient system for automatic flash photography in combination with Nikon cameras. The SB-27's extensive capabilities range from Non-TTL Auto Flash to 3D Multi-Sensor Balanced Fill-Flash, today's most advanced flash technology.

For optimum results, be sure to read this manual thoroughly before use.

Please check which group your camera belongs to.

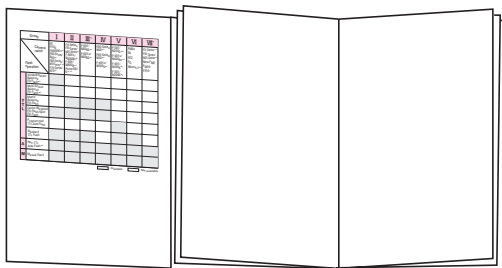

In this manual, we have divided Nikon SLR cameras into seven groups (from I to VII) unless otherwise noted. You will find all the information you need to learn about using the SB-27 with your camera in the section corresponding to your camera group. Please refer to the camera group table on the following page.

Camera groups

Group	I	II	III ^{*1}	IV	V	VI	VII [*]
Camera name	F5 F100 F90X/N90s ^{*1} F90-Series/ N90 ^{*1} F80-Series/ N80-Series ^{*1, *3} F70-Series/ N70 ^{*1}	F4-Series F65-Series/ N65-Series ^{*1} F-801s/ N8008s ^{*1} F-801/ N8008 ^{*1} Pronea 600i/ 6i ^{*1, *3}	F-601/ N6006 ^{*1} F-601M/ N6000 ^{*1}	F60-Series/ N60 ^{*1} F50-Series/ N50 ^{*1} F-401x/ N5005 ^{*1}	F-501/ N2020 ^{*8} F-401s/ N4004s ^{*1} F-401/ N4004 ^{*1} F-301/ N2000 ^{*8}	FM3A FA FE2 FG Nikonos V ^{*5}	F3-Series ^{*6} F55-Series/ N55-Series ^{*1} New FM2 FM10 FE10
Flash operation	3D Multi-Sensor Balanced Fill-Flash ^{*2}						
	Multi-Sensor Balanced Fill-Flash ^{*2}						
	Matrix Balanced Fill-Flash						
	Center-Weighted Fill-Flash/Spot Fill-Flash						
	Programmed TTL Auto Flash						
	Standard TTL Flash						
A Non-TTL Auto Flash ^{*7}							
M Manual Flash							

 : Available  : Not available

*1 Sold exclusively in the USA.

*2 3D Multi-Sensor Balanced Fill-Flash and Multi-Sensor Balanced Fill-Flash are generally referred to as Automatic Balanced Fill-Flash with TTL Multi Sensor.

*3 Center-Weighted Fill-Flash/Spot Fill-Flash is not possible.

*4 Some flash functions are controlled on camera.

*5 An optional sync cord for land use is required.

*6 Optional flash Unit coupler AS-4 or AS-7 is required. With AS-17, Standard TTL flash is possible, but not Repeating flash.

*7 See page 69 for cameras in groups I through VI, and page 38 for cameras in group VII.

*8 Sold exclusively in the USA and Canada.

*For cameras such as the Nikon F or Nikon F2, refer to Group VII.

NOTE: For details on the SB-27's available TTL Auto Flash operations, see the separate Quick Reference sheet and the Glossary of terms on pages 83 to 88.

Download from www.Sdmanuals.com. All Manuals Search And Download.

About this manual

The instruction materials comprise the main manual and a separate Quick Reference sheet.

- In the main manual, we begin with instructions on preparing the Speedlight for shooting and move on to a variety of basic and advanced flash photographic techniques covering all available functions.
- In the separate Quick Reference sheet, we explain some basic flash photographic procedures.
- Nikkor lenses have been roughly divided into two types as shown below unless otherwise noted.

Nikkor lenses with built-in CPU	<ul style="list-style-type: none">• D- or G-type Nikkor lenses• IX Nikkor lenses**• Non-D/G-type AF Nikkor lenses* AI-P-type Nikkor lenses
Nikkor lenses without built-in CPU	<ul style="list-style-type: none">• AI-S-type or AI-type Nikkor lenses• Nikon Series E lenses• AI-modified Nikkor lenses and others

* Except AF Nikkor lenses for F3AF

** IX Nikkor lenses are designed for use with the Nikon Advanced Photo System (IX240) format SLR camera body only and cannot be used with 35mm SLR cameras.

Notices used in this manual



Denotes important points where caution or mandatory action is required.

NOTE Denotes a useful point that should be remembered for future reference.

Tips on using the Speedlight

■ Take some trial shots.

Before taking important flash photographs, take a few trial shots first to make sure the Speedlight is working properly.

■ Use only Nikon-approved equipment.

Your Speedlight has been designed for use in combination with Nikon cameras, lenses and accessories.

—Using cameras or accessories other than those specified by Nikon may damage your Speedlight.

—Nikon cannot be held responsible for malfunctions caused by using the SB-27 in ways not specified in this manual, or using the SB-27 with a camera made by another manufacturer.

■ For further details on camera operation, read the instruction manual provided with each camera before use.



Take special care when detaching the SB-27 from your camera.

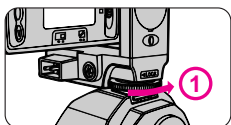

For cameras with a safety lock system: loosen the mounting foot locking wheel all the way in the direction of arrow ①, and slowly detach the SB-27.

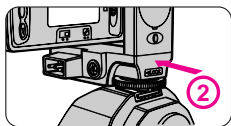

If the mounting foot locking wheel doesn't loosen easily, do not force it. Push the foot forward gently once in the direction of arrow ② and try loosening the wheel again.

Contents

Foreword	2
Camera groups	3
About this manual	4
Tips on using the Speedlight	5
Contents	6-7
Speedlight parts	8
LCD panel indications	9

Preparations for taking flash photographs	10
Installing batteries	11
Standby function	12-13
Attaching the SB-27 to the camera	14
Adjusting the flash head	15
Selecting a measurement system (meters/feet)	16
The ready-light	17
Test firing with the open-flash button	18
Setting ISO film speed	19
Setting zoom-head position	20-21

Basic flash operation	22
Selecting a flash mode	23
Flash operation in AUTO mode (Cameras in Group I: F5, F100, F90X/N90s, F90-Series/N90, F80-Series/N80-Series, F70-Series/N70)	24-25
Flash operation in AUTO mode (Cameras in Group II: F4-Series, F65-Series/N65-Series, F-801s/N8008s, F-801/N8008, Pronea 600i/6i)	26-27
Flash operation in AUTO mode (Cameras in Group III: F-601/N6006, F-601M/N6000)	28-29
Flash operation in AUTO mode (Cameras in Group IV: F60-Series/N60, F50-Series/N50, F-401x/N5005)	30-31
Flash operation in AUTO mode (Cameras in Group V: F-501/N2020, F-301/N2000)	32-33
Flash operation in AUTO mode (Cameras in Group V: F-401s/N4004s, F-401/N4004)	34-35
Flash operation in AUTO mode (Cameras in Group VI: FM3A, FA, FE2, FG, Nikonos V)	36-37
Flash operation in AUTO mode (Cameras in Group VII: F3-Series, F55-Series/N55-Series, New FM2, FM10, FE10) ..	38-39
If the ready-light blinks after shooting	40

Advanced flash operation	41
Flash operation in Manual (M) mode	42-45

Guide numbers for determining correct aperture	46
Autofocus flash operation in dim light (For AF SLR cameras only)	47-48
Bounce flash operation (For cameras in all Groups)	49-53
Procedures for bounce flash operation	51-52
Highlight your subject's eyes with bounced flash	53
Close-up flash operation in AUTO mode (Cameras in Groups I thru VI)	54-59
Procedures	54
Close-up flash operation using an TTL Remote Cord	59
Exposure compensation for flash photography (Cameras in Groups I thru III)	60-62
Cameras in Groups I and II	61
Setting exposure compensation on the SB-27	61
Canceling exposure compensation	62
Cameras in Group III	62
Multiple flash operation—using more than one Speedlight (Applicable to all camera groups)	63-68
TTL multiple flash operation procedures	64
System chart for TTL multiple flash	66-67
Manual multiple flash operation procedures	68
Setting Forced TTL and Forced A modes (Applicable to all camera groups)	69-70
Setting and canceling Forced TTL and Forced A modes	69
Forced TTL mode	69
Forced A mode	70
Canceling Forced TTL and Forced A modes	70
Red-eye reduction control (For cameras in Group I [except F5] and Pronea 600i/6i)	71
Other information	72
Using an external power source	73
Connecting the SB-27 to a camera with a sync cord	74
Warning indications on the camera	75
Troubleshooting	76
Optional accessories	77-78
Tips on Speedlight care	79-80
Notes on batteries	81-82
About NiCd batteries	82
Using the SB-27 in low temperatures	82
Glossary of terms	83-88
Specifications	89-91



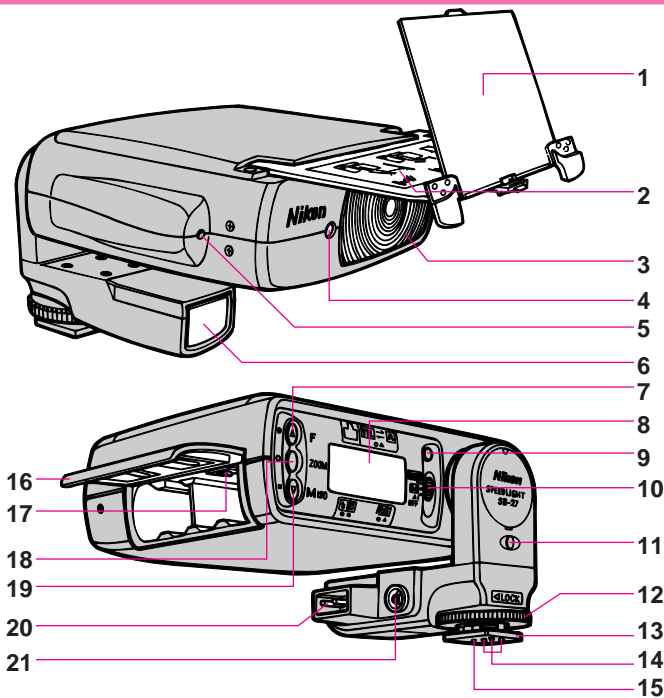

Speedlight parts

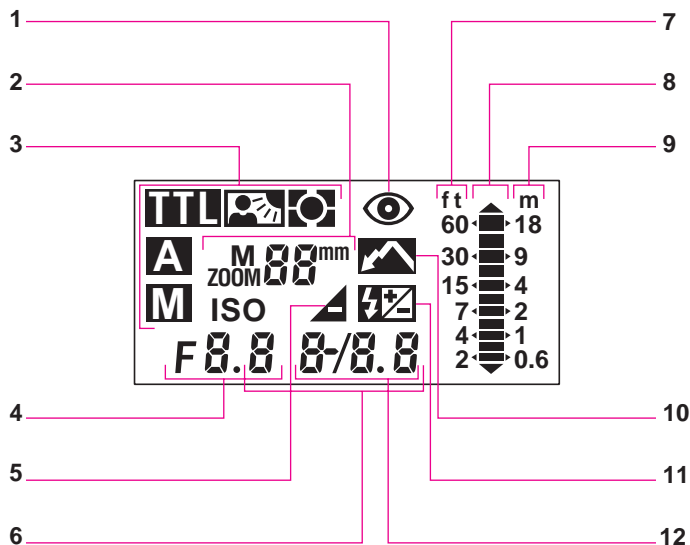

- | | |
|---|---|
| 1 Built-in diffuser card (See page 53.) | 11 Open-flash button (See page 18.) |
| 2 Built-in bounce flash adapter (See page 52.) | 12 Mounting foot locking wheel (See page 14.) |
| 3 Flash head (See page 15.) | 13 Mounting foot (See page 14.) |
| 4 Red-eye reduction lamp | 14 Hot-shoe contacts (See page 14.) |
| 5 Light sensor for Non-TTL Auto Flash operation | 15 Mount pin (See page 14.) |
| 6 AF assist illuminator LED (See page 47.) | 16 Battery chamber lid (See page 11.) |
| 7 "F" button (See pages 16, 25, 27, 29, 31, 33, 35, 37, 39 and 61.) | 17 Camera setting switch (See pages 12, 69) |
| 8 LCD panel (See page 9.) | 18 "ZOOM" button (See page 20.) |
| 9 Ready-light (See page 17.) | 19 "M" (M/ISO) button (See pages 20, 23, 24, 26, 43 and 61./See page 19.) |
| 10 Flash mode selector (OFF / M / AUTO) (See page 18.) | 20 External power source terminal (See page 73.) |
| | 21 Sync terminal (See page 74.) |

LCD panel indications



- | | |
|--|---|
| <p>1 Red-eye reduction control indicator</p> <p>2 Zoom-head position indicator</p> <p>3 Flash mode indicator</p> <p>  Automatic Balanced Fill-Flash with TTL Multi Sensor
  Matrix Balanced Fill-Flash
  Standard TTL Flash
  Non-TTL Auto Flash
  Manual Flash </p> <p>4 Aperture indicator</p> | <p>5 Underexposure indicator</p> <p>6 Film speed indicator</p> <p>7 Flash shooting distance scale (ft.)</p> <p>8 Indicator bars (flash shooting distance indicator bars)</p> <p>9 Flash shooting distance scale (m)</p> <p>10 Bounce flash indicator</p> <p>11 Exposure compensation indicator</p> <p>12 Light output/exposure compensation value indicator</p> |
|--|---|

- LCDs are temperature sensitive, and may turn black at high temperatures [approx. 40°C (104°F) or above] and become hard to read.
- In cold temperatures [approx. 5°C (41°F) or below], the LCD's response time slows down. These reactions are typical of LCDs and not cause for concern. In both cases, LCDs will function perfectly again once the temperature returns to normal [20°C (68°F)].

Preparations for taking flash photographs

Installing batteries

Four penlight batteries (1.5V or lower) of any of the following types may be used:



- AA-type alkaline-manganese (1.5V)
- AA-type lithium (1.5V)
- AA-type NiCd (rechargeable) (1.2V)
- AA-type Ni-MH (Nickel Metal Hydride) (rechargeable) (1.2V)

Note: High powered manganese batteries are not recommended for use with this Speedlight.

See page 81 for "Notes on batteries."

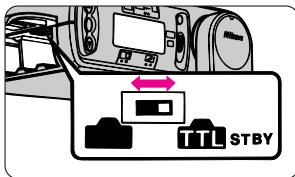
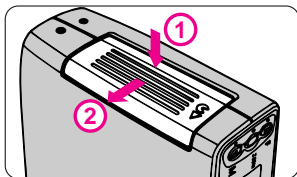
- 1 Open the battery chamber lid, and set the camera setting switch.



With cameras in Groups I thru VI, be sure to set the camera setting switch to , and set it to  for cameras in Group VII.

See pages 12, 69 on camera setting switch.

- 2 Install four penlight batteries and close the battery chamber lid.

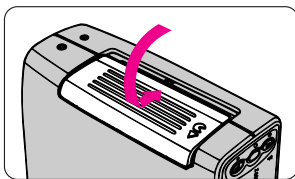
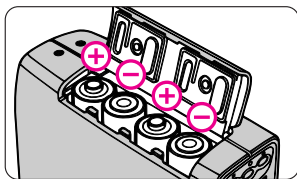

Do not mix battery brands or types, or new and old batteries.

NOTE

Replace the batteries within 30 seconds after turning OFF the power of the SB-27 to preserve data settings.

Standby function

(Applicable to all camera groups)

When both the SB-27 and the camera are not in use, the SB-27's power automatically shuts OFF after approx. 80 seconds in order to conserve battery power. (Standby function)

Setting the standby function

■ Cameras in Groups I thru VI (featuring TTL Auto Flash)

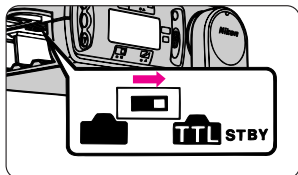

Set the camera setting switch (inside the SB-27's battery chamber) to STBY.

—If it is set to , the standby function will not work.

To turn the SB-27's power ON again

Lightly press the shutter release button to turn the power ON.

—Pressing the open-flash button also turns the SB-27's power ON. In this case, the flash does not fire. (See page 18.)

Standby function will not work when:

- Shutter speed is set at M250 or B (Bulb) (for FA and FE2)
- Shutter speed is set at M90 or B (Bulb) (for FG and Nikonos V).
- Shutter speed is set at B (bulb) (for FM3A).



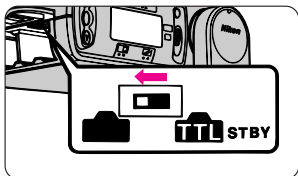

When your SB-27 is not in use or if you carry it in a bag, we recommend setting the flash mode selector to OFF to avoid turning the power ON accidentally.

■ Cameras in Group VII (without TTL Auto Flash)





As the standby function is not available, be sure to set the camera setting switch (inside the SB-27's battery chamber) to .



NOTE

If you use the SB-27 with two cameras (one featuring TTL Auto Flash and the other without TTL Auto Flash), we recommend setting the camera setting switch to  so that the flash mode automatically switches to  mode with the camera featuring TTL Auto Flash, and to  mode with the camera without TTL Auto Flash capability.

—Be sure to turn the SB-27's power OFF when the camera setting switch is set to  as the standby function will not work.

For F50-Series/N50, F-601/N6006, and F-601M/N6000

If camera power shuts OFF with the camera setting switch (inside the SB-27's battery chamber) set to , the  indicator in the LCD panel changes to . This is no cause for concern.

If the SB-27's flash mode selector is set to "AUTO", the  indicator in the LCD panel changes to  enabling TTL Auto Flash operation.

Attaching the SB-27 to the camera

When attaching the SB-27, make sure both the Speedlight and the camera are turned OFF to avoid accidental firing.

- 1 Loosen the SB-27's mounting foot locking wheel.

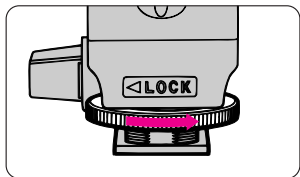

—A squeaky sound can be heard when loosening the mounting foot locking wheel. This is no cause for concern.

- 2 Attach the SB-27 to the camera accessory shoe and tighten the locking wheel.

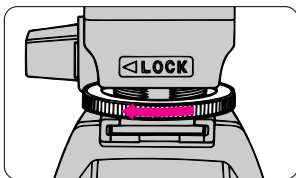
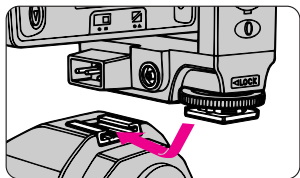

NOTE

Loosen the mounting foot locking wheel all the way to detach the SB-27.

With cameras equipped with a safety lock system, the mount pin is automatically inserted into the locking hole in the camera's accessory shoe to secure the SB-27. To detach the SB-27, loosen the mounting foot locking wheel all the way. (See page 9.)

Adjusting the flash head

The flash head rotates from the horizontal to the vertical position along a 180° arc. From the horizontal position, simply tilt the flash head up 90° until it clicks into position.

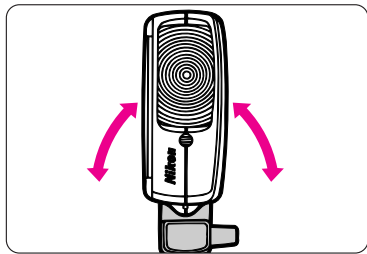
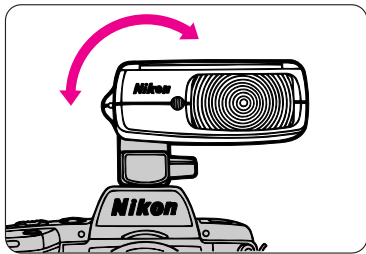

Keep the flash head in the horizontal position for normal flash shooting.

- When the flash head is set to the left as viewed by the photographer, a shadow falls to the right of the subject, and if the flash head is set to the right, the shadow falls to the left.
 - When the flash head is set in the vertical position, the shadow appears under the subject's chin or just behind the subject, as the flash illuminates the subject from the top.
- This flash-head adjustment capability makes multi-directional bounce flash operation possible. (See page 49.)

Selecting a measurement system (meters/feet)

Set the flash shooting distance measurement system in the LCD panel to either meters (m) or feet (ft).

—The system is preset to meters (m) when shipped from the factory.

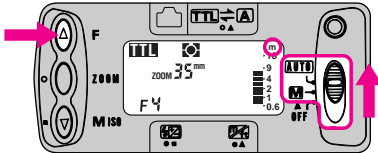

Set the flash mode selector from “OFF” to “M” or “AUTO” while holding down the “F” button and select the desired indication (m or ft).

—If you replace the batteries with the SB-27's power ON, the measurement system returns to the default meters (m) system, even if feet (ft) had been previously set.

The ready-light

The ready-light comes ON when charging is completed.

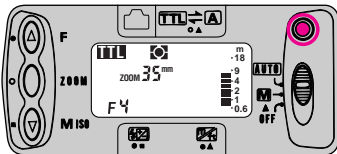

When the SB-27 is fully charged and ready to fire, the ready-light comes ON. Be sure to check that the ready-light is ON when releasing the shutter.

The ready-light blinks when flash fires at its maximum output.

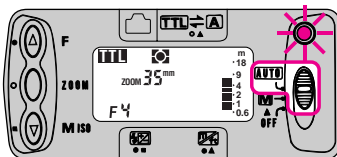

In AUTO mode, if the ready-light blinks for approx. 3 seconds after shooting, it means that the flash has fired at its maximum output but the light may have been insufficient. (See page 40.)

—In that case, reconfirm the flash shooting distance range, aperture and flash-to-subject distance, and if necessary, use a wider aperture or move closer to the subject and then reshoot.



Replace batteries with a fresh set.

- Replace alkaline-manganese batteries (or lithium batteries) if the ready-light takes more than 30 seconds to light up.
- Recharge NiCd batteries if the ready-light takes more than 10 seconds to light up.

Test firing with the open-flash button

- 1 Set the flash mode selector to “M” or “AUTO”.

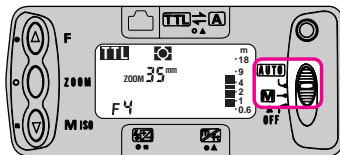

The ready-light comes ON when the SB-27 is ready to fire.

- 2 Check if the ready-light is ON and press the open-flash button to ensure that the SB-27 is firing properly.

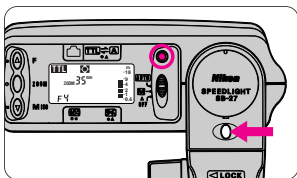

When battery power becomes weak, the ready-light takes longer to come ON or the power may automatically shut OFF .

NOTE

Pressing the open-flash button also turns ON the SB-27 after it has been turned OFF by the standby function. (See page 12.)
—In this case, the flash will not fire. Press the open-flash button once more to resume normal test firing.

Setting ISO film speed

The following ISO film speeds can be used in AUTO mode:

- ISO 25 to ISO 1000 for cameras in Groups I thru IV, and F-501/N2020, F-301/N2000 cameras.
- ISO 25 to ISO 400 for cameras in Groups VI and VII, and F-401s/N4004s and F-401/N4004 cameras.

With cameras in Groups I and II

ISO film speed is set automatically, but does not appear in the LCD panel.

—Manual ISO film speed setting is not possible.

With cameras in Groups III thru VII

Set the ISO film speed manually as follows:

1

Press the “M” button to see the film speed indicator in the LCD panel.

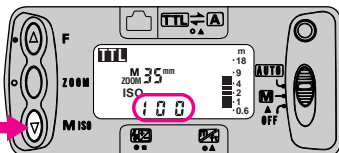

2

Set the ISO film speed of the film loaded.

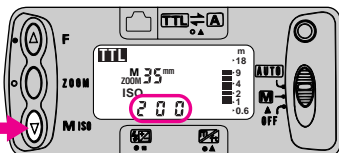

Press the “M” button to advance the film speed setting. To speed up the advance, keep pressing the button.

—Stop when the ISO speed of the film in use is displayed in the LCD panel.

Setting zoom-head position

In the horizontal position, the SB-27 has four zoom-head position settings: 24mm, 28mm, 35mm and 50mm.

Three zoom-head position settings are available in the vertical position: 35mm, 50mm and 70mm.

—All the above stops are indicated in the LCD panel.

—Zoom-head positioning differs depending on the camera/lens combination.

Cameras in Groups I and II with Nikkor lenses with built-in CPU

The SB-27 automatically adjusts the zoom-head position to provide an angle of coverage that matches the focal length of the lens in use. (Automatic zoom-head positioning)

① Automatic zoom-head positioning is activated.

② Automatic zoom-head positioning is canceled.

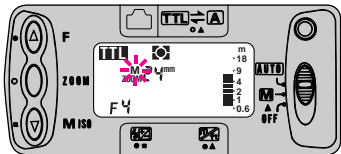
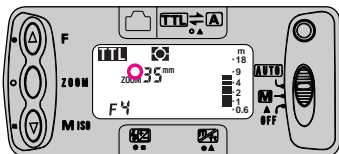

—When using a Nikkor lens with built-in CPU whose focal length is below or above the SB-27's available range, the zoom-head automatically adjusts to the closest focal length setting.

Note: Automatic zoom-head positioning is not possible if a small M appears above the ZOOM. Press the “ZOOM” button several times until the M disappears ①.

NOTE

To cancel automatic zoom-head positioning and set the position manually:

- (1) Press the “ZOOM” and “M” buttons simultaneously for approx. 2 sec. until the small M above the ZOOM starts to blink ②. Automatic zoom-head positioning is canceled.
- (2) When the small M has stopped blinking, press the “ZOOM” button and set the desired zoom-head position manually. When set in this way, the zoom-head position setting remains unchanged even if the power is turned ON or OFF, or the lens is changed.
 - To resume automatic zoom-head positioning, perform procedure (1) above to make the small M above the ZOOM disappear. If the small M is still visible, continue to press the “ZOOM” button.

Other camera/lens combinations

Adjust the zoom-head position manually to provide an angle of coverage that matches the focal length of the lens in use.

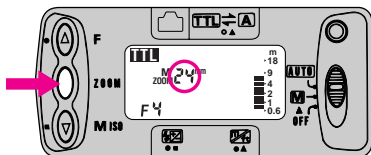

- 1 Press the “ZOOM” button to adjust the zoom-head position.

—The indicator changes every time you press the “ZOOM” button.
When using a Zoom-Nikkor lens, set the lens at its shortest length in order to cover the full zoom length range: (e.g., select the 28mm setting when using a Zoom-Nikkor 28–85mm lens.)

- 2 Confirm that the small M above the ZOOM is displayed in the LCD panel.

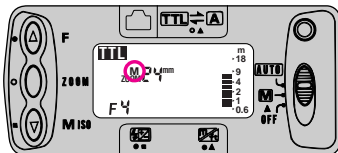

Basic flash operation

This section describes which SB-27 flash operations are available in AUTO mode for each camera group.

Automatic Balanced Fill-Flash
with TTL Multi Sensor



For details on each flash operation, refer to the Glossary of terms on pages 83 to 88.

See page 42 for Manual (M) flash operation.
See page 69 for non-TTL Auto Flash
with cameras in Groups I thru VI.

Selecting a flash mode

Set the flash mode selector to “AUTO” and flash modes for each camera group automatically become available.

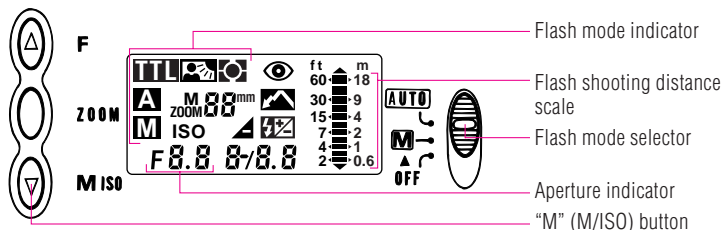

For available flash operations in each camera group, consult the table below.

Camera group	Available flash operation	Flash smode indicator	Reference page.
I ^{*/**}	• Automatic Balanced Fill-Flash with TTL Multi Sensor****	TTL	P. 24
	• Center-Weighted/ Spot Fill-Flash	TTL	
	• Standard TTL Flash	TTL	
II ^{*/**}	• Matrix Balanced Fill-Flash	TTL	P. 26
	• Center-Weighted/ Spot Fill-Flash	TTL	
	• Standard TTL Flash	TTL	
III	• Matrix Balanced Fill-Flash	TTL	P. 28
	• Center-Weighted/ Spot Fill-Flash	TTL	
	• Standard TTL Flash	TTL	
IV	• Matrix Balanced Fill-Flash	TTL	P. 30
	• Center-Weighted Fill-Flash	TTL	
V	• Programmed TTL Auto Flash	TTL	P. 32
	• Standard TTL Flash	TTL	
VI	• Standard TTL Flash	TTL	P. 36
VII ^{***}	• Non-TTL Auto Flash	A	P. 38

*The SB-27's flash mode indicator changes every time the "M" button is pressed.

** Center-Weighted Fill-Flash/Spot Fill-Flash is not possible with F80-Series/N80-Series and Pronea 600i/6i cameras.

*** Only possible when the camera setting switch is set to . (See page 13.)

**** Automatic Balanced Fill-Flash with TTL Multi Sensor is a general term for both 3D Multi-Sensor Balanced Fill-Flash and Multi-Sensor Balanced Fill-Flash.

Flash operation in AUTO mode (Cameras in

Procedures

1 Lens in use

2 Available flash operation*1

Camera settings

3 Metering system*2

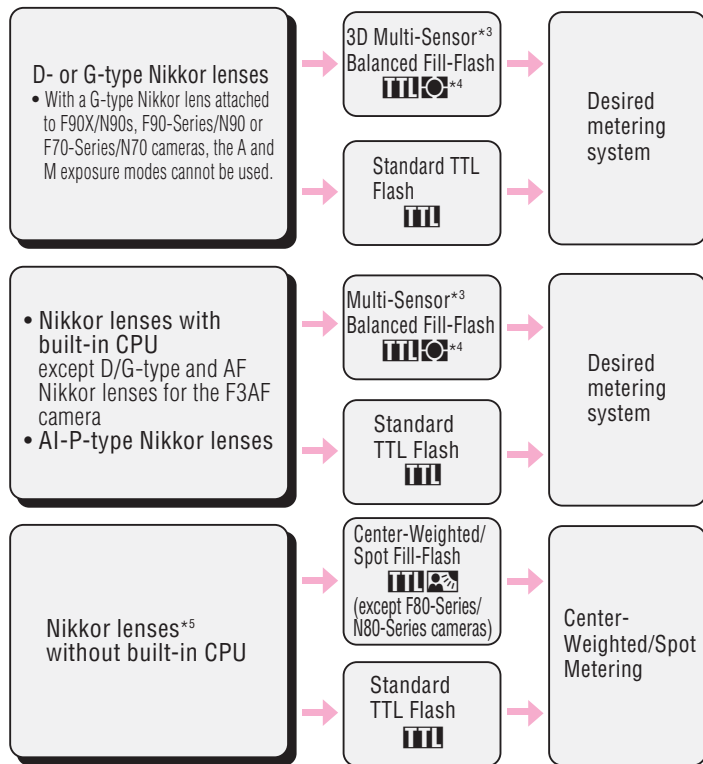

*1 Press the "M" button to change the SB-27's flash mode indicator.

*2 If the F5, F100, or F80-Series/N80-Series is set to Spot Metering, flash operation is automatically set to Standard TTL Flash.

*3 3D Multi-Sensor Balanced Fill-Flash and Multi-Sensor Balanced Fill-Flash are generally referred to as Automatic Balanced Fill-Flash with TTL Multi Sensor.

*4 When appears on the LCD panel, Monitor Preflash is possible.

*5 With a non-CPU lens attached to the F80-Series/N80-Series camera, set the exposure mode to Manual only. The camera's exposure meter cannot be used. Set and confirm the aperture using the lens aperture ring.

4 Exposure mode

P, S*7

A, M*7

A, M*7

5 Setting aperture and confirming flash shooting distance range*6

- 1) Set the lens to its minimum aperture (highest f-number) (except G-type Nikkor lenses)
- 2) Press the shutter release button halfway and check the flash shooting distance range in the LCD panel.

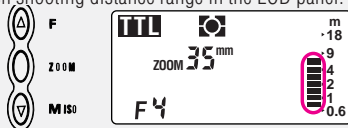

Press the shutter release button halfway. Check the indicator bars and the subject's distance as you rotate the camera's command dial or lens aperture ring to determine the aperture value.

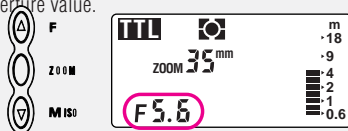

- 1) While looking at the indicator bars, press the "F" button to change the aperture and bring the subject within flash shooting distance range. Next, read the aperture value.



- 2) Set the corresponding aperture value on the lens aperture ring.

6 Shooting



If ready-light is ON, release shutter.

*6 With the F5's exposure mode set to S or M, when shutter speed is set to 1/300 sec. using a custom function setting, 1/300 TTL High-Speed Sync Flash can be selected. (For checking flash shooting distance range, see page 40.)

*7 S: Shutter-priority auto, P: Programmed auto,

A: Aperture-priority auto, M: Manual

Flash operation in AUTO mode (Cameras in

Procedures

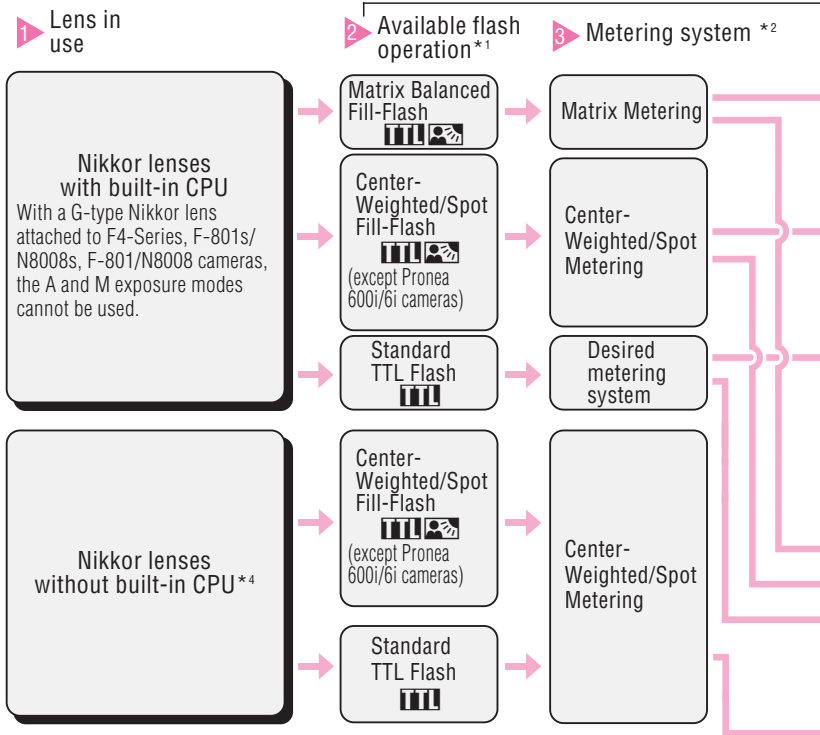

*1 Press the "M" button to change the SB-27's flash mode indicator.

*2 With an F4-Series camera set to Spot Metering, flash operation is automatically set to Standard TTL Flash mode.

*3 S: Shutter-priority auto, P: Programmed auto, A: Aperture-priority auto, M: Manual

*4 Matrix Balanced Fill-Flash operation is only possible with F4-Series camera even when AI-S or AI-type Nikkor lenses, Nikon Series E lenses, and lenses for the F3AF are mounted. With a non-CPU lens attached to Pronea 600i/6i cameras, set the exposure mode to Manual only. The camera's exposure meter cannot be used. Set and confirm the aperture using the lens aperture ring.

*5 Center-Weighted Fill-Flash/Spot Fill-Flash is not possible with Pronea 600i/6i cameras. Only Standard TTL Flash can be performed when the camera's exposure mode is set to Manual (M).

4 Exposure mode*5

P, S*3

A, M*3

A, M*3

5 Setting aperture and confirming flash shooting distance range

- 1) Set the lens to its minimum aperture (highest f-number) (except G-type Nikkor lenses)
- 2) Press the shutter release button halfway and check the shooting distance range in the LCD panel.

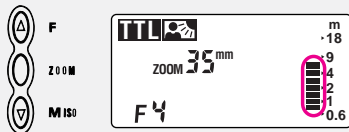

Press the shutter release button halfway. Check the indicator bars and the subject's distance as you rotate the camera's command dial or lens aperture ring to determine the aperture value.

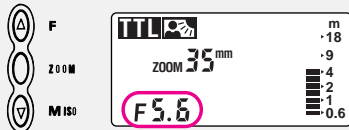

- 1) While looking at the indicator bars, press the "F" button to change the aperture and bring the subject within flash shooting distance range. Next, read the aperture value.

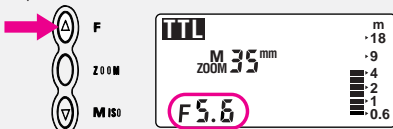

- 2) Set the corresponding aperture value on the lens aperture ring.

6 Shooting



If ready-light is ON, release shutter.

Flash operation in AUTO mode (Cameras in

Procedures

1 Lens in use

Nikkor lenses*¹
with built-in CPU

2 Available flash operation

Matrix Balanced
Fill-Flash



Center-
Weighted/Spot
Fill-Flash

Standard TTL
Flash

3 Flash mode and metering system

 Matrix
Metering

 Center-
Weighted/
Spot Metering

 Desired metering
system

Nikkor lenses
without built-in
CPU

Center-
Weighted/Spot
Fill-Flash

Standard TTL
Flash

 Center-
Weighted/
Spot
Metering*²

 Center-
Weighted/
Spot
Metering*²

*¹ G-type Nikkor lenses cannot be used with an F-601/N6006 camera.

*² Spot Metering is only available with F-601/N6006.

4 Exposure mode



5 Setting aperture and confirming flash shooting distance range

- 1) Set the lens to its minimum aperture (highest f-number)(except G-type Nikkor lenses).
- 2) Press the shutter release button halfway and read the controlled aperture in the camera's viewfinder.
- 3) Press the "F" button to set the corresponding aperture in the LCD panel, then confirm the flash shooting distance range.

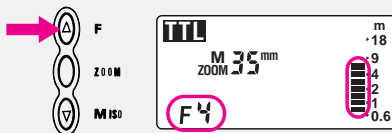

6 Shooting

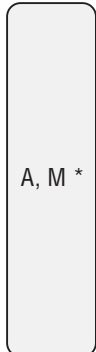
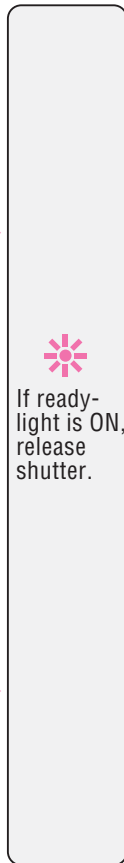

- 1) While looking at the indicator bars, press the "F" button to change the aperture and bring the subject within flash shooting distance range. Next, read the aperture value.

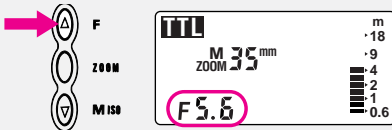

- 2) Set the corresponding aperture value on the lens aperture ring.

* S: Shutter-priority auto, P: Programmed auto,
A: Aperture-priority auto, M: Manual

Flash operation in AUTO mode (Cameras in

Procedures

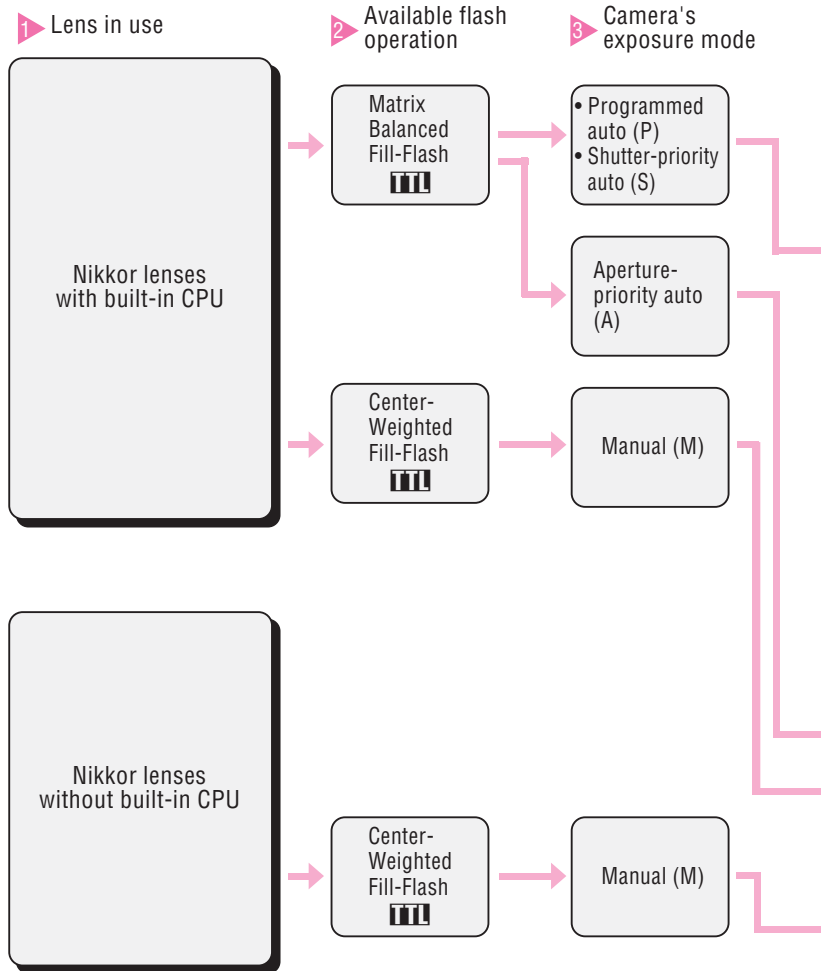

4 Setting aperture and confirming flash shooting distance range

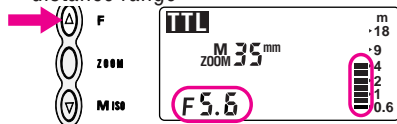

5 Shooting

- 1) Set the lens to its minimum aperture (highest f-number) (except G-type Nikkor lenses).
- 2) With an F60-Series/N60 or F50-Series/N50 camera in the ADVANCED mode, set the aperture appearing in the camera's viewfinder on the SB-27's LCD panel by pressing the SB-27's "F" button. Then confirm the flash shooting distance range.

F50-Series/N50	Flash shooting conditions (ISO 100)	Sunny day	Cloudy day or in shadows	Indoors
	Aperture setting on SB-27 *		f/8	f/5.6

*With an F50-Series/N50 camera in the SIMPLE mode, select the aperture from the table above and set the same aperture on the SB-27's LCD panel by pressing the SB-27's "F" button. Then confirm the flash shooting distance range.

F-401x/N5005	Flash shooting conditions (ISO 100)	Backlit by the sun	Sunny day	Cloudy day or in shadows	Indoors	
	Aperture setting on SB-27		f/16	f/8	f/5.6	f/5.6
	Usable shutter speed in shutter-priority auto mode**		1/125 sec			1/30 sec

**Aperture is automatically selected by the camera.



If ready-light is ON, release shutter.

- 1) Set the lens to its minimum aperture (highest f-number) (except G-type Nikkor lenses).
- 2) While looking at the indicator bars, press the "F" button to change the aperture and bring the subject within flash shooting distance range. Next, read the aperture value
- 3) Set the corresponding aperture in the F60-Series/N60 or F50-Series/N50's LCD panel (for F-401x/N5005, rotate the aperture dial).

- 1) While looking at the indicator bars, press the "F" button to change the aperture and bring the subject within flash shooting distance range. Next, read the aperture value.
- 2) Set the corresponding aperture on the camera.

Flash operation in AUTO mode (Cameras in

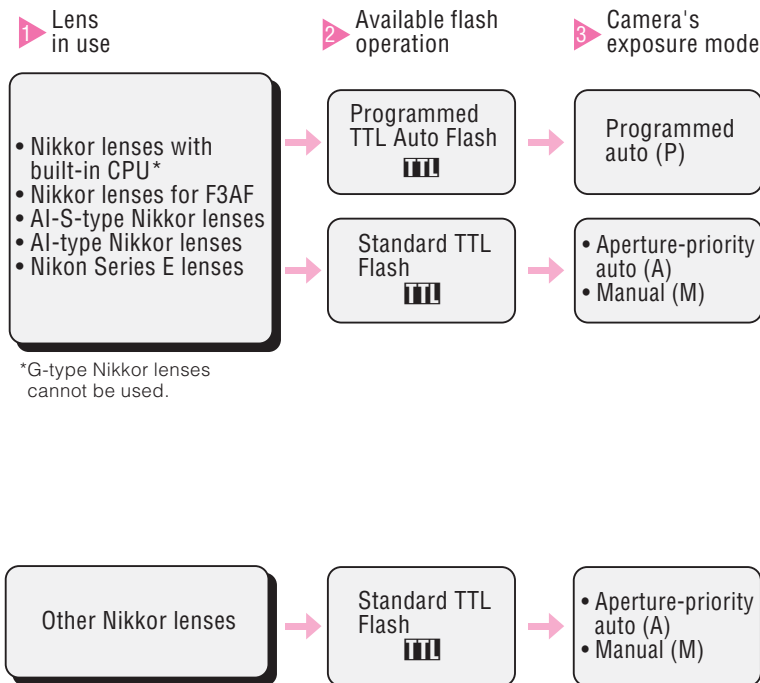
Procedures



4 Setting aperture and confirming flash shooting distance range

- 1) Set the lens to its minimum aperture (highest f-number).
- 2) Read the suggested aperture for the film in use in the table below, press the "F" button to set the corresponding aperture in the LCD panel, then confirm the flash shooting distance range.

ISO film speed	25	50	100	200	400	800
Aperture	f/2.8	f/4	f/5.6	f/8	f/11	f/16

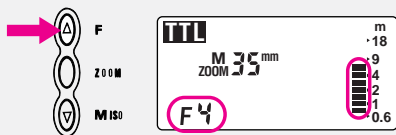

- 1) While looking at the indicator bars, press the "F" button to change the aperture and bring the subject within flash shooting distance range. Next, read the aperture value.

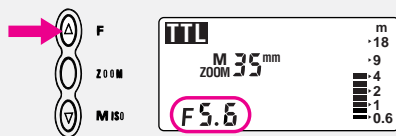

- 2) Set the corresponding aperture value on the lens aperture ring.

5 Shooting



If ready-light is ON, release shutter.

Flash operation in AUTO mode (Cameras in

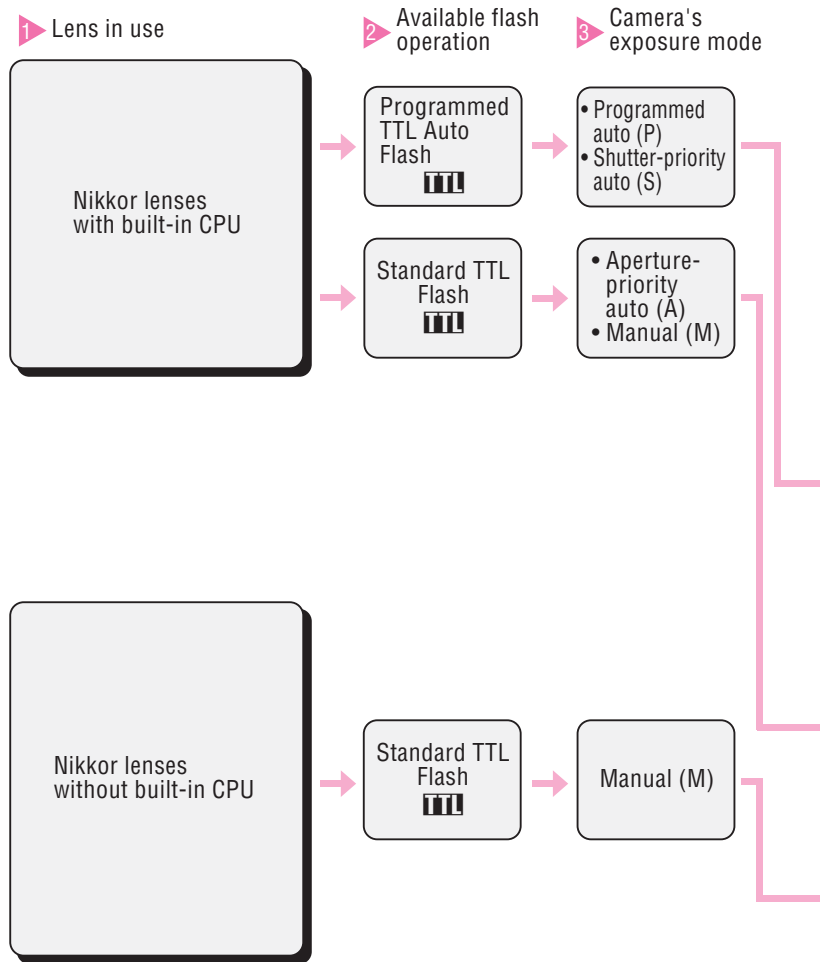
Procedures

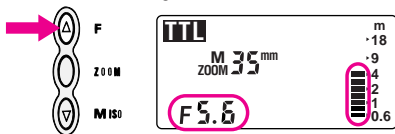

4 Setting aperture and confirming flash shooting distance range



5 Shooting

- 1) Set the lens to its minimum aperture (highest f-number) (except G-type Nikkor lenses).
- 2) Read the aperture in the table below, and press the "F" button to set the corresponding aperture in the LCD panel, then confirm the flash shooting distance range.

Flash shooting conditions	Backlit by the sun	Sunny day	Cloudy day or in shadows	Indoors
Aperture (ISO 100)	f/16	f/8	f/5.6	f/5.6
Usable shutter speed	1/125 sec			1/30 sec

*In shutter-priority auto (S) mode, aperture is automatically selected by the camera.

If ready-light is ON, release shutter.

- 1) Set the lens to its minimum aperture (highest f-number) (except G-type Nikkor lenses).
- 2) While looking at the indicator bars, press the "F" button to change the aperture and bring the subject within flash shooting distance range. Next, read the aperture value.
- 3) Set the corresponding aperture value on the camera aperture dial.

- 1) While looking at the indicator bars, press the "F" button to change the aperture and bring the subject within flash shooting distance range. Next, read the aperture value.
- 2) Set the corresponding aperture value on the lens aperture ring.

Flash operation in AUTO mode (Cameras in

Procedures

1 Lens in use

Nikkor lenses with built-in CPU*
Nikkor lenses without built-in CPU

2 Available flash operation

Standard TTL
Flash



*G-type Nikkor lenses cannot be used.



Do not use the SB-27 for underwater photography.

Group VI: FM3A, FA, FE2, FG, Nikonos V)

3 Camera's exposure mode

Aperture-priority auto (A)^{*1}

Manual (M)^{*2}

4 Setting aperture and confirming flash shooting distance range

1) While looking at the indicator bars, press the "F" button to change the aperture and bring the subject within flash shooting distance range. Next, read the aperture value.



2) Set the corresponding aperture value on the lens aperture ring.

5 Shooting



If ready-light is ON, release shutter.

*1 In this exposure mode, shutter speed is automatically set to 1/250 sec. (for FM3A, FA, FE2), and 1/90 sec. (for FG, Nikonos V).

*2 Standard TTL Flash is not possible if the shutter speed is set to M250 or B (bulb) (for FA, FE2), and M90 or B (Bulb) (for FG, Nikonos V).

Flash operation in AUTO mode (Cameras in Group VII:

With cameras in Group VII, be sure to set the camera setting switch (inside the SB-27's battery chamber) to , and choose "AUTO" (in the flash mode selector); the flash mode is automatically set to Non-TTL Auto Flash.

—In non-TTL Auto Flash mode, flash mode indicator **A** appears in the SB-27's LCD panel.

Procedures

1 Lens in use

Nikkor lenses with built-in CPU*
Nikkor lenses without built-in CPU

2 Available flash operation

Non-TTL Auto
Flash
A

*G-type Nikkor lenses cannot be used.

NOTE

- Set the lens to the same aperture value as in the SB-27 to obtain a correct exposure.
- A usable aperture value appears in the SB-27's LCD panel whenever you press the "F" button.

3 Camera's exposure mode

- Aperture-priority auto (A)
- Manual (M)

4 Setting aperture and confirming flash shooting distance range

1) While looking at the indicator bars, press the "F" button to change the aperture and bring the subject within flash shooting distance range. Next, read the aperture value.

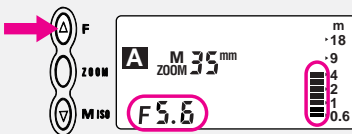

2) Set the corresponding aperture value on the lens aperture ring.

5 Shooting

If ready-light is ON, release shutter.

If the ready-light blinks after shooting

The ready-lights in the SB-27 and the camera blink for approx. 3 seconds after shooting to signal that the flash has fired at full output but the light may have been insufficient.

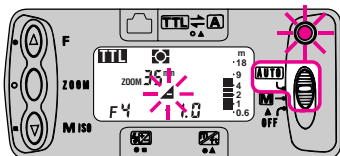

—When using the SB-27 with cameras in Group I, the underexposure indicator  blinks in the SB-27's LCD panel and the amount of underexposure is indicated.

Reshooting

- Reconfirm flash-to-subject distance and flash shooting distance range when shooting in programmed auto (P) or shutter-priority auto (S) exposure mode, or choose aperture-priority auto (A) or manual (M) exposure mode. Select an aperture that will allow you to bring the subject within flash shooting distance range.

Flash shooting distance range in 1/300 TTL High-Speed Sync Flash operation (F5 only)

Flash shooting distance range (far side) cannot be read from the indicator bars on the SB-27 in AUTO flash mode.

In such a case, use the following "Guide number" table and equation for calculating the shooting distance according to each zoom-head position.

Guide number (at ISO 100 for m/ft)

Zoom head position	24mm	28mm	35mm	50mm
Guide number	11/36	12/39	14/46	16/52

$$D \text{ (flash shooting distance)} = \frac{\text{Guide number}}{f/\text{stop (aperture)}}$$

For example, when shooting with ISO 100 film, at a 35mm zoom-head position and an aperture of f/5.6:

$$D = 14/5.6 = 2.5 \text{ (far side) [measured in meters]}$$

You can read a shooting distance (near side) of 0.6m from the SB-27's indicator bars. Therefore, the flash shooting distance ranges from 0.6m to 2.5m.

For films other than ISO 100, multiply the figures in the table above by the factors shown below.

ISO film speed	25	50	200	400	800
Factor	x0.5	x0.71	x1.4	x2	x2.8

Advanced flash operation

This section describes advanced flash shooting applications with the SB-27 Speedlight.

Bounce flash



Multiple flash



Flash operation in Manual (M) mode (For

With the SB-27's flash mode selector set to "M," light output can be manually controlled.

—Indicator bar "■" in the LCD panel shows the approximate flash shooting distance range. To determine the correct aperture value, see page 46 on "Guide numbers for determining the correct aperture."

- 1 Set the camera's exposure mode to aperture-priority auto (A) or manual (M).

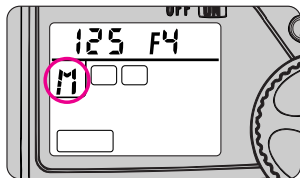

F90X/N90s LCD panel shown

- 2 Set the SB-27's flash mode selector to "M".

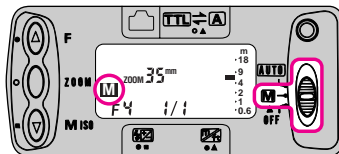

In Manual (M) mode, confirm that the **M** indicator appears in the LCD panel.

- 3 Press the “M” button to choose the desired light output.

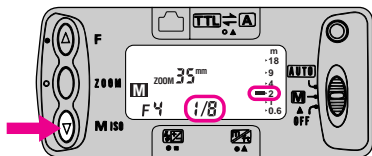

You can select light output settings ranging from full power (1/1) to one-sixteenth (1/16). LCD indicators change as follows:
1/1 → 1/2 → 1/4 → 1/8 → 1/16.

- 4 Setting the aperture on both the SB-27 and the camera

Cameras in Groups I and II with Nikkor lenses with built-in CPU

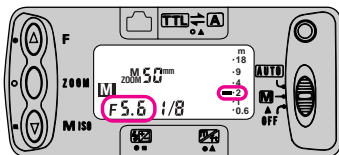
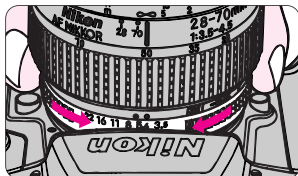

Rotate the camera's command dial or lens aperture dial; the indicator bar “—” in the LCD panel changes. Before shooting, make sure your subject is within flash shooting distance range.

Flash operation in Manual (M) mode (For cameras

Other camera/lens combinations

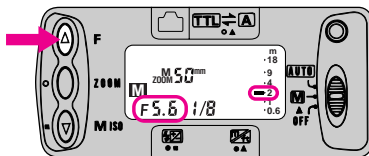

- 1) While looking at the indicator bar “—”, press the “F” button to change the aperture and bring the subject within flash shooting distance range. Next, read the aperture value.
- 2) Set the corresponding value on the lens aperture ring or on the camera.

NOTE

Manual light output control and aperture selection:

- To extend the flash shooting distance range, select the 1/1 light output setting or set the lens to a larger aperture (lower f-number). To reduce the flash shooting distance range, select the 1/16 light output setting or set the lens to a smaller aperture (higher f-number).
- To ensure sharpness in both background and foreground, set the lens to a smaller aperture (higher f-number), and select a larger light output setting (closer to 1/1).
- To shorten flash recycling time, select a much smaller light output setting (closer to 1/16) and set a larger aperture (lower f-number).

5

Confirm that the ready-light is ON, then fully depress the shutter release button to fire the flash.

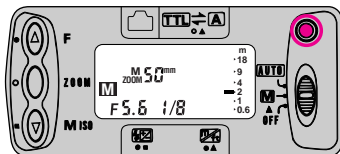

Synchronization in continuous shooting

The SB-27 is able to recycle fast enough to synchronize with a motor-driven camera firing continuously up to 15 flashes per second. It is possible to take up to four full flash pictures in rapid succession at a light output ranging from 1/8 to 1/16 (using the SB-27's internal batteries) in Manual (M) Flash mode.

Number of continuous flash (frames) in Manual (M) Flash mode

Power source	Light output	
	1/8	1/16
AA-type alkaline-manganese (four sets) inside the SB-27	4	8
Optional external power source SD-7 + AA-type alkaline-manganese (four sets) inside the SB-27	6	10
Optional external power source SD-8/8A + AA-type alkaline-manganese (four sets) inside the SB-27	5	10

Note: The maximum number of flashes may vary with the type of battery and the ambient temperature.



Allow the Speedlight to cool off for at least 10 minutes after continuous firing (see the table below). Overuse generates heat that could shorten the life of the Speedlight.

Safety range in continuous firing

SB-27's light output	Max. number of flashes
AUTO and Manual (M) mode at 1/1 or 1/2 light output	15
Manual (M) mode at 1/4, 1/8 or 1/16 light output	40

We recommend letting the flash unit cool off after any level of intensive use.

Guide numbers for determining correct aperture

The “guide number” represents the amount of light generated by the flash. With the SB-27 in Manual (M) Flash mode, you can calculate a correct aperture (f/stop) value by using the following equation and the “Guide number” table. —For Guide numbers in 1/300 TTL High-Speed Sync Flash operation with the F5 camera, see page 40.

To calculate a correct aperture:

$$\text{f/stop (aperture)} = \frac{\text{guide number}}{\text{flash-to-subject distance (m)}}$$

To calculate the shooting distance:

$$\text{flash-to-subject distance (m)} = \frac{\text{guide number}}{\text{f/stop (aperture)}}$$

Guide number (at ISO 100: for m/ft)

(at 20°C/68°F)

Light Output	Zoom-head position			
	24mm	28mm (normal)	35mm	50mm
1/1 (full)	25/82	27/89	30/98	34/112
1/2	17.7/58	19/62	21.2/69	24/79
1/4	12.5/41	13.5/44	15/49	17/56
1/8	8.8/29	9.5/31	10.5/34	12/39
1/16	6.2/20	6.7/22	7.4/24	8.5/28

The guide number varies with the film speed. For films other than ISO 100, multiply the above figures by the factors shown in the table below.

Adjustment factors for other ISO film speeds

ISO film speed	25	50	200	400	800	1600
Factor	× 0.5	× 0.71	× 1.4	× 2	× 2.8	× 4

For example, when shooting a subject under the following conditions,

- Light output: 1/1 (full),
- Flash mode: Manual (M),
- Film speed: ISO 400,
- Zoom-head position: 35mm,

you will obtain a guide number of 60 (30 × 2) using the above table.

Autofocus flash operation in dim light

(For AF SLR cameras only)



Nikon AF SLR cameras using AF Nikkor lenses can autofocus in light as dim as a single candle. When ambient light is insufficient for autofocus operation, the SB-27's AF assist illuminator LED automatically turns ON to give contrast to dark subjects, enabling the camera's autofocus system to function when the shutter release button is pressed halfway.

Take care not to block the AF assist illuminator LED.

—The AF assist illuminator LED goes out as soon as the subject has been correctly focused.

- No AF assist illuminator LED lights up if the F5's, F100's, F80-Series/ N80-Series' or F65-Series/N65-Series' central focus area is not selected. Be sure to select the central focus area.

Conditions for autofocus flash operation with the AF assist illuminator LED

- 1) The subject must be sufficiently dark to activate the autofocus assist illuminator LED.

Please note that AF assisted autofocus range extends from 1m (3.3 ft.) to 5m (16.4 ft.) at 20°C (68°F).

- 2) AF Nikkor lenses must be used.

Using AF Nikkor lenses, SB-27's focal length coverage ranges from 24mm (35mm for F-501/N2020) to 105 mm.

Other AF Nikkor lenses may also be used depending on shooting conditions. Be sure to take a few trial shots first.

- 3) The camera's autofocus mode should normally be set to Single Servo AF (S).

- 4) Focus lock is not in use.

- 5) The ready-light is ON.

If the ready-light becomes dim or blinks after the AF assist illuminator LED lights up, replace the SB-27's batteries with a fresh set.

*If the AF assist illuminator LED comes ON but no in-focus indicator appears in the camera's viewfinder with the shutter release button pressed halfway, the subject is beyond autofocus distance range. Set the focus mode to "Manual" and focus manually on the clear matte field.

Bounce flash operation

(For cameras in all groups)

Normal flash shooting using direct flash



Bounce flash shooting using diffused light

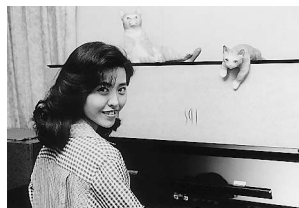

Direct flash causes harsh, unattractive shadows to appear on the faces of subjects in front of a wall. By bouncing the light off the ceiling or walls, you can soften the shadows and produce more natural portraits.

Vertically bounced light

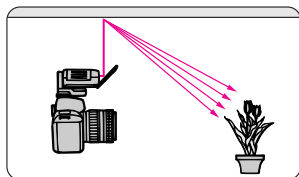

The flash head rotates from the horizontal to the vertical position along a 180° arc.

Built-in diffuser card

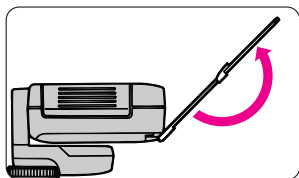

The SB-27 comes with a built-in diffuser card, useful for highlighting a subject's eyes during bounce flash operation. (See page 53.)

Notes on taking pictures with vertical bounce flash

The settings of the built-in bounce flash adapter and the diffuser card vary depending on the focal length of the lens in use.

Nikkor lenses 35mm and longer

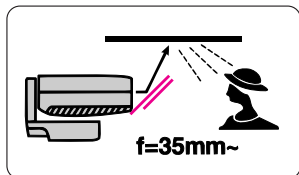

Set the built-in bounce flash adapter as shown.

—When set as above, you cannot use Nikkor lenses wider than 35mm. (See the illustration [center] on the seal affixed to the bounce flash adapter.)

Also set the diffuser card when you want to create a "catchlight" to highlight the subject's eyes. (See page 53.)

Nikkor lenses 24mm and longer

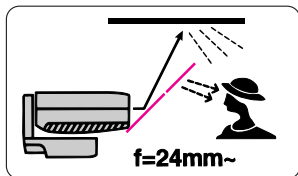

Set both the built-in bounce flash adapter and diffuser card as shown.

—Even when set as above, you cannot use Nikkor lenses wider than 24mm. (See the illustration [bottom] on the seal affixed to the bounce flash adapter.)

Always set the diffuser card whether you wish to create a "catchlight" or not. (See page 53.)

Notes on taking pictures with flash in vertical position



- With the built-in bounce flash adapter mounted, use Nikkor lenses 50mm or longer.
- With both the built-in bounce flash adapter and the diffuser card mounted, use Nikkor lenses 35mm or longer.

Procedures for bounce flash operation

- 1 Set the camera's exposure mode to aperture-priority auto (A) or manual (M).
With bounce flash operation, there is 2 to 3 f/stops less light available than in normal flash operation. We recommend that you select wider aperture (lowest possible f-number) and bracket to ensure correct exposure.

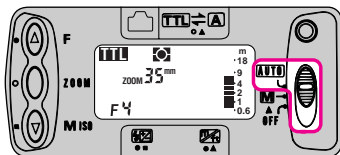
- 2 Set the SB-27's flash mode selector to "AUTO".



Make sure you set the camera setting switch to  STBY with cameras in Groups I thru VI, and to  with cameras in Group VII. (Do not select the  STBY setting with cameras in Group VII.)

- 3 Check the reflective surface and adjust flash head direction.

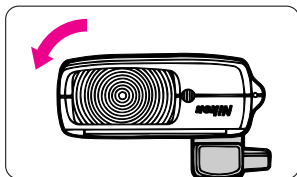

NOTE

Choose a reflective surface with a high reflection factor such as a white wall for bouncing the light off.
In color photography, only use bounce against white reflective surfaces. Otherwise, color photographs will come out with an unnatural color cast similar to that of the reflective surface.

- 4 Set up the built-in bounce flash adapter.

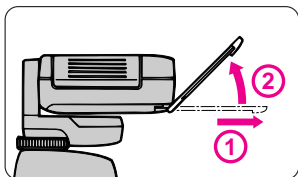

Pull out the bounce flash adapter ①, then raise it approx. 45° ②. (The bounce flash indicator  appears in the LCD panel.)
—Do not force the bounce flash adapter.

- 5 Confirm that the ready-light is ON, then release the shutter to fire the flash.

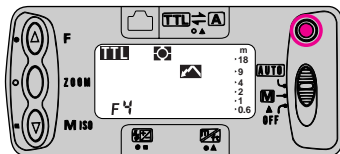

If the ready-light blinks for 3 seconds after shooting, reconfirm the flash shooting distance range or select a wider aperture, and then reshoot.

—In bounce flash operation, no indicator bars appear in the LCD panel. (The SB-27 no longer indicates the correct relationship between aperture and flash shooting distance range.)

Highlight your subject's eyes using bounced flash

The SB-27 comes with a built-in bounce flash adapter for bouncing diffused light off the ceiling. The diffuser card brightens shadows caused by top-lighting or bouncing flash, making your subject's eyes appear more vibrant.

To set up the diffuser card:

- 1 Set the built-in bounce flash adapter.

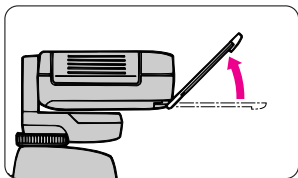

- 2 Unfold the built-in diffuser card.

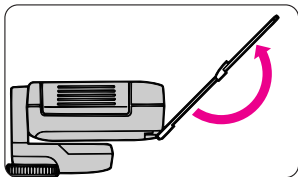

Close-up flash operation in AUTO mode

(Cameras in Groups I thru VI)



The SB-27 incorporates a built-in diffuser card which diffuses light, enabling you to take close-up flash pictures from 0.3m (1 ft.), softening harsh shadows and producing natural-looking results with the SB-27 mounted on the camera.

Two methods are possible:

- (1) Mounting the SB-27 on the camera (See page 56.)
- (2) Connecting the SB-27 to the camera using an optional TTL Remote Cord (See page 59.)

—With a very light or dark-toned subject, you may not get a correct exposure due to the subject's reflection factor. See page 60 on "Exposure compensation for flash photography" and page 69 on "Setting Forced TTL and Forced A modes" to ensure correct exposure.

Notes on close-up flash operation

Take note of the following points when shooting close-ups with the SB-27 mounted on the camera.

Usable lenses are limited.

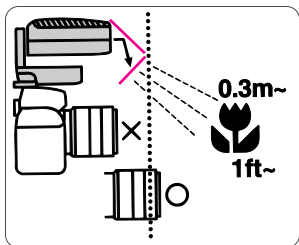

Avoid using any Nikkor lens whose actual length is shorter than that of the built-in bounce flash adapter (..... line in the illustration). If the lens is too short, the incident light falling on the lens reflects on the built-in bounce flash adapter causing a flare effect on the film. (See the illustration [top] on the seal affixed to the bounce flash adapter.

Other notes

In close-up flash operation, we recommend taking trial shots first because pictures may be slightly dim or a shadow may appear around the edge of the frame depending on the lens in use or the flash-to-subject distance.

Procedures (with the SB-27 mounted on the camera)

1

Set the camera's exposure mode to aperture-priority auto (A) or manual (M).

—For cameras in Group I to VI, in addition to selecting Aperture Priority or Manual, the Close Up Program within the Vari-Programs can also be used.

2

Set the SB-27's flash mode selector to "AUTO".

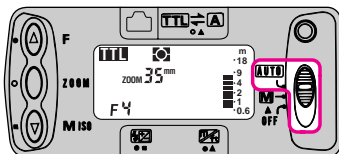

3

Pull out the built-in bounce flash adapter.

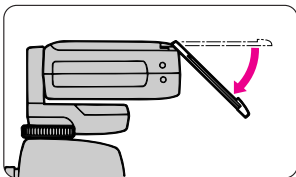

Pull out the bounce flash adapter all the way and tilt it downward approx. 45°. (The bounce flash indicator  appears in the LCD panel.)

—Do not force the bounce flash adapter.

NOTE

If the bounce flash adapter comes off and you cannot set the zoom-head position corresponding to the lens in use.

Simultaneously press the "ZOOM" and "F" buttons for approx. 4 seconds. The zoom-head position indicator then blinks, and you can proceed with automatic or manual zoom-head setting. Four stops (24mm, 28mm, 35mm and 50mm) are available with the flash-head in the horizontal position, and 3 stops (35mm, 50mm and 70mm) with the flash-head in the vertical position, depending on the camera/lens combination. (See page 20.)

4 Set up the diffuser card as shown.

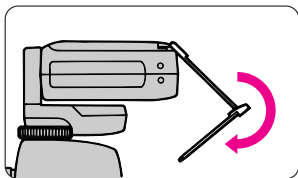

The SB-27's built-in diffuser card is effective for close-up flash operation from 0.3m (1 ft).

—Avoid using the built-in diffuser card for close-up flash operation in non-TTL Auto Flash mode. (You cannot obtain a correct exposure if the diffuser card is set.)

5 Set the camera's aperture based on the following equation and table.

$$f/\text{stop} \geq \frac{\text{coefficient}}{\text{flash-to-subject distance (m)}}$$

ISO film speed and coefficient

ISO film speed	100 or lower	125–400	500 or higher
Coefficient*	1 (3.3)	2 (6.6)	2.8 (9.2)

*Numbers in parentheses () represent coefficient for foot measurement.

For example, with a subject located 0.5m (1.6 ft) away using ISO 100 film and a bounce flash adapter, this is how you would calculate the aperture:

$$f/\text{stop} \geq \frac{1}{0.5} = 2^*$$

* An aperture of $f/2$ is suggested. We recommend using the smallest possible aperture ($f/2.8$ or $f/4$).

6 Confirm that the ready-light is ON, then release the shutter to fire the flash.

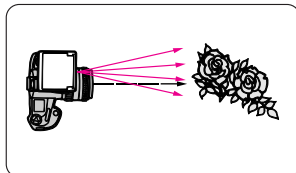
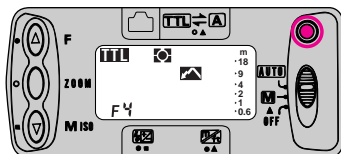

If the ready-light blinks for 3 seconds after shooting, see page 40.

Close-up flash operation using a TTL Remote Cord

When you want to ensure sufficient illumination, or illuminate your subject from the side or the back, detach the SB-27 from the camera and use an optional TTL Remote Cord.

- 1 Connect the SB-27 to the camera using a TTL Remote Cord.

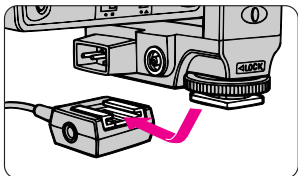



- Use optional TTL Remote Cord SC-24 when connecting the SB-27 to an F4-Series camera fitted with a High-Magnification Finder (DW-20 or DW-21).
- Use optional TTL Remote Cord SC-17 when connecting the SB-27 to other cameras with an ISO type hot shoe.

- 2 After first setting the camera's exposure mode to A or M, set the SB-27's flash mode selector to "AUTO."

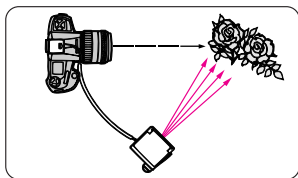
- 3 Position the SB-27 properly and adjust the angle.



- Be sure to position the SB-27 and adjust the angle so as to sufficiently illuminate the subject.

In 3D Multi-Sensor Balanced Fill-Flash operation with cameras in Group I, press the "M" button to change the flash mode indicator from  to  in order to cancel Monitor Preflash*. This will avoid exposure errors when removing the SB-27 from the camera. (See page 63.)

*See page 86 on Monitor Preflash.

4 Set the camera's aperture based on the following equation and table.

$$f/\text{stop} \geq \frac{\text{coefficient}}{\text{flash-to-subject distance (m)}}$$

ISO film speed and coefficient

ISO film speed	100 or lower	125–400	500 or higher
Coefficient*	4 (14)	8 (26)	11 (36)

*Numbers in parentheses () represent coefficient for foot measurement.

For example, with a subject located 0.5m (1.6 ft) away using ISO 100 film, this is how you would calculate the aperture:

$$f/\text{stop} \geq \frac{4}{0.5} = 8^*$$

* An aperture of f/8 is suggested. We recommend using the smallest possible aperture (f/11 or f/16).

With a very light or dark-toned subject, you may not obtain a correct exposure due to the subject's reflection factor. Use exposure compensation to ensure correct exposure. (See pages 60, 69.)

5 Confirm that the ready-light is ON, then release the shutter to fire the flash.

Exposure compensation for flash photography

"Plus" compensation



"Minus" compensation



In AUTO (TTL Auto Flash) mode, difficult scenes, such as bright objects in the background, or a main subject at the edge of the frame, may cause overexposure or underexposure. You can manually adjust the exposure (compensate the Speedlight's light output level in TTL Auto Flash mode) to make the picture lighter or darker. When the background is extremely bright, use "+" compensation and when the background is very dark, use "-" compensation.

- In Automatic Balanced Fill-Flash with TTL Multi Sensor operation using cameras in Group I, the camera automatically compensates exposure according to the shooting conditions. Flash light output level compensation is not necessary inside the normal flash shooting distance range.
- Make sure that the flash shooting distance range shifts when the exposure is compensated. Check that the subject is within flash shooting distance range after compensation.

Setting exposure compensation for flash

The setting method varies depending on the camera.

Cameras in Groups I and II

Cameras with EV compensation control capability allow you to compensate flash exposure on either the SB-27 or the camera (or both.) If you use both controls, exposure is modified by the sum total of both exposure compensation values.

For example, with a compensation of +1EV on the SB-27 and +1EV on the camera, the background will be +1EV and the flash output will be +2EV. Keep in mind that the SB-27's exposure compensation value indicator will not display the sum total of both compensation values. Only the compensation value set on the SB-27 is displayed.

Setting exposure compensation on the SB-27

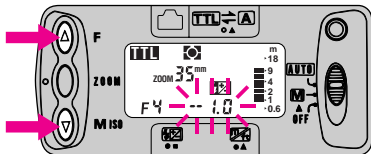

- 1) Simultaneously press the “F” and “M” buttons .
- 2) Confirm the exposure compensation value indicator in the LCD panel appears after blinking for approx. 4 sec.
- 3) To set the desired exposure compensation, press the “F” button to increase the compensation value and press the “M” button to decrease the compensation value.
- 4) The exposure compensation indicators  and exposure compensation value come on.
Exposure compensation is possible in 1/3 EV steps. (“-” side: from -0.3 to -3.0 EV, and “+” side: from +0.3 to +1.0 EV) .

Canceling exposure compensation

Flash exposure compensation cannot be canceled by turning the power OFF. To cancel, reset the exposure compensation amount to 0.0 following the same steps outlined on page 61.

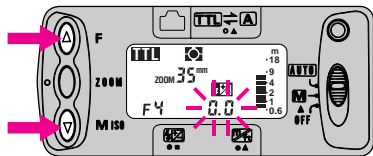

Cameras in Group III

Use the camera's EV compensation control function to make exposure compensation.

—For further details, refer to the camera's Instruction Manual.

With Group III cameras, the SB-27's LCD panel does not show the correct flash shooting distance range or the correct compensation amount. Use the following chart as a guide for obtaining the correct flash shooting distance range.

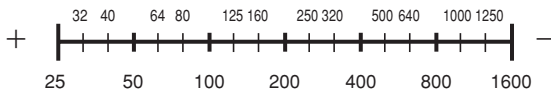

For example, with ISO 100 film, if you want to compensate by +1EV on the camera, set the ISO film speed to 50 on the SB-27's LCD panel; if you want to compensate by -2EV, set the ISO film speed to 400.

NOTE

With exposure compensation set on the camera, the SB-27's light output is automatically controlled for correct background illumination.

Multiple flash operation—using more than one Speedlight

(Applicable to all camera groups)

Flash shooting with one flash unit



Flash shooting with more than one unit



When you wish to eliminate harsh shadows produced by a single flash unit or if you want to extend light up into the background, use more than one flash unit.

For multiple flash operation with the SB-27, both TTL Auto and Manual (M) Flash modes are available.

- Multiple flash operation in TTL Auto Flash mode is possible with cameras in Groups I thru VI and F3-Series cameras. Multiple flash operation in Manual (M) Flash mode is possible with cameras in all groups.
- In multiple flash operation in either TTL or manual mode, first decide which will be the main (Master) unit and which the secondary (Slave) unit(s). For example, to eliminate shadows, adjust the lighting ratio so that master unit illumination is greater than secondary unit illumination.

NOTE

Cameras in Group I

With the SB-27 as the master flash set to 3D Multi-Sensor Balanced Fill-Flash, you may not be able to obtain correct exposure because of a change in lighting conditions between initial Monitor Preflash* and actual flash firings. First cancel Monitor Preflash using one of the following methods:

- Set the built-in wide flash adapter to the upper or left direction.
- Set the SB-27's flash operation to Standard TTL Flash (not Matrix Balanced Fill-Flash.)
- Mount a Nikkor lens without built-in CPU.
- Set the camera's metering system to Spot (except F90X/N90s, F90-Series/N90, F70-Series/N70 cameras).

*See page 86 on Monitor Preflash.



TTL multiple flash operation procedures

See page 66 on usable flash units and accessories for multiple flash operation.

- 1 Mount the SB-27 as a master flash unit on the camera.
- 2 Connect the master flash unit to the slave flash unit(s).
—Turn OFF all flash units when connecting.
- 3 Set the flash mode selector of all the flash units to TTL.
—Do not set the power switch to the STBY position.

NOTE

Using the SB-27 as a slave flash unit (for cameras in Groups I thru VI)

When using the SB-27 as a slave unit, set the camera setting switch to  in order to activate the Forced TTL function (see page 69). Forced TTL simply disables the standby function. If the camera setting switch is set to  STBY, the standby function will work and the slave flash will not fire.

- 4 **Setting up a master flash unit and slave unit(s)**
Set the zoom-head position and the flash-to-subject distance on the master flash unit. Set up the slave unit(s) in the same way.
- 5 Follow the same procedures as in normal TTL Auto Flash mode.

NOTE

Cameras in Groups I thru IV

- In multiple flash operation, if the electric current in the synchro circuit exceeds a certain level, you may not be able to take a second shot after the first. In this case, turn each of the flash units OFF once or disconnect the master flash unit from the camera. This resets the circuits so you can resume shooting.
- In multiple flash operation, take care that the combined total of the coefficient (numbers shown in parentheses below) for all flash units used at any one time does not exceed 20 at 20°C (68°F), or 13 at 40°C (104°F).

Speedlight coefficients

SB-80DX (1), SB-50DX (1), SB-30 (1), SB-29s/29 (1), SB-28/28DX (1), SB-27 (1), SB-26 (1), SB-25 (1), SB-24 (1), SB-23 (4), SB-22s (1), SB-22 (6), SB-21 (4), SB-20 (9), SB-17 (4), SB-16 (4), SB-15 (4), SB-14 (1), SB-11 (1), SB-140 (1)

Coefficient numbers in parentheses above are in units of 70µA.

TTL multiple flash operation using the Wireless Slave Flash Controller SU-4 (optional)

- TTL multiple flash operation is possible by using the camera's built-in Speedlight or a Speedlight mounted on the camera's hot shoe as the master flash unit, and one or more Speedlights mounted on the Wireless Slave Flash Controller SU-4s as slave flash units. The SU-4's built-in light sensor not only detects when the master flash unit fires to trigger the slave flash unit, but also controls the flash duration of the slave flash unit in sync with the master flash unit.

Manual multiple flash operation is also possible by setting the flash mode selector to manual (M).

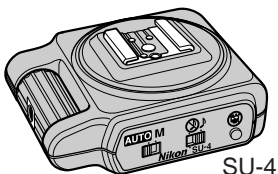

- These Nikon Speedlights are usable: SB-29s/29, SB-28/28DX, SB-27, SB-26, SB-25, SB-24, SB-23, SB-22s, SB-22, SB-20, SB-18, SB-16B, SB-15
- For more information, refer to the instruction manual provided with the SU-4.

Multiple flash operation—(Cameras in Groups I thru VI)

System chart for TTL multiple flash

- SB-11, SB-14, SB-140, and SB-21B Speedlights cannot be used with the F-401/N4004 or F-401s/N4004s either as a master or a slave unit.

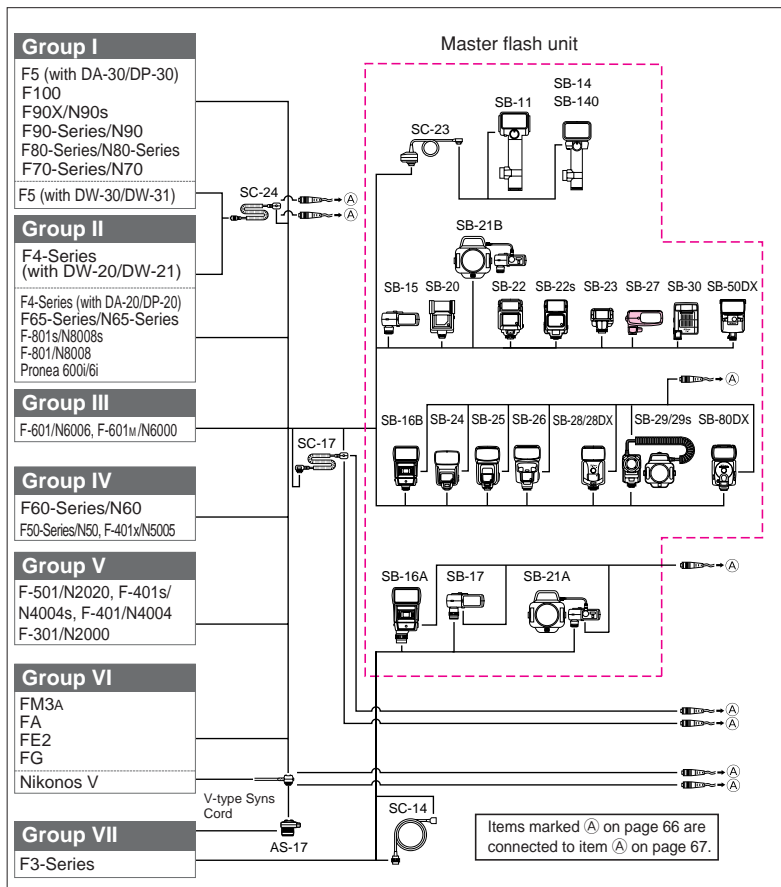

Slave flash unit

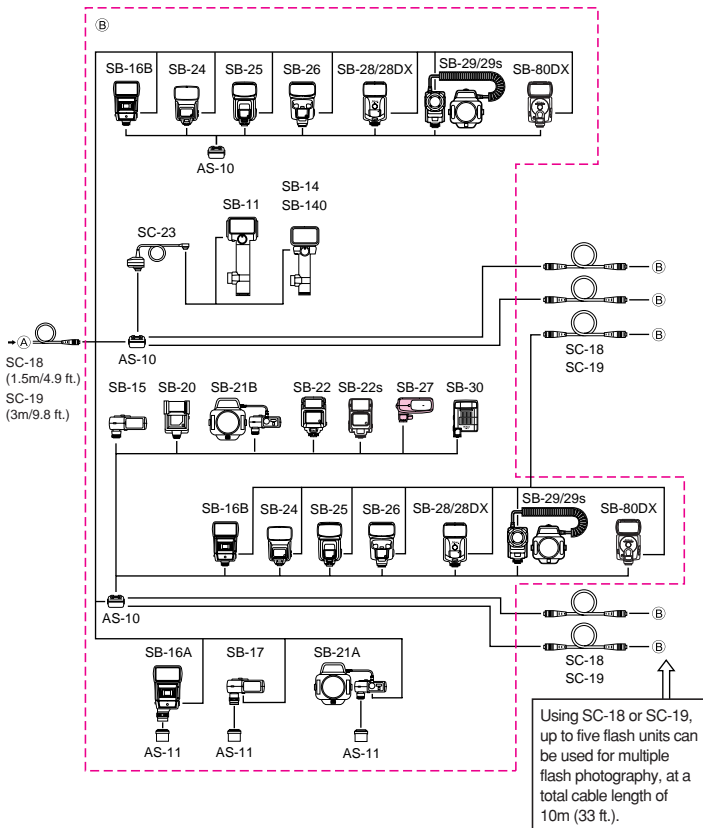

Manual multiple flash operation procedures

(Applicable to all cameras)

Speedlights which can serve as a slave flash unit

SB-80DX, SB-30, SB-29s/29, SB-28/28DX, SB-27, SB-26, SB-25, SB-24, SB-22s, SB-22, SB-20, SB-17, SB-16, SB-15, SB-14, SB-11, SB-140

Usable remote cords (optional) (See page 77.)

Sync Cord SC-11/SC-15

TTL Remote Cord SC-17

TTL Multi-Flash Sync Cord SC-18/SC-19

- 1 Use the sync terminal for connecting the SB-27 with other Speedlight slave units via optional sync cords.

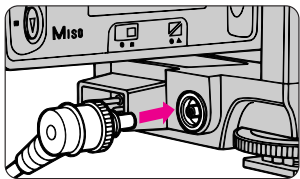

- 2 Set Manual (M) Flash mode on each Speedlight.
- 3 Setting up a master flash unit and slave unit(s)
Set the zoom-head position and the flash-to-subject shooting distance on the master flash unit. Set the slave unit(s) in the same way.
- 4 Follow the same procedures as in Manual (M) Flash mode.
For guide numbers for each light output in Manual (M) mode, see page 46.

Setting Forced TTL and Forced A modes

(Applicable to all camera groups)

- Select Forced TTL mode when using the SB-27 as a slave unit(s) in multiple flash operation. (See page 63.) Please refer to “NOTE: Using the SB-27 as a slave flash unit” on page 64.
- Select Forced A (non-TTL Auto Flash) mode when you intentionally want easy exposure compensation with cameras in Groups I thru VI.

Setting and canceling Forced TTL mode/Forced A mode

■ Forced TTL mode

1

Set the camera setting switch (inside the SB-27's battery chamber) to .

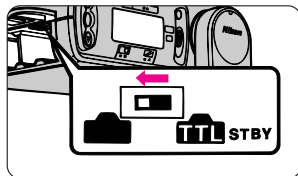

2

Switch the flash mode selector from OFF to AUTO while holding down the "ZOOM" button.

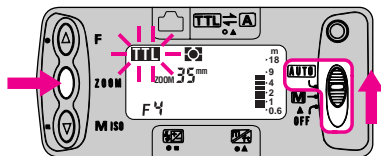

—The  indicator in the LCD panel blinks to indicate that the SB-27 is in Forced TTL mode.

Setting Forced TTL and Forced A modes

(Applicable to all camera groups)

■ Forced A mode

- 3 Switch the flash mode selector from OFF to AUTO while holding down the "ZOOM" button.

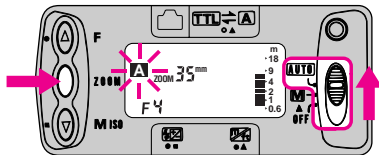

The **A** (non-TTL Auto Flash) indicator in the LCD panel blinks to indicate that the SB-27 is in Forced A mode.

NOTE

- In non-TTL Auto Flash mode, choose aperture-priority auto (A) or manual (M) exposure mode, and when the same aperture is set on both the SB-27 and the camera, correct exposure is achieved.
- The subject will be overexposed if you set a larger (lower f-number) aperture on the camera than on the SB-27. Conversely, the subject will be underexposed if you set a smaller (higher f-number) aperture on the camera than on the SB-27.

■ Canceling Forced TTL and Forced A modes

- 4 Switch the flash mode selector from OFF to AUTO while holding down the "ZOOM" button.

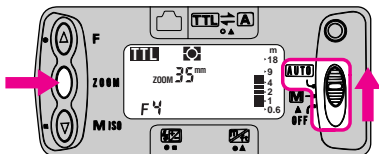

The **A** indicator in the LCD stops blinking and flash operation returns to normal TTL Auto Flash mode (for cameras in Groups I thru VI), and to non-TTL Auto Flash mode (for cameras in Group VII.)

Red-eye reduction control

(Cameras in Group I [except F5], F65-Series/N65-Series and Pronea 600i/6i)

When photographing people in dim light using a flash, the subject's eye may appear red in color pictures or white in B/W pictures, a phenomenon known as "red-eye" effect. Light from the camera's flash reflects off the retina of the eye through the pupil and back into the camera's lens.

With cameras in Group I (except F5), F65-Series/N65-Series and Pronea 600i/6i, the SB-27's red-eye reduction lamp lights up for approx. 1 sec. before the flash fires and the picture is taken.

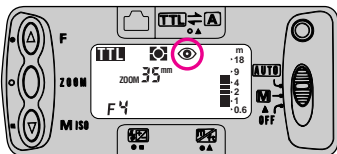

- When red-eye reduction or red-eye reduction in slow-sync is set on-camera, the red-eye reduction control indicator ● appears in the SB-27's LCD panel.
- You cannot set the red-eye reduction function from the SB-27. Refer to your camera's Instruction Manual for details on setting the red-eye reduction function.

Other information

This section covers troubleshooting procedures, optional accessories, tips on Speedlight care, and contains a glossary of terms.

Using an external power source

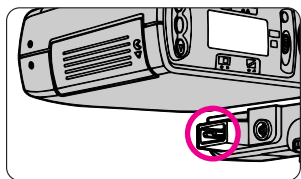

Nikon DC Unit SD-7 or SD-8/8A can be used as an optional external power source supplying long and stable power, increasing the number of flash firings, and providing faster recycling time. To use a DC Unit, connect its power cord to the SB-27's external power source terminal.

—Even when powered with a DC Unit, the SB-27 still requires batteries inside the flash unit. Do not remove the batteries.

Available external power source (optional) See page 78.

Batteries		Min. recycling time* (approx.)	No. of flash/ recycling time (approx.)
External power source SD-7	C-type alkaline-manganese (x 6)	2.5 sec.	500 times/2.5–30 sec.
External power source SD-8/8A**	AA-type alkaline-manganese (x 6)	2.5 sec.	350 times/2.5–30 sec.
	AA-type NiCd (x 6)	1.8 sec.	150 times/1.8–30 sec.

*Data measured with fresh batteries.

**Install the same type of batteries in the SB-27 and SD-8/SD-8A.



Use only Nikon-approved external power source units.

Using external power sources other than those specified by Nikon may cause unexpected damage to the Speedlight.

Connecting the SB-27 to a camera with a sync cord

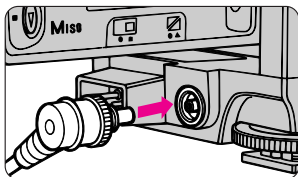

To connect the SB-27 to a camera with a sync cord, connect the sync cord to the SB-27's sync terminal.

Usable sync cords SC-11, SC-15 (optional) See page 77.

To connect the SB-27 to a camera without a sync terminal, use Sync Terminal Adapter AS-15 (optional).

-  When connected by a sync cord, the SB-27's normal functions are inoperative, except for flash firing. The SB-27 provides neither automatic sync speed setting nor ready-light viewfinder indication.
- Use optional TTL Remote Cord SC-17 or SC-24 when using the SB-27 off the camera in order to maintain all functions. (See page 77.)

Warning indications on the camera

The flash ready-light in the camera's viewfinder blinks in the following cases. (No indication appears in the SB-27's LCD panel.)



F90X/N90s viewfinder display shown

■ **F-501/N2020, F-401s/N4004s, F-401/N4004, F-301/N2000, FA, FE2, FG, and Nikonos V**

In TTL mode, the flash ready-light blinks to indicate that the ISO film speed of the film in use is higher than the ISO setting in the SB-27's LCD panel, (or lower also in the case of the FA camera).

■ **FA, FE2, FG, and Nikonos V**

In TTL mode, the flash ready-light blinks when the shutter speed is set to either M90, M250, or B setting.

■ **FM3A, New FM2**

The flash ready-light blinks when the shutter speed set is faster than the flash sync speed.







■ **Any camera having an accessory shoe capable of TTL Auto Flash operation**

The flash ready-light blinks when the shutter release button is pressed halfway, indicating that the SB-27 has not been securely mounted on the camera.

■ **F90X/N90s, F90-Series/N90, F70-Series/N70, F65-Series/N65-Series, F60-Series/N60, F50-Series/N50, F-601/N6006, F-601M/N6000, F-401x/N5005, F-401s/N4004s, and F-401/N4004**

The flash ready-light (or flash recommended/ready light) blinks or lights up (in some camera models) to recommend the use of flash.

Troubleshooting

Warning indicator	Cause	Action to be taken	Ref. page
No  indicator appears.	<ul style="list-style-type: none"> Batteries are not correctly installed. Battery power is weak. Battery contacts inside the battery chamber are contaminated. 	<ul style="list-style-type: none"> Re-install batteries with correct "+" and "-" directions. Install new batteries. Clean the battery contacts. 	P. 11
Power turns OFF.	<ul style="list-style-type: none"> Battery power is exhausted. Camera setting switch is set to  for cameras in Group VII. 	<ul style="list-style-type: none"> Replace the batteries with fresh ones. Set the camera setting switch to . 	P. 11, 18 P. 13
No indicator bars appear.	<ul style="list-style-type: none"> Built-in bounce flash adapter is used for bounce flash operation or not correctly set into place. 	<ul style="list-style-type: none"> Fold the diffuser card back into the unit. 	P. 52
M above the ZOOM blinks. (for cameras in Group I and II)	<ul style="list-style-type: none"> Auto zoom-head positioning is canceled. 	<ul style="list-style-type: none"> Resume auto zoom-head positioning. 	P. 20
No  indicator lights up (for cameras in Group I)	<ul style="list-style-type: none"> A lens other than a Nikkor lens with built-in CPU is mounted. Flash mode is set to Standard TTL Flash. 	<ul style="list-style-type: none"> Mount a Nikkor lens with built-in CPU. Press the "M" button until the flash mode indicator  appears. 	P. 24 P. 24
 indicator blinks and exposure compensation value lights up (for cameras in Group I).	<ul style="list-style-type: none"> Flash has fired at full output but the light may have been insufficient. 	<ul style="list-style-type: none"> Reconfirm the flash shooting distance range, move closer to the subject, or select a wider aperture, and then reshoot. 	P. 40
 blinks	<ul style="list-style-type: none"> Lens aperture is not set to its minimum (highest f-number). 	<ul style="list-style-type: none"> Set the lens aperture to its minimum, or set the exposure mode to A or M. 	N/A

Optional accessories

Sync Cord SC-11 and SC-15

Use Sync Cord SC-11 or SC-15 when using the SB-27 off-camera or mounting the SB-27 on a camera without an accessory shoe, or performing Multiple Flash operation in manual (M) mode with the SB-27. The SC-11 is approx. 25 cm (9.8 in.) long; the SC-15 is approx. 1m (3.2 ft.) long.

TTL Remote Cord SC-17 and SC-24

Use Remote Cord SC-17 for TTL Auto Flash operation when using the SB-27 off-camera. The SC-17 comes with one tripod socket and two TTL multiple flash terminals. The SC-17 is approx. 1.5 m (4.9 ft.) long. Use the SC-24 when the DW-20 or DW-21 is mounted on the F4-Series camera.

TTL Multi-Flash Sync Cord SC-18 and SC-19

Use Multi-Flash Sync Cord SC-18 or SC-19 to connect the flash unit to the multiple flash terminal of the SC-17 or AS-10 for TTL multiple flash operation. The SC-18 is approx. 1.5 m (4.9 ft.) long, and the SC-19 is approx. 3 m (9.8 ft.) long.

TTL Multi-Flash Adapter AS-10

Use multi-flash adapter AS-10 when using more than three flash units for TTL multiple flash operation, or if the slave flash units are not equipped with multiple flash terminals. The AS-10 comes with one tripod socket and three TTL multiple flash terminals.

Sync Terminal Adapter AS-15

Use Sync Terminal Adapter AS-15 to connect the SB-27 with cameras with no sync terminal provided.

Wireless Slave Flash Controller SU-4

Useful for multiple flash photography, the SU-4 features a built-in, movable light sensor and an accessory shoe for attachment of a slave Speedlight. The SU-4's light sensor not only triggers the slave unit to fire in unison with the master flash, but controls the flash duration of the slave unit in sync with the master unit to provide TTL, non-TTL, or Manual operation.

TTL Flash Unit Coupler AS-17 for F3-Series cameras

Dedicated adapter for F3-Series cameras providing TTL flash operation with Nikon Speedlights such as SB-27 and SB-28 featuring ISO-type mounting foot (not designed for F3).

DC Unit SD-7

An external power source that increases the number of flash firings, and provides faster recycling time. The SD-7 uses six C-type alkaline-manganese batteries or six C-type NiCd batteries.

DC Unit SD-8/8A

A compact and lightweight external power source that increases the number of flash firings and provides faster recycling time. The SD-8/8A uses six AA-type alkaline-manganese batteries or six AA-type NiCd batteries.

Modulate Remote Control Set ML-2

The ML-2 consists of a receiver and transmitter set that enables automatic remote control using modulated light for multiple flash operation with more than two flash units.

Tips on Speedlight care

■ Avoid physical shocks

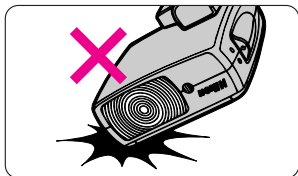

Do not drop or hit the SB-27 against a hard surface.

—This may damage the precision mechanism.

■ Never disassemble

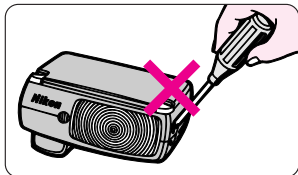

Never disassemble or repair the SB-27 when it is damaged or malfunctioning.

—The SB-27 houses high-voltage circuitry which is highly dangerous.

■ Keep the SB-27 away from water

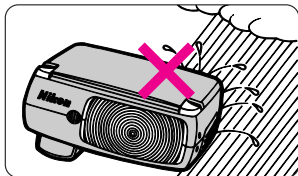

Do not expose the SB-27 to rain or water as it is not waterproof.

—If water gets inside the SB-27, the internal parts may corrode, resulting in high repair costs if repair is at all possible.

Tips on Speedlight care

■ Notes on cleaning

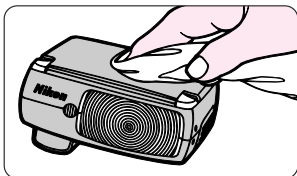

Use a blower brush to remove dirt and dust from the SB-27 and clean lightly with a soft, clean cloth .

—Do not use commercial cleaners containing active agents such as paint thinner or benzene.

■ Maintenance

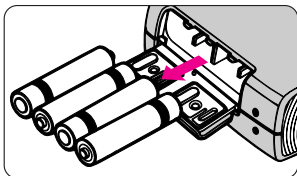

When not using the SB-27 for prolonged period of time (more than two weeks), be sure to remove the batteries before storage. Take the SB-27 out about once a month, insert the batteries and fire the unit several times to prevent the condenser from deteriorating. Finally make sure the ready-light is on, before turning the power off and removing the batteries.

■ Storage

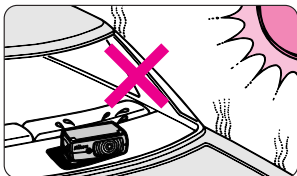

Store the SB-27 in a cool, dry place to prevent mold. Also keep it away from chemicals such as camphor or naphthalene. Avoid exposing the SB-27 to magnetic waves (TV or radio) and high temperatures (e.g. car interiors or heaters.)

Notes on batteries

Battery power tends to weaken as the temperature drops; it also drains off slowly when not in use for a long period of time, and recovers after a short break following intensive use. Be sure to replace the batteries with a fresh set if you notice any delays in recycling.

- Do not mix battery brands or types, as battery performance differs with each brand.
- When installing the battery, turn the SB-27's power OFF and make sure that the battery terminals \oplus \ominus are correctly oriented.
- When replacing batteries, be sure to replace all the batteries at the same time. Always use fresh batteries of the same brand and type.

—Wrong battery usage may shorten battery life or cause malfunction.

- Do not disassemble, short-circuit or heat batteries. Do not dispose of batteries by burning, as explosions may result.
- If the SB-27 is not in use for more than two weeks, remove the batteries from the flash unit and keep them in a cool, dry place below 20°C (68°F).

Warning:

- Batteries shall not be exposed to excessive heat such as sunshine, fire or the like.
- Dry batteries shall not be subjected to charging.

About NiCd batteries

Please note the following points when using NiCd batteries.

- NiCd batteries feature a faster recycling time and greater efficiency at low temperatures than alkaline-manganese batteries.
 - Other performance data differs depending on battery conditions, and whether or not batteries are fresh or fully charged.
- When charging NiCd batteries, be sure to use the battery charger specified by the battery maker and read the instruction manual thoroughly.
- Charging should be made in an ambient temperature ranging from 10°C to 30°C (50°F to 86°F).
- Do not recharge NiCd batteries with the reverse terminals connected or before the batteries have cooled off.
- Overcharging and excessive use may shorten battery life. Do not overcharge and be sure to turn the power OFF when not using your Speedlight.
- If NiCd batteries do not last as long as they should after being properly charged, they are approaching the end of their life. Replace them with new ones.

Using the SB-27 in low temperatures

As the temperature drops, battery performance becomes degraded. When taking photographs in low temperatures, use fresh batteries, and keep a set of spares in a warm place (e.g. a coat pocket), or use fully-charged NiCd batteries. The SB-27 will not fire if weak batteries are used in low temperatures.

- Battery power will recover when the temperature goes back to normal. Avoid warming or cooling the batteries too quickly as this may cause battery voltage to become unstable.

Glossary of terms

1/300 TTL High-Speed Sync Flash	84
3D Multi-Sensor Balanced Fill-Flash	84
Autofocus assist illumination	84
Automatic Balanced Fill-Flash with TTL Multi Sensor	84
Bounce flash operation	85
Catchlight	85
Center-Weighted/Spot Fill-Flash	85
Flash exposure compensation	85
Flash shooting distance range	85
Front-curtain sync flash	86
Guide Number	86
Matrix Balanced Fill-Flash	86
Monitor Preflash	86
Multi-Sensor Balanced Fill-Flash	87
Multiple flash operation	87
Non-TTL auto flash	87
Programmed TTL Auto Flash	87
Rear-curtain sync flash	87
Red-eye reduction	88
Standard TTL Flash	88
Sync shutter speed	88

1/300 TTL High-Speed Sync Flash

The F5's sync shutter speed can be set to 1/300 sec. using a custom function setting. This is available with the SB-27 set to AUTO (TTL) and the camera's exposure mode set to S or M. In this case the SB-27's guide number is approx. 14 (at the 35mm zoom-head position, ISO 100: for m).

In P or A mode, 1/300 TTL High-Speed Sync Flash does not work and shutter speed is automatically set to 1/250 sec.

(Applicable to F5)

3D Multi-Sensor Balanced Fill-Flash

This mode automatically controls flash output so as to keep both subject and background perfectly exposed.

The SB-27 fires a series of nearly invisible preflashes or Monitor Preflash. These preflashes are detected by the TTL multi-sensor (5-segment sensor) in Group I cameras and the data is then integrated with distance information from D-type Nikkor lenses and other exposure data to determine the optimal flash shooting distance range and light output level for balanced fill-flash exposure. This is especially effective with scenes that include: (1) a mirror, white wall or other highly reflective surface, (2) unwanted obstacle(s) in front of the subject.

(Applicable to F5, F100, F90X/N90s, F90-Series/N90, F80-Series/N80-Series, F70-Series/N70)

Autofocus assist illumination

Allows you to autofocus in dim light or in the dark with Nikon AF cameras. When you press the shutter release button halfway, the AF illuminator automatically turns ON to give contrast to a dark subject, thus enabling the camera's autofocus system to function.

(Applicable to all Nikon AF cameras)

Automatic Balanced Fill-Flash with TTL Multi Sensor (3D multi-sensor balanced fill-flash and multi-sensor balanced fill-flash)

With D-type AF Nikkor lenses, 3D multi-sensor balanced fill-flash is performed, whereby the SB-27 fires a series of weak preflashes (Monitor Preflash) that are detected by the camera's TTL Multi Sensor, then analyzed for brightness and contrast along with Distance Information from the D-type AF Nikkor lens. The flash output level is automatically compensated so that both flash output and ambient light are perfectly balanced.

With non-D-type AF Nikkor lenses, Multi-Sensor balanced Fill-Flash, which offers the same output control system minus Distance Information, is performed.

These flash modes are effective in scenes with highly reflective objects such as a mirror or a white wall, and scenes with very dark backgrounds.

(Applicable to F5, F100, F90X/N90s, F90-Series/N90, F80-Series/N80-Series, F70-Series/N70)

Bounce flash operation

Bounce the light off the ceiling or walls to illuminate the subject indirectly, softening shadows and producing more natural portraits. The SB-27 comes with a built-in wide flash adapter for this purpose.
(Applicable to all camera groups)

Catchlight

By using the SB-27's built-in diffuser and bouncing the light off the ceiling, you can create a "catchlight" which softens harsh shadows caused by bounced light, resulting in more natural portraits.
(Applicable to all camera groups)

Center-Weighted/Spot Fill-Flash

This mode operates with Center-Weighted or Spot metering. These metering systems measure the background brightness and control the flash, providing less light than with Matrix Balanced Fill-Flash. Recommended with non-AF Nikkor lenses in place of Matrix Balance Fill-Flash, which cannot be used.
(Applicable to F5, F4-Series, F100, F90X/N90s, F90-Series/N90, F70-Series/N70, F60-Series/N60, F50-Series/N50, F-801s/N8008s, F-801/N8008, F-601/N6006, F-601M/ N6000, F-401x/ N5005)

Flash exposure compensation

In combination with on-camera exposure compensation, you can manually adjust the amount of flash output when using a Speedlight in AUTO flash mode. To achieve correct exposure with a large white background, a small subject in the center of the viewfinder, or a subject close to the edge of the frame, underexpose; overexpose if your subject is positioned against an "infinity" background.
(Applicable to all camera groups except group VII)

Flash shooting distance range

Your subject must be within acceptable flash shooting distance range in order to receive sufficient illumination from the flash. This range varies depending on the aperture and ISO film speed. In flash operation, make sure that the subject is within flash shooting distance range.
(Applicable to all camera groups)

Front-curtain sync flash

In normal flash synchronization, the Speedlight fires at the beginning of the exposure. The flash therefore fires just after the front-curtain opens. Rear-curtain sync flash is also possible with cameras featuring a rear-curtain flash sync mode set on the camera. *(Applicable to all camera groups)*

Guide Number

This number refers to the maximum light output in units of GN [ISO 100 . m(ft)]. A guide number is given to help determine the correct aperture or f/stop value, or flash shooting distance using the following equation.

$$f/\text{stop (aperture)} = \frac{\text{guide number}}{\text{flash-to-subject distance (m)}}$$

$$\text{flash-to-subject distance (m)} = \frac{\text{guide number}}{f/\text{stop (aperture)}}$$

(Applicable to all camera groups)

Matrix Balanced Fill Flash

This mode automatically controls flash output so as to keep both subject and background perfectly exposed.

The camera's Matrix Metering System determines the correct exposure based on ambient light. Flash illumination brightens the main foreground subject but does not overpower the background. *(Applicable to F4-Series, F-801s/N8008s, F-801/N8008, Pronea 600i/6i, F-601/N6006, F-601M/N6000, F65-Series/N65-Series, F60-Series/N60, F50-Series/N50, and F-401X/N5005)*

Monitor Preflash

In Automatic Balanced Fill-Flash with TTL Multi Sensor mode, immediately after you depress the shutter release button and before the shutter is activated, the SB-27 fires a brief series of nearly invisible preflashes known as Monitor Preflash. These preflashes are detected by the camera's TTL Multi Sensor, then analyzed for brightness and contrast ensuring optimal exposure. *(Applicable to F5, F100, F90X/N90s, F90-Series/N90, F80-Series/N80-Series, F70-Series/N70)*

Multi-Sensor Balanced Fill-flash

This mode automatically controls flash output so as to keep both subject and background perfectly exposed.

The SB-27 fires a series of nearly invisible preflashes or Monitor Preflash, which are detected by the TTL multi-sensor (5-segment sensor) in Group I cameras to help determine the best exposure for both subject and background. This method is most effective in scenes that include: (1) a mirror, white wall or other highly reflective surface, and (2) a subject positioned against an “infinity” background (empty sky, clouds, etc.) With non-D-type AF Nikkor lenses, Multi-Sensor Balanced Fill-Flash will operate.

(Applicable to F5, F100, F90X/N90s, F90-Series/N90, F80-Series/N80-Series, F70-Series/N70)

Multiple flash operation

Flash operation using more than one speedlight to eliminate harsh shadows or to illuminate a distant background.

(Applicable to all camera groups)

Non-TTL auto flash

The light output is automatically controlled to match the flash-to-subject distance measured by the Speedlight's light sensor.

(Applicable to all camera groups)

Programmed TTL Auto Flash

Simply set the lens to its minimum aperture (highest f-number), and the camera automatically controls the aperture according to the ISO film speed.

(Applicable to F-501/N2020, F-401s/N4004s, F-401/N4004, F-301/N2000)

Rear-curtain sync flash

In this case, the flash fires at a later stage of the exposure, just before the rear shutter curtain starts to close. This is effective for highlighting subject movement at a slow shutter speed. This method turns available light into a stream of light that follows the flash-illuminated moving subject. In front-curtain sync flash, available light turns into a stream of unnatural light that appears before the flash-illuminated moving subject.

(Applicable to F5, F100, F90X/N90s, F90-Series/N90, F80-Series/N80-Series, F70-Series/N70, F65-Series/N65-Series, F-601/N6006, F-601M/ N6000, Pronea 600i/6i)

Red-eye reduction

The SB-27's red-eye reduction lamp lights up for approx. 1 sec. before the flash fires. This prevents eyes from appearing red in color pictures or white in B/W pictures, a phenomenon known as "red-eye" effect.

(Applicable to F100, F90X/N90s, F90-Series/N90, F80-Series/N80-Series, F70-Series/N70, F65-Series/N65-Series, Pronea 600i/6i cameras)

Standard TTL Flash

You can manually select a flash output level so that the main subject is correctly exposed regardless of the background brightness. Otherwise the main subject may appear unduly emphasized against the background.

(Applicable to F5, F4-Series, F100, F90X/N90s, F90-Series/N90, F80-Series/N80-Series, F70-Series/N70, F-801s/N8008s, F-801/N8008, F-601/N6006, F-601M/N6000, F-501/N2020, F-401s/N4004s, F-401/N4004, F-301/N2000, Pronea 600i/6i, FM3A, FA, FE2, FG, and Nikonos V)

Sync shutter speed

This refers to the highest available shutter speed for flash synchronization; although slower speeds can be used, higher speeds cannot.

(Applicable to all camera groups)

Specifications

Electronic construction	Automatic Insulated Gate Bipolar Transistor (IGBT) and series circuitry.				
Angle of coverage	Horizontal position				
	Angle of coverage		Vertical	Horizontal	
	Covering the picture angle of 24mm lens		60°	78°	
	Covering the picture angle of 28mm lens		53°	70°	
	Covering the picture angle of 35mm lens		46°	60°	
	Covering the picture angle of 50mm lens		36°	46°	
	Vertical position				
	Angle of coverage		Vertical	Horizontal	
	Covering the picture angle of 35mm lens		78°	60°	
	Covering the picture angle of 50mm lens		60°	46°	
Covering the picture angle of 70mm lens		46°	36°		
Guide number (at ISO 100: for m/ft)	(at 20°C/68°F)				
	Light Output	Zoom-head position			
		24mm	28mm (normal)	35mm	50mm
	1/1 (full)	25/82	27/89	30/98	34/112
	1/2	17.7/58	19/62	21.2/69	24/79
	1/4	12.5/41	13.5/44	15/49	17/56
	1/8	8.8/29	9.5/31	10.5/34	12/39
	1/16	6.2/20	6.7/22	7.4/24	8.5/28
For Guide numbers for 1/300 TTL High-Speed Sync Flash in AUTO flash mode (F5 camera only), see page 40.					
Flash head	The flash head rotates from the horizontal to the vertical position along a 180° arc.				
Flash mode selector	OFF / M / AUTO <ul style="list-style-type: none"> • Power turns ON when set to "M" or "AUTO" position. • Standby function works when set to "M" or "AUTO" position (set camera setting switch to ); power automatically turns OFF after approx. 80 seconds when both SB-27 and camera are not in use. 				

Specifications

Flash mode selector	<ul style="list-style-type: none"> • AUTO mode: TTL Auto Flash operation possible with cameras in Groups I thru VI (Monitor Preflash is available exclusively with cameras in Group I using a Nikkor lens with built-in CPU). Non-TTL Auto Flash operation possible with cameras in Groups I thru VII when camera setting switch is set to  (usable apertures f/2.8, f/4, f/5.6, and f/8 at ISO 100.) • M mode: Manual flash operation possible with cameras in all groups. Light output amount variable from 1/1(full), 1/2, 1/4, 1/8 to 1/16 output. 		
Power source	Four AA-type alkaline-manganese (1.5V), lithium (1.5V), NiCd (rechargeable) (1.2V), or Ni-MH (rechargeable) (1.2V) penlight batteries		
External power source (optional)	DC Unit SD-7: C-type alkaline-manganese (x 6) DC Unit SD-8/8A: AA-type alkaline-manganese (x 6) or AA-type NiCd batteries (x 6)		
Number of flashes and recycling time	Batteries installed in the SB-27		
	Batteries	Min. recycling time (approx.)	No. of flash/recycling time (approx.)
	AA-type alkaline manganese	5 sec. (using fresh battery)	140 times/5-30 sec.
	AA-type NiCd	3.5 sec. (using fresh battery)	60 times/3.5-30 sec.
	Manual full output without use of AF assist illuminator LED, and zoom operation. Above data may vary according to battery brands or performance.		
Red-eye reduction	A red-eye reduction lamp lights up for approx. 1 sec. before the flash fires. (Setting is only possible on the cameras in Group I (except F5) and Pronea 600i/6i)		
Rear-curtain sync flash	Possible with cameras featuring rear-curtain flash sync mode set on the camera.		
AF assist illumination	Automatically lights up to emit LED beam toward subject when performing autofocus in dim light or in the dark with Nikon AF cameras.		

Ready-light	<ul style="list-style-type: none"> • Lights up when recharging is completed. • AUTO mode: Blinks for approx. 3 seconds when flash fires at its maximum output but the light may have been insufficient.
Open-flash button	<ul style="list-style-type: none"> • Performs test firing. • Turns the SB-27 ON again after it has been turned OFF by the standby function.
Built-in diffuser card	Used in bounce flash operation to create catchlight in subject's eyes.
Safety lock system	Automatically inserts the mount pin into the locking hole in the camera's accessory shoe to prevent the SB-27 from detaching. (Not provided with all cameras).
Measurement system in LCD panel	Interchangeable meters (m) or feet (ft) measurement system by pressing the "F" button and flash mode selector simultaneously.
Flash duration (approx.)	1/1000 sec. at 1/1 (full) output 1/1100 sec. at 1/2 output 1/2500 sec. at 1/4 output 1/4200 sec. at 1/8 output 1/6700 sec. at 1/16 output
Other features	External power source terminal / sync terminal provided
Dimensions (WxHxD)	Approx. 107 x 70 x 97mm (4.2 x 2.8 x 3.8 in.) (horizontal position)
Weight (without batteries)	Approx. 340g (12 oz)
Accessories provided	Soft case SS-27

All performance data are for normal-temperature operation (20°C/68°F). Specifications and design are subject to change without notice.

No reproduction in any form of this manual, in whole or in part (except for brief quotation in critical articles or reviews), may be made without written authorization from NIKON CORPORATION.

Nikon

NIKON CORPORATION

FUJI BLDG., 2-3, MARUNOUCHI 3-CHOME,
CHIYODA-KU, TOKYO 100-8331, JAPAN

Free Manuals Download Website

<http://myh66.com>

<http://usermanuals.us>

<http://www.somanuals.com>

<http://www.4manuals.cc>

<http://www.manual-lib.com>

<http://www.404manual.com>

<http://www.luxmanual.com>

<http://aubethermostatmanual.com>

Golf course search by state

<http://golfingnear.com>

Email search by domain

<http://emailbydomain.com>

Auto manuals search

<http://auto.somanuals.com>

TV manuals search

<http://tv.somanuals.com>