

Nikon Riflescope Monarch/Titanium

6.5-20x44 A0
5.5-16.5x44 A0
4-12x40 A0
3.3-10x44 A0
3.5-10x50
1.5-4.5x20
2.5-8x28
6x42
3-9x40
2-7x32
4x40
2x20

Instruction Manual

Congratulations on your choice of a Nikon RIFLESCOPE. Your new scope is the finest example of Nikon's rugged and durable construction and precision bright optics; important qualities for a serious shooter's riflescope.

Whether you use your scope for hunting or for target shooting, the procedure for mounting is identical. You should acquire a set of high quality steel mounting rings which have a standard diameter of 25.4 mm (1inch). Follow the ring manufacturer's instructions for mounting procedures. After mounting the scope on your rifle, follow the procedures for reticle alignment.

Caution

- (1) Do not look at the sun through the riflescope. It will permanently damage your eye. This precaution applies to all optical devices such as cameras and binoculars.
- (2) The riflescope is effectively sealed against moisture and dust. You may use your scope safely either in the rain or in dusty climates. To preserve the appearance of the scope, we suggest that it be dried and cleaned prior to storage. Use a soft cloth for cleaning metal surfaces and use photographic lens tissue to clean the scope's lenses.

When setting the reticle for hunting, you should determine your standard range and then adjust the reticle based upon that target distance. For targets which vary from the standard distance you may simply adjust the position of the reticle in relation to your target, or you may wish to use the procedure for trajectory compensation. It's up to your personal preference.

We hope that you will enjoy your new Nikon RIFLESCOPE for many years to come. Enjoy using it, and above all, always follow safe shooting procedures!

The product(s) described herein may be subject to export control regulations in the relevant country(ies). It (they) should not be exported without authorization of the exporting governmental authority if the regulations apply.

1. Nomenclature

- (1) Objective Lens
- (2) Eyepiece Lens
- (3) Elevation Adjustment
- (4) Windage Adjustment
- (5) Eyepiece Lock Ring
- (6) Eyepiece Adjustment
- (7) Power Index Dot
- (8) Power Scale
- (9) Power Selector Ring
- (10) Adjustable Objective Adjustment Ring
- (11) Adjustable Objective Distance Scale
- (12) Distance Index Dot
- (13) Adjustment Cap

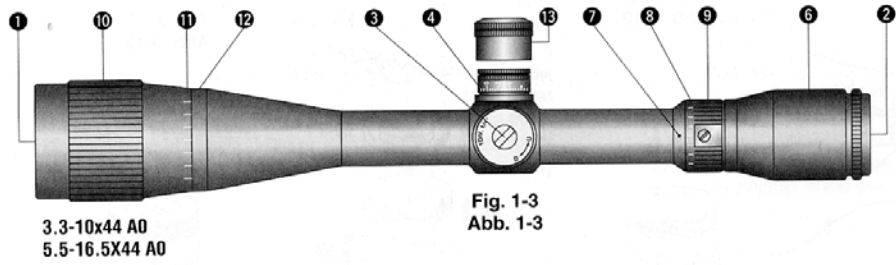
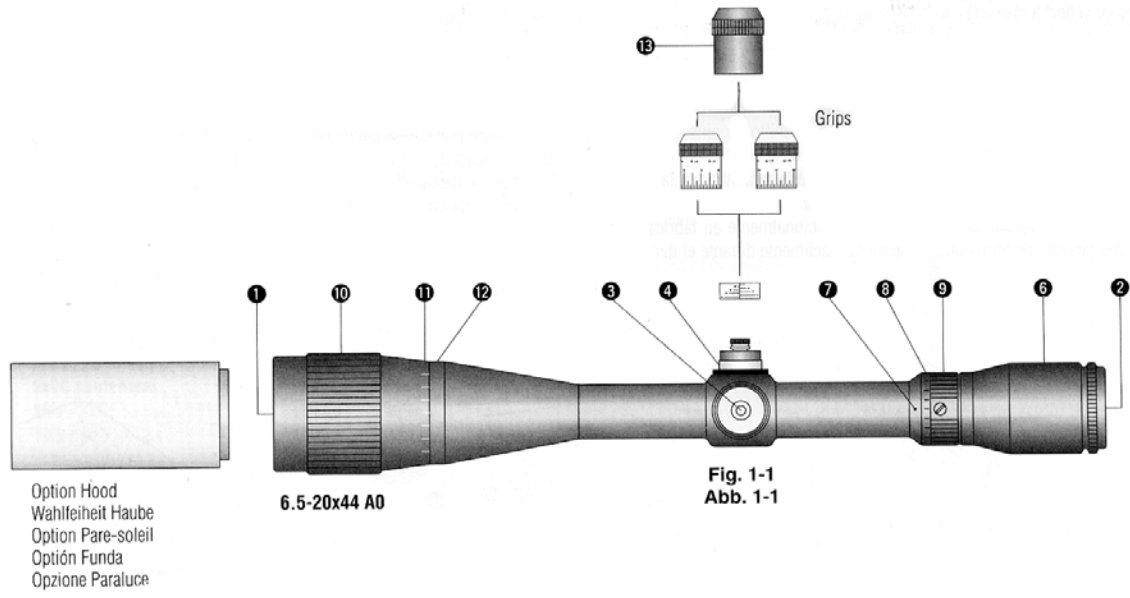

Grips for Elevation

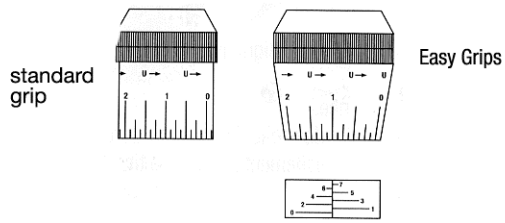

Fig. 1-2

Grip for Windage

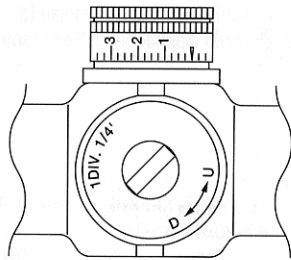
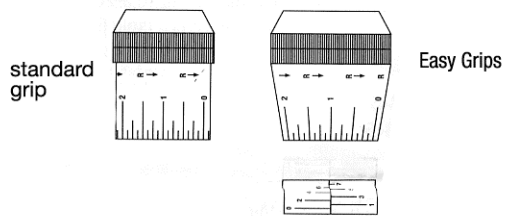

Fig. 1-4 **Magnified Figure of**
Abb. 1-4 **1.5-4.5x20,**

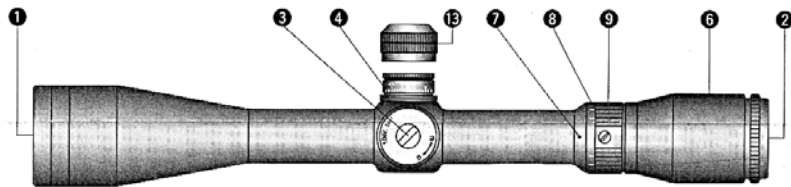

Fig. 1-5
Abb. 1-5

3.5-10x50
3-9x40
2-7x32
1.5-4.5x20
2.8-8x28

Magnified Figure of Hand turn Grip
Vergrößerte Darstellung des
Handdrehgriffs
Schéma agrandi de la poignée à
rotation manuelle

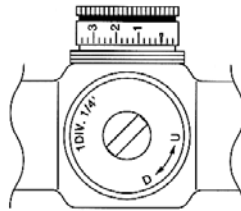

Fig. 1-7
Abb. 1-7

Ilustracion ampliada del cilindro de
ajuste manual
Figura ingrandita dell'impugnatura
a rotazione manuale

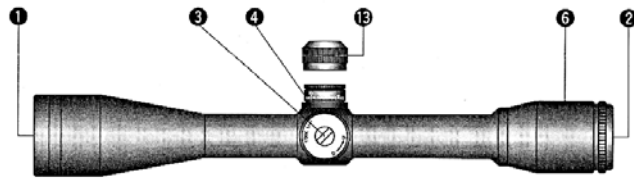

Fig. 1-9
Abb. 1-9

6x42
4x40

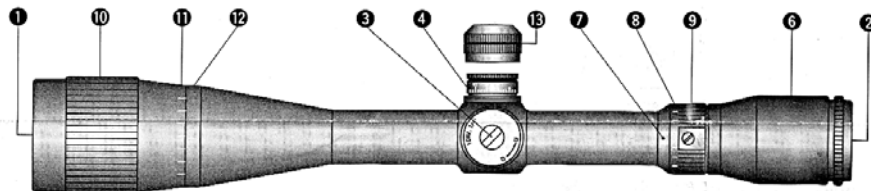

Fig. 1-6
Abb. 1-6

4-12x40 A0

Magnified Figure of 1.5-4.5x20, 4x40, 2x20
Hand turn Grip
Vergrößerte Darstellung des 1,5-4,5x20,
4x40, 2x20 Handdrehgriffs
Schéma agrandi de la poignée à
rotation manuelle 1,5-4,5x20, 4x40, 2x20

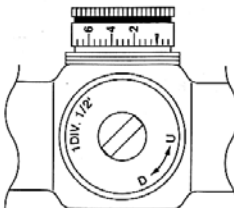

Fig. 1-8
Abb. 1-8

Ilustracion ampliada del cilindro de
ajuste manual 1,5-4,5x20, 4x40, 2x20
Figura ingrandita dell'impugnatura
a rotazione manuale 1,5-4,5x20,
4x40, 2x20

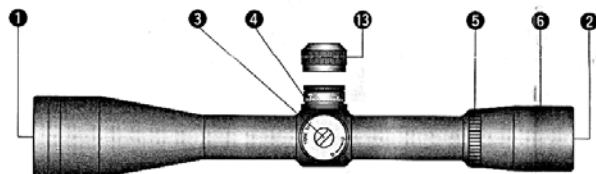

Fig. 1-10
Abb. 1-10

2x20

2. Specifications

Model	6.5-20x44 A0 MONARCH	3.3-10x44 A0 MONARCH/ TITANIUM	3.5-10x50 MONARCH	4-12x40 A0 MONARCH	5.5-16.5x44 A0 MONARCH/ TITANIUM	3-9x40 MONARCH
Actual Magnification	6.5x-19.5x	3.3x-10x	3.5x-10x	4x-12x	5.5x-16.5x	3x-9x
Objective Diameter	(mm) (in) 44 1.73	44 1.73	50 1.97	40 1.57	44 1.73	40 1.57
Exit Pupil	(mm) (in) 6.8-2.2 0.27-0.09	13.3-4.4 0.52-0.17	14.3-5 0.56-0.20	10-3.3 0.39-0.13	8-2.7 0.31-0.11	13.3-4.4 0.52-0.17
Eye Relief * * * * *	(mm) (in) 88.9-78.7 3.5-3.1	91.4-91.4 3.6-3.6	99.1-96.5 3.9-3.8	91.4-86.4 3.6-3.4	81.3-76.2 3.2-3.0	91.4-88.9 3.6-3.5
Field of View at 100yds.	(m) (ft) 4.9-1.6 16.1-5.4	9.3-3.1 30.4-10.1	7.8-2.7 25.5-8.9	7.8-2.6 25.6-8.5	5.8-2.0 19.1-6.4	10.3-3.4 33.8-11.3
Tube Diameter	(mm) (in) 25.4 1	25.4 1	25.4 1	25.4 1	25.4 1	25.4 1
Objective Tube Dia.	(mm) (in) 53 2.09	53 2.09	57.5 2.26	52 2.05	53 2.09	47.3 1.86
Length	(mm) (in) 375 14.8	330 13.0	350 13.8	348 13.7	342 13.5	312 12.3
Weight	(g) (oz) 590 20.8	525/625 18.5/22.0	450 15.8	495 17.4	530/645 18.7/22.8	370 13.0
Adjustment Graduation	* (moa) 1/8:1 click 1/8:1 div	1/4:1 click 1/4:1 div	1/4:1 click 1/4:1 div	1/4:1 click 1/4:1 div	1/4:1 click 1/4:1 div	1/4:1 click 1/4:1 div
Maximum Internal Adjustment (Elevation & Windage)	* (moa) 38	50	45	45	40	55
Parallax Setting * *	(m) (yds) at least 45.72 ∞ at least 50-∞	at least 45.72 ∞ at least 50-∞	01.44 100	at least 45.72 ∞ at least 50-∞	at least 45.72 ∞ at least 50-∞	01.44 100
Outside Diameter of Eyepiece	(mm) (in) 41 1.61	41 1.61	41 1.61	41 1.61	41 1.61	41 1.61

Model	2-7x32 MONARCH	1.5-4.5x20 MONARCH	2.5-8x28EER MONARCH	6x42 MONARCH	4x40 MONARCH	2x20EER MONARCH
Actual Magnification	2x-7x	1.5x-4.5x	2.5x-8x	6x	4x	1.75x
Objective Diameter	(mm) (in) 32 1.26	20 0.79	28 1.10	42 1.65	40 1.57	20 0.79
Exit Pupil	(mm) (in) 16-4.6 0.63-0.18	13.3-4.4 0.52-0.17	11.2-3.5 0.44-0.14	7 0.28	10 0.39	11.4 0.45
Eye Relief * * * * *	(mm) (in) 99.1-91.4 3.9-3.6	94.0-88.9 3.7-3.5	304.8-762/228.6-330.2 12-30/9-13	88.9 3.5	88.9 3.5	670.6-266.7 26.4-10.5
Field of View at 100yds.	(m) (ft) 13.6-3.9 44.5-12.7	* * * * * 10.2-3.4/15.3-5.1 33.5-11.2/50.3-16.7	4.0-1.2 13.1-4.1	5.4 17.8	8.2 26.9	6.7 22
Tube Diameter	(mm) (in) 25.4 1	25.4 1	25.4 1	25.4 1	25.4 1	25.4 1
Objective Tube Dia.	(mm) (in) 39.3 1.55	25.4 1	35.5 1.40	49.3 1.94	47.3 1.86	25.4 1
Length	(mm) (in) 282 11.1	247 9.7	246 9.7	306 12.1	295 11.6	207 8.1
Weight	(g) (oz) 330 11.6	280 9.8	310 10.9	350 12.3	330 11.6	200 7.0
Adjustment Graduation	* (moa) 1/4:1 click 1/4:1 div	1/2:1 click 1/2:1 div	1/4:1 click 1/4:1 div	1/4:1 click 1/4:1 div	1/2:1 click 1/2:1 div	1/2:1 click 1/2:1 div
Maximum Internal Adjustment (Elevation & Windage)	* (moa) 70	120	40	80	120	120
Parallax Setting * *	(m) (yds) 91.44 100	* * * * * 45.72/68.58 50/75	91.44 100	91.44 100	91.44 100	91.44 100
Outside Diameter of Eyepiece	(mm) (in) 41 1.61	41 1.61	41 1.61	41 1.61	41 1.61	35.5 1.40

* moa=minute of angle



* * Nikon riflescopes are factory set to be parallax free at 100 yds (91.44 m). 6.5-20x44 A0, 3.3-10x44 A0, 4-12x40 A0 and 5.5-16.5x44 A0 allow free adjustment from 50 yds. up to infinite point. 1.5-4.5x20 is factory set to be parallax free at 50 yds (45.72 m) or 75 yds (68.58 m).

* * * 50 yds. for Diamond Reticle type 75 yds. for Nicoplex Reticle type.

* * * * at 50 yds./at 75 yds.

* * * * * (at minimum magnification)-(at maximum magnification)

ITEMS SUPPLIED

Body		1pc.
Eyepiece Cap		1pair
Objective Cap		
Grips (6.5-20x44 only)		2pcs.
Hex Key (6.5-20x44 only)		1pc.

Instructions

(1) Focusing

(1) Look through the eyepiece with your eye positioned about 10cm (4 in) away from the eyepiece lens (Fig. 3-1), and you will see the Nikoplex reticle (Fig. 3-2), the Crosshair with dot reticle (Fig. 3-3) or the Turkey Pro reticle (Fig. 3-4) the Crosshair reticle (Fig. 3-5) or the Miliradian Dot reticle (Fig. 3-6), or the BDC reticle (Fig. 3-7).

Be sure your eye is positioned within proper alignment and proper eye relief otherwise the view will "black out".

(2) Point the objective end of the scope at the sky (Do not point at the sun) or at a plain unpatterned wall.

Loosen the lock ring. (2x20 only)

Turn the eyepiece adjustment counter-clockwise and then turn it clockwise until the reticle appears sharp.

(2x20 only)

(3) Finally, without moving the eyepiece adjustment, turn the eyepiece lock ring as Fig. 3-8 to end so that the eyepiece adjustment will be firmly locked.

The lock ring must be firmly tightened to ensure an air-tight seal.

- 1) Lock Ring
- 2) Eyepiece Adjustment
- 3) Eye Relief

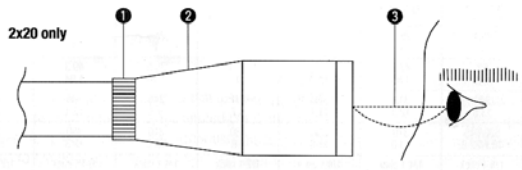
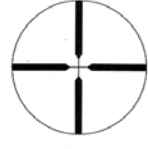
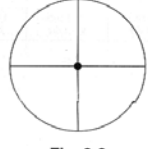

Fig. 3-1
Abb. 3-1



Nikoplex Reticle

Fig. 3-2
Abb. 3-2



Crosshair with Dot Reticle

Fig. 3-3
Abb. 3-3

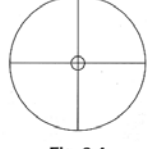

Turkey Pro Reticle (1.5-4.5x20 only)

Fig. 3-4
Abb. 3-4

- 1) Eyepiece Adjustment
- 2) Eye Relief

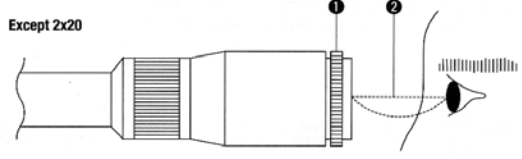

Except 2x20

Eyepiece Adjustment/
Okulareinstellung
Réglage d'oculaire
Dispositivo de ajuste del ocular
Regolatore oculare

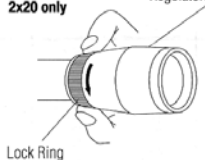

Lock Ring
Sperring
Bague de verrouillage
Anillo de bloqueo
Anello di blocco

Fig. 3-8
Abb. 3-8

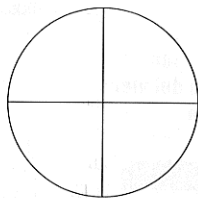

Crosshair Reticle (6.5-20x44 A0 only)

Fig. 3-5
Abb. 3-5

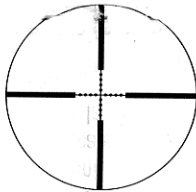

Miliradian Dot Reticle (3.3-10x44 A0 only)

Fig. 3-6
Abb. 3-6

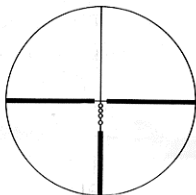

BDC Reticle (3-9x40, 3.5-10x50, 4-12x40,
6.5-2-x44, 5.5-16.5x44)

Fig. 3-7
Abb. 3-7

The reticle should be immediately crisp and clear to the quick glance.

(2) Magnification

- The Nikon Riflescope 6x42 has a fixed magnification of 6X, 4x40 of 4x, 2x20 of 1.75X.
- The Nikon Riflescope 3-9x40 has a variable magnification from 3 to 9X, 2-7x32 from 2 to 7X, 1.5-4.4x20 from 1.5 to 4.5X, 4-12x40 A0 from 4 to 16.5X, 3.5-10x50 from 3.5 to 10X, 3.3-10x44 A0 from 3.3 to 10X, 2.5-8x28 from 2.5 to 8x. To change powers, just rotate the power selector ring until the desired magnification appears adjacent to the power index dot.

(3) Adjustment of the riflescope

Sighting through the riflescope, align the rifle with your aiming point on the target and shoot a trial round. If the bullet does not hit the aiming point, adjust the elevation and windage, as follows:

- If the bullet hits under the aiming point, turn the elevation adjustment (counter-clockwise) in the direction of the arrow marked "U" for up as in Fig. 3-9. If the bullet hits high, turn adjustment (clockwise) in the direction of the arrow marked "D" for down.
- If the bullet hits to the right of the aiming point, turn the windage adjustment (clockwise) in the direction of the arrow marked "L" for left as

- in Fig. 3-10. If the bullet hits to the left of the aiming point, turn adjustment (counter-clockwise) in the direction of the arrow marked "R" for right.
- For the Nikon Riflescope 6.5-20x44 A0 adjustment is made by turning the grip by hand. If the bullet hits under the aiming point, turn the grip in the direction of the arrow marked "U" (Fig. 3-11). If the bullet hits to the left of the aiming point, turn the grip in the direction of the arrow marked "R" (Fig. 3-12).

(4) Adjustable objective

The Nikon Riflescope 6.5-20x44 A0, 4-12x40 A0, 3.3-10x44 A0 and 5.5-16.5x44 A0 can be more precisely focused within the range of at least 50 yards (45.72 m) ~ infinity by rotating the objective adjusting ring.

Parallax can be eliminated and sight alignment will be accurate.

Use its distance scale as a reference guide.

Rotation of the adjusting ring is intentionally adjusted to be heavy at the factory so that it will not move easily during shooting.

(5) Changing the grip (6.5-20x44 A0 only)

Remove the protective cap of the grip by turning it counterclockwise. Align the grip to the 0 (zero) position of the scale ring. This is to assure that the scale ring will be correctly aligned to the new grip (the alignment position should be remembered).

With the grip held with your fingers to avoid shifting of the aligned scale ring, turn the bolt in the top of the grip counterclockwise with the hex key supplied until the bolt comes out. Then remove the grip (Fig. 3-13).

Insert the new grip into position and align the scale ring to 0.

Insert the bolt. By securing the grip with our fingers to avoid shifting of the scale ring, turn the bolt clockwise with the hex key supplied, until the grip is firmly secured.

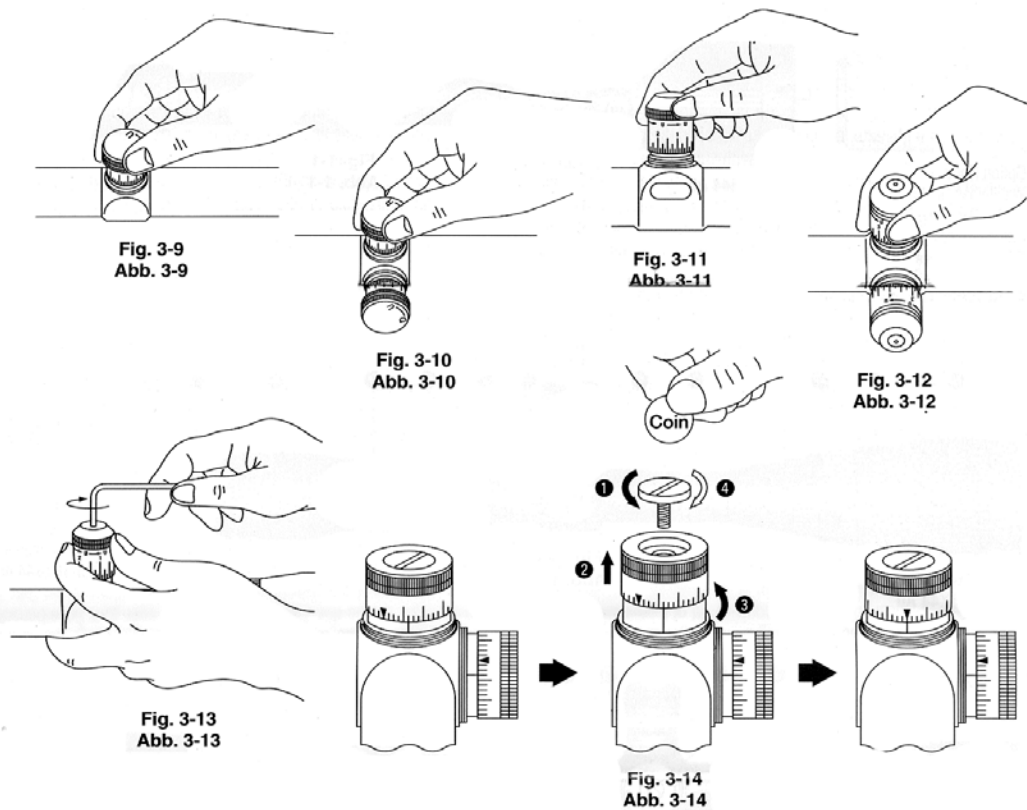

(6) Zero setting of grip (except 6.5-20x44 A0) (Fig. 3-14)

After the reticle has been adjusted to the point of impacts, with the grip held with your fingers to avoid shifting of the aligned grip, turn the grip screw in top of the grip counterclockwise with coin. Then lift the grip up and align the “▼” with the index mark. It may happen that the “▼” could not align with the index mark exactly because of the coupling pitch of the grip with the shaft. And by securing the grip with your fingers to avoid shifting of the grip, turn the grip screw clockwise with the coin until the grip is firmly secured.

Note:

- The windage and elevation scales of the Nikon Riflescope 1.5-4.5x20, 4x40, and 2x20 are calibrated in divisions of $\frac{1}{2}$ minute of angle with a click at intervals of $\frac{1}{4}$ minute of angle (half division).
- The windage and elevation scales of the Nikon Riflescope 3.5-10x50, 3.3-10x44 A0, 4-12x40 A0, 5.5-16.5x44 A0, 3-9x40, 2-7x32, 1.5-4.5x24, 2.5-8x28 and 6x42 are calibrated in division of $\frac{1}{4}$ minute of angle with a click at intervals of $\frac{1}{4}$ minute of angle (one division).
- The windage and elevation scales of the Nikon Riflescope 6.5-20x40 A0 are calibrated in division of $\frac{1}{8}$ minute of angle with a click at intervals of $\frac{1}{8}$ minute of angle (one division).
- When adjusting the reticle to the point of aim, remember that one minute of angle equals approximately one inch (2.54 cm) at 100 yards (91.44 m).

Therefore, if the impact point is two inches (5.08 cm) low and one inch (2.54 cm) right at 100 yards (91.44 m) Parallax Setting, you should adjust two minutes of angle up one minute of angle left. In case of 50 yards (45.72 m). Parallax Setting the adjusting value is double. In case of 75 yards (68.58 m) Parallax Setting is 1.5 times.

Maintenance

(1) Lens cleaning

To remove dirt or fingerprint, soak gauze or lens cleaning paper (silicon-free paper sold at camera shop) with a small quantity of absolute alcohol (available from drugstore) and lightly wipe off. Wiping with leather chamois is not recommended as it is likely to damage the lens surface.

Dust may scratch the lens surface or corrode the lens.

Brush dust off using a soft oil-free brush.

(2) Scope Exterior

Use a soft dry cloth to wipe off any dirt or fingerprints that might accumulate. It is not necessary to oil the scope's surface.

(3) Windage/Elevation Adjustments

These adjustments are permanently lubricated. Do not attempt to lubricate them. Cover with caps supplied, except when adjusting, to keep out dust and dirt.

(4) Eyepiece Adjustment

This adjustment is permanently lubricated. Do not attempt to lubricate.

(5) Power Selector Ring

No lubrication is required on the power selector ring.

Do not loosen or remove screws in power selector ring.

In the event that you should require service for your Nikon RIFLESCOPE, in case of USA market, please send it directly to:

Nikon Scope Service

841 Apollo Street, Suite 100

El Segundo, CA. 90245-4721

1-800-Nikon SV.

In other market, please bring it to dealer from which you purchased it.

Nikon Inc.

1300 Walt Whitman Road

Melville, NY 11747-3064

P: (631)547-8632

F: (631)547-4040

Free Manuals Download Website

<http://myh66.com>

<http://usermanuals.us>

<http://www.somanuals.com>

<http://www.4manuals.cc>

<http://www.manual-lib.com>

<http://www.404manual.com>

<http://www.luxmanual.com>

<http://aubethermostatmanual.com>

Golf course search by state

<http://golfingnear.com>

Email search by domain

<http://emailbydomain.com>

Auto manuals search

<http://auto.somanuals.com>

TV manuals search

<http://tv.somanuals.com>