

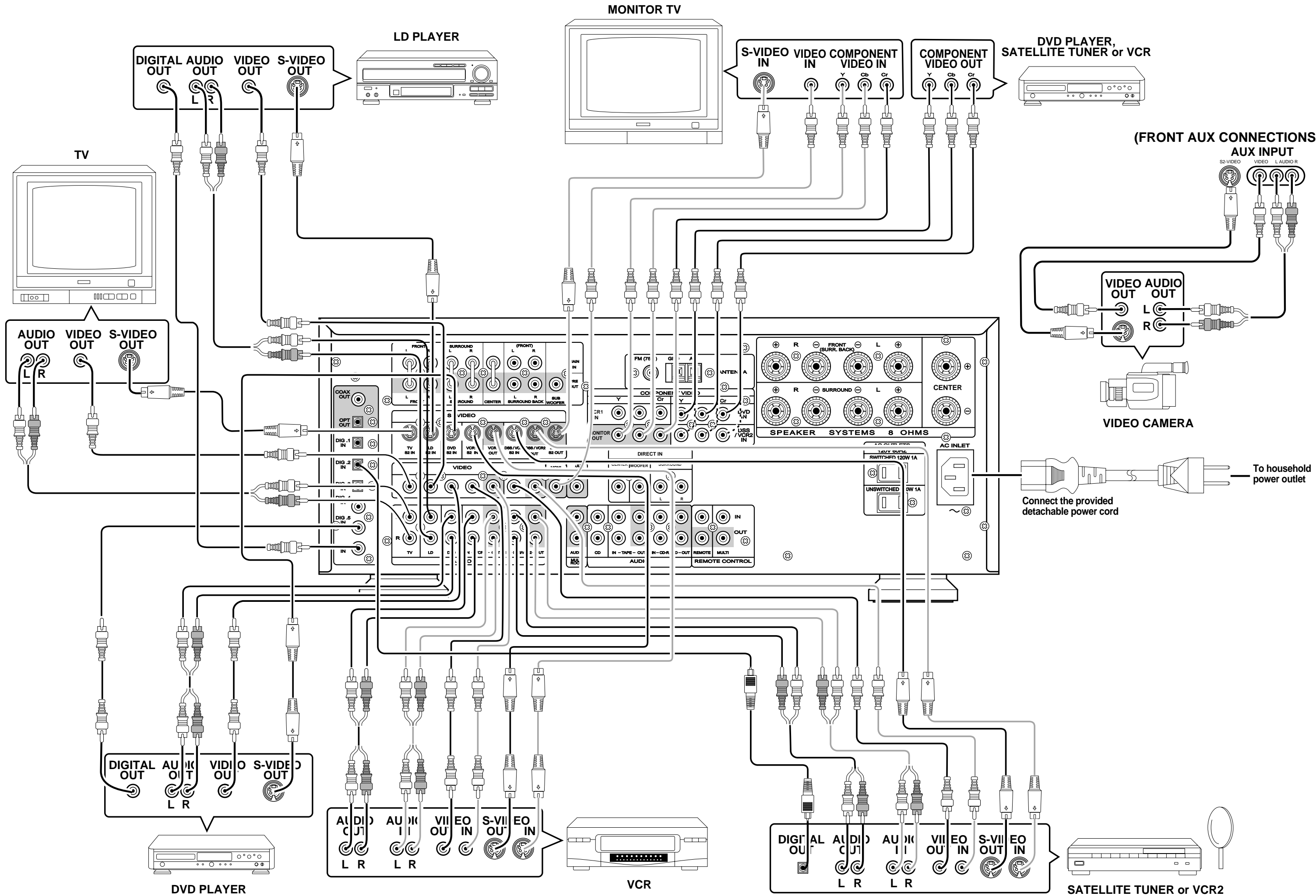
# **marantz®**

## **Model SR-18EX User Guide**

---

AV Surround Receiver

**VIDEO SYSTEM CONNECTIONS FOR VIDEO COMPONENTS**

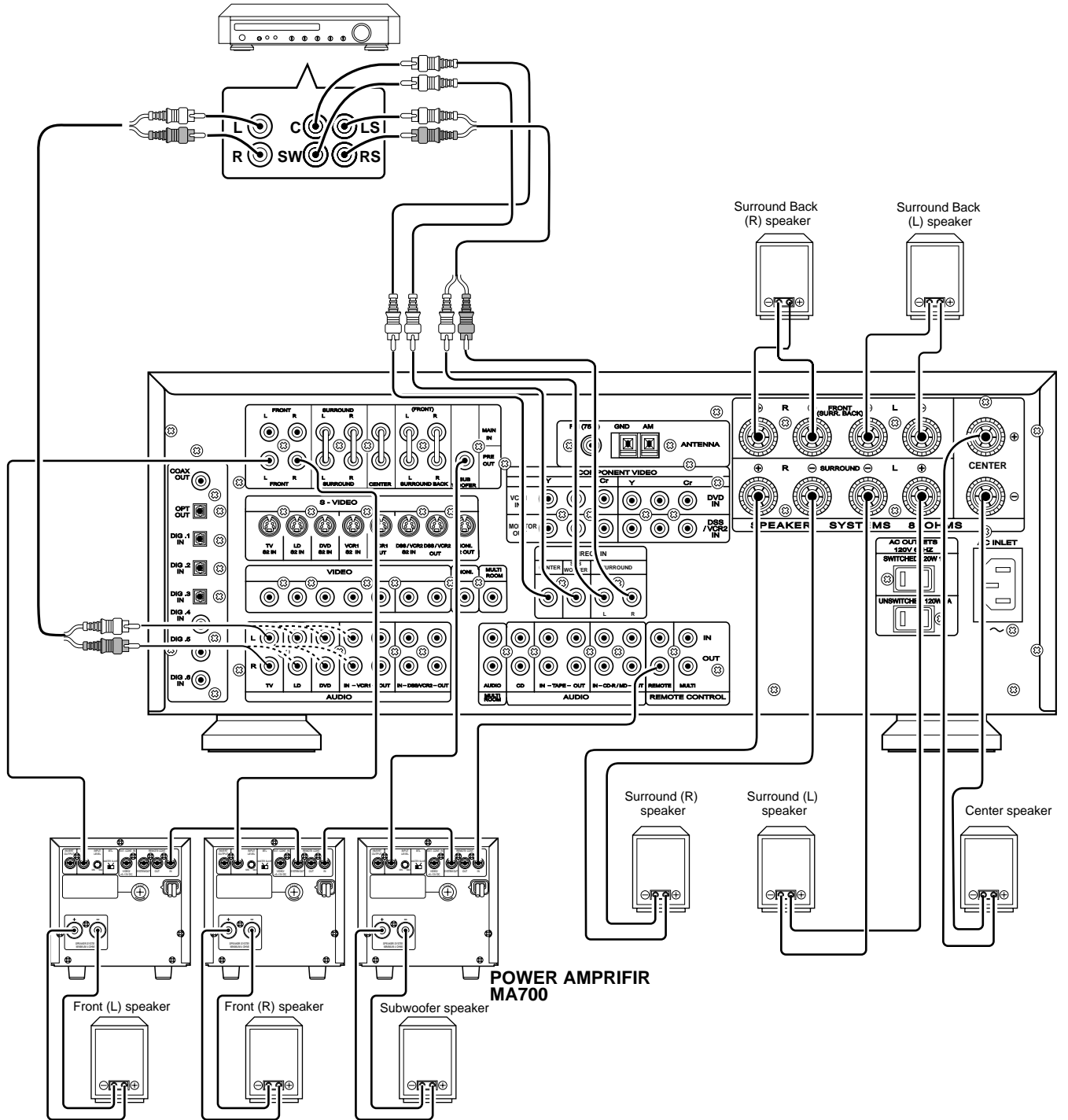


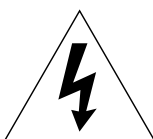
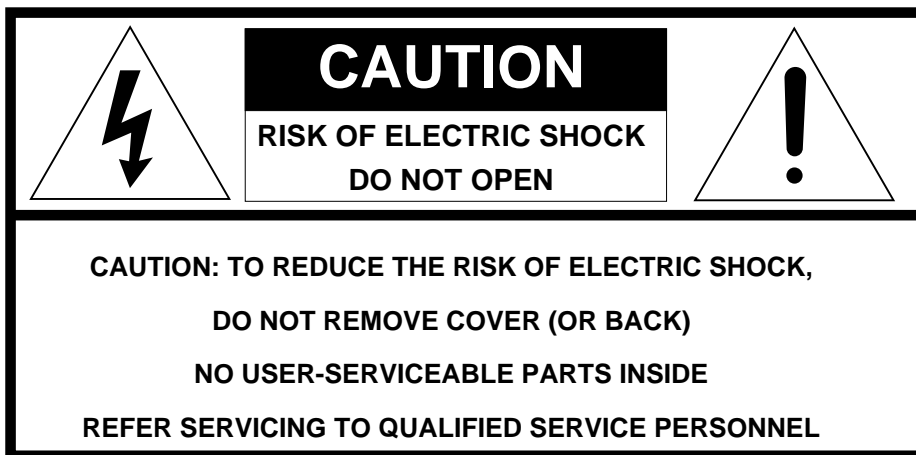


# OTHER CONNECTIONS

(Connectio with external 3ch amplifiers for Front-L, Front-R and subwoofer)

## OTHER MULTI CHANNEL PROCESSOR





The lightning flash with arrowhead symbol, within an equilateral triangle, is intended to alert the user to the presence of uninsulated "dangerous voltage" within the product's enclosure that may be of sufficient magnitude to constitute a risk of electric shock to persons.



The exclamation point within an equilateral triangle is intended to alert the user to the presence of important operating and maintenance (servicing) instructions in the literature accompanying the appliance.

## WARNING

**TO REDUCE THE RISK OF FIRE OR ELECTRIC SHOCK,  
DO NOT EXPOSE THIS APPLIANCE TO RAIN OR MOISTURE.**

**CAUTION: TO PREVENT ELECTRIC SHOCK, MATCH WIDE  
BLADE OF PLUG TO WIDE SLOT, FULLY INSERT.**

**ATTENTION: POUR ÉVITER LES CHOCS ÉLECTRIQUES,  
INTRODUIRE LA LAME LA PLUS LARGE DE LA FICHE DANS LA  
BORNE CORRESPONDANTE DE LA PRISE ET POUSSER  
JUSQU'AU FOND.**

### NOTE TO CATV SYSTEM INSTALLER:

This reminder is provided to call the CATV (Cable-TV) system installer's attention to Article 820-40 of the NEC, that provides guidelines for proper grounding and, in particular, specified that the cable ground shall be connected to the grounding system of the building, as close to the point of cable entry as practical.

### NOTE:

This equipment has been tested and found to comply with the limits for a Class B digital device, pursuant to Part 15 of the FCC Rules. These limits are designed to provide reasonable protection against harmful interference in a residential installation. This equipment generates, uses and can radiate radio frequency energy and, if not installed and used in accordance with the instructions, may cause harmful interference to radio communications. However, there is no guarantee that interference will not occur in a particular installation. If this equipment does cause harmful interference to radio or television reception, which can be determined by tuning the equipment off and on, the user is encouraged to try to

correct the interference by one or more of the following measures:

- Reorient or relocate the receiving antenna.
- Increase the separation between the equipment and receiver.
- Connect the equipment into an outlet on a circuit different from that to which the receiver is connected.
- Consult the dealer or an experienced radio/TV technician for help.

### NOTE:

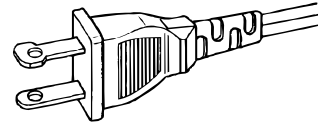
Changes or modifications may cause this unit to fail to comply with Part 15 of the FCC Rules and may void the user's authority to operate the equipment.

# IMPORTANT SAFETY INSTRUCTIONS

## READ BEFORE OPERATING EQUIPMENT

This product was designed and manufactured to meet strict quality and safety standards. There are, however, some installation and operation precautions which you should be particularly aware of.

1. Read Instructions - All the safety and operating instructions should be read before the appliance is operated.
2. Retain Instructions-The safety and operating instructions should be retained for future reference.
3. Heed Warnings-All warnings on the appliance and in the operating instructions should be adhered to.
4. Follow Instructions-All operating and use instructions should be followed.
5. Cleaning-Unplug this video product from the wall outlet before cleaning. Do not use liquid cleaners or aerosol cleaners. Use a damp cloth for cleaning.
6. Attachments-Do not use attachments not recommended by the video product manufacturer as they may cause hazards.
7. Water and Moisture-Do not use this video product near water-for example, near a bath tub, wash bowl, kitchen sink, or laundry tub, in a wet basement, or near a swimming pool, and the like.
8. Accessories-Do not place this video product on an unstable cart, stand, tripod, bracket, or table. The video product may fall, causing serious injury to a child or adult, and serious damage to the appliance. Use only with a cart, stand, tripod, bracket, or table recommended by the manufacturer, or sold with the video product. Any mounting of the appliance should follow the manufacturer's instructions, and should use a mounting accessory recommended by the manufacturer.
9. Ventilation-Slots and openings in the cabinet are provided for ventilation and to ensure reliable operation of the video product and to protect it from overheating, and these openings must not be blocked or covered. The openings should never be blocked by placing the video product on a bed, sofa, rug, or other similar surface. This video product should never be placed near or over a radiator or heat register. This video product should not be placed in a built-in installation such as a bookcase or rack unless proper ventilation is provided or the manufacturer's instructions have been adhered to.
10. Power Sources-This video product should be operated only from the type of power source indicated on the marking label. If you are not sure of the type of power supply to your home, consult your appliance dealer or local power company. For video products intended to operate from battery power, or other sources, refer to the operating instructions.
11. Grounding or Polarization-This video product is equipped with a polarized alternating-current line plug (a plug having one blade wider than the other). This plug will fit into the power outlet only one way. This is a safety feature. If you are unable to insert the plug fully into the outlet, try reversing the plug. If the plug should still fail to fit, contact your electrician to replace your obsolete outlet. Do not defeat the safety purpose of the polarized plug.



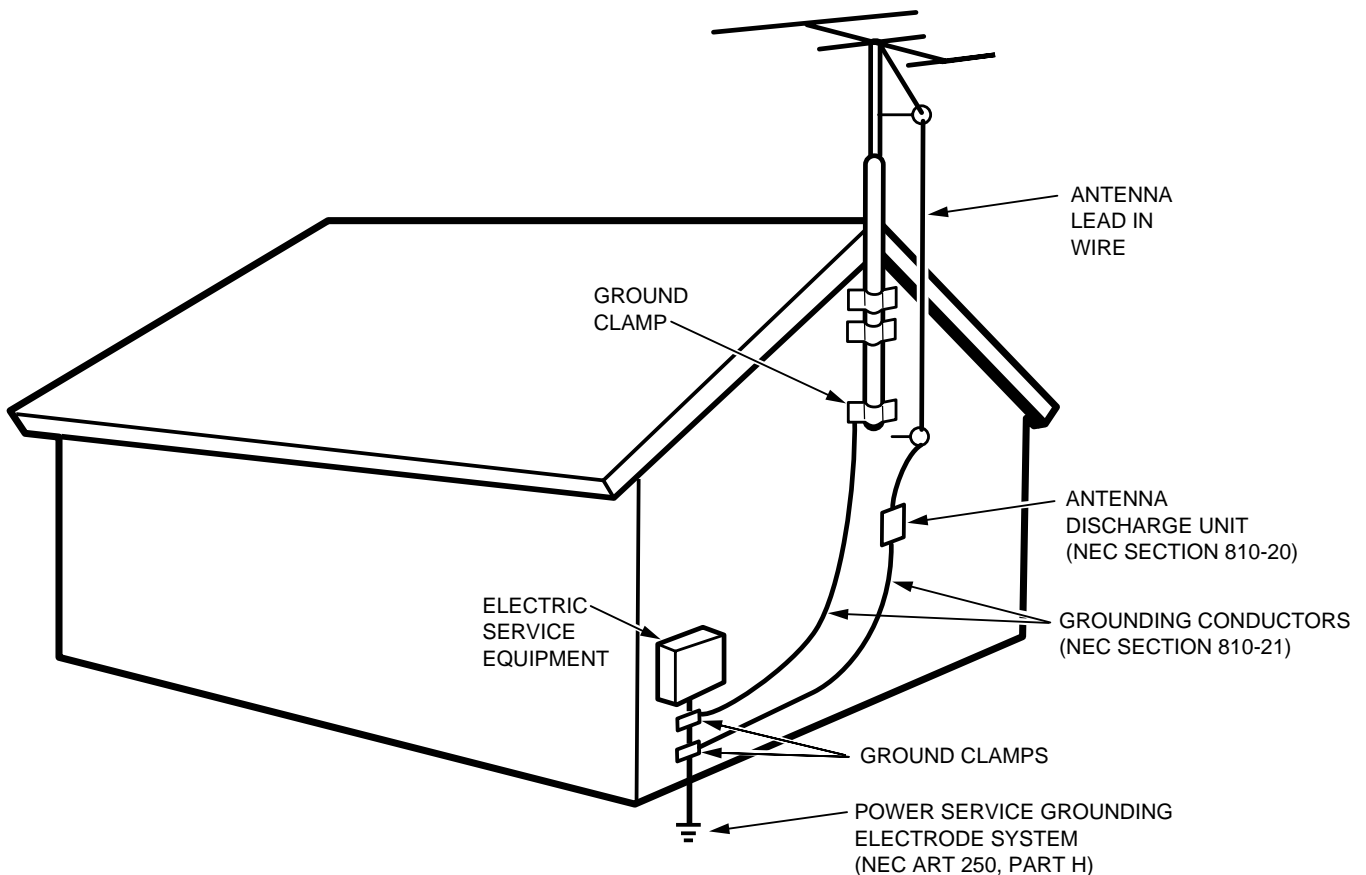
AC POLARIZED PLUG

12. Power-Cord Protection-Power-supply cords should be routed so that they are not likely to be walked on or pinched by items placed upon or against them, paying particular attention to cords at plugs, convenience receptacles, and the point where they exit from the appliance.
13. Protective Attachment Plug - The appliance is equipped with an attachment plug having overload protection. This is a safety feature. See Instruction Manual for replacement or resetting of protective device. If replacement of the plug is required, be sure the service technician has used a replacement plug specified by the manufacturer that has the same overload protection as the original plug.
14. Outdoor Antenna Grounding-If an outside antenna or cable system is connected to the video product, be sure the antenna or cable system is grounded so as to provide some protection against voltage surges and built up static charges. Section 810 of the National Electrical Code, ANSI/NFPA No. 70-1984, provides information with respect to proper grounding of the mast and supporting structure, grounding of the lead-in wire to an antenna discharge unit, size of grounding conductors, location of antenna-discharge unit, connection to grounding electrodes, and requirements for the grounding electrode. See Figure 1.
15. Lightning-For added protection for this video product receiver during a lightning storm, or when it is left un-attended and unused for long periods of time, unplug it from the wall outlet and disconnect the antenna or cable system. This will prevent damage to the video product due to lightning and power-line surges.
16. Power Lines-An outside antenna system should not be located in the vicinity of overhead power lines or other electric light or power circuits, or where it can fall into such power lines or circuits. When installing an outside antenna system, extreme care should be taken to keep from touching such power lines or circuits as contact with them might be fatal.
17. Overloading-Do not overload wall outlets and extension cords as this can result in a risk of fire or electric shock.
18. Object and Liquid Entry-Never push objects of any kind into this video product through openings as they may touch dangerous voltage points or short-out parts that could result in a fire or electric shock. Never spill liquid of any kind on the video product.

19. Servicing-Do not attempt to service this video product yourself as opening or removing covers may expose you to dangerous voltage or other hazards. Refer all servicing to qualified service personnel.
20. Damage Requiring Service-Unplug this video product from the wall outlet and refer servicing to qualified service personnel under the following conditions:
  - a. When the power-supply cord or plug is damaged.
  - b. If liquid has been spilled, or objects have fallen into the video product.
  - c. If the video product has been exposed to rain or water.
  - d. If the video product does not operate normally by following the operating instructions. Adjust only those controls that are covered by the operating instructions as an improper adjustment of other controls may result in damage and will often require extensive work by a qualified technician to restore the video product to its normal operation.
  - e. If the video product has been dropped or the cabinet has been damaged.
  - f. When the video product exhibits a distinct change in performance-this indicates a need for service.
21. Replacement Parts-When replacement parts are required, be sure the service technician has used replacement parts specified by the manufacturer or have the same characteristics as the original part. Unauthorized substitutions may result in fire, electric shock or other hazards.
22. Safety Check-Upon completion of any service or repairs to this video product, ask the service technician to perform safety checks to determine that the video product is in proper operating condition.
23. Carts and Stands-The appliance should be used only with a cart or stand that is recommended by the manufacturer.
24. An appliance and cart combination should be moved with care. Quick stops, excessive force, and uneven surfaces may cause the appliance and cart combination to overturn.



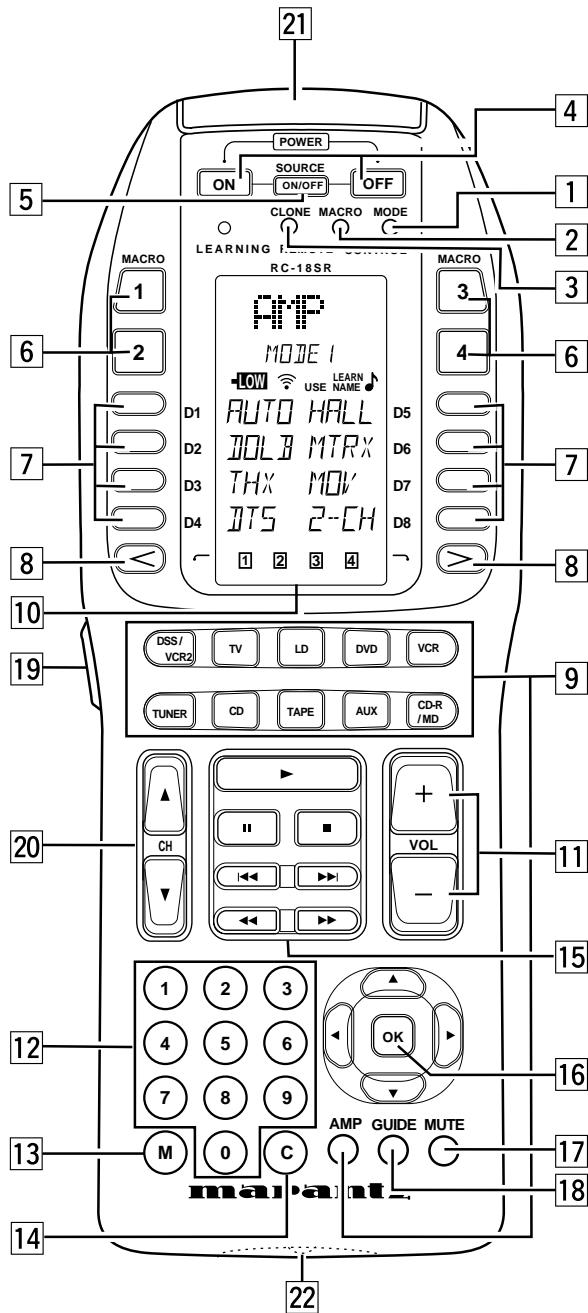
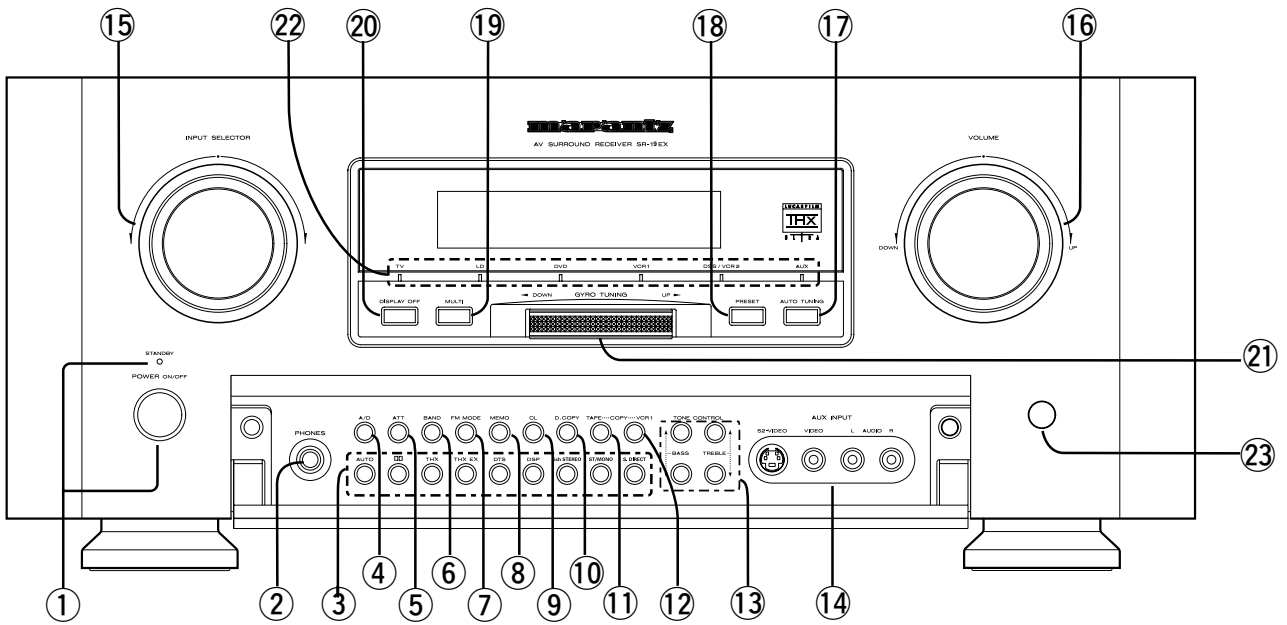
**FIGURE 1  
EXAMPLE OF ANTENNA GROUNDING ACCORDING TO  
NATIONAL ELECTRICAL CODE INSTRUCTIONS  
CONTAINED IN ARTICLE 810 - "RADIO AND TELEVISION EQUIPMENT"**



NEC - NATIONAL ELECTRICAL CODE

This Class B digital apparatus meets all requirements of the Canadian Interference - Causing Equipment Regulations.

Cet appareil numérique de la Classe B respecte toutes les exigences du Règlement sur le matériel brouilleur du Canada.





# TABLE OF CONTENTS

<b>INTRODUCTION</b> .....	<b>5</b>
<b>DESCRIPTION</b> .....	<b>5</b>
<b>FEATURES</b> .....	<b>6</b>
<b>FRONT PANEL FEATURES</b> .....	<b>7</b>
<b>DISPLAY</b> .....	<b>9</b>
<b>REAR PANEL CONNECTIONS</b> .....	<b>10</b>
<b>REMOTE CONTROL UNIT RC-18SR</b> .....	<b>12</b>
OPERATION OF REMOTE CONTROL UNIT .....	13
<b>SETUP</b> .....	<b>14</b>
ON SCREEN DISPLAY MENU SYSTEM .....	14
OSD MENU SYSTEM .....	15
SPEAKERS SETUP AND LEVELS SETUP .....	15
ON SCREEN DISPLAY INFORMATION .....	18
<b>BASIC OPERATION</b> .....	<b>19</b>
LISTENING TO THE TUNER .....	19
PLAYBACK OPERATION .....	20
<b>OTHER FUNCTIONS</b> .....	<b>21</b>
MULTI ROOM SELECTOR .....	21
TV AUTO ON/OFF FUNCTION .....	21
SETTING THE SLEEP TIMER (ONLY REMOTE CONTROL UNIT) .....	21
<b>REMOTE CONTROL UNIT RC-18SR</b> .....	<b>22</b>
OPERATION .....	22
FUNCTION AND OPERATION .....	22
RC-18SR BASIC OPERATION .....	25
ADVANCED PROGRAMMING TECHNIQUES .....	27
OTHER FUNCTIONS .....	31
DIRECT COMMAND FUNCTIONS LISTING .....	32
<b>SURROUND MODES</b> .....	<b>36</b>
<b>TROUBLESHOOTING</b> .....	<b>39</b>
<b>TECHNICAL SPECIFICATIONS</b> .....	<b>41</b>

## INTRODUCTION

Thank you for purchasing the Marantz SR-19EX THX/ DTS/Dolby Digital Surround receiver. This remarkable component has been engineered to provide you with many years of home theater enjoyment. Please take a few minutes to read this manual thoroughly before you connect and operate the SR-19EX. As there are a number of connection and configuration options, you are encouraged to discuss your own particular home theater setup with your Marantz A/V specialist dealer.

## DESCRIPTION



THX® is an exclusive set of standards and technologies established by the world-renowned film production company, Lucasfilm Ltd. THX resulted from George Lucas' desire to reproduce the movie soundtrack as faithfully as possible both in the movie theater and in the home theater.

THX engineers developed patented technologies to accurately translate the sound from a movie theater environment into the home, correcting the tonal and spatial errors that occur.

When the THX mode of the SR-19EX is on, three distinct THX technologies are automatically added:

Re-Equalization-restores the correct tonal balance for watching a movie in a home environment.

These sounds are otherwise mixed to be brighter for a large movie theater. Re-EQ compensates for this and prevents the soundtracks from being overly bright and harsh when played in a home theater.

Timbre Matching-filters the information going to the surround speakers so they more closely match the tonal characteristics of the sound coming from the front speakers.

This ensures seamless panning between the front and surround speakers.

Adaptive Decorrelation-slightly changes one surround channel's time and phase relationship with respect to the other surround channel.

This expands the listening position and creates with only two surround speakers the same spacious surround experience as in a movie theater with multiple surround speakers.

The Marantz SR-19EX was required to pass a rigorous series of quality and performance tests, in addition to incorporating the technologies explained above, in order to be THX Ultra certified by Lucasfilm Ltd.

THX Ultra requirements cover every aspect of performance including pre-amplifier and power amplifier performance and operation, and hundreds of other parameters in both the digital and analog domain. Movies which have been encoded in Dolby Digital, DTS, Dolby Pro Logic, stereo and Mono will all benefit from the THX mode when being viewed.

The THX mode should only be activated when watching movies which were originally produced for a movie theater environment.

THX need not be activated for music, movies made especially for TV, or shows such as sports programming, talk shows, etc.

This is because they were originally mixed for a small room environment.

"Lucasfilm®" and "THX®" are registered trademarks of Lucasfilm Ltd.

## THX SURROUND EX

THX Surround EX - Dolby Digital Surround EX is a joint development of Dolby Laboratories and the THX division of Lucasfilm Ltd.

In a movie theater, film soundtracks that have been encoded with Dolby Digital Surround EX technology are able to reproduce an extra channel which has been added during the mixing of the program.

This channel, called Surround Back, places sounds behind the listener in addition to the currently available front left, front center, front right, surround right, surround left and subwoofer channels.

This additional channel provides the opportunity for more detailed imaging behind the listener and brings more depth, spacious ambience and sound localization than ever before.

Movies that were created using the Dolby Digital Surround EX technology when released into the home consumer market may exhibit a Dolby Digital Surround EX logo on the packaging.

A list of movies created using this technology can be found on the Dolby web site at

<http://www.dolby.com>.

"SURROUND EX™" is a trademark of Dolby Laboratories. Used under authorization.



Dolby Digital lets you enjoy Digital TV, Digital Satellite as well as DVD, LD software in digital surround, which is the next step above Dolby Pro Logic.

In comparison with Dolby Pro Logic, Dolby Digital can provide separate left surround and right surround channels, for more precise localization of sounds and a more convincing, realistic ambience.

And, with Dolby Digital, all five main channels can be full ranged and a subwoofer can be added to each channel, if desired.

By providing up to 5.1 channels of digital audio independently, Dolby Digital lets you enjoy better sound quality and more powerful presence than conventional Dolby Surround.

"Dolby", "AC-3", "Pro Logic" and the double-D symbol are trademarks of Dolby Laboratories.



DTS was introduced in 1994 to provide 5.1 channels of discrete digital audio into home theater systems.

DTS brings you premium quality discrete multi-channel digital sound to both movies and music.

DTS is a multi-channel sound system designed to create full range digital sound reproduction.

The no compromise DTS digital process sets the standard of quality for cinema sound by delivering an exact copy

of the studio master recordings to neighborhood and home theaters. Now, every moviegoer can hear the sound exactly as the moviemaker intended.

DTS can be enjoyed in the home for either movies or music on of DVD's, LD's, and CD's.

"DTS" and "DTS Digital Surround" are trademarks of Digital Theater Systems, Inc.

## FEATURES

- THX SURROUND EX decoding to reproduce an extra channel which has been added during the mixing of the program.
- Dolby Digital and DTS surround sound decoding, plus THX Cinema processing, Dolby Pro Logic decoding and a variety of additional surround modes.
- 96 kHz/ 24 bit decoding for highest possible fidelity and bandwidth, and high-resolution playback of 96 kHz/ 24 bit PCM audio sources.
- Poly Silicon high resolution 8 ch Volume control
- Selectable main input terminals (L/R or Surr.Back L/R)
- 130 watts to each of the five main channels; the power amp section features an advanced, premium high- storage power supply capacitors, and fully discrete output stages housed in cast aluminum heat sinks .
- High Definition Amplifier Module (HDAM) discrete pre-amp output stages.
- 7.1 channel pre-amp outputs for connection to external components such as a subwoofer and external power amplifiers.
- Six-channel direct inputs accommodate future surround sound formats or an external digital decoder.
- Six Digital inputs, for connection to other sources, such as DVD, DSS, CD or LD.
- Two Digital outputs for connection to CD-R or MD.
- High-quality AM/FM tuner with 50 station presets.
- Source Direct switch bypasses, tone controls and bass management for purest audio quality.
- Three sets of Y/Pr/Pb component video inputs and component video outputs provide unsurpassed video quality and switching flexibility from component video sources.
- On- Screen- Display with both Composite and "S" video.
- Front panel A/V inputs, with S-video .
- Easy to use on-screen menu.
- Multi-room capability offers independent control of a second room audio and video system.
- Supplied with RC-18SR programmable learning remote control.

# FRONT PANEL FEATURES (SEE PAGE 3)

## ① POWER switch and STANDBY indicator

You can turn on and off the unit's power using the front panel power switch.

However, if you turn the unit off with the front panel switch, the unit goes completely off rather than to the "standby mode" (Red LED indicator light glows in the standby mode).

The unit cannot be turned on with the remote control when it is not in the standby mode. When the red LED is on, the unit can be turned on via the remote control, or by turning the input selector knob on the front panel.


## ② PHONES jack for stereo headphones

This jack may be used to listen to the SR-19EX's output through a pair of headphones. Be certain that the headphones have a standard 14" stereo phone plug. (Note that the main room speakers will automatically be turned off when the headphone jack is in use.)

### Notes:

- When using headphones, the surround mode will automatically change to **STEREO**.
- The surround mode returns to the previous setting as soon as the plug is removed from the jack.

## ③ Surround MODE buttons

**(AUTO,  (DOLBY), THX, THX-EX, DTS, DSP, 5CH STEREO, STEREO/MONO, S-DIRECT)**

Press the desired button to select surround mode.

### AUTO :

The receiver determines whether the digital input signal is Dolby Digital, PCM-audio or DTS.

### :

This mode is used for source materials encoded in Dolby Digital and Dolby Surround.

### THX (THX Cinema or THX Surround EX) :

THX Cinema mode applies additional processing to Dolby Digital, DTS, and Dolby Pro Logic multi-channel surround sources. Use the THX Cinema mode for all movies on disc, tape or broadcast.

### THX-EX :

THX Surround EX will operate for any 5.1 channel source whenever THX is activated.

### DTS (Cinema or Music) :

This mode is for DTS encoded source materials such as LASER DISC, CD and DVD. Press this button to select DTS-Cinema mode. Press it again to select DTS-Music mode.

### DSP (HALL, MATRIX, MOVIE):

These modes apply additional surround processing to each source for theater, concert hall and stadium like atmospheres. Select desired effect by pressing this button.

### 5CH STEREO:

This mode is used to create wider, deeper and more natural sound effects from two channel source materials.

### STEREO/ MONO :

STEREO mode bypasses all surround processing.

MONO mode is intended for use with old movies, television shows and other programs that have a mono sound tracks.

### S. (Source) DIRECT :

In the source direct mode, the tone control circuit and bass management configuration are bypassed for full range frequency response and the purist audio reproduction.

(See page 23 for more information about surround modes.)

## ④ A/D (Analog/Digital) SELECTOR BUTTON

This is used to select between the analog and digital inputs.

### Note:

- This button is not used for an input source that is not set to a digital input in the system setup 2/2.

## ⑤ ATT (Attenuate) button

If the selected analog audio input signal is greater than the capable level of internal processing, "PEAK" indicator will light up on the display screen. If this happens, you should press the ATT button. "ATT" is displayed when this function is activated.

The signal-input level is reduced by about the half. Attenuation will not work with the output signal of "REC OUT" (TAPE, CD-R/MD, VCR1 and DSS/VCR2 output). This function is memorized for each individual input.

## ⑥ BAND (Tuner Band Selector) button

Press this button to switch the tuner between AM and FM.

## ⑦ FM MODE button

Press this button to select the auto stereo mode or mono mode when the FM band is selected. The AUTO indicator lights up on the display screen in the auto stereo mode.

## ⑧ MEMO (memory) button

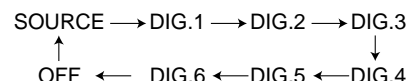
Press this button to enter the tuner preset memory numbers or station names.

## ⑨ CL (Clear) button

Press this button to cancel the station-memory setting mode or preset scan tuning.

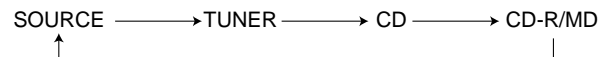
## ⑩ D. ( Digital ) COPY button

Press this button for digital dubbing to a CD-R recorder or MD deck. When this button is pressed, the digital source of the DIGITAL OUTPUT is switched in the following sequence.



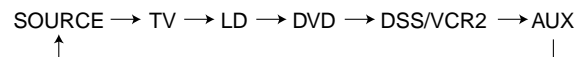
## ⑪ TAPE COPY button

Press this button for audio dubbing to a tape deck. When this button is pressed, the source from the TAPE OUT is switched in the following sequence.



## ⑫ VCR1 COPY button

Press this button for video and audio dubbing to a VCR1 deck. When this button is pressed, the source from the VCR1 OUT is switched in the following sequence.



## ⑬ BASS and TREBLE tone controls

These controls are used to boost or cut high and low frequencies.

**TREBLE:** Adjusts the tone of high-frequency sound.

**BASS:** Adjusts the tone of low-frequency sound.

Press the up and down keys simultaneously to return flat frequency response

### Notes:

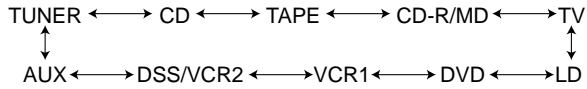
- These buttons are disabled in THX CINEMA mode, THX SURROUND EX mode and Source Direct mode.

**⑭ AUX input jacks**

These auxiliary video/audio input jacks accept the connection of a camcorder, portable VCR, etc.

**⑮ INPUT SELECTOR knob**

When this knob is turned, the input signal is switched in the following sequence.



This knob can also be used to turn the unit's power on when it is in the standby mode.

**⑯ VOLUME control knob**

Adjusts the overall sound level. Turning the control clockwise increases the sound level.

**⑰ AUTO TUNING button**

When this button is pressed and the **GYRO TUNING** knob is flicked quickly, the frequency is scanned while turning the **GYRO TUNING** knob. The Auto scan function starts when the **GYRO TUNING** knob is stopped.

**⑱ PRESET BUTTON**

Press this button to display the preset number. The preset number is changed by rotating the **GYRO TUNING** knob.

**⑲ MULTI (Multi Room) button**

Press this button to activate the Multiroom system. "MULTI" indicator will light up in the display.

**⑳ DISPLAY OFF button**

When this button is pressed, the display is turned off and the display off indicator lights up ( DISP ). Press this button again to turn the display screen ON again.

**㉑ GYRO TUNING knob**

Turn this knob to change the frequency or the preset number. The station name can be selected with this knob.

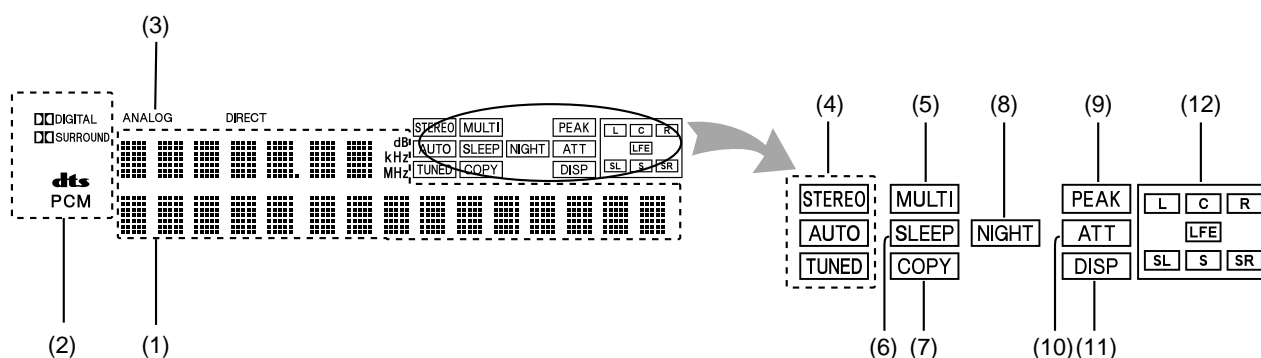
**㉒ VIDEO SOURCE indicator**

Indicates video source currently selected by the input selector.

**㉓ INFRARED SENSOR window**

This window receives infrared signals from the remote control unit.

# DISPLAY



## (1) Main Information Display

This display shows messages relating to the status, input source, surround mode, tuner, volume level or other aspects of the unit's operation.

## (2) ENCODED SIGNAL indicators

**DIGITAL**, **SURROUND**, **dts** and **PCM**

When the selected input is a digital source, one of these indicators will light to display the specific type of signal in use.

## (3) Analog Input Indicator

This indicator lights when an analog input source has been selected.

## (4) TUNER's indicators

**STEREO :**

This indicator illuminates when an FM station is being tuned in stereo.

**AUTO :**

This indicator illuminates when the tuner's Auto mode is in use.

**TUNED :**

This indicator illuminates when a station is being received with sufficient signal strength to provide acceptable listening quality.

## (5) Multiroom Indicator

This indicator lights when the multiroom system is active.

## (6) Sleep Indicator

This indicator lights when the Sleep function is in use.

## (7) Copy Indicators

This indicator lights when VCR1 COPY, TAPE, COPY, or DIGITAL COPY system is active.

## (8) Night Mode Indicator

This indicator lights when the SR-19EX is in the Night mode, which reduces the dynamic range of digital program material at low volume levels.

## (9) PEAK indicator

This indicator is a monitor for an analog audio input signal. If the selected analog audio input signal is greater than the capable level of internal processing, this will light. If this happens, you should press the **ATT** button.

## (10) Attenuation indicator

This indicator lights when the attenuation function is active.

## (11) Display Off indicator

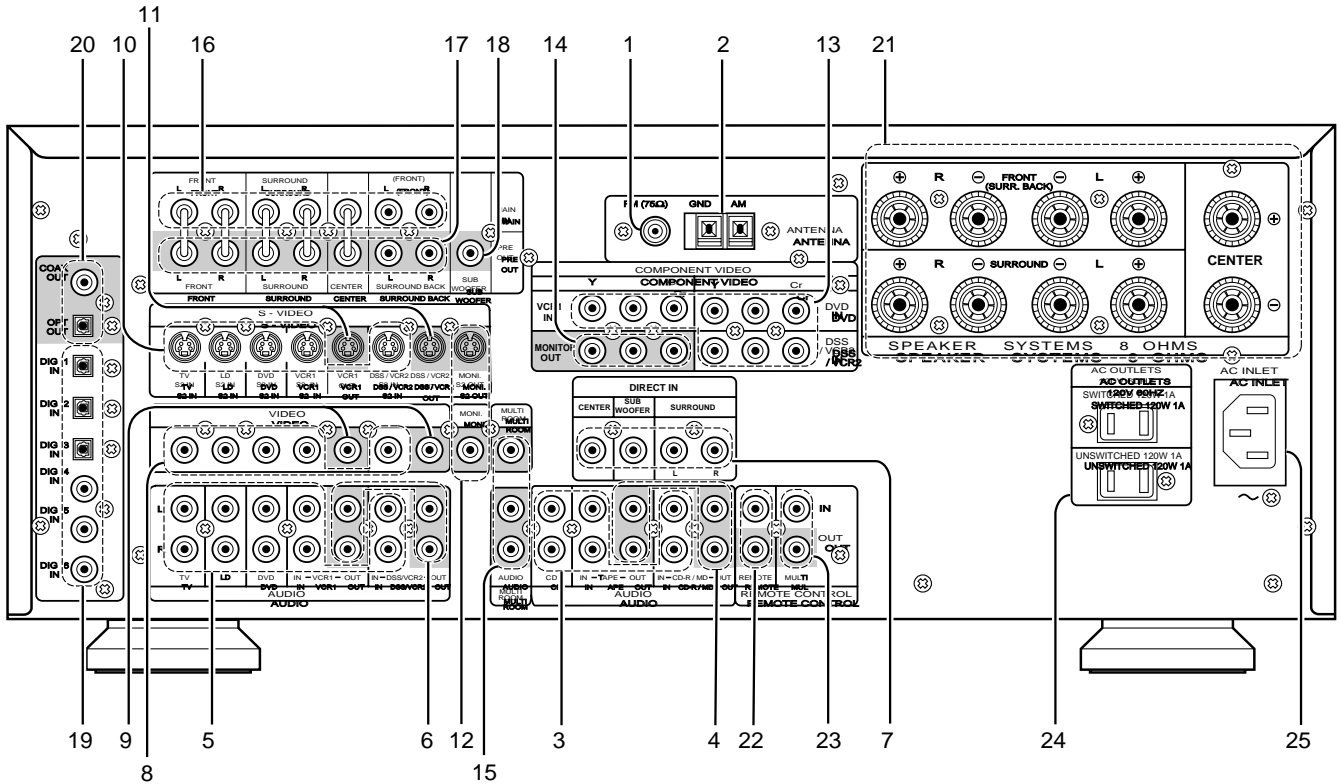
This indicator lights when the SR-19EX is in the display off mode.

## (12) ENCODED CHANNEL STATUS indicators

These indicators display the channels that are encoded with a digital input signal. If the selected digital input signal is Dolby Digital 5.1ch or DTS 5.1ch, "L", "C", "R", "LS", "RS" and "LFE" will light up. If the digital input signal is 2 channel PCM-audio, "L" and "R" will be displayed. If Dolby Digital 5.1ch signal with Surround EX flag comes in, "L", "C", "R", "LS", "S", "RS" and "LFE" will show.

# REAR PANEL CONNECTIONS

All connections to the rear panel should be made with the entire system powered off. To avoid errors, it is advisable to connect one cable at a time between the various components.



## 1 FM antenna terminal (75 ohms)

Connect an external FM antenna with a coaxial cable, or a cable network FM source.

## 2 AM antenna and ground terminals

Connect the supplied AM loop antenna. Use the terminals marked "AM" and "GND". The supplied AM loop antenna will provide good AM reception in most areas. Position the loop antenna until you hear the best.

## 3 Three analog audio inputs

**CD, TAPE, and CD-R/MD :**

Connect the audio outputs of your source components to the input jacks on the receiver.

## 4 Two analog audio outputs for audio source equipment

**TAPE and CD-R/MD :**

Connect each output to the audio inputs (REC in) of your recording equipment.

## 5 Five analog audio inputs for video source equipment

**TV,LD,DVD, VCR1, and DSS/VCR2 :**

Connect each input to the audio outputs of your video source equipment.

## 6 Two analog audio outputs for video source equipment

**VCR1, and DSS/VCR2 :**

Connect each output to the audio inputs (REC in) of your video recording equipment.

## 7 6-Channel Inputs

If an external digital audio decoder is used, connect the outputs of that decoder to these jacks. Note that front L&R channels are common used in analog audio inputs, use the assigned input in OSD setup menu system. (See page 17 "System setup 1/2".)

## 8 Five video inputs

**TV,LD,DVD, VCR1, and DSS/VCR2 :**

Connect each input to the video outputs of your video source equipment.

## 9 Two video outputs

**VCR1, and DSS/VCR2 :**

Connect each output to the video input (REC in) of your video recording equipment.

## 10 Five S-video inputs

**TV,LD,DVD, VCR1, and DSS/VCR2 :**

Connect each input to the S-video outputs of your video source equipment.

## 11 Two S-video outputs

**VCR1, and DSS/VCR2 :**

Connect each output terminals to S-video input (REC in) of your video recording equipment.

## 12 Monitor. (VIDEO/S-VIDEO) output jacks

Connect this jack to the composite or S-Video input of a TV monitor or video projector to view the on-screen menus and the output of any standard video source selected by the receiver's video switcher.

## 13 Three Component-video inputs

### DVD,VCR1,DSS :

Connect the Y/Cr/Cb component video outputs of each your video product to these jacks.

## 14 Component Video Outputs

Connect these outputs to the component video inputs of a video projector or monitor. When a source connected to one of the three **Component Video Inputs** is selected the signal will be sent to these jacks.

## 15 Multiroom Outputs (Audio L&R, Video)

Connect these jacks to the optional audio power amplifiers or video display devices to view and listen to the source selected by the multiroom system in a remote room.

## 16 Main Amplifier Inputs:

When the jumper pins that link the **Preamp Outputs** with these inputs are removed, these jacks may be used to connect an external source to the internal amplifiers.

Front L/R and (Front L/R) are connected internally. If you desire to use internal the 2ch amplifiers of the front L/R channels for the surround back L & R channel, you may remove the jumper pins for front L/R channels, and then connect between (Front L) and preoutput of Surr Back L channel, (Front R) and preoutput of Surr Back R channel.

An external 2channel amplifier may be connected to the preoutput of the Front L&R channels.

(See page iii.)

## 17 Preamp Outputs( L,R,SL,SR,SBL,SBR,C )

When the jumper pins that link the **Amplifier Inputs** with these outputs are removed, these jacks may be connected to an external power amplifier.

## 18 Subwoofer Output

Connect this jack to the line level input of a powered subwoofer. If an external subwoofer amplifier is used, connect this jack to the subwoofer amplifier input. If you are using two subwoofers, either powered or with a 2 channel subwoofer amplifier, connect a "Y" connector to the subwoofer output jack and run one cable from it to each subwoofer amplifier.

## 19 Six Digital Inputs ( Dig. 1 – 6)

### Dig.1,2,3 (Optical), Dig.4,5,6(Coaxial):

Connect the digital output from a DVD player, HDTV receiver, LD player or CD player to these jacks. The signal may be either a Dolby Digital signal, DTS signal or a standard PCM digital source.

## 20 Digital Audio Outputs (Optical, Coaxial)

Connect these jacks to the matching digital input connector on a digital recorder such as a CD-R or Mini Disc recorder.

## 21 Speaker outputs terminals

### Front L, Front R, Surround L, Surround R and Center:

Connect the these jacks to the matching + or – terminals on your speakers. When making speaker connections, always make certain to maintain correct polarity by connecting the red (+) terminals on the SR-19EX to the red terminals on the speaker and the black (–) terminals on the SR-19EX to the black terminals on the speakers. These terminals will accept bare wire or pin connectors. Additionally, your dealer can remove the center plastic "plugs" for you and the terminals will then accept banana plugs as well.

## 22 Remote control In/Out terminals

**INPUT:** This connection permits the IR sensor in the receiver to serve other remote controlled devices. Connect this jack to the "IR IN (RC-5 in)" jack on Marantz or other compatible equipment.

**OUTPUT:** If the SR-19EX's front-panel IR sensor is blocked due to cabinet doors or other obstructions, an external IR sensor may be used. Connect the output of the sensor to this jack.

## 23 MULTI ROOM Remote In/Out terminals

**IN:** Connect to multi-room remote control device, available from your Marantz dealer.

**OUT:** Connect to the Marantz component equipped with remote control (RC-5) terminals in another room. (Second zone).

## 24 AC OUTLETS

Connect the AC power cables of components such as a DVD and CD player to these outlets. Both SWITCHED and UNSWITCHED outlets are provided. The one marked SWITCHED provides power only when the SR-19EX is turned on and is useful for components which you use every time you play your system.

The one marked UNSWITCHED is always live as long as the SR-19EX is plugged into a live outlet.

A component connected here may be left on permanently, or may be switched off with its own power switch.

### Caution:

- In order to avoid potential turn-off thumps, anything plugged in here should be powered up before the SR-19EX is turned on.

## 25 AC INLET

Connect the provided detachable power cord, and connect the AC plug to an unswitched AC wall output.



# REMOTE CONTROL UNIT RC-18SR

This chapter describes the functions which control the SR-19EX. See pages 17-30 to refer to other functions of the RC-18SR.

## 4 POWER ON and OFF

These two buttons are used for turning on or off SR-19EX.

## 7 DIRECT button

The DIRECT command buttons (4 on each side of the LCD display, 8 total) work with the PAGE buttons (4 pages for each source component) to provide up to 32 dedicated specialized functions for each of the 11 function input selectors. Each DIRECT function may also be provided with an alphanumeric function indicator visible in the LCD display. Press the **AMP** or **TUNER** button [9] to control the receiver.

Press one of these buttons to select a surround mode for the current listening session.

AMP		
MODE1	1 <b>AUTO</b>	Auto select surround modes
	2 <b>DOLB</b>	Dolby Digital or Pro Logic decoding
	3 <b>THX</b>	THX cinema or THX Surround EX decoding
	4 <b>DTS</b>	DTS-cinema or DTS-music
	5 <b>HALL</b>	Hall surround sound
	6 <b>MTRX</b>	Matrix surround sound
	7 <b>MOV</b>	Movie surround sound
	8 <b>2-CH</b>	Stereo sound (no surround)
MODE2	1 <b>A/D</b>	analog / digital select switch Switches between the analog input and the digital input.
	2 <b>DIR</b>	source direct switch When this switch is pressed, the signals are transmitted by bypassing the tone control circuitry so that they can be reproduced with higher quality.
	3 <b>ATT</b>	attenuate for analog input
	4 <b>OSD</b>	on screen display Once the button is pressed, the on-screen display is turned on and each a control button related to the SR-19EX is pressed thereafter, the information will be displayed on the TV screen. When the button is pressed again to turn the on-screen display off, it disappears from the TV screen. (Refer to "ON-SCREEN DISPLAY MENU SYSTEM" on page 14)
	5 <b>MONO</b>	monaural decoding When this button is pressed, the monaural sound is selected.
	6 <b>3-D</b>	3-D surround decoding This button is not used for SR-19EX.
	7 <b>NITE</b>	NIGHT mode for Dolby Digital Pressing this button prevents the Dolby Digital signal from playback at a loud voice. This function reduces the voice by 1/3 to 1/4 at maximum. Thus, it eliminates the occurrence of an abruptly loud voice at night. However, the function is valid only for the case when the Dolby Digital signal (AC-3) is entered into digital Input and data to compress the voice exists in the signal to be played back.
	8 <b>MLTI</b>	activates multi-room mode
MODE3	1 <b>TRB+</b>	increases treble
	2 <b>TRB-</b>	decreases treble
	3 <b>BAS+</b>	increases bass
	4 <b>BAS-</b>	decreases bass The button 1 to 4 are used to control the tone.
	5 <b>R-EQ</b>	activates RE-EQ function This button is not used for SR-19EX.
	6 <b>CH+</b>	channel select button Press this button to adjust the volume levels of the front, center, surround, subwoofer channels. Each press of the button changes the channel which can be adjusted.

AMP			
MODE3	7 <b>LVL+</b>	Increases channel level volume	
	8 <b>LVL-</b>	decreases channel level volume After pressing the CH+ button, use the LVL+ and LVL- buttons to adjust the volume level of each speaker channel.	
	Note: These level control is for temporary adjustment, so these setup is not memorized for each source.		
	PROCESSOR	1 <b>VOL+</b>	increases external decoder's volume This button is not used for SR-19EX.
		2 <b>VOL-</b>	decreases external decoder's volume This button is not used for SR-19EX.
		3 <b>6-CH</b>	6 channel direct button When the surround processor is connected to the DIRECT IN JACKS, press this button to play it.
		4 <b>BYP</b>	bypasses external processor's decoding
		5 <b>SLEP</b>	sleep timer button This button is used for setting the sleep timer.
6 <b>DISP</b>		display off function When this button is pressed, the display is turned off.	
7 <b>MODE</b>		surround mode select button	
8 <b>PHNO</b>		phono function button	
TUNER			
BAND	1 <b>FM</b>	FM band button	
	2 <b>AM</b>	AM/MW band button	
	3 <b>LW</b>	long wave band button This button is not used for SR-19EX	
	4 <b>BAND</b>	selects radio band button	
	5 <b>MODE</b>	mono/stereo/muting mode selector button	
	6 <b>TIME</b>	time display button This button is not used for SR-19EX	
	7 <b>F/P</b>	frequency or preset channel display select button This button is not used for SR-19EX	
	8 <b>SCAN</b>	preset scan button	

## 8 PAGE buttons

These buttons are used to select any 1 of the 4 pages of 8 functions for each **DIRECT** button, as explained above.

## 9 FUNCTION buttons

These buttons are used for selecting an input function. Press one of these buttons twice within 2 seconds will activate the chosen input.

## 11 VOLUME UP (+) AND DOWN (-)

These buttons are used to raise and lower the main system volume level.

## 12 TEN KEYPAD

They are useful for tuning a pre-set radio station and setting a station name.

## 13 M (MEMO) button

This button is used to enter the tuner preset memory numbers and station names.

## 14 C (Clear) button

This button is used to cancel certain memory or programming operations.

## 16 CURSOR buttons

The cursor buttons can be used to navigate within on-screen menus. These buttons are unavailable when the mode is set to DSS, TV or DVD.

## 17 MUTE button

This button can be used to mute the sound temporarily.

## 19 LIGHTING button

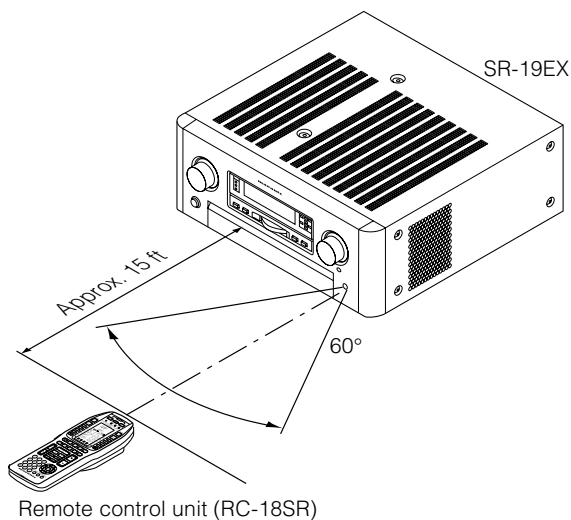
This button is used to activate the back-lit LCD screen and back-lit keys.

## OPERATION OF REMOTE CONTROL UNIT

### 1. Remote control

The distance between the remote control unit and the IR SENSOR of the SR-19EX should be less than about 5 meters. If the transmitter is pointed to a direction other than the IR SENSOR or if there is an obstacle between them, remote control may not be possible.

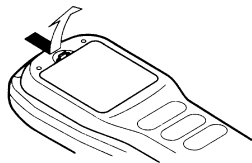
#### Remote-controllable range



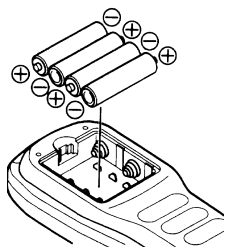
### 2. Loading batteries

The life of the batteries used with the remote control unit is about 4 months with normal use. Also be sure to replace batteries earlier when you notice that they are getting weak.

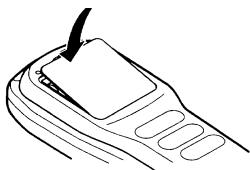
#### (1) Remove the back cover.



#### (2) Insert the alkaline batteries (AA type) with correct (+) and (-) polarity.



#### (3) Close until it clicks.

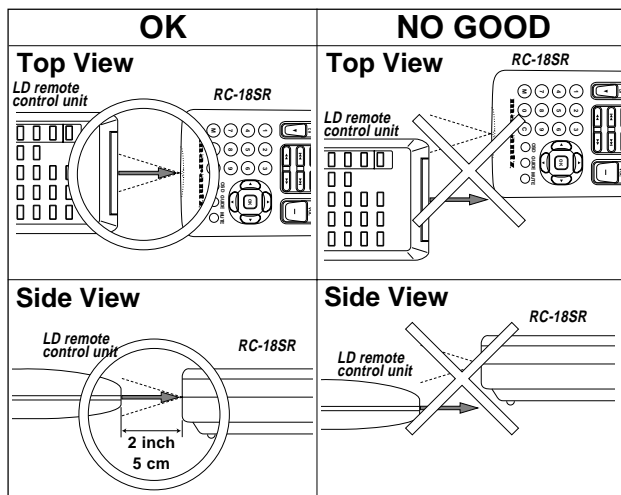


### 3. Receiving the remote control codes

The RC-18SR can learn most of the remote control codes from various equipment, it learns the full word length of the code it is receiving. Due to the sensitivity of the receiving LED the RC-18SR may also "learn" noise from fluorescent lights, etc. which can quickly fill up the memory of the RC-18SR.

In order to maximize the memory capacity of the RC-18SR please pay close attention to the following:

- (1) Aim the transmitting remote control at a direct line of sight to the RC-18SR remote receiver eye.
- (2) Keep 2 inches between transmitting remote and the RC-18SR receiving eye.



# SETUP

After all components are connected, initial setup must be performed.

## ON SCREEN DISPLAY MENU SYSTEM

The SR-19EX incorporates an on-screen menu system, which makes various operations possible by using the cursor (▲, ▼, ►, ◀) and **OK** buttons on the "SETUP" screen in the remote handset.

The settings made with these buttons are also shown in the on-screen display.

### MAIN MENU

```

OSD MAIN MENU

SURROUND MODE
MULTI ROOM SETUP
SYSTEM SETUP
SPKRS SETUP
LEVELS SETUP
BACK GROUND: COLOR-1

EXIT
    
```

### SURROUND MODE

```

SURROUND MODE

SOURCE DIRECT : OFF
SURR-MODE: THX SUR EX
NIGHT MODE : OFF
LFE LEVEL : 0dB

RETURN EXIT
    
```

### SYSTEM SETUP 1/2

```

SYSTEM SETUP 1/2
VCR1 OUT : SOURCE
TAPE OUT : SOURCE
DIG. OUT : SOURCE
TV-AUTO : DISABLE
OSD INFO : ENABLE
S.P.C. : DISABLE
6CH INPUT : OFF

RETURN NEXT EXIT
    
```

### SPKRS SETUP 1/2

```

SPKRS SETUP 1/2
SETUP : UNLOCKED
FRONT L/R : SMALL/THX
SUBWOOFER : YES /THX
SUB-W OUT : THX
CENTER : SMALL/THX
SURR. L/R : SMALL/THX
SURR.BACK : 2CH /THX
SURR.B L/R : SMALL/THX

NEXT
    
```

### MULTI ROOM SETUP

```

MULTI ROOM SETUP
MULTI ROOM : OFF
VIDEO : DVD
AUDIO : DVD
VOLUME LEVEL : VARIABLE
SLEEP TIMER : OFF
---MAIN-ROOM STATUS---
VIDEO: DVD AUDIO: DVD
RETURN EXIT
    
```

### SYSTEM SETUP 2/2

```

SYSTEM SETUP 2/2
CD : DIGITAL 4
TAPE : ANALOG
CD-R : DIGITAL 1
TV : ANALOG
LD : ANALOG
DVD : DIGITAL 5
VCR1 : ANALOG
DSS : DIGITAL 2

RETURN EXIT
    
```

### SPKRS SETUP 2/2

```

SPKRS SETUP 2/2
UNIT : ft
L 10 C 10 SW 10 R 10
SL 10 SBL 10 SB 10 SBR 10 SR 10
RETURN ENTER EXIT
    
```

### LEVEL SETUP 1/2

```

LEVELS SETUP 1/2
TEST MODE : MANUAL
TEST: OFF
L 0 C 0 SW 0 R 0
SL 0 SBL 0 SB 0 SBR 0 SR 0
NEXT
    
```

### LEVEL SETUP 2/2

```

LEVELS SETUP 2/2
BASS PEAK LEVEL

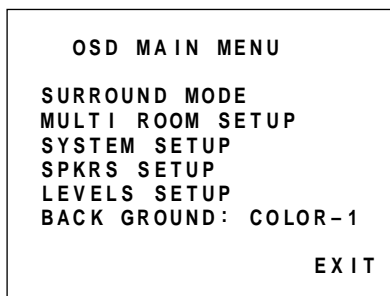
TEST SIGNAL : STOP
VOLUME : +18dB
-----
ENTER

RETURN EXIT
    
```

## OSD MENU SYSTEM

To view the on-screen displays, make certain you have made a connection from the Monitor Out jack on the rear panel to the composite or S-Video input of your TV or projector. In order to view the SR-19EX's displays, the correct video source must be selected on the video display.

### MAIN MENU



1. Press the **AMP** button.
2. Press any one of the cursor buttons (▲, ▼, ►, ◀ and **OK** buttons) to display the "MAIN MENU" of the on-screen display menu. There are six items in the MAIN MENU.
3. Select a desired item with ▲ or ▼ button, and press the **OK** button to select. The display will change to menu for each item.
4. If you desire to change a back ground color of this menu system, move cursor to BACK GROUND and using the ◀ or ► buttons.
5. If you desire to exit from this menu system, move the cursor to EXIT and press the **OK** button.

## SPEAKERS SETUP AND LEVELS SETUP

### SPEAKERS SETUP

#### Speakers size

The first few adjustments tell the SR-19EX which type of speakers are in use. This is important as it adjusts the settings that determine which speakers receive low frequency (bass) information.

If you use full THX speaker systems which are approved by LUCASFILM LTD, set to the **SMALL/THX** position for front L/R ch., center ch., surr. L/R ch., surr.back ch, and then select subwoofer =YES.

In turn, these settings will determine which speakers receive low frequency (bass) information.

For the purpose of establishing proper bass reproduction, use the **LARGE** settings if the speaker being used at any position is a traditional full-range loudspeaker that is capable of reproducing sound below 80 Hz.

Use the **SMALL** setting for smaller, frequency-limited satellite speakers that are not able to reproduce sounds below 80Hz. Note that when "small" speakers are used, a subwoofer is required to reproduce low frequency sounds.

Low frequency sounds from every channel in your system can be fed to a single subwoofer, since low frequency sounds are non-directional and not location sensitive. The SR-19EX will automatically send low frequency signals from any channel set to "SMALL" to the Low Frequency Effects (Subwoofer) channel.

Remember that the "large" and "small" descriptions do not refer to the actual physical size of the speakers, but to their ability to reproduce low frequency sounds.

If you are in doubt as to which category describes your speakers, consult the specifications in the speakers' owner's manual, or ask your dealer.

### SPEAKER TYPE AND POSITIONING FOR THX SURROUND EX

#### Type

THX suggests the use of pair of dipolar speakers for the Sb channels but a pair of monopole type speaker may also be used.

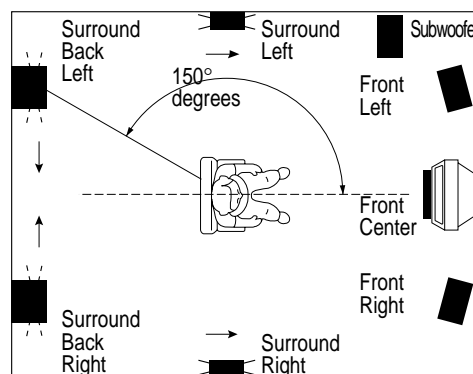
#### Positioning

It has been found that an angle of 150° from the Front Center speaker is a good starting point for establishing the location of Sbl and Sbr speakers. This is suggested from AES preprint #4860. The optimum position for Surround Back speakers is somewhat room dependent. The Surround Back channel should be enveloping but not lost in the sound of the side speakers. Most dipoles have an arrow on them to indicate their orientation towards the screen. So for the side dipole, the arrows point forward. For the back dipoles, the arrows should point towards each other to achieve the correct acoustical phasing in the room:

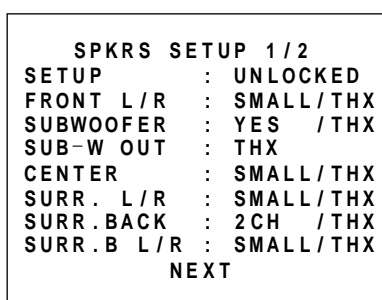
Diagonal lines from speaker indicate dipole.



Dashed diagonal lines indicate dipole or monopole.



### SPKRS SETUP 1/2 (SPEAKER SIZE)



**SETUP:** Select "LOCK" with ◀ or ► button in order to lock the contents of the SPKRS SET UP & LEVELS SETUP MENU. Then, when the contents of the these setup menus needs to be changed, select "UNLOCK" with ◀ or ► button.

**FRONT L/R:** Select the size of front L/R speakers, "SMALL/THX" or "LARGE" with ◀ or ► button.

**SUBWOOFER:** Select "YES" if a subwoofer is connected to your system, select "NO" subwoofer is NOT connected to your system.

**SUB-W OUT:** "THX" position is required, but If you desire an additional front L/R mixed subwoofer output in the STEREO mode, select "L/R MIX" with ◀ or ► button. This setup is available when FRONT L/R is set "LARGE". Notes that SURR BACK will be set "NONE".

**CENTER:** Select the size of center speaker "SMALL/THX", "LARGE", with ◀ or ► button. Select "NONE", if a center speaker is NOT connected to your system.

**SURR. L/R:** Select the size of surround L/R speakers "SMALL/THX", "LARGE", with ◀ or ► button. Select "NONE", if surround speakers are NOT connected to your system.

**SURR. BACK:** Select the number of surround back channels, "2ch/THX", "1ch" or "NONE", with ◀ or ► button. The THX Surround EX system requires two speakers for surround back channels.

But if you have only one speaker for the surround back channel, select "1CH".  
(Note: If 1CH is selected, the signal of surround back will go out from pre output of surround back L ch only. In that case, connect your external amplifier to this output terminal.)

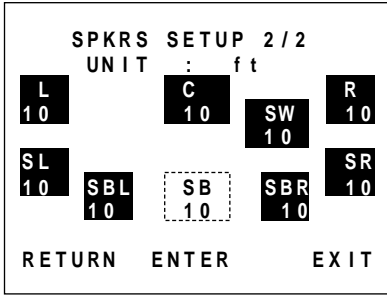
Select "NONE", if a surround back speaker is NOT connected to your system.

(Note: If the surround back speaker is selected "NONE", THX Surround EX mode is not available.)

**SURR. B L/R:** Select the size of the surround back speaker(s) "SMALL/THX", "LARGE", with ◀ or ► button. If a surround back speaker(s) is connected to your system.

**NEXT:** Move cursor to here, and press "OK" button to go to **SPEAKERS SETUP 2/2**.

**SPKRS SETUP 2/2 (SPEAKER DISTANCE)**



**Speaker distance for time alignment**

Use this parameter to specify the distance of each speaker's position from the listening position. The delay time is automatically calculated according to these distances.

**UNITS:** The units may be selected in "ft" or "m" with ◀ or ▶ button. If you select "ft" the setting parameter will change in 1 foot increments. If you select "m" it will change in 0.3 meters increments.

Begin by determining the ideal or most commonly used seating position in the room.

(There are several useful books and special DVD and LD's available to guide you through proper home theater configuration. If you are unsure, have your Marantz dealer perform the installation for you. They are trained professionals familiar with even the most sophisticated custom installations. Marantz recommends the WWW.CEDIA.ORG website for further information about this).

Then provide the distance values from that point to each speaker during the speaker setup process.

Select the target speaker with "OK" button, and input parameter with ◀ or ▶ button.

After input for each speaker's distance has been finished, move cursor to ENTER with ▲ or ▼ button and press the OK button.

If your input is out of the range of the SR-19EX's processing, "incomplete channel" will flash.

In that case, input an acceptable parameter or improve the speaker placement.

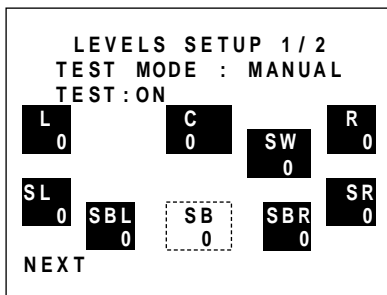
The maximum distance a speaker may be placed is 30 feet (9 meters) from the listening position, which means you can setup your system in a room which is 60 feet long! If your home theater room is larger than this please consult a professional as it is sized more closely to a real movie theater!

The time alignment feature does not function in the STEREO, SOURCE-DIRECT, 5ch Stereo and 6 CHANNEL INPUT modes.

**RETURN :** If you desire to return the main menu, press the "OK" button on RETURN.

**EXIT :** If you desire to exit from OSD menu system, press the "OK" button on EXIT.

**LEVELS SETUP 1/2 (TEST TONE GENERATOR)**



**TEST MODE :** Selects the mode for generating the test tone. If you select **AUTO** with ◀ or ▶ button, the test tone will be cycled through in a circular pattern which is Left → Center → Right → Surround Right → Surround Back Right → Surround Back Left → Surround Left → Subwoofer → Left → ...in increments of 3 seconds for each channel.

If you select **MANUAL**, press the **OK** button to cycle through the test tone channels after the "TEST TONE ON".

**TEST TONE:** Press the **OK** button, ON is indicated and the test tone starts from the front left speaker.

**Notes :** Master volume level will be automatically set at the 0 dB position.

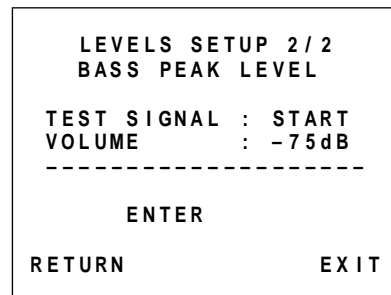
**Level adjust :** Adjust the level of the test tone for each channel with the **LVL+**, **LVL-** or ◀, ▶ buttons of the RC-18SR. The current volume level is shown at the center of the display.

**Notes:**

- The setup level for each channel is memorized for reproduction in all surround mode.
- These levels are common for all surround modes, except 6CH-INPUT mode.
- In order to correctly set the output levels, use a hand-held Sound Pressure Level meter (SPL), set to C-Weighting and Slow averaging.
- A Radio Shack® SPL meter (catalogue number 330 - 2055) works well.
- Using the internal channel noise generators, set each channel so that you read 75 dB SPL from each channel when seated at the listening position.

**LEVELS SETUP 2/2 (BASS PEAK LEVEL LIMIT)**

With Dolby Digital and DTS, not only the LFE (Low Frequency Effects), but also the bass of all channels can be heard from the Subwoofer or Large-speakers. This procedure prevents these speakers from becoming too loud and creating an unbalanced sound. Since the sound is output at a loud volume, perform this operation carefully.



**TEST SIGNAL:** Press the **OK** button, START is indicated and it begins to generate a Bass test tone from the speaker which was designated "bass signal output" during setup.

There will be no audible sound yet because the Master volume is set to minimum automatically.

Press ▼ button to move the cursor to VOLUME control.

**VOLUME:** Adjust the bass test tone output level up until the bass begins to distort or you reach the maximum level with the **VOL+**, **VOL-** or ◀/▶ button. Press ▼ button to move the cursor to ENTER.

**ENTER:** Press the **OK** button, ENTER will blink and stop generating the Bass - test tone.

The Bass Peak Limit Level for your system has now been memorized.

**Notes:**

- Each time the subwoofer level is changed, perform the Bass Peak Level setup and correct the setting.
- The bass peak limiter is not effective in STEREO, SOURCE-DIRECT 5ch STEREO, and 6CHANNEL-INPUT mode.
- The selected value is displayed in the volume column before the test signal starts.

## SYSTEM SETUP 1/2

```

SYSTEM SETUP 1 / 2
VCR1 OUT : SOURCE
TAPE OUT  : SOURCE
DIG. OUT  : SOURCE
TV-AUTO   : DISABLE
OSD INFO  : ENABLE
S.P.C.    : DISABLE
6CH INPUT : OFF

RETURN    NEXT      EXIT
    
```

**VCR1 OUT :** Select the video source from the VCR1 output with ◀ or ▶ button for video and audio dubbing to the VCR1 deck.

The source is switched in the following sequence.  
SOURCE → TV → LD → DVD → DSS/VCR2 → AUX → SOURCE → ....

To determine each source, display the desired source and press the ▲ or ▼ button.

**TAPE OUT :** Select the audio source from the TAPE output with ◀ or ▶ button for audio dubbing to the tape deck. The source is switched in the following sequence.

SOURCE → TUNER → CD → CD-R/MD → SOURCE → ....

To determine each source, display the desired source and press the ◀ or ▶ button.

**DIG. OUT :** Select the digital source from the DIGITAL output with ◀ or ▶ button for digital dubbing to a CD-R recorder or MD deck.

The source is switched in the following sequence.  
SOURCE → DIG.1 → DIG.2 → DIG.3 → DIG.4 → OFF → SOURCE →

To determine each source, display the desired source and press the ▲ or ▼ button.

**TV AUTO:** This product is equipped with a TV-auto ON/OFF system, which automatically turns on or off the SR-19EX power 1 second (for ON) and up to 5 minutes (for OFF) after the TV video input signal is present or absent.

Switch the TV AUTO ON/OFF function to enable or disable with or button. To use this function, connect the TV video input to TV tuner's video output.

**OSD Info :** If you select enable, SR-19EX will display the status of the feature (Volume up/down, input select, etc..) on the TV monitor.

But if you do not desire this information , select "DISABLE ".

**S.P.C. :** System Power Control : If you select "ENABLE", the SR-19EX will output a power On/Off command for a CD player, MD player, or DVD player, from the remote output terminal.

If you have corresponding marantz products , you can turn them on/off simultaneously with SR-19EX.

**6CH. INPUT:** 6 channel direct inputs on the SR-19EX share the front channel of the desired source. Select the desired source with ◀ or ▶ button.

## SYSTEM SETUP 2/2 (ASSIGNABLE DIGITAL INPUT)

Six digital inputs can be assigned as the desired source.

Use this menu to set the SR-19EX for connected equipment and type of connection.

```

SYSTEM SETUP 2 / 2
CD      : ANALOG
TAPE    : ANALOG
CD-R    : ANALOG
TV      : ANALOG
LD      : DIGITAL 1
DVD     : DIGITAL 4
VCR1    : ANALOG
DSS     : ANALOG

RETURN          EXIT
    
```

### Example:

When the digital output of a DVD player is connected to Digital 4 (input jack) of the SR-19EX and an optical digital output from a LD player are connected to Dig.1.

1. Move the cursor on the DVD with ▲ or ▼ button, and select DIGITAL4 with ◀, ▶ button.
2. Move the cursor on the "LD" with ▲ or ▼ button, and select DIGITAL1 with ◀, ▶ button.  
(Move the cursor with ▲ or ▼ button, input is determine.)

### Notes

- The TUNER and AUX are fixed to the analog input, and cannot be selected for any digital input.
- When a DTS-LD or DTS-CD is playing, this setup is not available. This is to avoid noise being generated from the analog input. In this case, the DTS audio must be played through the player's digital output to the digital input on the SR-19EX. This is because the DTS soundtracks replace the standard PCM soundtracks on DTS discs.
- The SR-19EX does not switch from digital input to analog input or vice versa automatically. In case both digital and analog inputs are connected to the SR-19EX, if you desire to switch to analog input temporarily, you can do so by pressing the **A/D** button.

## SURROUND MODE

```

SURROUND MODE

SOURCE DIRECT : OFF
SURR-MODE : DTS-CINEMA
NIGHT MODE : ON
LFE LEVEL : -10 dB

RETURN          EXIT

```

**SOURCE DIRECT :** Switch the source direct ON or OFF with ◀ or ▶ button.

In this mode, SR-19EX bypasses the digital processing and crossover for the main speakers (front left and right will be full range and the subwoofer will be ON)

**Note:** Source Direct mode will be off if Surround mode is changed.

**SURR-MODE :** Select the surround mode with < or > button. Surround mode will change by scrolling as follow. AUTO → THX5.1(THX4.0) → THX Sur EX → DOLBY D(DOLBY PL) → DTS-CINEMA → DTS-MUSIC → HALL → MATRIX → MOVIE → 5CH STEREO → STEREO → MONO →

**NIGHT MODE :** Switch the NIGHT MODE ON or OFF with ◀ or ▶ button.

Selecting the Night Mode ON is effective in Dolby Digital only, and it compresses the dynamic range.

This softens loud passages such as sudden explosions, to help prevent disturbing others late at night.

**LFE LEVEL :** Select the output level of the LFE signal included in the Dolby Digital signal or the DTS signal. Select 0dB, -10 dB or OFF with ◀ or ▶ button. The level is ordinarily set to 0 dB except DTS-Music mode. In the DTS-Music mode, default level is set to -10 dB.

## MULTI ROOM SETUP

```

MULTI ROOM SETUP

MULTI ROOM : ON
VIDEO      : VCR1
AUDIO      : FM 102.00
VOLUME LEVEL : VARIABLE
           : -75 dB
SLEEP TIMER : 90 min
---MAIN-ROOM STATUS---
VIDEO:VCR1 AUDIO:VCR1
RETURN          EXIT

```

**MULTI ROOM :** To switch on the Multi-room output.

**VIDEO :** Select the video source of the Multi-room output with ◀ or ▶ button.

**AUDIO :** Select the audio source of the Multi-room output with ◀ or ▶ button.

**VOLUME LEVEL :** Select whether the Multi-room output level is variable or fixed with ◀ or ▶ button and move cursor to position for level with v button and adjust the Multi-room output level with ◀ or ▶ button.

**SLEEP TIMER :** SLEEP timer function for multi room is available, set the time with ◀ or ▶ button.

**MAIN ROOM STATUS :** Selected input source in the main room will be displayed.

**Notes:**

- If "VOLUME" is set to "FIXED", the multi-room output level cannot be adjusted from the second zone.
- You cannot transmit a digital signal using the multi-room function.
- Any source component that is desired to be operated in the second zone needs to have its analog inputs connected to the receiver.

## ON SCREEN DISPLAY INFORMATION

The on-screen display, which can be activated by the Main unit or remote, appears on the TV screen to show the current setting status of the SR-19EX.

These are available, when OSD INFO setup is selected "ENABLE".

**1. GENERAL INFORMATION**

When the **OSD** button is pressed, the current settings are displayed on the TV monitor.

Press the OSD button again, and this display will disappear.

This information will disappear automatically in about 10 seconds after the button is pressed.

```

VIDEO      : VCR1
AUDIO      : FM 102.00
DIGITAL IN : DIG-1
DIGITAL OUT: DIG-6

SURR-MODE : DTS-CINEMA
MULTIROOM : ON

MASTER VOLUME
-----

```

**VIDEO SOURCE:** Displays the current video source being selected with the function selector **TV, LD, DVD, VCR1, DSS** or **AUX**.

**AUDIO SOURCE:** Displays the current audio source being selected with the function selector **FM, AM, CD, TAPE, CD-R, TV, LD, DVD, VCR1, DSS, AUX** or **6ch**.

**DIGITAL INPUT:** Displays the selected digital input. **DIG-1, DIG-2, DIG-3, DIG-4, DIG-5, or DIG-6**.

**DIGITAL OUTPUT:** Displays the digital output that is being used for recording **SOURCE, DIG-1, DIG-2, DIG-3, DIG-4, DIG-5, DIG-6** or **OFF**.

**SURROUND MODE:** Displays the current surround mode **AUTO, DOLBY, THX 5.1, THX -EX, DTS-CINEMA, DTS-MUSIC, HALL, MATRIX, MOVIE, 5-STEREO, STEREO, MONO** or **S-DIRECT**.

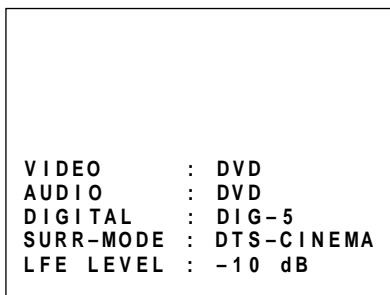
**MULTI ROOM:** Displays the current status of the Multi Room function.

**MASTER VOLUME:** Displays the current volume level. The volume level moves higher to right of the display, and the pointer changes to " " at 0 dB.

**Note:**

- The On-Screen Display signals for the main room can be output from the TV MONI composite video (RCA) output and the TV MONI, S-Video output jacks.
- With some video equipment or software, the On-Screen Display characters may be distorted due to noise or tracking adjustment error.

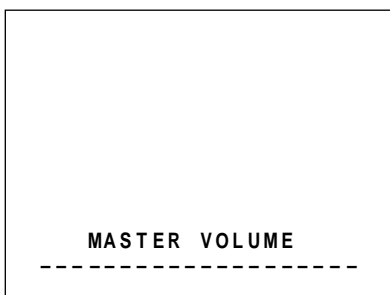
## 2. FUNCTION SELECT & SURROUND MODE



When a function or surround mode button is selected:

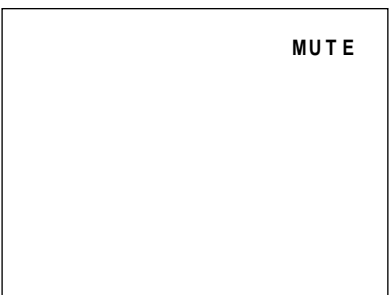
- VIDEO:** Displays the current video source. When DSS/TV, LD, DVD, VCR or AUX is selected with the function selector, both AUDIO and VIDEO shows the same name.
- AUDIO:** Displays the current analog audio input source.
- DIGITAL:** Displays the current digital input source.
- SURR-MODE:** Displays the current Surround mode as follows;  
**AUTO, DOLBY, THX 5.1, THX Sur. EX, DTS CINEMA, DTS MUSIC, HALL, MATRIX, MOVIE, 5-STEREO, STEREO, MONO, S-DIRECT, or 6CH-INPUT.**

## 3. MASTER VOLUME CONTROL



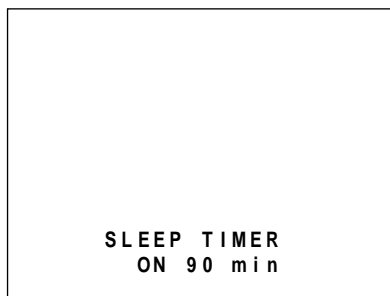
Displayed when the MASTER volume is varied or a button of the remote handset is pressed. The box display indicates the 0 dB level with a solid box "□".

## 4. MUTE



When the MUTE button is pressed on the remote control, "MUTE" will be shown on screen. Pressing MUTE button again will clear the display, or adjust the volume.

## 5. SLEEP TIMER



When the SLEP button (D5) is pressed, the setting on or off and the remaining time of the sleep timer function are displayed. You can change the mode between on, off and the amount of time to elapse before the unit will shut itself off by cycling the SLEP button.

# BASIC OPERATION

## LISTENING TO THE TUNER

Frequency scan step for AM is selectable. Default is 10 kHz step. If your country's standard is 9 kHz step, prress "AM" button on the remote more than 6 seconds. Scan step will change.

**Note:**

- Memory for the tuner will clear by this setup.

## MANUAL TUNING

1. To select the tuner as the source, turn the **INPUT SELECTOR** knob (15) on the front panel or press the **TUNER** button (9) on the remote.
2. Press the **BAND** button (6) on the SR-19EX or **FM (D1)/ AM (D2)** button on page 1 at TUNER MODE on the remote to select the desired frequency band if required.
3. Press the **AUTO TUNING** button (17) on the SR-19EX to display the frequency.
4. Turn the **GYRO TUNING** knob (21) on SR-19EX or press ◀ or ▶ button on the remote.
5. If FM is selected, press the **FM MODE** button (7) on the front panel or the **MODE** button D5 on the remote to select the desired audio mode.

## AUTO TUNING (USING THE SR-19EX)

Light up the "AUTO TUNING" indicator by pressing the **AUTO TUNING** button (17) and turn the **GYRO TUNING** knob (21).

## AUTO TUNING (USING THE REMOTE CONTROL UNIT)

The ◀ or ▶ button is pressed for more than 1 second to start Auto tuning function.

## (FM) MODE Button Operation

When "AUTO" indicator is on in the display, FM stations which broadcast in stereo will be received in stereo and the "STEREO" indicator lights.

When "AUTO" indicator is off, all the FM stations will be received in monaural regardless of whether or not they are broadcasting in stereo.

## PRESET TUNING

With this unit you can preset up to 50 FM/AM stations in any order. For each station, you can memorize the frequency and reception mode if desired.

### 1-a. Manual Presetting (Using the SR-19EX)

1. Refer to the "MANUAL TUNING" or "AUTO TUNING" section above to tune in a desired station.
2. Press the **MEMO** button (8). "PRESET - -" indicator starts blinking on the display. While this is still blinking (approx. 5 seconds), select the preset number by turning the **GYRO TUNING** knob (21), then press the **MEMO** button again.
3. When a number has been properly input, The display stops blinking. The station is now stored in the specified preset memory location.

### 1-b. Manual Presetting (Using the remote unit)

1. Tune in a desired station.
2. Press the **M** button (13) of Tuner mode.
3. Enter the desired preset number with ten keypad (12).  
 \* When entering a single digit number (2, for example), either input "02" or just input "2" and wait for a few seconds.  
 \* If a number other than 1-50 is entered by mistake, that number flashes in the display to indicate that it is invalid and the display returns to the original frequency display.



## 2. Auto Presetting

This function automatically scans the AM and FM band and enters all stations with proper signal strength into the memory.

1. Select the FM band with the **BAND** button ⑥.
2. Tune in the lowest receivable frequency.
3. While pressing the **MEMO** button ⑧, turn the **GYRO TUNING** knob ⑫ to up. Auto memory starts at this point.
4. "AUTO PRESET" will show on the display.
5. Each time the tuner finds a station, the scanning will pause and the station will be played for five seconds. During this time, the following operations are possible:
  - 1) The band can be changed using the **BAND** button ⑥.
  - 2) The mode can be changed using the **FM MODE** button ⑦.
6. If no button is pressed during this period, the current frequency is preset in location CH-2. If you wish to skip the current station, turn the **GYRO TUNING** knob ⑫ during this period, the current frequency is skipped and auto presetting continues.
7. Operation stops automatically when all 50 preset memory positions are filled or when auto scanning attains the highest end of all bands. To stop the auto preset function at anytime, press the **CL** (CLEAR) button ⑨.

## 3. Recalling a Preset Station

1. Press the **PRESET** button ⑱ to change the display to preset.
2. Select the desired preset station by turning **GYRO TUNING** knob ⑫ on the front panel or press **◀** or **▶** button ⑮ of Tuner mode on the remote.

### Note;

- Direct selection method using the ten keypad on the remote, select the desired preset station by entering one or two digits using the ten keypad on page of keypad mode on the remote.
- To return to the Manual Tuning mode, press the **AUTO TUNING** button ⑰.

## 4. Preset Scan Tuning (Using the remote control unit)

1. Press the **SCAN** button (D8) on page 1 of Tune mode on the remote. "P-SCAN" shows on the display. (The preset station with the smallest preset number is recalled first. If no stations have been preset, CH "00" blinks in the display and the unit returns to the previous mode.)
2. Preset stations are recalled in sequence (CH-1 > CH-2, etc.) for 5 seconds each. Preset numbers that do not contain stations are skipped.
3. You can fast forward the preset stations by pressing the **▶▶** button continuously. When the desired preset station is received, cancel the preset scan operation by pressing the **◀◀** button or the **SCAN** button (D8) or **C** button of Tuner mode.

## 5. Clearing Preset Stations

You can remove preset stations from memory using the following procedure.

1. Recall the preset number to be cleared with the method described in "Recalling" a preset station.
2. Press the **MEMO** button ⑧ on the front panel or **M** (MEMO) button ⑬ of Tuner mode on the remote unit, "PRESET- -" blinks in the display for 5 seconds. While this is still blinking, press the **CL** (CLEAR) button ⑨ on the front panel or **C** (CLEAR) button ⑭ of Tuner mode on the remote unit. "CLEAR" appears on the display to indicate that the specified preset number has been cleared.

## STATION NAME PRESET

The station name preset function allows the name of each preset channel to be entered using alphanumeric characters. The Station Name button is valid only in the tuner mode. Before station name preset operation, store stations with the preset memory operation.

1. Press the **MEMO** button ⑧ on the front panel or **M** button ⑬ of Tuner mode on the remote for more than 3 seconds.
2. The left most column of the station name indicator flashes, indicating the character entry ready status.

### [Operation (Using the SR-19EX)]

3. When the **GYRO TUNING** knob ⑫ is turned, alphabetic and numeric characters will be displayed in the following order:  
**A → B → C ...Z → 1 → 2 → 3.... 0 → - → + → / → (Blank) → A**  
**UP →**  
**← DOWN**
4. After selecting the first character to be entered, press the **MEMO** button ⑧. The entry in this column is fixed and the next column starts to flash. Fill the next column and press the **MEMO** button ⑧ for more than 1 second to confirm the entry.

### Note:

Unused columns should be filled by entering blanks.

### [Operation (Using the remote unit)]

First, press the TUNER button on the remote control unit.

(This operation is not necessary if the remote control unit has already been operated in the TUNER mode.)

3. Enter the character using the ten keypad ⑫. For example, to enter "A":
  - 1) Press the "1" button. "A" appears on the display column.
  - 2) Every time the 1 button is pressed, the displayed character changes in the order: A → B → C → 1 → A...
 Pressing buttons other than the "1" button cause different characters to be displayed in a similar way, so that other alphanumeric characters can be entered. To enter a blank or space, press the "9" button.
4. When the desired character is displayed, press the **M** (MEMO) button ⑬ to confirm the entry in this column and move to the next column. After having filled all of the 8 columns, press the **M** (MEMO) button ⑬, for more than 1 second to confirm the entry.

## DIRECT FREQUENCY CALL

1. Press the **F/P** button (D7) on page 1 of Tuner mode on the remote.
2. Front display will show "FREQ ----".
3. Input your desired frequency with Ten keypad button on the remote.

## PLAYBACK OPERATION

### NORMAL PLAYBACK

1. Press the POWER ON button on the remote.
2. Turn the **INPUT SELECTOR** ⑲ on the front panel or press the **FUNCTION** button ⑨ on the remote unit to select an input source.
3. Press the Surround mode buttons ③ on the front panel or Surround mode buttons **D1** to **D8** on page 1 in the AMP MODE on the remote unit to select the desired surround mode.
4. Adjust the volume level using the **VOLUME** knob ⑯ on the front panel or press the **VOL + / -** button ⑩ on the remote. If necessary, adjust the tone using the **BASS** and **TREBLE** buttons **D1** to **D4** on page 3 in the AMP MODE on the remote unit.

### LISTENING TO A DIFFERENT AUDIO SOURCE WHILE WATCHING A VIDEO SOURCE (Using the remote control unit)

1. Select one of the following video sources TV, LD, DVD, VCR1, DSS/VCR2 or AUX.
2. Next, select one of the following audio sources FM, AM, CD, TAPE, or CDR/MD.

# OTHER FUNCTIONS

## MULTI ROOM SELECTOR

The Multi Room Selector is a function which allows you to listen to the same or a different source in a room other than the room in which the SR-19EX is located. To use this function, a multi room remote unit and remote control signal receiver available from your Marantz dealer are necessary. The operations possible with the multi room function are explained briefly below. For details, refer to the instruction manual supplied with the multi room remote control unit and receiver.

### MULTI ROOM SELECTOR OPERATION

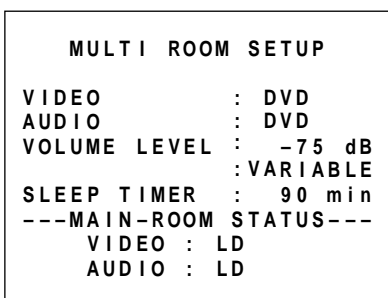
1. Press the **MULTI** button (19). The unit enters multi room mode and the display indicates "SELCT SOURCE" and flashes the "MULTI" indicator for approx. 10 seconds. In this time, you can select the input source by turning the **INPUT SELECTOR** knob (15).
2. Then, the display indicates "MULTI VOL" "VOLUME xx dB" for approx. 5 seconds. During this time, you can set the volume level for the multi room operation. This will only set the volume in the second room.

### MULTI ROOM SELECTOR OPERATION (USING THE MULTI ROOM REMOTE CONTROL UNIT)

1. Press the **MULTI** button, the **POWER ON** button, or select the desired source on multi room remote control unit from the MULTI ROOM. Any of these operations will put the SR-19EX into multi room mode and "MULTI" will light in the display.
2. Press the **VOLUME +** or **VOLUME -** button on the multi room remote control unit to set the desired sound volume.
3. In multi room mode, the multi room remote control unit can be used in the multi room to operate the following functions. You can select a tuner preset channel and tuning up or down, and direct frequency selection. And you can control the CD player LD player, DVD player and other source connected to the SR-19EX.

**Caution:**

- Multi room mode can only be selected when the SR-19EX **POWER** switch (1) is turned on.
- If the main room is active (not standby mode), you cannot select a radio band except the band of the main room. For example; if the FM band is selected in the main room, you cannot select the AM band in the multi room.
- The operating procedure for this is the same as the Multi-room operations using the remote unit.
- If you operate from second room, SR-19EX will output video signal with OSD information.



### DIALOGUE NORMALIZATION MESSAGE

Dialogue Normalization (Dial Norm) is a feature of Dolby Digital. When playing back software which has been encoded in Dolby Digital, sometimes you may see a brief message in the front panel display which will read "Dial Norm X dB" (X being a numeric value). Dialogue Normalization serves to let you know if the source material has been recorded at a higher or lower level than usual. For example, if you see the following message: "Dial Norm + 4 dB" in the front panel display, to keep the overall output level constant just turn down the volume control by 4 dB. In other words, the source material that you are listening to has been recorded 4 dB louder than usual. If you do not see a message or see "Dial Norm 0 dB" in the front panel display, then no adjustment of the volume control is necessary.

## TV AUTO ON/OFF FUNCTION

This function allows the component connected to the TV IN jack to control the power (ON/OFF) to the SR-19EX.

### AUTO POWER ON

1. Be sure TV auto mode is on. (Refer page 18 : System Setup 1/2 )
2. Connect your TV TUNER (etc) to the TV IN terminal. Be sure to connect the video input.
3. Turn OFF the power to the TV TUNER and the SR-19EX.
4. Turn ON the TV TUNER and tune in a receivable station.
5. When the station is received, the SR-19EX turns ON and TV is selected automatically.

### AUTO POWER OFF

1. In the above situation, turn the TV TUNER OFF or select a channel that does not contain any broadcast.
2. The power to the SR-19EX switches to STANDBY after approx. 5 minutes.

**Note:**

- AUTO POWER OFF is canceled if the **INPUT SELECTOR** knob (15) is set to a source other than TV. The function reactivates when TV is selected again.

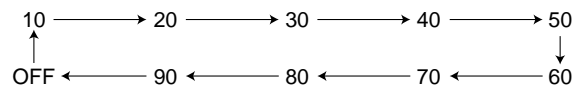
**Caution:**

- Some TV broadcasts may cause the TV AUTO FUNCTION to turn ON. To set this function ON/OFF, refer to the SETUP MENU.

## SETTING THE SLEEP TIMER (ONLY REMOTE CONTROL UNIT)

Set the sleep timer while the power is turned on.

1. Turn the power ON and press the **SLEEP** button (D5) on page 4 at AMP mode. "SLEEP" blinks on the display.
2. Press the **SLEEP** button (D5) the number of times to set the desired sleep time. Each press of the **SLEEP** button (D5) changes the display in the following order:



"SLEEP" stops blinking and lights steadily.

- \* While the sleep timer is activated, the remaining time can be displayed for approx. 2 seconds by pressing the **SLEEP** button (D5).
- \* To cancel the sleep timer, select "SLEEP OFF" by pressing the **SLEEP** button (D5).

This operating procedure is same for Multi room sleep timer from second room.

# REMOTE CONTROL UNIT RC-18SR

• The remote control unit provided with the SR-19EX is a “learning”-type, programmable unit capable of controlling almost any component in your system, as well as the Marantz D-BUS components (RC-5). The components to be controlled can be selected with 11 function buttons.

## OPERATION

The provided remote control unit (RC-18SR) is a system remote controller. The **POWER** button [4], 10-key numeric buttons [12] and control buttons [15] are used in common across different input source components.

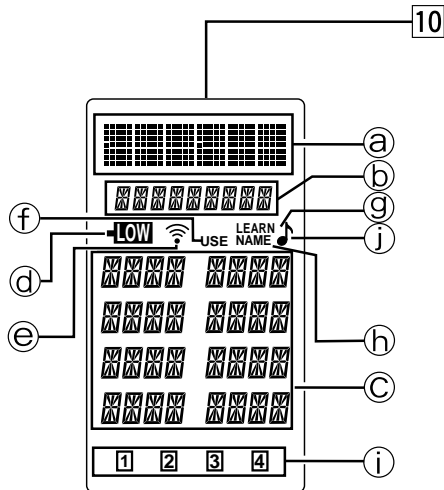
The input source system controlled with the RC-18SR changes when one of the input selector buttons [9] is pressed.

• Example: To select the LD player as the input source and play an LD on it

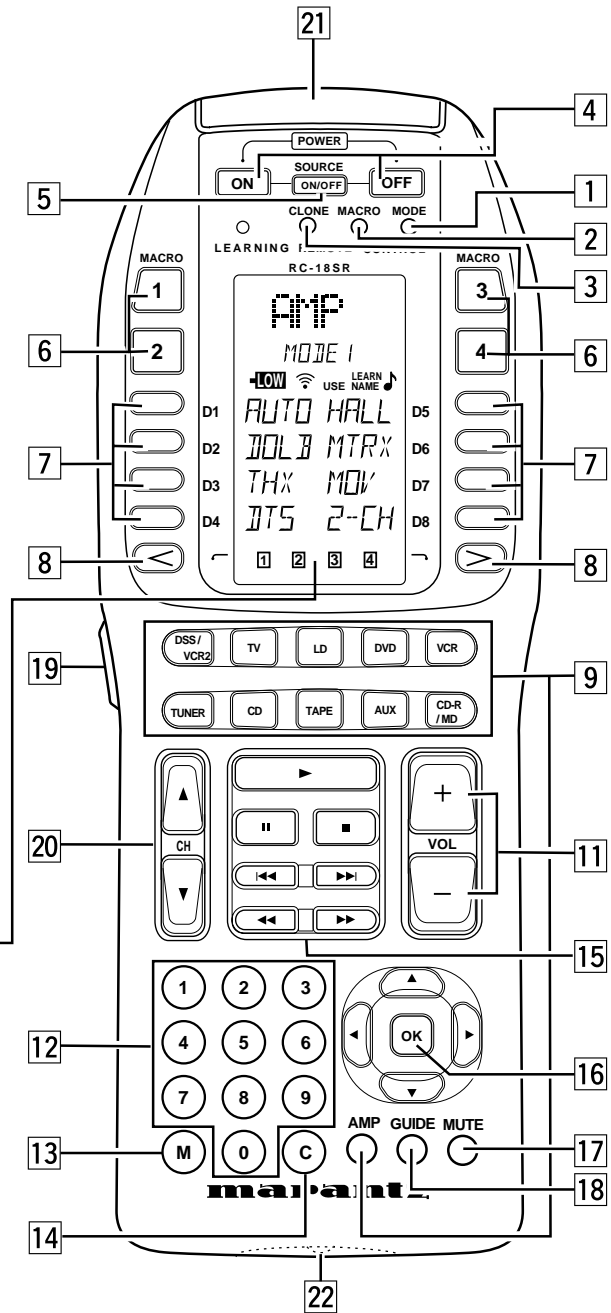
Press the **LD** button twice within 2 seconds.

The input function of the SR-19EX is switched to LD and the RC-18SR is set for control of the LD player.

Press the **PLAY** ► button [15] to play an LD.



## FUNCTION AND OPERATION



### 1 MODE (operating mode)

This button is used to change from normal operation to the learning mode, and is used when “learning” commands from other brands of A/V components. Each time this button is pressed (using a small pointed instrument, such as the tip of a paper clip) the mode changes as follows: LEARN → USE → NAME. As the mode changes, the LCD display will show which mode is currently selected.

### 2 MACRO (for multiple step macro functions)

This button is used to memorize a series of functions. When this button is pressed, the RC-18SR changes to macro programming mode, and is ready to learn a sequence of remote control commands.

**3 CLONE**

The RC-18SR has the ability to “replicate” itself, downloading all of its internal pre-programmed and user-programmed commands to another RC-18SR or RC2000MKII. This button is used when you wish to “teach” another RC-18SR or RC2000MKII all of the customized commands you’ve already programmed in this RC-18SR.

**4 POWER ON and OFF**

These two buttons are used to turn the main component’s (amplifier or receiver) AC power on and off. We provide both ON and OFF commands so that your A/V system is remote compatible with external infrared controllers, such as in-wall key pads, etc.

**5 SOURCE ON/OFF**

This button is used to turn the AC power on and off to any of your A/V source components that have their own remote control turn-on and turn-off commands, such as TV, laser disc player, VCR, and etc.

**6 MACRO 1-4**

Each of these 4 buttons can be programmed with a “string” of commands, called a macro, to initiate a sequence of remote codes to achieve a particular result. For example, a macro button could be programmed to turn on the main system power, then turn on a particular source component (such as a laser disc player), then turn on the TV set, set the TV to AUX video input, and then adjust the surround processor to the home theater surround decoding mode, then activate the laser disc player’s PLAY function. This means that by pressing one macro button, you can achieve the same result as pushing up to 20 buttons in sequence.

**7 DIRECT**

With today’s high performance A/V systems, it is not unusual for each component in your system to have dozens of specialized command functions. If we were to duplicate all of those commands for each component onto the RC-18SR key pad, we could easily exceed 300 buttons for an entire home theater system, which would result in either a huge key pad, or buttons of infinitesimal size. The DIRECT command buttons (4 on each side of the LCD display, 8 total) work with the PAGE buttons (4 pages for each source component) to provide up to 32 dedicated specialized functions for each of the 11 function input selectors. Each DIRECT function may also be provided with an alpha-numeric function indicator visible in the LCD display. You may even change the displayed name of each function to another name, if you wish.

**8 PAGE**

Used to select any 1 of the 4 pages of 8 functions for each DIRECT button, as explained above.

**9 FUNCTION**

Press one of these buttons once or twice to select a particular source component. For example, to set the amplifier or receiver to the laser disc input, press the LD button twice within 2 seconds. Along with the source selection, special functions may become available (the DIRECT keys), as well as activating the transport function keys, so that you can now directly operate the laser disc player from the RC-18SR. If you wish, you may even re-program the status indicators in the LCD window to reflect your own particular function name whenever that source (function) button is selected.

**Here are the button names and their functions:**

<b>LD</b>	: Laser disc player
<b>TV</b>	: Television
<b>VCR1</b>	: Video cassette recorder
<b>DSS/VCR2</b>	: Digital satellite decoder or second video cassette recorder
<b>AUX</b>	: Can be used for an auxiliary source component
<b>TUNER</b>	: AM/FM tuner, or AM/FM tuner section of a receiver
<b>CD</b>	: Compact disc player or changer
<b>TAPE</b>	: Audio tape deck, or digital audio recorder
<b>AMP</b>	: Amplifier or receiver control functions
<b>DVD</b>	: Digital video disc player
<b>CD-R/MD</b>	: CD-Recorder or mini disc player

**Note:**

Press a function selector button only once to select the LD player, etc. Remember, when you press a function selector button only once, the RC-18SR will not send out a remote control code to instruct the amplifier or receiver to change to that corresponding input, but the RC-18SR keypad and DIRECT function commands will provide the selected component’s specialized remote control codes. Press a function selector button twice within 2 seconds to change the function of the amplifier or receiver.

For example, if you press the LD function button twice within 2 seconds, the amplifier or receiver’s input will immediately be switched to the laser disc input, and the keypad and DIRECT function commands for laser disc operation will be activated. Press the CD function button only once, the amplifier or receiver’s input will not switch to the CD input, however the RC-18SR keypad and DIRECT function commands for compact disc operation will be activated.

We have provided 11 popular function command selector buttons, based upon the typical input selections available with most quality A/V amplifiers (or receivers) including popular Marantz models.

The function button DSS/VCR2 is a little different from the others, in that when you press this button, the RC-18SR will send out a command to the amplifier or receiver to switch to the DSS input, and then the RC-18SR keypad and DIRECT function commands will be configured for DSS (digital satellite system) control. We have included DSS commands within the RC-18SR’s pre-programmed memory for RCA brand DSS equipment. If you have another brand of DSS, you can “teach” the RC-18SR with the remote control codes of your equipment.

**10 LCD window**

The LCD window provides a wealth of information, including function selection name, DIRECT function names, learning and programming steps, as well as useful indicators for battery status, and other helpful indicators. The LCD window features back-lighting, making it easy to view when the room light is very low.

**11 Volume up (+) and down (-)**

Used to raise and lower the main system volume level. Note that these buttons are clearly the largest size, and are conveniently located and contoured for easy operation, even in low lighting.

**12 Ten keypad**

Like a telephone key pad, the ten number buttons (0-9) are used to enter numeric digits. They are useful for finding a specific track on a CD, or to tune a pre-set radio station, etc. The “0” button performs the same operation as the “CLEAR” button on the SR-19EX main unit.

**13 MEMO**

This button is used to program your CD player’s track memory, or to enter a VCR recording program, and can be used to provide the MEMO function included with other components in your system.

**14 CLEAR**

This button is used to cancel certain memory or programming operations. It operates differently from the “CLEAR” button on the SR-19EX main unit.

**15 Transport control functions**

These buttons provide transport commands for your source components, such as laser disc player, CD player, VCR, audio tape deck, etc., and are dependent on the function source selected. For example, when the RC-18SR is set to LD (laser disc) mode, the transport keys will operate the laser disc player’s PLAY, STOP, PAUSE, FAST FORWARD, FAST REVERSE, NEXT and PREVIOUS track functions. Change the RC-18SR function selector to VCR, and these keys will then operate the VCR’s transport command functions, etc.

**16 CURSOR buttons**

Some components feature menus that are navigated with up, down, left and right direction commands. The cursor buttons can be used to navigate within on-screen menus, for components such as amplifier or receiver, TV set, DSS/satellite tuner, etc. These buttons are also used for certain RC-18SR programming functions.

**17 MUTE**

For those components (such as amplifier or receiver, TV, etc.) with a mute function, this button can be used to mute the sound temporarily.

**18 GUIDE**

This button is intended for owners of DSS (digital satellite system) or similar equipment, to activate the on-screen programming guide, used when changing channels, etc.

**19 LIGHTING**

Press this button to activate the back-lit LCD screen and back-lit keys independently SETUP mode. A quick touch is all that is necessary. The back-lighting will remain on for 3 seconds. If you wish, you can even re-program the RC-18SR to shorten or lengthen the amount of time the back-lighting is activated when this button is pressed.

**20 Channel up(▲), down(▼)**

Press this button to change the tuner, TV, DSS or VCR preset channels to upward or downward.

**21 Transmitter window**

Infrared signals will emanate from behind this window. Simply aim the RC-18SR towards the component(s) you wish to control. You may find that the RC-18SR works fine when placed on a coffee table pointing towards your A/V system components.

**22 Receiving window**

Used when learning commands from other remotes, this window is placed at the bottom of the RC-18SR, so that the two remotes are vertically oriented for easy transfer of remote control information. Later in this guide we will show you which of the RC-18SR buttons can be "taught" new commands from other components.

**LIQUID CRYSTAL DISPLAY (LCD) WINDOW**

Within this display, all operating messages (function name, mode names, etc.) are shown. When a particular button is pressed (such as a transport command, like PLAY), its status will be shown in the display for 1 minute. The display will continue to show the source function selected continuously, however.

**Ⓐ Function indication:**

The selected source function is displayed, such as LD, TV, etc., up to 6 characters maximum.

**Ⓑ Status indication:**

The selected status of the present page, or other items, is displayed, up to 9 characters maximum.

**Ⓒ Direct commands:**

8 DIRECT commands are available in 1 page, up to 4 characters maximum.

**Ⓓ Battery indicator:**

When the batteries are running low, this indicator will become visible. At this point, it will not be possible to learn any new remote codes, but normal remote control operation is still provided (including the use of any previously learned codes). At this point, you should consider changing the batteries soon. As time goes on, and the battery power diminishes further, this indicator will begin blinking. At this point, no remote commands will be transmitted. This is your signal to replace the batteries with fresh ones as soon as possible. Eventually, if you ignore the blinking battery indicator and do not install fresh batteries, then the batteries may eventually be totally exhausted, and the LCD display window will be completely blank. However, any previously learned commands and macros will not be erased from the microprocessor's memory.

The RC-18SR is supplied with a full set of RC-5 remote control codes in permanent (non-volatile) memory. Even if the batteries are fully exhausted, the RC-5 codes (used for Marantz A/V components) and learned codes will never disappear.

We recommend that you use a quality brand of alkaline batteries, for best results and longest life. Newly available lithium "AA" batteries can even provide longer life than alkaline batteries, and are also recommended.

**Ⓔ Transmit indicator:**

When a button is pressed, this indicator shows that an infrared code is being transmitted.

**Ⓕ USE indicator:**

For normal operation, the USE indicator should be visible.

**Ⓖ LEARN indicator:**

Visible when the RC-18SR is set to LEARN mode.

**Ⓗ NAME indicator:**

Visible when the RC-18SR is in the learning mode, and function naming is being changed.

**Ⓘ PAGE or MACRO indicator:**

This indicator usually functions in association with a **PAGE** button **[8]**, but also functions as the MACRO indicator when a **MACRO** button **[6]** is pressed.

**Ⓜ J indicator:**

Visible when the RC-18SR is set to the beep function.

**Installing the batteries:**

The battery compartment is located on the rear panel. Please use only alkaline or lithium batteries, "AA" size. The RC-18SR requires four AA batteries. There are markings in the battery compartment to show you the proper battery orientation. If after installing the batteries, you cannot see any indication in the LCD window when a button is pressed, re-check to ensure that the batteries are properly positioned in the compartment.


## RC-18SR BASIC OPERATION

### USE Mode:

As supplied from the factory, the RC-18SR is already permanently programmed with many pre-set commands common to Marantz and Philips equipment, as well as other brands of components that utilize the Philips RC-5 remote control language.

1. If the RC-18SR is in another mode (LEARN, etc.), press the operation mode button [1] with the tip of a paper clip, until the USE indication appears.
2. Press one of the function buttons [9], to change to another component's commands such as LD (refer to Figure 1).



3. "LD" will be indicated within the LCD window, and the function codes will be set to operate the laser disc player. Press the function button again within 2 seconds and the amplifier or receiver's input changes to laser disc.
4. Now you can operate the laser disc player. When a button is pressed, the  symbol indicates that a remote code is being transmitted. Note that for a particular source component, not every button may have a command programmed for it. In that case, nothing would be indicated.
5. Using the **DIRECT** buttons D-1 through D-8 and PAGEs 1 through 4, up to 32 different specialized commands are available for each FUNCTION, up to a total of 352 specialized commands (32 direct commands times 11 functions). Note that for any particular function selector, not all 32 direct commands may be provided and/or named as supplied from the factory.
6. For example, the RC-18SR is supplied from the factory with 3 pages of DIRECT commands for the LD (laser disc) function. To change pages, press the page direction ◀ or ▶ buttons [8]:

**Page 1: MODE:** Side A/B laser disc playback functions

**Page 2: L D:** Specialized laser disc functions

**Page 3: R E C:** Recording from laser disc to VCR functions

At this point, you may wish to put this guide aside temporarily, and begin using the RC-18SR with your A/V system. If you already have any Marantz components, or Philips and/or other brands of components that use the RC-5 remote control language, you can begin controlling those components with the RC-18SR right away. Take some time to become comfortable with the operation of the RC-18SR. We think that its intuitive key pad layout and easy to read LCD window will permit you to quickly become familiar with its operation.

If you do not have any Marantz or other brands of components that use the Philips RC-5 remote control language, then you may wish to proceed to the next section, which will describe the steps necessary to "teach" your RC-18SR remote codes from other components you may have in your system.

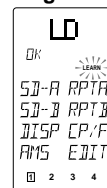
### LEARN mode:

The RC-18SR has the ability to learn remote codes for just about any component in your A/V system. If the original component was supplied with an infrared remote control, its commands can be learned by the RC-18SR. If you have another brand of laser disc player, for example, you can program the RC-18SR with its codes. For example, we'll show you how to "teach" the RC-18SR commands from another brand of laser disc player.

1. Using a sharp point (such as the tip of a paper clip), press the operation **MODE** button [1]. Each time you press the button, the mode within the LCD display, the LEARN indicator will begin blinking.
2. Place the laser disc player's supplied infrared remote controller so that its transmitter window (usually at the top) is facing the receiving infrared sensor window [22] of the RC-18SR (at the bottom), about 5 cm (2 inches) apart.

3. Press the LD function button on the RC-18SR.
4. Press the play button [15] on the RC-18SR.
5. Press and hold the corresponding **PLAY** button on the laser disc player's remote transmitter until the "OK" indicator appears in the RC-18SR LCD window (see Figure 2) or the beep sounds emit (if the beep sound function is set).

**Figure 2**



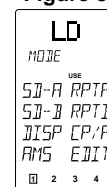
If the "AGAIN" indicator appears in the RC-18SR LCD window, it means that for some reason the command was not properly learned. Repeat steps 3, 4 and 5 above.

In the unlikely event that an infrared command cannot be learned by the RC-18SR, "NG" (no good) will appear in the LCD window, meaning that the command is not "learnable". The RC-18SR has been tested for compatibility with a very wide range of infrared remote control frequencies and data word lengths, but in some very rare instances, it may not be possible to learn a particular remote control command.

Continue to "teach" the RC-18SR the rest of the source transmitter's transport function commands, such as **STOP**, **PAUSE**, **NEXT**, **PREVIOUS**, **FAST FORWARD** and **REWIND**, by repeating steps 3, 4 and 5 above.

6. Proceed to learn the numeric "10 keys" from the source transmitter to the RC-18SR's 10 key numeric pad [12] by repeating steps 3, 4 and 5 above.
7. For each additional function, such as TV, VCR, etc., repeat steps 3, 4 and 5 above. During the LEARN operation, if any button is not pressed within 1 minute, the RC-18SR will revert back to the previous operating mode.
  - To make a function button learn a code, switch the input function then press the button again.
8. After memorizing all desired remote codes, press the operation mode button [1] with the tip of a paper clip, and select the USE mode. The LCD display window will continue to display the USE indicator, and all of the newly memorized codes will be available (see Figure 3).

**Figure 3**



For any button for which a new code was not learned, the factory programmed RC-5 code will still transmit as usual.

### Note:

**POWER ON/OFF** [4] code can be learned regardless of the function button selection:

### Programming the DIRECT mode buttons [7]:

The following example will show how to memorize the SIDE-A function command of another brand of laser disc player into the D1 direct button.

1. Using a sharp point (such as the tip of a paper clip), press the operation **MODE** button [1] to switch the RC-18SR to LEARN mode.
2. Place the laser disc player's supplied infrared remote controller so that its transmitter window is facing the receiving infrared sensor window [22] of the RC-18SR about 5 cm (2 inches) apart.
3. Press the LD function button [9] on the RC-18SR.
4. Using the direct function page keys ◀ and ▶ [8], set the direct function to Page 1. Press the **D-1** button [7] on the RC-18SR.

- Press and hold the corresponding SIDE-A button on the laser disc player's remote transmitter until the head of name blinks in the RC-18SR LCD window or beep sounds emit. The RC-18SR changes to the RENAME mode automatically as the next step. A function name of the **DIRECT** function button blinks, you can rename this blinking function name. You input the desired letter or number with the ten keypad. (See the table in step 3 of the next procedure for reference.) If you need not rename, press the **OK** button or the other buttons except the ten keypad.
- Now, proceed to program the other commands from the laser disc player's remote transmitter to the other **DIRECT** function buttons (D2-D8). When you have "taught" all 8 direct functions for Page 1, press the page direction key **▶** **[8]** to go to Page 2, and you can program more direct function keys.
- After memorizing all codes to all **DIRECT** function buttons, press the operation **MODE** button **[1]** with the tip of a paper clip and return the RC-18SR to the USE mode. Now, the newly memorized codes are usable from the RC-18SR.

If you wish, you can re-write the names for each function name, status name, and the direct function command names as follows:

For our example, you can change the LCD display window indication from "LD" to "LV-520" (which is the model number for a Marantz laser disc player). Remember, you can re-name a function selector button with a new name of up to six characters of letters and numbers in any combination.

- Using the tip of a paper clip, press the operation **MODE** button **[1]** until the NAME indicator appears and begins to blink in the LCD window.
- Choose a button that you wish to re-name, in this case, press the "**LD**" function button **[9]**. In the LCD window, the first character of the six function character display indicators starts blinking "A", which is the first letter of the alphabet if you press "1" button twice.
- Choose the desired letter or number by pressing the 10 keypad buttons **[12]**. Each 10 keypad button has 4 characters attached to it as follows:

10 keypad button	Press, press again, press again, etc.
1	1 → A → B → C → 1 → .....
2	2 → D → E → F → 2 → .....
3	3 → G → H → I → 3 → .....
4	4 → J → K → L → 4 → .....
5	5 → M → N → O → 5 → .....
6	6 → P → Q → R → 6 → .....
7	7 → S → T → U → 7 → .....
8	8 → V → W → X → 8 → .....
9	9 → Y → Z → / → 9 → .....
0	0 → + → - → SPACE → , → ' → 0 .....

So, in the above example, by pressing the 10 keypad number 4 four times, you get the letter "L" to appear in the display (see Figure 4).



- You use the cursor buttons **◀** and **▶** **[16]** to move to the next character in the display. By pressing the right cursor button **▶**, the letter "L" is confirmed in the first character space in the LCD window and the next character position begins blinking. If you wish to erase a previously memorized character, position the cursor over the character and put the SPACE character in its place (the SPACE character is ten keypad number 0 pressed four times, from the above character chart).

- Continuing along, re-write the remaining letters "V", "-", "5", "2", and "0". By pressing the cursor keys **◀** and **▶**, each character is confirmed in place. When you go to other **DIRECT** function pages by using the page function keys **[8]**, characters in the previous page are also confirmed in place. The name re-writing operation must be done on a function by function basis, that is, re-write the names for all of the **LD** direct functions, then switch to another function such as **VCR**, and begin the re-writing process anew to re-name the **VCR** direct function commands. After completing all re-writing of any of the names, press the **OK** button within the cursor keys **[16]**.

**How to re-write the STATUS name:**

Using the same steps as outlined above, you can re-write the 9 character status name. During step 5 above, by pressing the up and down cursor keys **[16]** the left side of the status indicator begins blinking, and you can change its display according to the same method outlined above, using the 10 keypad character generator. Remember, to confirm each character change, use the cursor keys **◀** and **▶**. As above, when you change the direct function page by pressing the page direction keys **[8]**, this will confirm the re-written characters in place as well for the page you just finished re-naming. You have up to 9 letters, numbers or other characters available for each status name.

**How to re-write the DIRECT function button names:**

You can change the name for each of the 8 direct function buttons by using the steps described above to change main function name and status name. Remember, each main function has 8 direct function buttons on each of the 4 pages, so you have up to 32 direct functions that can be re-named, if you wish, for each of the 11 main function selection buttons **[9]**. You have up to 4 characters available for each direct function button name.

After completing all re-writing of any of the names, press the **OK** button within the cursor keys **[16]**, or switch to another function button (such as CD). If, during re-naming, a button has not been pressed for 1 minute, the RC-18SR will revert to the prior operating mode (USE) automatically.

If re-writing of all of the desired direct mode functions has been completed, use the tip of a paper clip to press the operation **MODE** button **[1]**, and select the "USE" mode. Now, all of the re-written names are available for use.

**How to clear (erase) the memorized codes**

**(and any re-written names):**

The RC-18SR has a high capacity RAM, which ordinarily will allow the learning of several hundred remote codes (and their associated new names, if desired). However, due to the fact that some remote codes occupy more memory space than others, it is possible that the available RAM fills up completely, and the "FULL" indicator appears in the LCD window. In this case, it will not be possible to learn any new remote codes without first deleting some or all of the previously learned remote codes and/or re-written names. There are 4 ways to erase learned remote codes from memory:

- Erasing by button(s)
- Erasing by DIRECT button(s)
- Erasing by function(s)
- Erasing all memory contents (complete erasure)
- Note that the factory-programmed RC-5 codes are not stored in RAM, and are therefore not erasable.

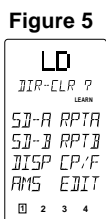
For any of these memory erasure options, you must first set the RC-18SR to LEARN mode.

**Erasing the memory assigned to a particular button:**

Press and hold the **CLEAR** button **[14]** and press the button that you wish to erase 2 times. The code previously learned by that button will be erased, and will then be either empty, or the original factory provided RC-5 code will re-appear in its place.

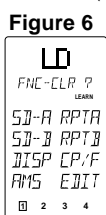
### Erasing the memory assigned to a DIRECT buttons:

All codes and names which were previously memorized for each of the functions (such as TV, LD, VCR, etc.) in pages can be erased. Press and hold the **CLEAR** button [14] and press the < or > button [8] 2 times. You will see the "DIR- CLR?" (direct button - clear?) indication in the LCD window (see Figure 5). If you wish to go ahead and clear all of the memorized codes for that **DIRECT** button (8 buttons x 4), press the **OK** button



### Erasing the memory assigned to each function command set:

All codes and names which were previously memorized for each of the functions (such as TV, LD, VCR, etc.) can be erased. Press and hold the **CLEAR** button [14], and press the function button that you want to erase 2 times. You will see the "FNC - CLR?" (function - clear?) indication in the LCD window (see Figure 6).

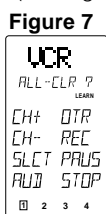


If you wish to go ahead and clear all of the memorized codes for that function button, press the **OK** button within the cursor keys [16]. After clearing the memory contents for that function, the RC-18SR will restore any factory programmed RC-5 codes for the function, if any, or will simply be empty.

If you want to cancel the memory clear operation, do not press the "OK" button, but instead simply touch any other button. When you clear all the commands associated with a function button, all of the learned direct function commands (D-1 through D-8, pages 1 through 4) and control buttons, ten keypad, etc are cleared as well.

### Complete erasure:

While holding the **CLEAR** button [14] depressed, press both of the **ON** and **OFF POWER** buttons [4] simultaneously; "ALL-CLR?" is displayed on the LCD window (see Figure 7).



If you wish to finalize the complete erasure process, press the **OK** button within the cursor keys [16]. If you do not wish to proceed with the complete erasure process, simply press any key other than **OK**. Remember, the RC-5 codes as supplied from the factory cannot be erased from memory, but they can be replaced with different codes as you wish.

- The all-clear operation takes about 15 seconds after the **OK** button is pressed.
- By now, you have learned how to memorize codes from other brands of components, including changing the various function, status, and direct function names.

Before continuing on to the more advanced RC-18SR programming techniques, you may wish to continue "teaching" the RC-18SR remote control with any or all other commands for other components in your system. When you feel you've transferred as many different commands from other components into the RC-18SR as you'd like, and possibly changed some or all of their names as well, then feel free to proceed to the next section.

## ADVANCED PROGRAMMING TECHNIQUES

### Macro mode:

The word "macro" is used to describe a series of specific steps carried out in sequence. For example, a word processing program can use macros to carry out common repetitive typing tasks. During the day to day operation of an A/V system, you might often find yourself pressing the same combination of remote control buttons. The RC-18SR features the ability to "learn" a sequence of infrared commands, and "assign" that sequence to a single button, called a **MACRO** button [6]. Then, when you want to achieve a specific result, you can activate a macro button to begin sending out a series of commands. For example, suppose you wish to activate your A/V system, and watch a movie on laser disc. A single macro button could send out the following commands in this suggested sequence:

- Turn the main amp power on, then turn the TV power on, then switch the TV to the AUX video input, then change the amp to the laser disc (LD) input, then turn the LD player power on, then activate the LD play command, then set the amp surround sound mode to Dolby Pro Logic.

The above 7 step sequence can be programmed into a single macro button, and can be used anytime you want to watch a LD movie. Other macro functions could be used for CD listening, or any other sequence of steps that you regularly perform while controlling your A/V system.

Macro commands are available when the RC-18SR is set to USE mode.

To program a macro, first identify which commands you wish to memorize, and note if any commands must be in a specific order (for example, before you can activate an amplifier's surround mode, the amp must first be turned on).

1. Press the **MACRO** [2] operation mode button with the tip of a paper clip. Within the LCD window, the MACRO indication appears, then the LEARN indicator starts blinking (see Figure 8).

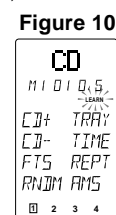


If a macro was previously programmed, one or more of the numeric indicators at the bottom of the LCD window will appear with a box around it.

2. Press macro button 1 [6] to begin memorizing the various codes. In the LCD display window the indicator "M1-00" appears in the status line (see Figure 9).



The "M1-00" indication signifies Macro number 1, no steps yet programmed. As each macro step is programmed, the "00" indicator will advance by one digit-"01", "02", etc. After the first macro step is programmed, two additional digits (with a decimal in between) become visible at the end of the status line, showing the timing value for each step (see Figure 10).





- Press the command buttons in the desired sequence. When you press a command button to be learned into the macro sequence, its name will appear within the LCD window. Every time you press another remote command, the macro step number increases one by one.
- It is possible during macro programming to adjust the timing of the interval between several macro steps. Using the cursor keys **[16]**, the interval between macro playback steps can be increased or decreased in 1/2 second steps, over the range beginning at 1/2 second up to 10 seconds. For example, when the indicator shows "0.5 SEC", if you press the **◀** direction key, the interval time would change to 10 seconds, then with another press of the **◀** direction key, it would change to 9.5 seconds, etc. Use the **▶** direction key to increase the interval time, and use the **◀** direction key to decrease the interval time.

Some equipment may not be able to receive infrared commands in one-half second steps. If after programming a macro you find that the sequence was not properly carried out, you may wish to experiment with different sequence timings to obtain the correct operation results by using the adjustment method described above.

Within each macro button, up to 20 steps can be memorized. In the event that you wish to memorize more than 20 steps per macro, then press another **MACRO** button **[6]**, and follow the above operations. A maximum of 80 steps can be programmed this way. However, you will probably find that 20 steps is more than enough to carry out even the most complex macro instructions to achieve a specific home theater operating result.

#### Note:

To memorize the cursor button **[16]** except **OK** button, press and hold the **LIGHTING** button **[20]** before pressing the cursor button.

**When programming macro steps, note that the following buttons would not normally be included in a macro sequence, and are therefore not available for inclusion in a macro:**

MODE **[1]**, MACRO **[2]**, CLONE **[3]**, PAGE **[8]**, VOLUME **[11]**, MEMO **[13]**, CLEAR **[14]** and LIGHTING **[20]**.

To check to see which **MACRO** buttons **[6]** have been programmed with macros, at the beginning of the macro learning sequence the four numerical (1 through 4) indicators at the bottom of the LCD window will show a box around the number for each **MACRO** button that already has a macro assigned to it (see Figure 11, which shows that only **MACRO** button number 1 has a macro assigned to it).

Figure 11



In the event that you wish to revise a programmed macro sequence, search the step number you wish to change by using the cursor button **▲** and **▼** **[16]**, and then re-enter the new command. If you memorized different commands than have already been programmed, then the previous macro sequence will be erased and re-written over with the new sequence. To add the new command, press the **MEMO** button at your desired point. To delete the sequence, press the **CLEAR** button at your desired point.

During macro programming, if a button is not pressed within 1 minute, the mode will automatically revert to the original mode (USE). When you have completed the macro programming sequence, press the **MACRO** **[2]** operation button with the tip of a paper clip. The "END" indication appears in the LCD display window. When you release the **MACRO** button, all indications will revert to the initial status.

There is one more important point to note about programming a macro sequence. During a macro sequence, you may include more than one function selection button to access some transport and/or other commands. Depending on the macro sequence, this might result in the amplifier or receiver's function selection to be

inadvertently changed as well when the macro is played back. The RC-18SR has a special feature to prevent this from occurring, allowing you to access the special commands available under each RC-18SR function button during a macro playback sequence, while at the same time preventing the amplifier or receiver from constantly switching its input source back and forth at the same time.

During the programming sequence, just remember that if you wish to activate a specific input selector on your amplifier or receiver, make sure that you press the desired input selection button **FIRST**. Subsequent function button selections can be incorporated in the macro sequence, but on playback, the RC-18SR will only send out a function selection infrared command to the amplifier or receiver based upon the first function command used in the macro sequence. For example, you may wish to have a macro sequence which activates the laser disc player input on your amplifier or receiver, and then have additional commands in the sequence to instruct your TV set to switch to an external video source to receive the laser disc video signal. During the macro programming, make sure that you press the **LD** function selector button **BEFORE** you press any of the other function selector buttons in the sequence. You can then include any of the TV commands by pressing the **TV** function selector button, later in the sequence. When this macro is next used (played back), the RC-18SR will send out the command to change the amplifier or receiver's input selector to laser disc input (since its function selector button was the first one programmed into that macro sequence), and will not subsequently change the amplifier or receiver's input to TV (but will send out any special TV commands that you included in the macro sequence).

#### Programming a macro under a function selector key:

If you wish, you can also program a macro that can be activated by pressing one of the function selector **[9]** keys. The programming steps are similar to the steps outlined for programming a macro number button **[6]**. The following example shows how to program a macro under the **LD** (laser disc) function selector **[9]**:

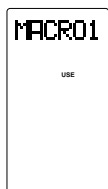
(activate the main amplifier's power on, switch the source to laser disc, switch the amplifier's surround mode to PRO LOGIC, switch on the television, switch to the television's AUX video input, power up the laser disc player, and begin laser disc playback)

- Press the **MACRO** **[2]** operation mode button with the tip of a paper clip.
- Press the **LD** function button **[9]**.
- Press the following buttons:  
POWER ON, LD, AMP, direct function D-2 (Dolby mode selector) in page 1, TV\*, SOURCE ON, direct function D-3 (VIDEO input selector) in page 1, LD\*, SOURCE ON, and PLAY.
- Press the **MACRO** **[2]** button with the tip of a paper clip. The RC-18SR will revert to the normal mode and save the macro under the **LD** function button.
- To execute the new macro sequence, press and hold the **LD** function selector button for 3 seconds.

**Using the macro function(s) you have programmed:**

1. Press the desired **MACRO** [6] button. The corresponding macro number will appear at the bottom of the display window, or if a macro has been programmed under a function button, press and hold that function button for 3 seconds. The LCD display window will indicate the macro number in the LCD window (see Figure 12), or if a macro is programmed under a function key, the status line will display the macro under function buttons as follows:

**Figure 12**



Macro under function button:	Status line shows:
LD	"LD" as the first 2 characters of the line
TV	"TV" as the first 2 characters of the line
VCR1	"VC" as the first 2 characters of the line
DSS/VCR2	"DS" as the first 2 characters of the line
AUX	"AX" as the first 2 characters of the line
TUNER	"TU" as the first 2 characters of the line
CD	"CD" as the first 2 characters of the line
TAPE	"TP" as the first 2 characters of the line
DVD	"DV" as the first 2 characters of the line
CD-R/MD	"CR" or "MD" as the first 2 characters of the line
AMP	"AP" as the first 2 characters of the line

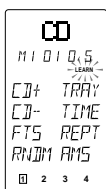
2. The macro sequence will begin, and the remote control codes will be sent from the RC-18SR and the display will show the names of the transmitted codes.
3. When the macro transmit sequence has ended, the RC-18SR will return to the same mode as before, then the macro function was initiated.

**Now that we've explained how to program a macro, perhaps the following suggested example can help you become more familiar with the process:**

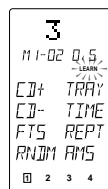
(to switch the RC-18SR to CD, then initiate CD playback, and go to track 3 on the CD)

1. Press the **MACRO** [2] operation mode button with the tip of a paper clip.
2. Press one of the **MACRO** buttons (1 through 4).
3. Press the following buttons:
  - CD function selector, then numeric key pad 3, then transport control key pad PLAY key. (see Figures 13, 14, and 15)

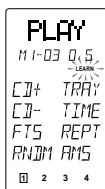
**Figure 13**



**Figure 14**



**Figure 15**



Note that this sequence will operate a Marantz CD player (or any other CD player equipped with the RC-5 remote control language). If you have another brand of CD player, you may wish to check its owner's manual to see if direct track selection is possible via remote, or if the macro sequence needs to be adjusted according to the programming steps required by your CD player.

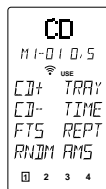
4. Press the **MACRO** [2] button with the tip of a paper clip. The RC-18SR will revert to the normal mode (see Figure 16).

**Figure 16**

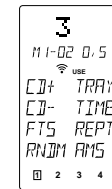


5. To execute the new macro sequence, press the appropriate **MACRO** button (1 through 4) that you chose at the beginning of the above programming sequence. (see Figures 17, 18, and 19)

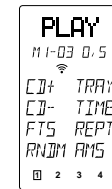
**Figure 17**



**Figure 18**



**Figure 19**



**Note:**

If you would like to cancel the MACRO function, press the **STOP** [15] button.

**Now, we'll show you another macro programming example, with a more sophisticated sequence:**

(activate the main amplifier's power on, switch the source to laser disc, switch the amplifier's surround mode to PRO LOGIC or Dolby Digital, switch on the television, switch to the television's AUX video input, power on the laser disc player, and begin laser disc playback).

1. Press the **MACRO** [2] operation mode button with the tip of a paper clip.
2. Press one of the **MACRO** buttons (1 through 4).
3. Press the following buttons: POWER ON, LD, AMP, direct function D-2 (Dolby mode) on page 1, TV\*, SOURCE ON, direct function D-3 (VIDEO input selector) on page 1, LD\*, SOURCE ON, and PLAY.
4. Press the **MACRO** [2] button with the tip of a paper clip. The RC-18SR will revert to the normal mode.
5. To execute the new macro sequence, press the appropriate **MACRO** button (1 through 4) that you chose at the beginning of the above programming sequence.
  - Note that the function selector buttons TV and LD marked with an asterisk (\*) in this macro sequence do not actually send out infrared codes, but simply change over the RC-18SR's programmed memory code banks for those respective functions.

If you would like to clear the MACRO programmed sequence(s), press and hold the **CLEAR** [14] button and simultaneously press the appropriate **MACRO** button (1 through 4) or function button. "MR1-CLR?" (macro 1-clear?) appears in the LCD window. Release the buttons, and then press the **OK** button (within the cursor control buttons), and the macro is erased. If you do not wish to erase the macro, simply press any other buttons (but not the **OK** button).

**CLONE mode:**

Duplicating the memory contents of one RC-18SR to another RC-18SR or RC2000MKII.

For a complete home theater system, with numerous components from many different manufacturers, you may find that you have stored dozens, even hundreds of different codes, along with specialized names, macros, etc. We have provided a very quick and simple procedure that allows you to download the entire customized memory contents of one RC-18SR remote control into another RC-18SR or RC2000MKII.

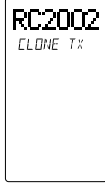
**To “clone” (duplicate) the memory contents of one RC-18SR into another RC-18SR or RC2000MKII, please follow these steps:**

1. Place the source RC-18SR (the one with all of the customized commands, names, macros, macro sequences, etc) with its infrared transmitter window [21] facing the receiving infrared sensor [22] of another “fresh” RC-18SR or RC2000MKII (5 cm, or 2 inches apart).
2. Press the **CLONE** button [3] of the source RC-18SR or RC2000MKII with the tip of a paper clip, and select “CLONE TX” (clone transmit) mode .

**Note:**

When using RC18SR, “RC2002” is displayed in LCD window. If the receiving remote control unit is RC2000MKII , then the display does not change. If the receiving remote control unit is RC-18SR, then the display is changed to “RC18SR” by pressing the cursor button ▲ [16]. (see Figure 20)

**Figure 20**



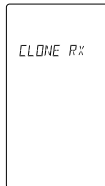
3. Press the **CLONE** button [3] of the learning (receiving) RC-18SR or RC2000MKII with the tip of a paper clip or a similar object, and select “**CLONE RX**” (clone receive mode).

When using RC18SR, “RC2002” is displayed in LCD window. If the transmitting remote control unit is RC2000MKII , then the display does not change. If the transmitting remote control unit is RC-18SR, then the display is changed to “RC18SR” by pressing the cursor button ▲ [16]. Then press the **PLAY** button [15].

**Note:**

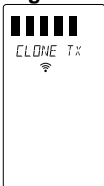
When the transmitting remote control unit is RC2000MKII , then All clone does not activate. To clone the Function key, press the each Function key except DSS/VCR2 and AMP keys. Eight keys can be cloned at once. If All clone activates without pressing the Function button, “N/A” will display and the clone is not performed. When the transmitting remote control unit is RC-18SR and receiving remote control unit is RC2000MKII, The DSS/VCR2, CD-R/MD and AMP keys cannot be cloned. To clone the Function key, press each Function key except DSS/VCR2, CD-R/MD and AMP keys.

**Figure 21**

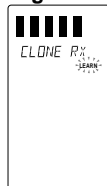


4. Press the source RC-18SR’s or RC2000MKII’s transport control **PLAY** [15] button to begin the infrared data transmission sequence. If you wish to duplicate only 1 to 8 function’s memory, press the function button(s) you wish before pressing the PLAY button. Now the “**LEARN**” indicator of receiving RC-18SR starts to blink. (see Figure 23)

**Figure 22**

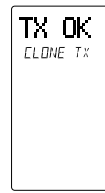


**Figure 23**

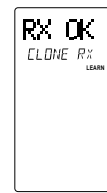


After all bars are lit up on both displays, “TX OK” (transmission OK) will appear in the source RC-18SR’s LCD window, and “RX OK” (reception OK) will appear in the “cloned” RC-18SR’s LCD window, confirming the end of the copying process (see Figures 24 and 25).

**Figure 24**



**Figure 25**



Please be sure that, during the copying process, neither RC-18SR is physically disturbed (ideally, they should be placed on a table or other surface, and not hand-held during the copying process). If, for some reason, the copying process was interrupted, the “clone” RC-18SR’s LCD display window will indicate “RX NG” (reception no good). Simply begin the clone process anew by repeating the above steps.

**Note:**

Cloning is only available between the same remote control unit series, therefore the RC-18SR cannot be cloned by the RC2000.

5. If the source RC-18SR’s memory contents are at or near full capacity, the copying process will take about 3 minutes. After completion of the copying (cloning) process, press the **CLONE** button [3] on both RC-18SR’s with the tip of a paper clip, and select the OFF mode.

Then, you’ll have two identically programmed RC-18SR remotes, one of which can again be used as your system’s primary remote control, and you’ll have the added confidence of knowing that in the event of inadvertent programming (or memory contents being cleared somehow), you can simply retrieve the “backup” RC-18SR that you’ve safely tucked away, and within minutes restore the programming contents of the original RC-18SR with your customized configuration.

**Note:**

Some direct keys are marked “♦” in Direct Command Functions Listing (page 32 to 35). The “♦” mark means as follows; When RC-18SR is cloned with RC2000MKII, the name of the direct key can be cloned, however the remote control code (the factory preset code) cannot be cloned. Only learned remote control codes can be cloned. Then the remote control code is learned by “LEARN mode”. Refer to page 25.

**The table of cloning relations**

Receiving \ Transmitting	RC-18SR	RC2000MKII
	RC-18SR	ALL OK
RC2000MKII	only FUNC.	ALL OK

ALL OK: All functions can be cloned.

only FUNC.: The following functions cannot be cloned;

- RC-18SR: DSS/VCR2, CD-R/MD, AMP
- RC2000MKII: DSS/MD, AMP

## OTHER FUNCTIONS

The Marantz RC-18SR includes the ability to tailor the lighting features according to your preferences. As supplied from the factory, the RC-18SR has lighting features (and lighting timings):

The lighting time is set at the factory for a period of 2 seconds which you can change if you prefer a different lighting time. If you wish to maximize battery life, you can de-activate the lighting function entirely.

There is also a lighting button [20], so that in any light situation, you can activate the backlighting feature. The lighting time in this case is set at the factory for a period of 2 seconds, which you can also change. If you wish to conserve battery power, you can de-activate the lighting function entirely.

### RC-5 Shipped destination:

As mentioned earlier in this guide, the RC-18SR is provided with many commands from the factory with infrared codes conforming to the Philips RC-5 remote control language (used by Marantz, Philips, and some other companies). We have provided two different RC-5 command code sets in the RC-18SR, due to the local requirements of different markets and the different types of remote control codes used in those markets. One code set is for North American (USA) users, while the other code set is for REST users. Your RC-18SR has been set at the factory for USA (United States) codes. It can be easily changed, if you wish.

### Set-Up:

To change the lighting time(s), or the destination setting, please follow these steps:

- Select the SETUP mode, by holding the **MEMO** button [13] and at the same time pressing the **OK** button within the cursor keys [16]. (see Figures 26 and 27)

Figure 26



Figure 27



### LAMP - Lighting function ON or OFF and TIME

Press the D-5 direct function button, and you can then set the time (in seconds) directly using the numeric key pad [12] buttons. A time figure consisting of only 1 digit can be input by pressing the figure then waiting for 2 seconds or input "0" before entering a desired digit. You can set time in the range from 0 up to 60 seconds (More time would use up more battery life than fewer seconds). "2" is set when shipped from the factory. To set "OFF" input "0".

### BEEP sound

The beep sounds when any buttons are pressed except the **AMP** button.

The beep sound level can be set by pressing the **D-6** button. The display indicates "+" indication and the beeps are sounded by pressing the **D-6** button. The "+" indication is followed, by another the "+" indication as the beep sound is increased; + → ++ → +++ → ++++

When the "++++" appears, this is the maximum. If the **D-6** button is pressed once more, it will reset to OFF.

"♪" is indicated in the LCD window when the beep sound is set.

### Note:

The beep sound is different between the function buttons and other buttons.

### VER

Press the **D-7** direct function button to switch between USA and REST.

If you need to change this function, we recommend that you make the change before you begin "learning" any new infrared codes for other brands of equipment in your system.

### Note:

The name of the **DIRECT** buttons will be erased if the USA/REST version is pressed.

### Battery life:

- Battery life will vary from user to user, if the remote is used constantly or only occasionally, including the amount of backlighting usage. We feel that you can expect the batteries to last about 4 months, based upon 15 remote control operations per day (every day), and 3 lighting operations per day (every day). If the remote is used more often, and if the lighting times are set to longer times than the factory settings, then the battery life may be shortened somewhat.
- As explained earlier in the guide, the RC-18SR's sophisticated battery conservation system will advise you long before the battery power is fully exhausted, and will further warn you to replace the batteries by simply becoming inoperative at a certain point. The customized memory contents and user-adjusted settings will still be retained in memory. When you install a fresh set of batteries, the memory contents are protected always, because the RC-18SR uses the non-volatile memory. Alkaline (and the newer lithium) types are recommended for longest battery life.

As you become more familiar over time with how you are using the RC-18SR in your A/V system, you may wish to consider reducing the lighting time(s) if possible, as this can help to extend the battery life.

### Adjustment of the LCD contrast

- The LCD contrast can be adjusted as follows;

Enter SETUP mode of the RC-18SR by pressing the MEMO and OK button. Press the VOL+ to increase the LCD contrast. Press the VOL - to decrease the LCD contrast. Press the OK buttons to end this setting and return the original operation.

## DIRECT COMMAND FUNCTIONS LISTING

Within the RC-18SR LCD window, each of the 8 Direct Function buttons has 4 character labels attached for pre-programmed remote commands. These commands can be used with various Marantz A/V components, or other components using the Philips RC-5 remote control language.

You can easily replace the factory-supplied remote command codes with different codes from other brands of equipment. Most functions that are supplied apply to a wide variety of equipment from many companies. The following list shows the remote code assignments for the direct function buttons, for each of the 11 main function selector buttons, as supplied from the factory. You can add or replace function commands, including re-naming them if you wish, in order to customize the RC-18SR for your own particular selection of A/V components.

AMP	1 MODE-1	1 AUTO 2 DOLB 3 THX 4 DTS 5 HALL 6 MTRX 7 MOV 8 2-CH	selects Auto select surround modes selects Dolby Digital or Pro Logic decoding selects THX cinema or THX Surround EX decoding selects DTS cinema or DTS music decoding Hall surround sound Matrix surround sound Movie surround sound Stereo sound (no surround)
	2 MODE-2	1 A/D 2 DIR 3 ATT 4 OSD 5 MONO ⊗ 6 3-D 7 NITE 8 MLTI	switches analog / digital input switches source direct switches attenuater for analog input switches on screen display monaural decoding 3-D surround decoding selects NIGHT mode for Dolby Digital activates multi-room mode
	3 MODE-3	1 TRB+ 2 TRB- 3 BAS+ 4 BAS- ⊗ 5 R-EQ 6 CH+ 7 LVL+ 8 LVL-	increases treble decreases treble increases bass decreases bass activates RE-EQ function next channel (up) increases channel level volume decreases channel level volume
	4 PROCESSOR ⊗	1 VOL+ ⊗ 2 VOL- 3 6-CH ⊗ 4 BYP 5 SLEP 6 DISP 7 MODE ⊗ 8 PHNO	increases external decoder's volume decreases external decoder's volume activates 6 channel setup bypasses external processor's decoding activates sleep timer function activates display off function selects surround mode selects phono function
TUNER	1 BAND	1 FM 2 AM ⊗ 3 LW 4 BAND 5 MODE ⊗ 6 TIME 7 F/P 8 SCAN	FM band AM/MW band long wave band selects radio band mono/stereo/muting mode selector time display frequency or preset channel display programmed preset channel scan

TUNER	2 REC	1 TP-1  2 REC 3 PAUS 4 STOP 5 TP-2  6 REC 7 PAUS 8 STOP	commands for Tape 1 control (NO output) record pause stop commands for Tape 2 control (NO output) record pause stop
	3 RDS (for REST only)	1 STM 2 AF 3 PTY 4 DISP 5 6 7 8 DWR	selects station mode selects AF function selects PTY function selects display function    selects DSR wave range
CD	1 MODE	1 CD+ 2 CD - ◆ 3 TEXT 4 RNDM 5 TRAY 6 TIME ◆ 7 RCL 8 AMS	CD changer next disc CD changer previous disc activates text function random (shuffle) play function tray open/close time display elapsed/remaining/total recall program memory automatic music scan
	2 CHANGER1	1 CD1 2 CD2 3 CD3 4 CD4 5 CD5 6 EDIT ◆ 7 REPT 8 CNCL	selects Disc 1 selects Disc 2 selects Disc 3 selects Disc 4 selects Disc 5 tape edit function repeat function cancel track programming
	3 CHANGER2	1 UNIT ◆ 2 DISC 3 TR 4 CATG 5 MODE 6 TITL 7 T-S 8 ENT	selects unit No. selects disc No. selects track No. selects category selects mode selects function title mode selects title search selects enter
	4 REC	1 TAPE 2 REC 3 PAUS 4 STOP 5 MD 6 REC 7 PAUS 8 STOP	commands for Tape control (no output) record pause stop commands for MD control (no output) record pause stop
TAPE	1 MODE	1 TP-A	selects tape deck A

The marked "⊗" keys are not used for SR-19EX.  
See page 30 to refer the marked "◆" keys.

TAPE	1 MODE	2 TP-B 3 DIR 4 TIME 5 TRAY 6 AMS 7 REC 8 PAUS	selects tape deck B auto-reverse direction time display tray open/close automatic music scan record pause
DVD	1 MODE1	1 ANGL 2 TITL 3 SUBT 4 MENU ◆ 5 OSD 6 AUD 7 SET 8 RTN	selects angle selects title menu selects subtitle selects main menu activates on screen display selects audio selects setup menu returns to menu
	2 MODE2	1 SLOW 2 LPLY 3 RNDM 4 RPT 5 A/B 6 +10 7 T/C 8 ZOOM	slow forward last play function shuffle play function repeat modes repeat A to B digit entry +10 title and chapter zoom mode on/off
	3 KARAOKE	1 ONOF 2 ONCE 3 MELO 4 VOCL 5 MODE 6 3-D 7 VSLF 8 VSLR	karaoke on/off once more play again melody play vocal support play karaoke modes surround processor on/off very slow forward very slow reverse
	4 REC	1 VCR1 2 REC 3 PAUS 4 STOP 5 MD 6 REC 7 PAUS 8 STOP	selects VCR1 control (no output) record pause stop selects MD control (no output) record pause stop
LD	1 MODE	1 SD-A 2 SD-B 3 DISP 4 AMS 5 RPTA 6 RPTB 7 CP/F 8 EDIT	side A side B display on/off automatic music scan Repeat A start point Repeat B stop point selects chapter or flame activates tape edit function
	2 LD	1 MSP+ 2 MSP- 3 FRM+ 4 FRM-	increases CAV multi-speed decreases CAV multi-speed frame advance frame reverse

LD	2 LD	5 MS-F 6 MS-R 7 AUD 8 D/CX	CAV multi-speed forward direction CAV multi-speed reverse direction Stereo, left only, right only channel digital audio, analog audio, CX NR
	3 REC	1 VCR1  2 REC 3 PAUS 4 STOP 5 VCR2  6 REC 7 PAUS 8 STOP	commands for VCR 1 control (NO output) record pause stop commands for VCR 2 control (NO output) record pause stop
	4 VCD (for REST only)	1 PBC 2 KARA 3 IDX+ 4 IDX- 5 SEL 6 RTN 7 NEXT 8 PREV	selects playback control selects karaoke index up index down play or select audio stop or select return next track previous track
TV	1 MODE (for USA only)	1 A/CH 2 100S 3 VID 4 INFO 5 VOL+ 6 VOL- 7 MUTE ◆ 8 OSD	alternate channel 100's video information increases TV volume decreases TV volume mute sound on/off activates on screen display
	2 MODE/MENU (for USA only)	1 S-PI 2 S-SO 3 S-CH 4 5 MENU 6 ADV 7 STAT 8	smart picture smart sound smart channel  menu advance status
	3 PIP1 (for USA only)	1 PIP 2 SWAP 3 FREZ 4 POSI 5 SIZE 6 STRO 7 PREV 8 RPLY	PIP on/off PIP swap PIP freeze PIP position PIP size PIP strobe PIP preview PIP instant replay
	4 PIP2/REC (for USA only)	1 CLR 2 SLOW 3 4 5 VCR1	PIP clear PIP slow motion

TV	4 PIP2/REC	6 REC 7 PAUS 8 STOP	record pause stop
TV	1 MODE (for REST only)	1 CH + 2 CH - 3 CH-C 4 VID 5 VOL+ 6 VOL- 7 MUTE 8 OSD	next channel (up) previous channel (down) channel call external (aux) video input increases TV volume decreases TV volume mute sound on/off on screen display on/off
	2 MENU/CBL (for REST only)	1 MENU 2 SLP 3 CBL + 4 CBL - 5 ADV 6 STAT 7 M-UP 8 M-DN	activates menu activates sleep timer cable tuning next channel cable tuning previous channel advances to next menu page shows current status Menu up (next) Menu down (previous)
	3 REC (for REST only)	1 VCR1 2 REC 3 PAUS 4 STOP 5 VCR2  6 REC 7 PAUS 8 STOP	commands for VCR 1 control record pause stop commands for VCR 2 control (NO output) record pause stop
	4 TV TXT (for REST only)	1 T/PG 2 HOLD 3 ENLG 4 RVL 5 CNCL 6 PG+ 7 PG- 8 ENT	switches time display activates page hold selects large of text page selects display of text page activates cancel picture increases page decreases page enters the next page
VCR1	1 MODE	1 CH+ 2 CH- 3 SLCT 4 AUD 5 OTR 6 REC 7 PAUS 8 STOP	next channel (up) previous channel (down) selects TV or VCR audio track selector one touch recording record pause stop
	2 PLAY MODE	1 2XPL 2 SLOW 3 STIL 4 5 SKIP 6 VIS+ 7 VIS-	twice normal playback speed slower than normal playback speed still frame  skip to next program marker VHS index search next VHS index search previous

VCR1	2 PLAY MODE	8	
	3 MENU	1 MENU 2 STAT 3 CLR 4 GOTO 5 PLUS 6 7 8	activates menu shows current status clear programming go to next item video PLUS
DSS	1 DSS	1 DISP 2 PREV 3 CH+ 4 CH- 5 FAV 6 ALT 7 FTCH 8 ANT	brings up on screen channel marker goes to previously selected channel next channel previous channel favorite users and channel lists alternate audio channel, languages brings up on screen channel logos selects broadcast or cable antenna
	2 MODE	1 CH+ 2 CH- 3 SLCT 4 AUD 5 OTR 6 REC 7 PAUS 8 STOP	next channel previous channel selects TV or VCR audio track selector one touch recording record pause stop
	3 PLAY MODE	1 2XPL 2 SLOW 3 STIL 4 5 SKIP 6 VIS+ 7 VIS- 8	two times play speed slow speed play still frame  skip to next program VHS index search next VHS index search previous
	4 MENU	1 MENU 2 STAT 3 CLR 4 GOTO 5 6 7 8	activate menu show current status clear programming go to next item
AUX	1 REC	1 VCR1  2 REC 3 PAUS 4 STOP 5 VCR2  6 REC 7 PAUS 8 STOP	commands for VCR 1 control (NO output) record pause stop commands for VCR 2 control (NO output) record pause stop

AUX	2 VCD/PHI 1 (for REST only)	1 CD+ 2 CD- 3 OSD 4 SCAN 5 A/B 6 SLOW 7 8	selects disc up selects disc down OSD on/off selects time search repeat A to B slow forward
	3 VCD/PHI 2 (for REST only)	1 PBC 2 KARA 3 IND+ 4 IND- 5 SEL 6 RTN 7 NEXT 8 PREV	selects playback control selects karaoke program selects video index up selects video index down selects in PBC returns in PBC next previous
	4 VCD/PHI 3 (for REST only)	1 CD+ 2 SHUT 3 OVEW 4 RESM 5 CHAN 6 FADR 7 8	selects disc up selects shutter function selects digest function selects last paly function selects channel selects MPX/vocal fader
MD (for REST only)	1 MODE 1	1 MD-A 2 MD-B 3 RPT 4 DISP 5 EJCT 6 AMS 7 RNDM 8 LP	selects MD A selects MD B selects repeat modes selects display modes eject automatic music scan randam display selects SP/LP mode
	2 EDIT	1 EDIT 2 CHAR 3 DEL 4 ENT 5 AMRK 6 SYNC 7 PROG 8	selects edit mode selects character mode selects delete selects enter selects auto marker syncro REC selects program mode
	3 REC	1 MD 2 RECP 3 PAUS 4 STOP 5 TAPE 6 REC 7 PAUS 8 STOP	command MD (no output) REC-pause pause stop command tape (no output) record pause stop
CD-R (for USA only)	1 REC	1 INPT 2 INCR 3 SYNC	selects input source increments track number activates SYNCRO. recording

CD-R	1 REC	4 REC 5 TRAY 6 DISP 7 FINL 8 BLNK	records pause opens/closes tray dispaly mode finalizes (writes TOC) records blank
	2 MODE	1 PROG 2 REPT 3 FTS 4 FAST 5 VOL+ 6 VOL- 7 IDX+ 8 IDX-	activates program mode activates repeat mode activates FTS mode searches FAST increases volume decreases volume increases index decreases index



## SURROUND MODES

The SR-19EX incorporates digital signal processors (DSP) which can reproduce various surround effects you experience in concert halls and movie theaters, etc. Nine Surround Modes, are provided to reproduce a variety of surround sound effects, according to the content of the source to be played.

<b>AUTO</b>	When this mode is selected, the receiver determines whether the digital input signal is Dolby Digital, PCM-audio or DTS. THX Surround EX will operate for any 5.1 channel source that has a Dolby Digital Surround EX auto trigger flag in the digital signal. <b>Note:</b> When a Dolby Digital or DTS signal is input, the number of channels for which the corresponding signal is encoded will be played. Inputting a Dolby Digital two channel signal with Dolby surround status automatically subjects that signal to Pro-Logic processing before play. PCM 96 KHz source material can be played in this mode.
<b>THX Cinema</b>	THX Cinema surround mode applies additional processing to Dolby Digital, DTS, and Dolby Pro Logic multi-channel surround sources. The THX processing was developed by Lucasfilm Ltd. to recreated the sound of top-quality theater. Use the THX Cinema mode for all movies on disc, tape or broadcast. In this mode, THX Surround EX will not operate. <b>Note:</b> PCM-audio signals can be subjected to THX processing when the sampling frequency is 32 kHz, 44.1 kHz or 48 kHz. However output will be muted when 96 kHz PCM signal is input.
<b>THX Surround EX</b>	In a movie theater, film soundtracks that have been encoded with Dolby Digital surround EX technology are able to reproduce an extra channel which has been added during the mixing of the program. This channel, called Surround Back, places sounds behind the listener in addition to the currently available front left, front center, front right, surround right, surround left and subwoofer channels. This additional channel provides the opportunity for more detailed imaging behind the listener and brings more depth, spacious ambience and sound localization than ever before. THX Surround EX will operate for any 5.1 channel source whenever THX is active. This mode is not available in the system without surround back speaker(s).
<b>DD (DOLBY Digital, DOLBY Pro Logic)</b>	This mode is used with source materials encoded in Dolby Digital and Dolby Surround. Dolby Pro Logic processing can be used on Dolby Surround encoded two channel source material (Dolby Digital two channels, PCM-audio and Analog stereo). This allows play of the four discrete channels (left, center, right and surround). <b>Note:</b> PCM-audio signals can be subjected to Pro Logic processing when the sampling frequency is 32 kHz, 44.1 kHz or 48 kHz. When a signal in another format is input, output will be muted.
<b>DTS Cinema DTS Music</b>	This mode is for DTS encoded source materials such as LASER DISC, CD, and DVD. In the DTS Music mode, the LFE signal is reduced by 10 dB. With DTS music material, you should select the DTS Music mode. When playing DTS movie discs select DTS cinema mode for proper reproduction of the LFE channel. The DTS mode cannot be used when an Analog input has been selected. When the signal in another digital format is input, output will be muted.
<b>DSP SURROUND (Hall,Matrix,Movie)</b>	These modes provide surround effect processing from each input source material. They will produce theater, concert hall and stadium like atmospheres. Select as your taste desires. <b>Note:</b> PCM-audio signals can be processed in this mode when sampling frequency is 32 kHz, 44.1 kHz or 48 kHz. The 96 kHz sampling frequency mutes output.
<b>5ch STEREO</b>	This mode is used to create a wider, deeper and more natural soundstage from two channel source material. This is done by feeding the left channel signal to both left front and left surround speaker and the right channel signal to both right front and right surround speaker. Additionally, the center and surround back channel reproduces a mix of the right and left channel.
<b>STEREO</b>	This mode bypasses all surround processing.
<b>MONO</b>	Stereo program sources (left and right channels) play normally when PCM-audio or analog stereo is input. With Dolby Digital and DTS sources, the 5.1 multi-channels are converted to two channel stereo. 96 KHz source material can be play back in stereo mode.
<b>Source Direct</b>	In the source direct mode, the tone control circuit and bass management configuration are bypassed for full range frequency response and the purist audio reproduction. 96 KHz source material can be play back in this mode. <b>Notes:</b> Internal speaker size is setup to front L/R = Large, Center = Large, Surround L/R = Large and Subwoofer = yes automatically. Tone controls are also defeated.

### Caution for DTS signal:

This signal can be played when the connected DVD-player, laser-disc player or CD-player is capable of DTS-digital output. For details, refer to the player's operation manual.

Depending on the player used, DTS play may produce noise. If that happens, set the Surround mode to DTS.

Playing a DTS-CD or DTS laser disc causes the player's analog output terminal to output noise. Before playing DTS sources, be sure to connect the player's digital output to SR-19EX's digital input. Be careful when connecting the output of these players to analog audio input.

Note that SR-19EX has the following restrictive functions built in to reduce noise emission as much as possible.

If DTS is selected while in the Surround mode, digital input cannot be switched to analog input. When the analog input function has been selected, Surround mode cannot be switched to DTS.

While signals from DTS-laser disc or CD are playing in another Surround mode, you cannot switch to digital input or from digital input to analog input.

### Caution for 96kHz PCM-audio signal:

This signal can be played when a DVD-player or DAT-player connected to SR-19EX is capable of 96 kHz PCM output. For details, refer to the player's operation manual.

The signal can be played when STEREO or AUTO has been selected for the Surround mode.

Some DVD formatted discs featured copy protect. When using such disc, 96 kHz PCM signal is not output from the DVD player. For details, refer to the player's operation manual.

### The relation between the selected surround mode and the input signal

The surround mode is selected with the surround mode buttons on SR-19EX or the remote control unit. However, the sound you hear is subject to the relationship between the selected surround mode and input signal. That relationship is as follows;

Surround mode	Input signal	Output					FTD Indicator		
		L/R	SL/SR	SbL/SbR	C	SW	Encoded status	Surround Mode	CH status
AUTO	AC-3(5.1ch)	○	○	-	○	○	☐☐ DIGITAL	AUTO : DOLBY D	L,C,R,SL,SR,LFE
	AC-3(2ch)	○	-	-	-	-	☐☐ DIGITAL	AUTO : STEREO	L,R
	AC-3(2ch: Lt/Rt)	○	○	-	○	○	☐☐ DIGITAL, ☐☐ SURROUND	AUTO : PRO LOGIC	L,R,S
	AC-3 (EX)	○	○	○	○	○	☐☐ DIGITAL	AUTO : THX Sur EX	L,C,R,SL,S,SR,LFE
	96kHz PCM	○	-	-	-	○	PCM	AUTO : STEREO 96k	L,R
	PCM(audio)	○	-	-	-	○	PCM	AUTO : STEREO	L,R
	Analog	○	-	-	-	○	ANALOG	AUTO : STEREO	-
DTS(5.1ch)	○	○	-	○	○	dtc	AUTO : DTS Cinema	L,C,R,SL,SR,LFE	
S-Direct	AC-3(5.1ch)	○	○	-	○	○	☐☐ DIGITAL	SOURCE DIRECT	L,C,R,SL,SR,LFE
	AC-3(2ch)	○	-	-	-	-	☐☐ DIGITAL	SOURCE DIRECT	L,R
	AC-3(2ch: Lt/Rt)	○	○	-	○	-	☐☐ DIGITAL, ☐☐ SURROUND	SOURCE DIRECT	L,R,S
	AC-3 (EX)	○	○	-	○	○	☐☐ DIGITAL	SOURCE DIRECT	L,C,R,SL,S,SR,LFE
	96kHz PCM	○	-	-	-	-	PCM	S-DIRECT 96k	L,R
	PCM(audio)	○	-	-	-	-	PCM	SOURCE DIRECT	L,R
	Analog	○	-	-	-	-	ANALOG	SOURCE DIRECT	-
DTS(5.1ch)	○	○	-	○	○	dtc	SOURCE DIRECT	L,C,R,SL,SR,LFE	
THX	AC-3(5.1ch)	○	○	-	○	○	☐☐ DIGITAL	THX 5.1	L,C,R,SL,SR,LFE
	AC-3(2ch)	○	○	-	○	○	☐☐ DIGITAL	THX 4.0	L,R
	AC-3(2ch: Lt/Rt)	○	○	-	○	○	☐☐ DIGITAL, ☐☐ SURROUND	THX 4.0	L,R,S
	AC-3 (EX)	○	○	-	○	○	☐☐ DIGITAL	THX 5.1	L,C,R,SL,S,SR,LFE
	96kHz PCM	-	-	-	-	-	(PCM)	THX 4.0 (96kHz)	L,R
	PCM(audio)	○	○	-	○	○	PCM	THX 4.0	L,R
	Analog	○	○	-	○	○	ANALOG	THX 4.0	-
DTS(5.1ch)	○	○	-	○	○	dtc	THX 5.1	L,C,R,SL,SR,LFE	
THX EX	AC-3(5.1ch)	○	○	○	○	○	☐☐ DIGITAL	THX Sur EX	L,C,R,SL,SR,LFE
	AC-3(2ch)	○	○	-	○	○	☐☐ DIGITAL	THX 4.0	L,R
	AC-3(2ch: Lt/Rt)	○	○	-	○	○	☐☐ DIGITAL, ☐☐ SURROUND	THX 4.0	L,R,S
	AC-3 (EX)	○	○	○	○	○	☐☐ DIGITAL	THX Sur EX	L,C,R,SL,S,SR,LFE
	96kHz PCM	-	-	-	-	-	(PCM)	THX 4.0 (96kHz)	L,R
	PCM(audio)	○	○	-	○	○	PCM	THX 4.0	L,R
	Analog	○	○	-	○	○	ANALOG	THX 4.0	-
DTS(5.1ch)	○	○	○	○	○	dtc	THX Sur EX	L,C,R,SL,SR,LFE	
☐☐	AC-3(5.1ch)	○	○	-	○	○	☐☐ DIGITAL	DOLBY D	L,C,R,SL,SR,LFE
	AC-3(2ch)	○	○	-	○	○	☐☐ DIGITAL	DOLBY Pro Logic	L,R
	AC-3(2ch: Lt/Rt)	○	○	-	○	○	☐☐ DIGITAL, ☐☐ SURROUND	DOLBY Pro Logic	L,R,S
	AC-3 (EX)	○	○	○	○	○	☐☐ DIGITAL	DOLBY D EX	L,C,R,SL,S,SR,LFE
	96kHz PCM	-	-	-	-	-	(PCM)	DOLBY D (96kHz)	L,R
	PCM(audio)	○	○	-	○	○	PCM	DOLBY Pro Logic	L,R
	Analog	○	○	-	○	○	ANALOG	DOLBY Pro Logic	-
DTS(5.1ch)	-	-	-	-	-	(dtc)	DOLBY D	-	
DTS Cinema	AC-3(5.1ch)	-	-	-	-	-	(☐☐ DIGITAL)	DTS Cinema (no data)	-
	AC-3(2ch)	-	-	-	-	-	(☐☐ DIGITAL)	DTS Cinema (no data)	-
	AC-3(2ch: Lt/Rt)	-	-	-	-	-	(☐☐ DIGITAL)	DTS Cinema (no data)	-
	AC-3 (EX)	-	-	-	-	-	(☐☐ DIGITAL)	DTS Cinema (no data)	-
	96kHz PCM	-	-	-	-	-	(PCM)	DTS Cinema (96kHz)	-
	PCM(audio)	-	-	-	-	-	(PCM)	DTS Cinema (no data)	-
	Analog	-	-	-	-	-	ANALOG	-	-
DTS(5.1ch)	○	○	-	○	○	dtc	DTS Cinema	L,C,R,SL,SR,LFE	
DTS music	AC-3(5.1ch)	-	-	-	-	-	(☐☐ DIGITAL)	DTS Music (no data)	-
	AC-3(2ch)	-	-	-	-	-	(☐☐ DIGITAL)	DTS Music (no data)	-
	AC-3(2ch: Lt/Rt)	-	-	-	-	-	(☐☐ DIGITAL)	DTS Music (no data)	-
	AC-3 (EX)	-	-	-	-	-	(☐☐ DIGITAL)	DTS Music (no data)	-
	96kHz PCM	-	-	-	-	-	(PCM)	DTS Music (96kHz)	-
	PCM(audio)	-	-	-	-	-	(PCM)	DTS Music (no data)	-
	PCM(HDCD)	-	-	-	-	-	(PCM)	DTS Music (no data)	-
Analog	-	-	-	-	-	ANALOG	-	-	
DTS(5.1ch)	○	○	-	○	○	dtc	DTS Music	L,C,R,SL,SR,LFE	
DSP (Hall,Matrix Movie,etc)	AC-3(5.1ch)	○	○	-	○	○	☐☐ DIGITAL	Movie or Hall or Matrix	L,C,R,SL,SR,LFE
	AC-3(2ch)	○	○	-	○	○	☐☐ DIGITAL	Movie or Hall or Matrix	L,R
	AC-3(2ch: Lt/Rt)	○	○	-	○	○	☐☐ DIGITAL, ☐☐ SURROUND	Movie or Hall or Matrix	L,R,S
	AC-3 (EX)	○	○	-	○	○	☐☐ DIGITAL	Movie or Hall or Matrix	L,C,R,SL,S,SR,LFE
	96kHz PCM	-	-	-	-	-	(PCM)	Movie or Hall or Matrix (96kHz)	-
	PCM(audio)	○	○	-	○	○	PCM	Movie or Hall or Matrix,	L,R
	Analog	○	○	-	○	○	ANALOG	Movie or Hall or Matrix	-
DTS(5.1ch)	○	○	-	○	○	dtc	Movie or Hall or Matrix,	L,C,R,SL,SR,LFE	
DTS(ES)	○	○	-	○	○	dtc	Movie or Hall or Matrix,	L,C,R,SL,S,SR,LFE	

Surround mode	Input signal	Output					FTD Indicator		
		L/R	SL/SR	SbL/SbR	C	SW	Encoded status	Surround Mode	CH status
5ch Stereo	AC-3(5.1ch)	○	○	-	○	○	□□ DIGITAL	5ch STEREO	L,C,R,SL,SR,LFE
	AC-3(2ch)	○	○	○	○	○	□□ DIGITAL	5ch STEREO	L,R
	AC-3(2ch: Lt/Rt)	○	○	○	○	○	□□ DIGITAL, □□ SURROUND	5ch STEREO	L,R,S
	AC-3 (EX)	○	○	-	○	○	□□ DIGITAL	5ch STEREO	L,C,R,SL,S,SR,LFE
	96kHz PCM	-	-	-	-	-	PCM	5ch STEREO (96k)	-
	PCM(audio)	○	○	○	○	○	PCM	5ch STEREO	L,R
	Analog	○	○	○	○	○	ANALOG	5ch STEREO	-
STEREO	DTS(5.1ch)	○	○	-	○	○	dtc	5ch STEREO	L,C,R,SL,SR,LFE
	AC-3(5.1ch)	○	-	-	-	○	□□ DIGITAL	STEREO	L,C,R,SL,SR,LFE
	AC-3(2ch)	○	-	-	-	○	□□ DIGITAL	STEREO	L,R
	AC-3(2ch: Lt/Rt)	○	-	-	-	○	□□ DIGITAL, □□ SURROUND	STEREO	L,R,S
	AC-3 (EX)	○	-	-	-	○	□□ DIGITAL	STEREO	L,C,R,SL,S,SR,LFE
	96kHz PCM	○	-	-	-	○	PCM	STEREO 96k	L,R
	PCM(audio)	○	-	-	-	○	PCM	STEREO	L,R
MONO	Analog	○	-	-	-	○	ANALOG	STEREO	-
	DTS(5.1ch)	○	-	-	-	○	dtc	STEREO	L,C,R,SL,SR,LFE
	AC-3(5.1ch)	-	-	-	○	○	□□ DIGITAL	MONO	L,C,R,SL,SR,LFE
	AC-3(2ch)	-	-	-	○	○	□□ DIGITAL	MONO	L,R
	AC-3(2ch: Lt/Rt)	-	-	-	○	○	□□ DIGITAL, □□ SURROUND	MONO	L,R,S
	AC-3 (EX)	-	-	-	○	○	□□ DIGITAL	MONO	L,C,R,SL,S,SR,LFE
	96kHz PCM	-	-	-	-	-	(PCM)	MONO (96k)	-
6ch Input	PCM(audio)	-	-	-	○	○	PCM	MONO	L,R
	Analog	-	-	-	○	○	ANALOG	MONO	-
	DTS(5.1ch)	-	-	-	○	○	dtc	MONO	L,C,R,SL,SR,LFE

**Note:** AC-3(2ch:Lt/Rt)signals have Dolby Surround flag.  
SPKRS setup is full THX system (8ch Speakers).

L/R : Front speaker  
 SL/SR : Surround speaker  
 SbL/SbR : Surround back speaker  
 C : Center speaker  
 SW : Sub woofer speaker  
 ( ): The indicator blinks

# TROUBLESHOOTING

## In case of trouble, check the following before calling for service:

1. Are the connections made properly ?
2. Are you operating the unit properly following user's guide ?
3. Are the power amplifiers and speaker working properly ?

If the unit does not operate properly, check items shown in the following table.

If your trouble cannot be recovered with the remedy actions listed in the following table, malfunction of the internal circuitry is suspected; immediately unplug the power cable and contact your dealer, nearest Marantz distributor or the Marantz Service Center in your country.

SYMPTOM	CAUSE	REMEDY
SR-19EX cannot be turned up.	The power plug is not connected.	Connect the power plug to the outlet.
No sound and picture are output even when power is on.	Mute is on. The input cable is not connected correctly. The master volume control is turned all the way down. The function selector position is wrong.	Cancel mute using the remote control unit. See the connection diagram and connect the cables correctly. Adjust the master volume. Select correct position.
Speaker not outputting any sound.	The headphones are connected to the headphone jack.	Disconnect the headphones. (Speakers will not output sound when headphones are connected.)
Sound and pictures from other than equipment selected with the function selector.	Input cable connected incorrectly.	Connect the cable correctly by referring to the connection diagram.
Sound from the wrong channel is output from the speaker.	Speaker cable connected incorrectly.	Connect the cable correctly by referring to the connection diagram.
No sound is output from the center speaker.	The center speaker cable connection is incomplete. STEREO has been selected for Surround mode.  Center = NONE has been selected in SETUP mode.	Connect the cable correctly. When STEREO is selected for Surround mode, no sound will be output from the center speaker. Set another Surround mode. Make the correct setting.
No sound is output from the surround speaker.	The surround speaker cable connection is incomplete. STEREO has been selected for Surround mode.  Surround = NONE has been selected in SETUP mode.	Connect the cable correctly. When STEREO has been selected for Surround mode, no sound will be output from the surround speaker. Set another Surround mode. Make the correct setting.
No output to Sub Woofer Out.	Sub-woofer = NONE has been selected in SETUP mode.	Select Sub-woofer = YES.
Surround mode cannot be changed.	The headphones are connected to the jack.	Disconnect the headphones. (When headphones are connected, Surround mode will be fixed to STEREO.)
Noise is produced during DTS-encoded CD or laser disc play.	Analog has been selected for input.	Be sure to perform digital connection, select digital input, then play.
DTS sources cannot be played.	Surround mode is set to DOLBY. The DVD or LD player is not DTS digital out capable.	Select other mode. Use a player which responds to DTS-digital out.
Player skips during play of a DTS source and produces noise.	Data error occurred during player skip.	Set Surround mode to DTS-cinema or DTS-music..
A 96kHz PCM signal cannot be played.	The disc player is not 96kHz PCM digital out capable. Surround mode is set to other than STEREO and AUTO.	Use a player that responds to 96kHz PCM digital out. Set Surround mode to STEREO or AUTO.
A normal PCM signal (CD or laser disc) cannot be played.	Surround mode is set to DTS-cinema or DTS-music.	Select other mode.
A Dolby Digital signal cannot be played.	Surround mode is set to DTS-cinema or DTS-music.	Select other mode.
A specific channel does not produce output.	Nothing recorded on source.	Check the encoded channel on the source side.
FM or AM reception fails.	Antenna connection is incomplete.	Correctly connect the indoor FM and AM antennas to FM and AM antenna outlets.
Noise is heard during AM reception.	Reception is affected by other electrical fields.	Try changing location where the AM indoor antenna is set up.
Noise is heard during FM reception.	The radio waves from the broadcasting station are weak.	Install an FM outdoor antenna or use cable TV/FM.
Cannot get programmed station when the PRESET button is pressed.	Preset data has been erased.	Disconnecting power plug for long periods of time will erase preset data. If that happens, input the preset data again.
Nothing appears on the remote commander display.	Batteries are consumed.	Replace all the batteries with new ones.
Control with the remote control unit fails.	Batteries are consumed.. Remote controller's function-key setting is wrong. The distance between this SR-19EX and the remote commander is too far. Something is blocking SR-19EX and the remote commander.	Replace all the batteries with new ones.. Select different position from which equipment will be controlled. Move closer to this SR-19EX.  Remove offending object.
No sound is output from the surround back speaker.	The surround speaker cable connection is incomplete. STEREO has been selected for Surround mode. Surr. Back = NONE has been selected in SETUP mode. surround back speaker. Surround mode is not THX surround EX.	Connect the cable correctly. Surround back channel is active in THX surround EX mode, in other Surround mode, no sound will be output from the surround speaker. Set THX Surround EX mode.

## GENERAL MALFUNCTION

If the equipment malfunctions, this may be because an electrostatic discharge or AC line interference has corrupted the information in the equipment memory circuits. Therefore:

- disconnect the plug from the AC line supply
- after waiting at least three minutes, reconnect the plug to the AC line supply
- re-attempt to operate the equipment

## ERROR MESSAGES

When the display indicates some error messages (e.g. ERROR \*\*), unplug the power cable immediately. Contact your dealer, nearest Marantz distributor or the Marantz service center in your area.

### Memory backup

- In case a power outage occurs or the power cord is accidentally unplugged, the SR-19EX is equipped with a backup function to prevent memory data such as the preset memory from being erased. The memory functions are backed up for up to about one week.

### NOTE:

First of all keep SR-19EX Standby or Powered-on more than six hours, to sufficient time for memory back up.

## HOW TO RESET THE UNIT

Should the operation or display seem to be abnormal, reset the unit with the following procedure.

The SR-19EX is turned on, press and hold the **CL** (CLEAR) ⑨ and **DISPLAY OFF** ⑩ buttons simultaneously for 3 seconds or more.

Remember that the procedure will reset the settings of the function selector, Surround mode, delay time, TUNER PRESET etc., to their initial settings.

# TECHNICAL SPECIFICATIONS

## FM TUNER SECTION

Frequency Range .....	87.5 - 108.0 MHz
Usable Sensitivity .....	IHF 1.8 $\mu$ V/16.4 dBf
Signal to Noise Ratio .....	Mono/Stereo 76/72 dB
Distortion .....	Mono/Stereo 0.2/0.3 %
Stereo Separation .....	1 kHz 45 dB
Alternate Channel Selectivity .....	$\pm$ 400 kHz 60 dB
Image Rejection .....	98 MHz 70 dB
Tuner Output Level .....	1 kHz, $\pm$ 75 kHz Dev 800 mV

## AM TUNER SECTION

Frequency Range .....	520 - 1710 kHz
Signal to Noise Ratio .....	50 dB
Usable Sensitivity .....	Loop 400 $\mu$ V
Distortion .....	1 kHz, 30 % Mod. 0.5 %
Selectivity .....	$\pm$ 20 kHz 70 dB

## AUDIO SECTION

Power Output	
FRONT (20 Hz - 20 kHz) .....	8 ohms 130 W / Ch
Center (20 Hz - 20 kHz) .....	8 ohms 130 W / Ch
Surround (20 Hz - 20 kHz) .....	8 ohms 130 W / Ch
THD Front (20 Hz - 20 kHz) .....	8 ohms 0.05 %
Input Sensitivity/Impedance	
Linear .....	350 mV/ 47 Kohms
Signal to Noise Ratio	
Linear .....	106 dB
Frequency Response (Analog Input / Source Direct) .....	8 Hz - 80 kHz ( $\pm$ 3 dB)
(Digital Input / 96 kHz PCM) .....	8 Hz - 45 kHz ( $\pm$ 3 dB)

## VIDEO

Television Format .....	NTSC
Input Level/Impedance .....	1 Vp-p/75 ohms
Output Level/Impedance .....	1 Vp-p/75 ohms
Video Frequency Response .....	5 Hz to 8 MHz ( $-$ 1 dB)
S/N .....	60 dB

## GENERAL

Power Requirement .....	AC 120 V 60 Hz
Power Consumption (STEREO MODE RATED POWER) .....	530 W
Dimension (MAX)	
Width .....	18 inches (458 mm)
Height .....	7-1/2 inches (190 mm)
Depth .....	19-1/2 inches (496 mm)
Weight .....	53.9 lbs (24.5 Kg)

## ACCESSORIES

Remote Control Unit RC-18SR .....	1
AA-size batteries .....	4
FM Feeder Antenna .....	1
AM Loop Antenna .....	1

Specifications subject to change without prior notice.

COUNTRY	COMPANY	ADDRESS
ALGERIE	Azur 2000	8, Lotissement Ben Hatadi, Alger, Algeria
ARMENIA	NGYIG Ltd.	47 A/75 St. Lalaiaants, 375000 Yerevan, Armenia
AUSTRALIA	Jamo Australia Pty. Ltd.,	24 Lionel Road, Mt. Waverley, VIC 3149, Australia
AUSTRIA	Huber & Prohaska GmbH	Taborstraße 95 / Ladestraße 1, Gebäude Hangartner, A-1200 Wien, Austria
BAHREIN	Ambassador Stores	P.O. Box 237,141, Government Avenue, Manama,Bahrein
BANGLADESH	Target	1078, Ramjoy Mohanja Lane Asadonj, Chittagong 4000, Bangladesh
BELGIUM	Van der Heyden Audio N.V.	Brusselbaan 278, 9320 Eredebodegem, Belgium
BULGARIA	Ariescommerce GmbH	Makedonia Blvd. 16, 1606 Sofia, Bulgaria
CANADA	Lenbrook Industries Limited	633 Granite Court, Pickering, Ontario
CHINA	Guang Chang Audio International Co., Ltd.	No.38 Yushan Road, ShiQiao, Pan Yu, Guang Dong, China
CYPRUS	Empire Hifi systems Ltd.	P.O. Box 5604, Nicosia, Cyprus
CZECH REPUBLIC	Audio International	Sokolska 41, 67902 Rajecsko, OKR,Blansko, Czech Republic
DENMARK	Audio Nord	Dali Allé 1, 9610 Noerager, Denmark
DUBAI	V.V.& SONS	P.O. Box 105, Dubai, U.A.E.
EGYPT	Solimco	9, El Attibaa St. Doki, Cairo, Egypt
ESTONIA	HiFi Club Estonia	Ehte 4, 90503 Haapsalu, Estonia
F.Y.R.O.M.	T.P. KODI	ul.Cedomir Kantargiev 21a, Skopje, Former Yugoslavian Republic of Macedonia
FINLAND	Audio Nord	Uudenmaankatu 4-6, Helsinki SF-00120, Finland
FRANCE	Marantz France	A division of Marantz Europe B.V., P.O. Box 301, 92 156 Suresnes Cedex, France
GERMANY	Marantz Deutschland	Hakenbusch 3, 49078 Osnabrück, Germany
GREECE	Adamco S.A.	188, Hippocratous Street, 11471 Athens, Greece
HEADQUARTERS EUROPE:	Marantz Europe B.V.	Building SFF-2, P.O. Box 80002, 5600 JB Eindhoven, The Netherlands
HONG KONG	Marantz Asia Ltd.	Unit 1706, Metroplaza II, 223 Hing Fong Road, Kwai Fong, N.T., Kowloon, Hong Kong
HUNGARY	Infovox Ltd.	Terez Krt.31, 1067 Budapest, Hungary
ICELAND	ID Electronics Ltd.	Armula 38, 108 Reykjavik, Iceland
INDIA	NOVA Audio Private	8,Punam Co-op.Society 29/30 Road#5, Union Park MUMBAI 400052, India
IRAN	Home Co.	5th floor no 878 Philips Building Enghelab ave, P.O. 11365/7844 Tehran, Iran
IRELAND	Marantz Ireland	Clonskeagh, Dublin 14, Ireland
ISRAEL	Elmor Ltd.	52 Heh Beiyar Street, Kikar Hamedina, Tel Aviv, Israel
ITALY	Marantz Italy	Via Casati 23, 20052 Monza (Milano), Italy, Servizio Consumatori 1678-20026, Numero Verde
IVORY COAST	Hifivoir	B.P. 2428, Abidjan 01, Ivory Coast
JAPAN	Marantz Japan Inc.	35-1 Sagami Ohno 7-Chome, Sagamihara-shi, Kanagawa 228-8505, Japan
KOREA	Mk Enterprises Ltd.	121-210, 2F Shinhan Bldg., 247-17 Seokyo-dong, Mapo-ku, Seoul, Korea
KUWAIT	alAlamiah Electronics Intl.	P.O. Box 8196, Salmiah 22052, Kuwait
LATVIA	Ace Ltd.	61, LacPlesa Str., Riga LV 1011, Latvia
LEBANON	AZ Electronics S.A., 1,	P.O. Box 11 2833, Beirut, Lebanon
LITHUANIA	Accapella Ltd.	Ausros, Vartu G/5, Pasazo SKG., 2001 Vilnius, Lithuania
MALAYSIA	Wo Kee Hong Electronics Sdn. Bhd.	102 Jalan SS 21/35, Damansara Utama, 47400 Petaling Jaya, Selangordarul Ehsan, Malaysia
MALTA	Doneo Co Ltd.	78 The Strand, Sliema SLM07, Malta
MAURITIUS	SKR Electronics Ltd.	P.O. Box 685, Bell Village, Port Louis, Mauritius
MILITARY MARKET EUROPE	PASCO GmbH	PO BOX 1280, Sandhausen 69200, Germany
NETHERLANDS	Marantz Domestic Sales	A division of Marantz Europe B.V., Building SFF2, P.O. Box 80002, 5600 JB Eindhoven, The Netherlands
NEW ZEALAND	Wildash Audio Systems	14 Malvern Road, Mt. Albert, Auckland, New Zealand
NORWAY	Audio Nord	Sandkerveien 64, Oslo 0483, Norway
OMAN	Mustafa & Jawad Trading CO.	P.O. Box 1918, Ruwi, Oman
POLAND	Philips Polska Sp. z.o.o.	Al.Jerozolimskie 195b, 02 222 Warszawa, Poland
PORTUGAL	Corel2	Comércio de Electrónica Lda., Av. Luís Bivar, No 85 A, 1050 Lisboa, Portugal
PROFESSIONAL EUROPE	Marantz Professional Products	Kingsbridge House, Padbury Oaks, 575-583 Bath Road, Longford, Middlesex UB7 0EH, U.K.
PROFESSIONAL U.S.A.	Marantz Professional Products	Distributed by: Superscope Technologies Inc., 1000 Corporate Blvd. Ste.D, Aurora, Illino
QATAR	Almana & Partners W.W.L.	P.O. Box 49, Doha, Qatar
REUNION	Vision +	180 Rue du Marechal Leclerc, 97400 Saint Denis, Ile de la Reunion
ROMANIA	Nova Music Entertainment	5, Zagazului Str. Bl.1G,apt.18, sector 1,Bucharest, Romania
RUSSIA	Absolute Audio	7/2, Montazhnaya Street, 107497 Moscow, Russia
SAUDI ARABIA	Adawlia Univ. Electr. Apl	P.O. Box 2154, Alkhobar 31952, Saudi Arabia
SINGAPORE	Forward Marketing (S) Pte. Ltd.	Wo Kee Hong Centre, 29 Leng Kee Road, Singapore 159099, Singapore
SLOVAKIA	Bis Audio s.r.o.	Nam. SNP 10, 96001 Zvolem, Slovakia
SLOVENIA	Bofex	Smartinska 152, HALA V/3, 61000 Ljubljana, Slovenia
SOUTH AFRICA	Coherent Imports (PTY) Ltd.	P.O. Box 1614, Alberton, 1450, South Africa
SPAIN	Marantz Spain	Martinez Villergas 2, Apartado 2065, Madrid 28027, Spain
SRI LANKA	The listening Room	Mezzanine Floor, The Landmark 385, Galle Road, Colombo - 3, Sri Lanka
SWEDEN	Audio Nord	Almedalsvagen 4, Gotenborg 402-23, Sweden
SWITZERLAND	Sound Company AG	Postfach, 8010 Zürich, Switzerland
SYRIA	Hamzeh & Partners	Hafez Ibrahim Str. No 117, Damascus Shalan, Syria
TAHITI	Covecolor	Av. Prince Hinoi, Cours de l'union sacré, P.O. Box 2334, Papeete, Tahiti
TAIWAN	Pai-Yuing Co. Ltd.	6th No 148 Sung Kiang Road, Taipei 10429, Taiwan R.O.C.
THAILAND	MRZ Standard Co. Ltd.	746-750 Mahachai Road, Wangburapa, Bangkok 10200, Thailand
TUNESIA	Societe EDEVIG	40, Avenue du Golfe Arabe, El Menzah, 1004, Tunesia
TURKEY	Türk Philips Ticaret A.S.	Yukari Dudullu Organize sanayi Bolgesi, 2.Cadde no.28, 81260 Umraniye-Istanbul, Turkey
U.K.	Marantz Hifi UK Ltd.	Kingsbridge House, Padbury Oaks, 575-583 Bath Road, Longford, Middlesex UB7 0EH, U.K.
U.S.A.	Marantz America Inc.	440 Medinah Road, Roselle, IL 60172, U.S.A.
YUGOSLAVIA	ITM Company	Omladinskih Brigada 86, 11070 Belgrade, Yugoslavia
EXPORT	Marantz Domestic Sales	A division of Marantz Europe BV,Building SFF2, P.O. Box 80002, 5600 JB Eindhoven, TheThe Netherlands

[www.marantz.com](http://www.marantz.com)

Manufactured under license from Dolby Laboratories. "Dolby", "AC-3", "Pro Logic" and the double-D symbol are trademarks of Dolby Laboratories. Confidential Unpublished Works. © 1992-1997 Dolby Laboratories, Inc. All rights reserved.

Manufactured under license from Digital Theater Systems, Inc. US Pat. No. 5,451,942 and other worldwide patents issues and pending. "DTS" and "DTS Digital Surround" are trademarks of Digital Theater Systems, Inc. © 1996 Digital Theater Systems, Inc. All rights reserved.

"Lucasfilm®" and "THX®" are registered trademarks of Lucasfilm Ltd. "SURROUND EX™" is a trademark of Dolby Laboratories. Used under authorization.

HDCD® , HDCD®, High Definition Compatible Digital® and Pacific Microsonics™ are either registered trademarks or trademarks of Pacific Microsonics, Inc. in the United States and/or other countries.

HDCD system manufactured under license from Pacific Microsonics, Inc. This product is covered by one or more of the following: In the USA: 5,479,168, 5,638,074, 5,640,161, 5,808,574, 5,838,274, 5,854,600, 5,864,311, 5,872,531, and in Australia: 669114. Other patents pending.

## Free Manuals Download Website

<http://myh66.com>

<http://usermanuals.us>

<http://www.somanuals.com>

<http://www.4manuals.cc>

<http://www.manual-lib.com>

<http://www.404manual.com>

<http://www.luxmanual.com>

<http://aubethermostatmanual.com>

Golf course search by state

<http://golfingnear.com>

Email search by domain

<http://emailbydomain.com>

Auto manuals search

<http://auto.somanuals.com>

TV manuals search

<http://tv.somanuals.com>