



D4-470 User Manual

Manual Number D4-470-M

Read This First

Read This Manual Before Making Changes To The D4-470





WARNING

Thank you for purchasing automation equipment from **Automationdirect.com**[™]. We want your new **DirectLOGIC**[™] automation equipment to operate safely. Anyone who installs or uses this equipment should read this publication (and any other relevant publications) before installing or operating the equipment.

To minimize the risk of potential safety problems, you should follow all applicable local and national codes that regulate the installation and operation of your equipment. These codes vary from area to area and usually change with time. It is your responsibility to determine which codes should be followed, and to verify that the equipment, installation, and operation is in compliance with the latest revision of these codes.

At a minimum, you should follow all applicable sections of the National Fire Code, National Electrical Code, and the codes of the National Electrical Manufacturer's Association (NEMA). There may be local regulatory or government offices that can also help determine which codes and standards are necessary for safe installation and operation.

Equipment damage or serious injury to personnel can result from the failure to follow all applicable codes and standards. We do not guarantee the products described in this publication are suitable for your particular application, nor do we assume any responsibility for your product design, installation, or operation.

If you have any questions concerning the installation or operation of this equipment, or if you need additional information, please call us at 770-844-4200.

This publication is based on information that was available at the time it was printed. At **Automationdirect.com**[™] we constantly strive to improve our products and services, so we reserve the right to make changes to the products and/or publications at any time without notice and without any obligation. This publication may also discuss features that may not be available in certain revisions of the product.



Trademarks

This publication may contain references to products produced and/or offered by other companies. The product and company names may be trademarked and are the sole property of their respective owners. **Automationdirect.com**[™] disclaims any proprietary interest in the marks and names of others.

Copyright 2000, Automationdirect.com[™] Incorporated
All Rights Reserved

No part of this manual shall be copied, reproduced, or transmitted in any way without the prior, written consent of **Automationdirect.com**[™] Incorporated. **Automationdirect.com**[™] retains the exclusive rights to all information included in this document.

Table of Contents

Chapter 1: Introduction to the D4–470

Manual Overview	1–2
Purpose of this Manual	1–2
Other Reference Materials	1–2
Who Should Read This Manual	1–2
Technical Support	1–2
Key Topics for Each Chapter	1–3
Chapters	1–3
D4–470 Overview	1–4
Compact Size	1–4
Pentium Processor	1–4
High-Speed I/O Connection	1–4
Configuration Choices	1–5
Accessories	1–6

Chapter 2: Installation, Wiring, and Specifications

Mounting and Wiring Guidelines	2–2
Panel Layout & Clearances	2–2
Enclosures	2–3
Agency Approvals	2–3
Power Wiring	2–4
Internal Power Supply	2–4
Power Supply Limitations	2–4
Ports and Connectors	2–5
Left Side	2–5
Right Side	2–6
Technical and Environmental Specifications	2–7
Dimensions	2–10

Chapter 3: Installing Hardware Accessories

Adding Third-Party Boards to Expansion Slots	3–2
Four ISA and PCI Expansion Slots	3–2
Knock-out Panels	3–3
Installing Additional RAM Memory	3–4
Installing the Memory	3–4
Powering Internal and External Devices	3–5
Changing the CPU	3–5

Appendix A: European Union Directives (CE)

European Union (EU) Directives	A-2
Member Countries	A-2
Special Installation Manual	A-3
Other Sources of Information	A-4
Basic EMC Installation Guidelines	A-4
Enclosures	A-4
Suppression and Fusing	A-5
Internal Enclosure Grounding	A-5
Equi-potential Grounding	A-6
Communications and Shielded Cables	A-6
Analog and RS232 Cables	A-7
Multidrop Cables	A-7
Shielded Cables	A-7
within Enclosures	A-7
Network Isolation	A-7
Items Specific to the D4-470	A-8
Maintenance of the D4-470	A-8

Manual Revisions

If you contact us in reference to this manual, be sure to include the revision number.

Title: D4-470 User Manual

Manual Number: D4-470-M

Edition/Rev	Date	Description of Changes
Original	8/99	original issue
Rev A	4/00	changes for 400MHz processor
Rev B	10/00	changes for 128MB RAM
Rev C	04/01	changes for 566MHz processor

Introduction to the D4-470

In This Chapter. . . .

- About this Manual
- Overview of the D4-470
- Configuration Choices
- Accessories

Manual Overview

Purpose of this Manual

This manual describes the use and functionality of the **D4-470** Industrial PC. In the manual you will find specifications as well as application information. This manual is necessarily limited to the use of the product as it is configured by us. The many modifications that could be made to the D4-470 product cannot be covered here in detail. Some generic information is provided, however, to illustrate how modifications are made in general terms (e.g. installing third-party accessory boards).

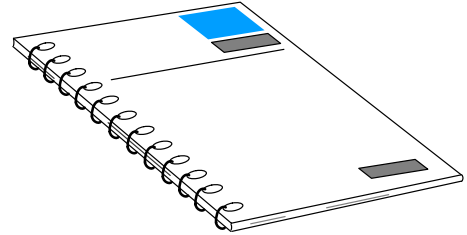

Other Reference Materials

In addition to this User Manual, you will receive at least two reference manuals with the D4-470. One is for the Operating System loaded on your D4-470, either Windows® 98, Windows® 2000 or Windows® NT. The other is for the CPU-board that is built into the unit you purchased.

Note: The CPU-board was set-up at the assembly point. You will not need to alter the setup unless modifications you are making require it.

You may also find the following manuals to be useful:

- Think & Do Software Learning Guide
- Lookout **Direct** (included with D4-470-LK)
- D2-INST-M or D4-INST-M Installation and I/O Manuals
- D2-ANLG-M or D4-ANLG-M for users of analog modules

Who Should Read This Manual

If you understand the basics about PCs and need to install the D4-470 or program an application to run on the D4-470, you should read this manual.

Technical Support

We strive to make our manuals the best in the industry. We rely on your feedback to let us know if we are reaching our goal. If you cannot find the solution to your particular application, or, if for any reason you need additional technical assistance, please call us at **770-844-4200**. Our technical support group is glad to work with you in answering your questions. They are available **weekdays from 9:00 a.m. to 6:00 p.m. Eastern Time**.

We also encourage you to visit our website where you can find technical and non-technical information about our products and our company.

<http://www.automationdirect.com>.

Key Topics for Each Chapter

The beginning of each chapter will list the key topics that can be found in that chapter.

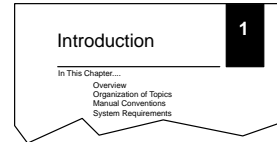

Chapters

Below is a table showing a summary of contents provided within each section of this manual. The manual is organized into the following chapters:

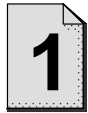

Introduction

presents the basic features of the D4-470 including a description of the six part numbers that make up the D4-470 product offering and a list of the accessories that come with the D4-470.

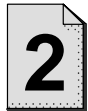

Installation, Wiring, and Specifications

explains what you need to consider before mounting and wiring the D4-470, describes the connections for power wiring and communications to other devices, and presents specifications for the D4-470.

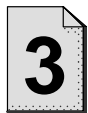

Installing Hardware Accessories

gives you a generic overview of the steps to take when adding third-party accessory boards in the ISA and PCI expansion slots. It also addresses connecting an internally powered CD-ROM drive.

Appendices

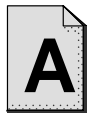

European Directives (CE)

provides CE information.

Special Symbols:



When you see the “exclamation mark” icon in the left-hand margin, the paragraph to its immediate right will be a **warning**. This information could prevent injury, loss of property, or even death.



When you see the “notepad” icon in the left-hand margin, the paragraph to its immediate right will be a **special note**. The word **NOTE:** in boldface will mark the beginning of the text.

D4-470 Overview

The D4-470 is an industrial PC intended for use with PC-based Control or Human Machine Interface (HMI) applications. It is compatible with **DirectLogic** I/O, but it can also be used with other input and output devices.

Compact Size

The D4-470's compact size allows it to fit comfortably into industrial control panels. The D4-470 offers hard and floppy disk drives, expansion slots and ports similar to a typical mini- or mid-tower PC. See the full specifications beginning on page 2-7.



Pentium Processor

The D4-470 comes with a 400MHz Pentium processor mounted in a ZIF socket to make upgrade possible. It ships with 128MB of RAM, expandable to 768MB. It has 4MB of Video RAM.

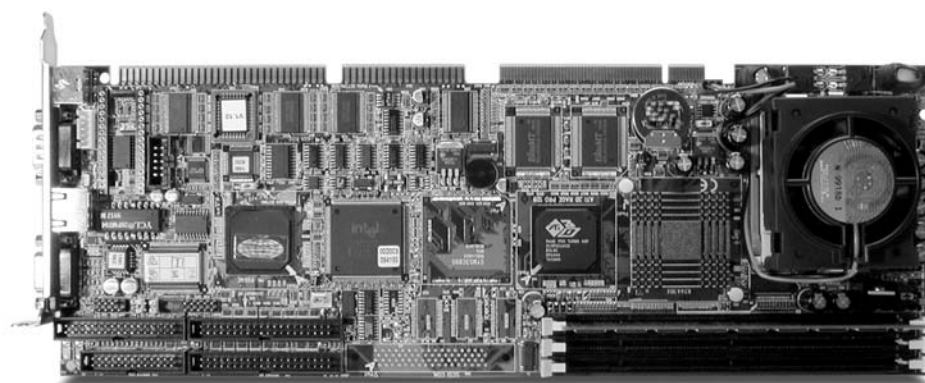

High-Speed I/O Connection

The on-board Ethernet port allows easy connection to the H2-EBC or H4-EBC and associated I/O. Use a hub to connect to multiple EBC's or use the H4-EBC's ability to connect to Expansion Bases.

Configuration Choices

The D4-470 Industrial PC is available in **six** configurations:



The **D4-470-98** comes with Windows® 98 preloaded.



The **D4-470-2K** comes with Windows® 2000 preloaded.



The **D4-470-NT** comes with Windows® NT preloaded.



The **D4-470-LKD** comes with Windows® 98 and the Lookout **Direct** Development Package preloaded.

The **D4-470-LKR** comes with Windows 98 and the Lookout **Direct** Runtime Package preloaded.



The **D4-470-2K-TDL** comes with Windows® NT and Think & Do Studio preloaded.

Accessories

In addition to the preloaded software, all models of the D4-470 come with the following features or accessories:

- Standard 101-key AT-style keyboard
- Two button mouse
- PS/2 Y-adapter used to connect the keyboard and mouse to the single PS/2 port
- Ribbon cables provided for connecting an additional IDE Device to the CPU-board (SCSI not supported)
- Floppy disks with various utility programs. Necessary drivers have been preloaded. There is no need to install additional drivers to operate the D4-470 in its standard configuration.
- Manufacturer's reference manual for the CPU-board

Installation, Wiring, and Specifications

In This Chapter. . . .

- Mounting and Wiring Guidelines
- Power Wiring
- Ports and Connectors
- Technical and Environmental Specifications
- Dimensions

Mounting and Wiring Guidelines

Panel Layout & Clearances

There are many things to consider when designing a panel layout. We suggest you consider the following items (but there may be additional requirements depending upon your application).

- The D4-470 must be mounted horizontally for proper ventilation.
- There should be a minimum of 7.2" between the D4-470 and the closest expansion base.
- A minimum clearance of 2" between the D4-470 and the top, bottom, and sides of the cabinet should be provided.
- There must be a minimum clearance of 2" between the panel door and the nearest D4-470, DL205 or DL405 component.
- Connect the ground terminal on the D4-470 to a single point ground. Use copper stranded wire to achieve a low impedance. Copper eye lugs should be crimped and soldered to the ends of the stranded wire to ensure good surface contact. Remove anodized finishes and use copper lugs and star washers at termination points. A rule of thumb is to achieve 0.1 Ω of DC resistance between the D4-470 base and the single point ground.
- There must be a single point ground (e.g. copper bus bar) for all devices in the panel requiring an earth ground return. The single ground point must be connected to the panel ground termination.

The panel ground termination must be connected to earth ground. For this connection you should use #12 AWG stranded copper wire as a minimum. Minimum wire sizes, color coding, and general safety practices should comply with appropriate electrical codes for your area. A good common ground reference (Earth ground) is essential for proper operation of the D4-470, which include:

- a) Installing a ground rod as close to the panel as possible.
 - b) Connection to incoming power system ground.
- Installations where the ambient temperature may approach the lower or upper limits of the specifications should be evaluated carefully. To do this place a temperature probe in the panel, close the door and operate the system until the ambient temperature has stabilized. If the ambient temperature is not within the operating specification for the D4-470, measures such as installing a cooling/heating source must be taken to get the ambient temperature within the D4-470 operating specifications.
 - Device mounting bolts and ground braid termination bolts should be #10 copper bolts or equivalent. Tapped holes instead of nut-bolt arrangements should be used whenever possible. To assure good ground contact on termination areas impediments such as paint, coating or corrosion should be removed in the area of contact.

Enclosures

Your selection of a proper enclosure is important to ensure safe and proper operation of your D4-470 system. Applications of D4-470 systems vary and may require additional features. The minimum considerations for enclosures include:

- Conformance to electrical standards
- Protection from the elements in an industrial environment
- Common ground reference
- Maintenance of specified ambient temperature
- Access to equipment
- Security or restricted access
- Sufficient space for proper installation, cooling, and maintenance

Agency Approvals

Some applications require agency approvals. The D4-470 has received the following agency approvals:

- UL (Underwriter's Laboratories, Inc.)
- CUL (Canadian Underwriter's Laboratories)

Power Wiring

The power wiring is attached to the terminals on the right side of the D4-470. Follow the legend on the upper right corner of the hinged lid as shown in the diagram below.

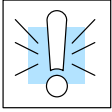

WARNING: Do not strip wire insulation more than 8–10mm, or approximately 0.3875 inches. Use spade or ring lugs if possible. Exposed conductors longer than this length could make contact with the metal case of the D4-470. Contact between the conductors and the case could be hazardous.

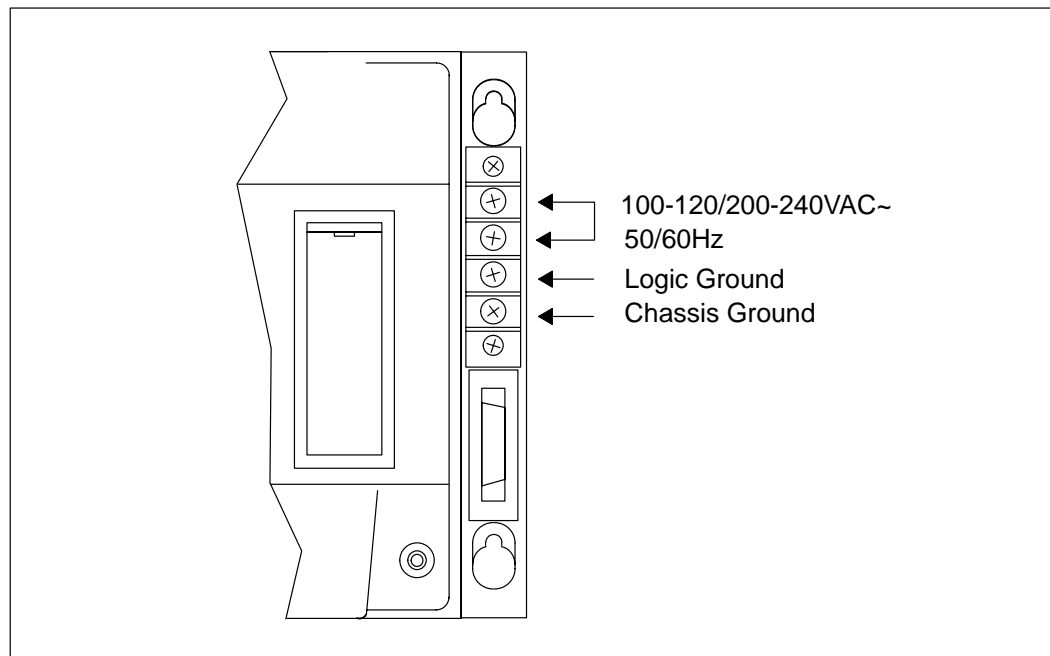

NOTE: We recommend including an on-off switch in the power circuit of the D4-470. This will make it easier to cycle power to the unit when necessary.

Internal Power Supply

The D4-470's internal power supply distributes power to the CPU-board, the CPU fan, the hard disk drive, and the floppy disk drive. Additional power is also available to power the expansion slots. Three voltages are provided to power internal devices: +5, +12, and -12 VDC. You will find the current limits for each voltage in the specifications on page 2-7. Be sure the total power consumption does not exceed the available power limits.

Power Supply Limitations

Many peripheral devices consume more power than the D4-470 can furnish. We recommend that you do not attempt to power external devices using the internal power supply. **Do not attempt to power a CD-ROM drive using the D4-470's internal power supply. Use an external power source.**

Ports and Connectors

Left Side

On the left side of the D4-470 you will find a standard 15-pin port for your VGA monitor. Follow the recommendations of your monitor's manufacturer in setting up your monitor. The 10/100 Base-T port is compatible with our Ethernet Base Controller or our Ethernet Communications Module. See the manual for those devices for more information about developing or connecting to an Ethernet network. This port is also compatible with standard hubs, routers, etc.

Connect the Y-adapter that came with the D4-470 to the PS/2 connector. The keyboard and mouse that also came with the D4-470 will connect to the other ends of the Y-adapter. Both devices can be used simultaneously with conflict.

As shown below, two serial ports and a parallel port are also provided. Any accessory boards you add will also have ports on the left side of the D4-470.

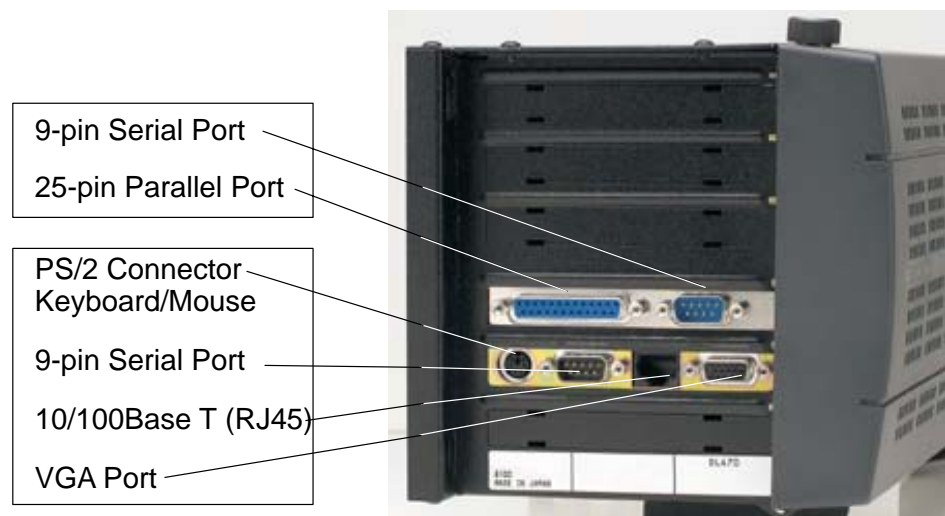

Right Side

The two USB ports are on the far right side of the D4-470 lid. USB ports are supported by Windows® 98 and Windows® 2000, but at this time they are not supported by Windows® NT. An active DL405 expansion port is located next to the power connections. This port is provided for future use by PC-based Control developers. Software drivers are not currently available to support its use. There is a SCSI2 port located in a recess covered by a snap out plastic door. The SCSI2 is not supported by the PCA 6168 CPU card.

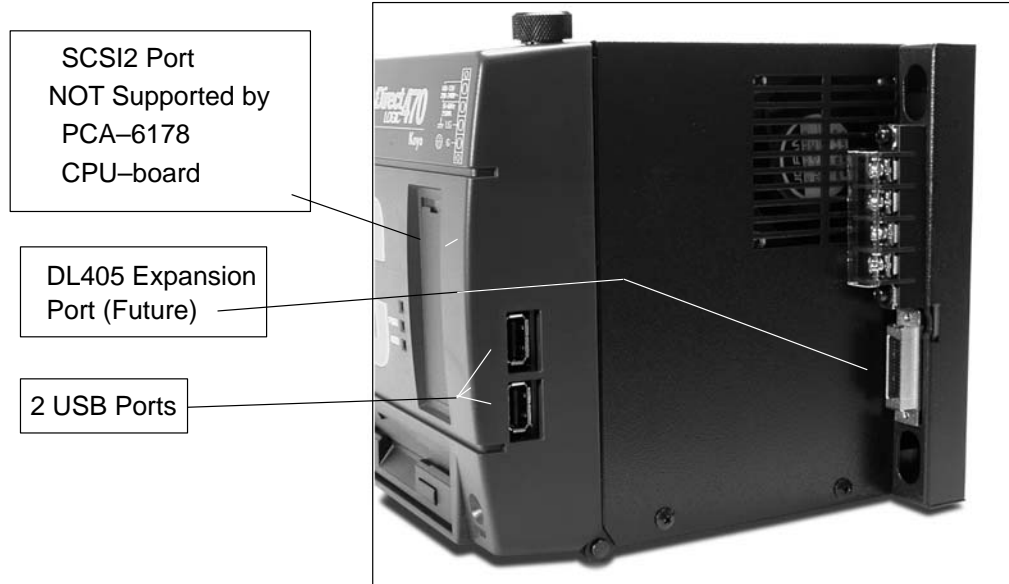

Technical and Environmental Specifications

General Specifications of the D4-470

Item	Specification
External Power Supply	94-120 VAC / 190/240 VAC (Autochange) 50-60Hz
Acceptable Range	85-132 VAC / 170/265 VAC (Autochange) 47-63 Hz
Power Consumption	Max. 250 VA
Internal Power Supply Output Voltage/Current	Max. 5 VDC / 15 A, +12 VDC / 2.3 A, -12 VDC / 0.1 A
Voltage/Current supplied to the Expansion Cards	Max. 5 VDC / 8 A, +12 VDC / 2.1 A, -12 VDC / 0.08 A
Acceptable External Power Drop	Max. 10 ms
Operating Temperature	41-122°F (5-50°C)
Storage Temperature	-4-140°F (-20-60°C)
Operating Humidity	30-80%
Storage Humidity	30-90%
Atmosphere	No corrosive gases, the level for environmental pollution = 2. (UL 840)
Vibration Resistance	Operating: 4.9m/s ² , 5-500Hz (Sine wave) Not Operating: 19.6m/s ² , 5-500Hz (Sine wave)
Shock Resistance	Operating: 392m/s ² , Half-sine wave, 11ms Not Operating: 784m/s ² , Half-sine wave, 11ms
Voltage Withstand	1500VAC
Insulation Resistance	500VDC, 10MΩ
Noise Immunity	Comply with NEMA ICS3-304, impulse 1us 1000V FCC CLASS A
Size	17.36W x 5.9H x 6.3D (in.) / 441W x 150H x 160D (mm)
Weight	5200g
Agency Approvals	UL, CUL

Functional Specifications

Item	Specification
CPU	Intel Celeron® 566MHz processor Replaceable with Socket 370 Pentium® III or Celeron® Processors up to 850MHz
BIOS	AWARD: Flash BIOS, Plug & Play supported, 2Mbit
Chip Set	Intel® 82440BX
Main Memory	168-pin DIMM slot x 3, Max. 768MB SDRAM One stick 128MB pre-installed; 16, 32, 64, 128, or 256MB DIMMs are available (use PC100-compliant)
Cache	128 KB on CPU L2
Video Port	ATI: 3D Rage Pro Turbo VGA controller, Display memory 4MB Max: 1280 x 1024, 24 bit colors Max: 1152 x 864, 32 bit colors 15 pin VGA connector
Keyboard/Mouse Port	PC/AT keyboard supported (Mini DIN 6-pin) D4-470 comes with Y-adapter cable (Mini DIN 6-pin to DIN 5-pin + Mini DIN 6-pin) A keyboard and mouse can be used simultaneously with this adapter
FDD	3.5" FDD (1.44MB/720KB) x 1
IDE HD Interface	2.5" HD bay x 2 (One bay has a 6.0GB HD, the other bay is unoccupied) The height of HD must be less than 9.5mm Transfer speed: 16.67 MB/sec (PIO transfer mode 4) 33MB/sec (Ultra DMA/33 transfer)
Serial Port	2 Ports COM1, 2: RS-232C, 9-pin D-sub connector 16C550 compatible UART Max. 115.2kbps
Parallel Port	1 Port 25-pin D-sub connector This port supports the following modes: SPP (Standard Parallel Port) EPP (Enhanced Parallel Port) ECP (Extended Capabilities Port)
LAN Port	1 Port RJ-45 connector Chipset: Intel 82558 Supports 10/100 Base-T Ethernet networking
SCSI port	Not Supported- No SCSI Interface on CPU-board

Functional Specifications (cont'd)

Item	Specification																		
USB Port	2 Ports, electronically fused USB Type A connector USB Rev 1.0																		
DL405 I/O Expansion Port	Future use																		
Expansion Slot	4 Slots Maximum size of board PCI/ISA slot x 1: 4.8H x 13.3L (inches) 122H x 338L (mm) PCI slot x 2 4.8H x 7.1L (inches) 122H x 180L (mm) 4.8H x 6.7L (inches) 122H x 170L (mm) ISA slot x 1 4.8H x 7.3L (inches) 122H x 185L (mm)																		
RTC/CMOS Backup	Lithium battery (on the CPU board) Battery life of 7 years (77°F - 25°C)																		
LED Indicator	2 Indicators PWR: On when the DC power supply provides 5VDC to the CPU board HDD: On when the internal HDD is accessed																		
Reset Switch	1 Switch																		
Fan	5VDC																		
Terminal Block for the External Power Supply	<table border="0"> <tr> <td>○</td> <td></td> <td></td> </tr> <tr> <td>⊖</td> <td>AC Power</td> <td>□ 94-120VAC/190-240VAC</td> </tr> <tr> <td>⊖</td> <td>AC Power</td> <td></td> </tr> <tr> <td>⊖</td> <td>LG: Logic ground</td> <td></td> </tr> <tr> <td>⊖</td> <td>G: Frame ground</td> <td></td> </tr> <tr> <td>○</td> <td></td> <td></td> </tr> </table> <p>Logic ground and frame ground are internally connected</p>	○			⊖	AC Power	□ 94-120VAC/190-240VAC	⊖	AC Power		⊖	LG: Logic ground		⊖	G: Frame ground		○		
○																			
⊖	AC Power	□ 94-120VAC/190-240VAC																	
⊖	AC Power																		
⊖	LG: Logic ground																		
⊖	G: Frame ground																		
○																			

Dimensions

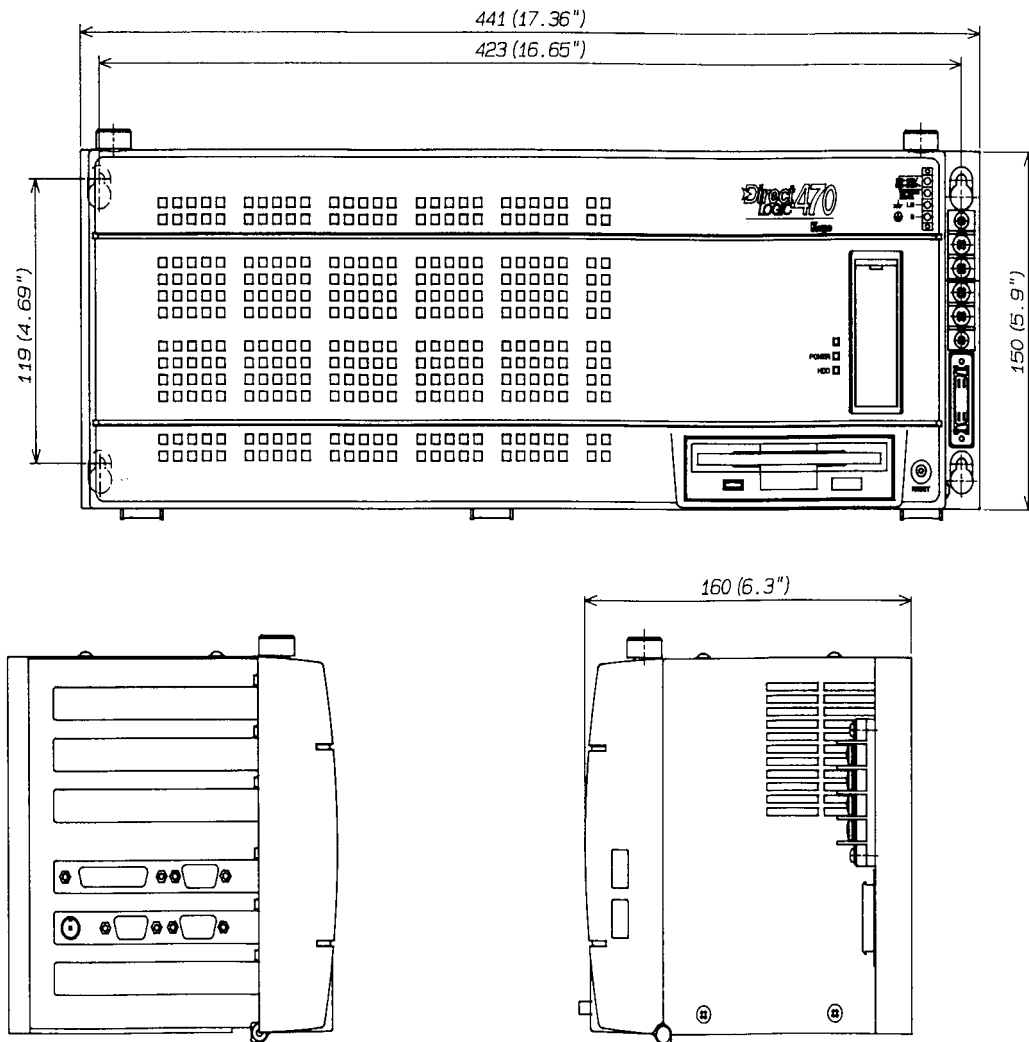

Installing Hardware Accessories

In This Chapter. . . .

- Adding Third-party Boards to Expansion Slots
- Installing Additional RAM Memory
- CPU Board and DIMM Sockets
- Powering Internal and External Devices
- Changing the CPU

Adding Third-Party Boards to Expansion Slots

Loosen the two thumb screws on the hinged lid of the D4-470 to open the lid and expose the interior of the case. The compartment is compact but accessible. Remove the two screws that hold the upper card edge bracket in place and remove the bracket.



WARNING: To minimize the risk of electrical shock, personal injury, or equipment damage, always turn off the system power before opening the case of the D4-470 and before connecting peripheral devices to the D4-470.

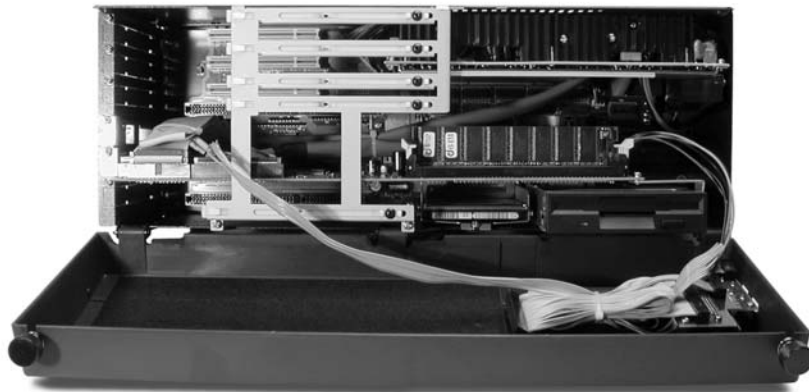

As you will notice in the photo below, we removed the backplane circuit board from the D4-470 case to facilitate viewing. *Do not* remove the backplane board to install expansion boards.

Four ISA and PCI Expansion Slots

Viewed as shown below, the PCI slots use the three white connectors indicated. The ISA slots use the black connectors also identified below. The third PCI connector from the top and upper ISA connector occupy the same slot position. This is the full length slot. It can be used as either a PCI or ISA slot but not both.



Take care not to uncouple any cable connectors while installing accessory boards, and be sure the boards you are installing are fully seated into the appropriate connectors. Re-install the upper card edge bracket after installing new circuit boards.

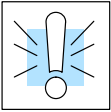

Knock-out Panels

WARNING: Use grounding straps or other appropriate anti-static safeguards when handling electronic circuit boards to prevent damage to electronic components.

The expansion slots are covered by knock-out panels. Carefully pry the knock-out panel from the case using a blade screwdriver or similar tool. After prying out the Knock-out, press your expansion board firmly into the card-edge connector. A screw is provided to secure the expansion board bracket to the case. Follow the expansion board manufacturer's recommendations for set-up.

Windows® 98 supports Plug & Play features but Windows® NT does not. New boards which are Plug & Play compatible will be recognized by Windows® 98 on power up.



We do not offer technical support for third party expansion boards. We also do not guarantee the compatibility between any third-party products and the D4-470. The D4-470 is a standard PC, however, and can be expected to perform normally with most PC accessory products.

Installing Additional RAM Memory

The D4-470 comes equipped with 128MB of RAM. You do not need to add RAM memory if 128MB of RAM is sufficient for your application.

The three 168-pin DIMM (Dual In-line Memory Module) sockets on the D4-470 support PC100-compliant SDRAMs. The sockets can be filled in any combination of DIMMs of any size up to 768 MB of memory.

Installing the Memory

Prior to installing the DIMMs, first make sure the two handles of the DIMM socket are in the open position (i.e. the handles lean outward). Slide the DIMM slowly along the plastic guides on both ends of the socket. Then press the DIMM module straight down into the socket until you hear a click. Note that the two DIMM socket handles have automatically locked the memory module in place.

To remove the memory module, gently push the two handles outward simultaneously. This will eject the memory from the DIMM socket.

Dual In-line Memory Module

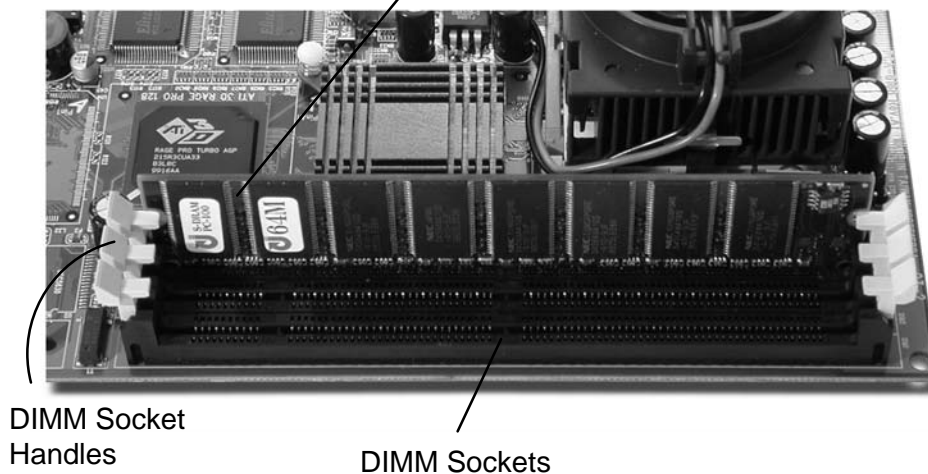

NOTE: It is not necessary to remove the CPU-board to install additional DIMMs.

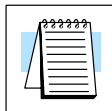

Powering Internal and External Devices

See the specifications in Chapter 2 to determine whether the D4-470's internal power supply is adequate to power internal accessory devices. Use external power *only* for CD-ROM drives and other external devices. The D4-470 power supply is *not* designed to power external devices.

Changing the CPU

Because of the range of choices and the complexity of setup when you change CPUs, we are unable to offer technical support or warranty coverage in the event that a CPU change is made.

European Union Directives (CE)

In This Appendix. . . .

- European Union (EU) Directives
- Basic EMC Installation Guidelines

European Union (EU) Directives



NOTE: The information contained in this section is intended as a guideline and is based on our interpretation of the various standards and requirements. Since the actual standards are issued by other parties and in some cases Governmental agencies, the requirements can change over time without advance warning or notice. Changes or additions to the standards can possibly invalidate any part of the information provided in this section.

This area of certification and approval is absolutely vital to anyone who wants to do business in Europe. One of the key tasks that faced the EU member countries and the European Economic Area (EEA) was the requirement to bring several similar yet distinct standards together into one common standard for all members. The primary purpose of a single standard was to make it easier to sell and transport goods between the various countries and to maintain a safe working and living environment. The Directives that resulted from this merging of standards are now legal requirements for doing business in Europe. Products that meet these Directives are required to have a CE mark to signify compliance.

Member Countries

As of January 1, 1997, the members of the EU are Austria, Belgium, Denmark, Finland, France, Germany, Greece, Ireland, Italy, Luxembourg, The Netherlands, Portugal, Spain, Sweden, and the United Kingdom. Iceland, Liechtenstein, and Norway together with the EU members make up the European Economic Area (EEA) and all are covered by the Directives.

Applicable Directives

There are several Directives that apply to our products. Directives may be amended, or added, as required.

- **Electromagnetic Compatibility Directive (EMC)** — this Directive attempts to ensure that devices, equipment, and systems have the ability to function satisfactorily in its electromagnetic environment without introducing intolerable electromagnetic disturbance to anything in that environment.
- **Machinery Safety Directive** — this Directive covers the safety aspects of the equipment, installation, etc. There are several areas involved, including testing standards covering both electrical noise immunity and noise generation.
- **Low Voltage Directive** — this Directive is also safety related and covers electrical equipment that has voltage ranges of 50–1000VAC and/or 75–1500VDC.
- **Battery Directive** — this Directive covers the production, recycling, and disposal of batteries.

Compliance

Certain standards within each Directive already require mandatory compliance. The EMC Directive, which has gained the most attention, became mandatory as of January 1, 1996. The Low Voltage Directive became mandatory as of January 1, 1997.

Ultimately, we are all responsible for our various pieces of the puzzle. As manufacturers, we must test our products and document any test results and/or installation procedures that are necessary to comply with the Directives. As a machine builder, you are responsible for installing the products in a manner which will ensure compliance is maintained. You are also responsible for testing any combinations of products that may (or may not) comply with the Directives when used together.

The end user of the products must comply with any Directives that may cover maintenance, disposal, etc. of equipment or various components. *Although we strive to provide the best assistance available, it is impossible for us to test all possible configurations of our products with respect to any specific Directive. Because of this, it is ultimately your responsibility to ensure that your machinery (as a whole) complies with these Directives and to keep up with applicable Directives and/or practices that are required for compliance.*

As of January 1, 1999, the DL05, DL205, DL305, and DL405 PLC systems manufactured by Koyo Electronics Industries or FACTS Engineering, when properly installed and used, conform to the Electromagnetic Compatibility (EMC), Low Voltage Directive, and Machinery Directive requirements of the following standards.

- **EMC Directive Standards Relevant to PLCs**
 - EN50081-1 Generic emission standard for residential, commercial, and light industry
 - EN50081-2 Generic emission standard for industrial environment.
 - EN50082-1 Generic immunity standard for residential, commercial, and light industry
 - EN50082-2 Generic immunity standard for industrial environment.
- **Low Voltage Directive Standards Applicable to PLCs**
 - EN61010-1 Safety requirements for electrical equipment for measurement, control, and laboratory use.
- **Product Specific Standard for PLCs**
 - EN61131-2 Programmable controllers, equipment requirements and tests. This standard replaces the above generic standards for immunity and safety. However, the generic emissions standards must still be used in conjunction with the following standards:
 - EN 61000-3-2—Harmonics
 - EN 61000-3-2—Fluctuations
Automationdirect.com is currently in the process of changing their testing procedures from the generic standards to the product specific standards.

Special Installation Manual

The installation requirements to comply with the requirements of the Machinery Directive, EMC Directive and Low Voltage Directive are slightly more complex than the normal installation requirements found in the United States. To help with this, we have published a special manual which you can order:

- **DA-EU-M** – EU Installation Manual that covers special installation requirements to meet the EU Directive requirements. Order this manual to obtain the most up-to-date information.

Other Sources of Information

Although the EMC Directive gets the most attention, other basic Directives, such as the Machinery Directive and the Low Voltage Directive, also place restrictions on the control panel builder. Because of these additional requirements it is recommended that the following publications be purchased and used as guidelines:

- BSI publication TH 42073: February 1996 – covers the safety and electrical aspects of the Machinery Directive
- EN 60204-1:1992 – General electrical requirements for machinery, including Low Voltage and EMC considerations
- IEC 1000-5-2: EMC earthing and cabling requirements
- IEC 1000-5-1: EMC general considerations

It may be possible for you to obtain this information locally; however, the official source of applicable Directives and related standards is:

The Office for Official Publications of the European Communities
L-2985 Luxembourg; quickest contact is via the World Wide Web at
<http://euro-op.eu.int/indexn.htm>

Another source is:

British Standards Institution – Sales Department
Linford Wood
Milton Keynes
MK14 6LE
United Kingdom; the quickest contact is via the World Wide Web at
<http://www.bsi.org.uk>

Basic EMC Installation Guidelines

Enclosures

The simplest way to meet the safety requirements of the Machinery and Low Voltage Directives is to house all control equipment in an industry standard lockable steel enclosure. This normally has an added benefit because it will also help ensure that the EMC characteristics are well within the requirements of the EMC Directive. Although the RF emissions from the PLC equipment, when measured in the open air, are well below the EMC Directive limits, certain configurations can increase emission levels. Holes in the enclosure, for the passage of cables or to mount operator interfaces, will often increase emissions.

AC Mains Filters

DL05, DL205 and DL305 AC powered base power supplies require extra mains filtering to comply with the EMC Directive on conducted RF emissions. All PLC equipment has been tested with filters from Schaffner, which reduce emissions levels if the filters are properly grounded (earth ground). A filter with a current rating suitable to supply all PLC power supplies and AC input modules should be selected. We suggest the FN2010 for DL05/DL205 systems and the FN2080 for DL305 systems. DL405 systems do not require extra filtering.

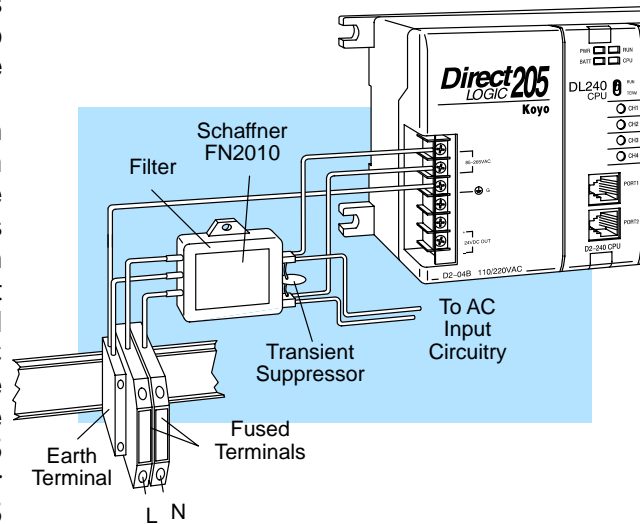

NOTE: Very few mains filters can reduce problem emissions to negligible levels. In some cases, filters may increase conducted emissions if not properly matched to the problem emissions.

Suppression and Fusing

In order to comply with the fire risk requirements of the Low Voltage and Machinery Directive electrical standards EN 61010-1, and EN 60204-1, by limiting the power into “unlimited” mains circuits with power leads reversed, it is necessary to fuse both AC and DC supply inputs. You should also install a transient voltage suppressor across the power input connections of the PLC. Choose a suppressor such as a metal oxide varistor, with a rating of 275VAC working voltage for 230V nominal supplies (150VAC working voltage for 115V supplies) and high energy capacity (eg. 140 joules).

Transient suppressors must be protected by fuses and the capacity of the transient suppressor must be greater than the blow characteristics of the fuses or circuit breakers to avoid a fire risk. A recommended AC supply input arrangement for Koyo PLCs is to use twin 3 amp TT fused terminals with fuse blown indication, such as DINnectors DN-F10L terminals, or twin circuit breakers, wired to a Schaffner FN2010 filter or equivalent, with high energy transient suppressor soldered directly across the output terminals of the filter. PLC system inputs should also be protected from voltage impulses by deriving their power from the same fused, filtered, and surge-suppressed supply.

Internal Enclosure Grounding

A heavy-duty star earth terminal block should be provided in every cubicle for the connection of all earth ground straps, protective earth ground connections, mains filter earth ground wires, and mechanical assembly earth ground connections. This should be installed to comply with safety and EMC requirements, local standards, and the requirements found in IEC 1000-5-2. The Machinery Directive also requires that the common terminals of PLC input modules, and common supply side of loads driven from PLC output modules should be connected to the protective earth ground terminal.

Equi-potential Grounding

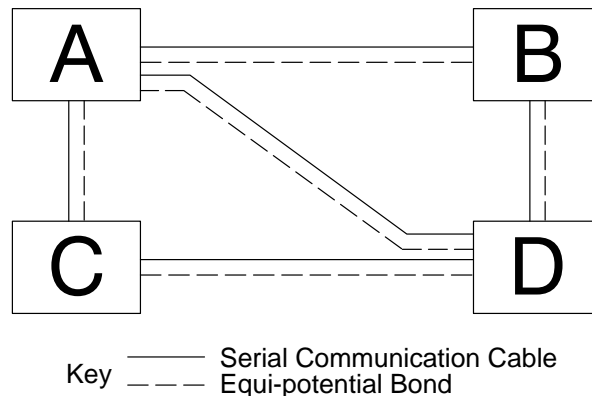

Adequate site earth grounding must be provided for equipment containing modern electronic circuitry. The use of isolated earth electrodes for electronic systems is forbidden in some countries. Make sure you check any requirements for your particular destination. IEC 1000-5-2 covers equi-potential bonding of earth grids adequately, but special attention should be given to apparatus and control cubicles that contain I/O devices, remote I/O racks, or have inter-system communications with the primary PLC system enclosure. An equi-potential bond wire must be provided alongside all serial communications cables, and to any separate items of the plant which contain I/O devices connected to the PLC. The diagram shows an example of four physical locations connected by a communications cable.

Communications and Shielded Cables

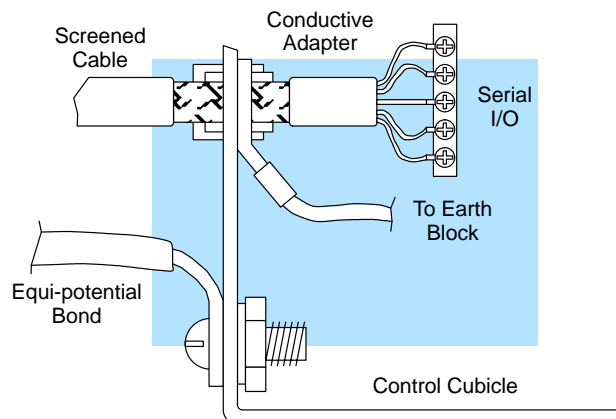

Good quality 24 AWG minimum twisted-pair shielded cables, with overall foil and braid shields are recommended for analog cabling and communications cabling outside of the PLC enclosure. To date it has been a common practice to only provide an earth ground for one end of the cable shield in order to minimize the risk of noise caused by earth ground loop currents between apparatus. The procedure of only grounding one end, which primarily originated as a result of trying to reduce hum in audio systems, is no longer applicable to the complex industrial environment. Shielded cables are also efficient emitters of RF noise from the PLC system, and can interact in a parasitic manner in networks and between multiple sources of interference.

The recommendation is to use shielded cables as electrostatic “pipes” between apparatus and systems, and to run heavy gauge equi-potential bond wires alongside all shielded cables. When a shielded cable runs through the metallic wall of an enclosure or machine, it is recommended in IEC 1000-5-2 that the shield should be connected over its full perimeter to the wall, preferably using a conducting adapter, and not via a pigtail wire connection to an earth ground bolt. Shields must be connected to every enclosure wall or machine cover that they pass through.

Analog and RS232 Cables

Providing an earth ground for both ends of the shield for analog circuits provides the perfect electrical environment for the twisted pair cable as the loop consists of signal and return, in a perfectly balanced circuit arrangement, with connection to the common of the input circuitry made at the module terminals. RS232 cables are handled in the same way.

Multidrop Cables

RS422 twin twisted pair, and RS485 single twisted pair cables also require a 0V link, which has often been provided in the past by the cable shield. It is now recommended that you use triple twisted pair cabling for RS422 links, and twin twisted pair cable for RS485 links. This is because the extra pair can be used as the 0V inter-system link. With loop DC power supplies earth grounded in both systems, earth loops are created in this manner via the inter-system 0v link. The installation guides encourage earth loops, which are maintained at a low impedance by using heavy equi-potential bond wires. **To account for non-European installations using single-end earth grounds, and sites with far from ideal earth ground characteristics, we recommend the addition of 100 ohm resistors at each 0V link connection in network and communications cables.**

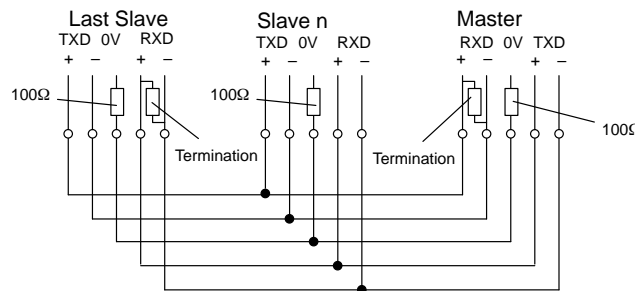

Shielded Cables within Enclosures

When you run cables between PLC items within an enclosure which also contains susceptible electronic equipment from other manufacturers, remember that these cables may be a source of RF emissions. There are ways to minimize this risk. Standard data cables connecting PLCs and/or operator interfaces should be routed well away from other equipment and their associated cabling. You can make special serial cables where the cable shield is connected to the enclosure’s earth ground at both ends, the same way as external cables are connected.

Network Isolation

For safety reasons, it is a specific requirement of the Machinery Directive that a keyswitch must be provided that isolates any network input signal during maintenance, so that remote commands cannot be received that could result in the operation of the machinery. The FA-ISONET does not have a keyswitch! Use a keylock and switch on your enclosure which when open removes power from the FA-ISONET. To avoid the introduction of noise into the system, any keyswitch assembly should be housed in its own earth grounded steel box and the integrity of the shielded cable must be maintained.

Again, for further information on EU directives we recommend that you get a copy of our EU Installation Manual (DA-EU-M). Also, if you are connected to the World Wide Web, you can check the EU Commission’s official site at: <http://eur-op.eu.int/>

Items Specific to the D4-470

- The equipment is suitable for installation category 1 or 2.
- Only parts supplied by Automationdirect.com, or its agents should be used.
- The rating between all circuits in this product are rated as **basic insulation only**, as appropriate for single fault conditions.
- It is the responsibility of the system designer to earth one side of all control and power circuits, and to earth the braid of screened cables.
- This equipment must be properly installed while adhering to the guidelines of the in house equipment installation manual DA-EU-M, and the installation standards IEC 1000-5-1, IEC 1000-5-2 and IEC 1131-4.
- It is a requirement that this equipment must be housed in a protective steel enclosure, which limits access to operators by a lock and power breaker. If access is required by operators or untrained personnel, the equipment must be installed inside an internal cover or secondary enclosure.
- It should be noted that the safety requirements of the machinery directive standard EN60204-1 state that all equipment power circuits must be wired through isolation transformers or isolating power supplies, and that one side of all AC or DC control circuits must be earthed.
- Both power input connections to the equipment must be separately fused using 3 amp T type anti-surge fuses, and a transient suppressor fitted to limit supply overvoltages.
- If this equipment is used in a manner not specified by the manufacturer the protection provided by the equipment may be impaired.

Maintenance of the D4-470

- The D4-470 CMOS backup battery has a life of 7 years.
- With the equipment power supply turned off, use a vacuum cleaner to remove dust from the power supply ventilation slots and the chassis cooling fan as needed.

Free Manuals Download Website

<http://myh66.com>

<http://usermanuals.us>

<http://www.somanuals.com>

<http://www.4manuals.cc>

<http://www.manual-lib.com>

<http://www.404manual.com>

<http://www.luxmanual.com>

<http://aubethermostatmanual.com>

Golf course search by state

<http://golfingnear.com>

Email search by domain

<http://emailbydomain.com>

Auto manuals search

<http://auto.somanuals.com>

TV manuals search

<http://tv.somanuals.com>