

JVC

DIGITAL VIDEO CAMERA
LINEUP CATALOGUE

JVC – Your Interface With The World Of Multimedia

Plug into the future with JVC. From digital video cameras and double-deck MiniDV/S-VHS recorders to powerful software and convenient accessories, JVC is your complete source for multimedia products.



A Comprehensive Selection Multimedia Products To Meet Any Needs

JVC MiniDV Digital Video Cameras — Your Gateway To The World Of Multimedia



From the compact mobile-type to professional shooting model, JVC offers a complete line of MiniDV cameras. Each model is equipped with a variety of multimedia interfaces and features that let you make the most of your recorded images and sound. All models feature a DV (i.Link) terminal for fast, lossless digital transfer, while DSC-equipped models also feature a USB terminal for convenient, high-speed data transfer. Removable media such as SD Memory Cards and MultiMediaCards make it really easy to transfer data to a computer. JVC effectively links audio-visual sources and your PC, creating a smooth and cohesive multimedia environment for you to enjoy.

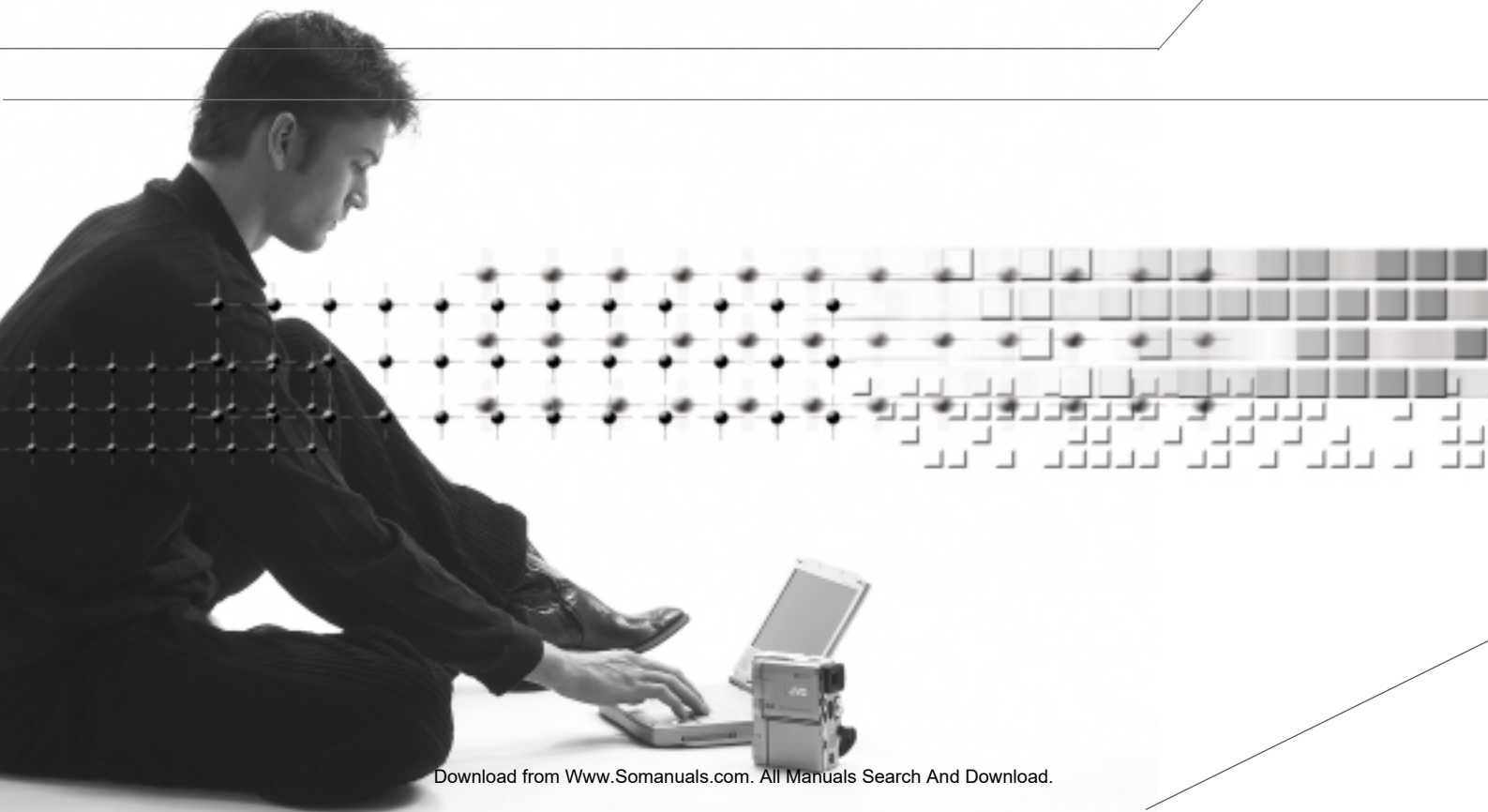

From the first take to the final cut, JVC has got the tools you need to transform your personal vision into a multimedia masterpiece. Simple enough for beginners, yet advanced enough for the most demanding professionals, JVC offers a comprehensive selection of multimedia products to make it easy for everyone to explore new creative vistas.

Of



JLIP™

**High-Value Software —
A Complete Production Package**



With JVC, all the software you need to produce a high-quality finished multimedia production is available. You'll be able to file images, create catalogues, photo albums and customised portfolios.

**JVC Accessories —
Expanding Your Options**



As you become familiar with the enormous potential of JVC multimedia, you'll want to take advantage of the wide variety of accessories available from JVC. These include a power option, various lenses, camera cases, cables, multimedia items, and more. We've also got high-resolution colour printers to output your multimedia productions

**The Ultimate Editing VCR —
DV/S-VHS Dual Deck**



Bridging the gap between MiniDV and VHS, the HR-DVS dual deck series offer an easy solution for editing and making S-VHS or VHS dubs of DV masters. With enhanced PC connectivity, batch editing capabilities, or built-in transition effects, these decks provide a solid foundation for your own professional-level editing suite.



Introduction	P2—3
GR-DVP3/DVP1	P4—5
GR-DV2000/1800	P6—7
GR-DVX88/77/44	P8—9
GR-DVL557/555/450/357/355/157/150	P10—11
Software and Accessories	P12—13
HR-DVS2/DVS1	P14—15

microPocket DV — the new style in digital video

New style DV for a new style of life. Ultra-compact and ultra-stylish, the GR-DVP3/1 is the first digital video camera that's designed for your lifestyle. With its full-flat body, the GR-DVP3/1 is small enough to slip into your pocket, yet it also offers incredible picture performance and multimedia capabilities. microPocket DV brings a whole new style to digital video.



MPEG4

● MPEG4 Video Clips For Email

At the touch of a button, the MPEG4 Video Clips For Email function allows you to instantly create multi-platform compatible video clips that can be viewed on most computer systems using pre-installed or easily available viewer software*. Based on today's most advanced video compression standard, MPEG4's small file size makes it ideal for attaching to email or posting on the Web.

* For Windows® computer, Windows Media™ Player ver. 6 or later is required.
For Macintosh® computer, Windows Media™ Player for Macintosh is required.

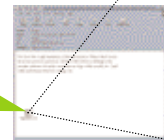

Simulated picture

Up to 20-sec. movies with sound can be converted into MPEG4 and stored on the SD Memory Card/MultiMediaCard

● Super High-Band Processor For 520 Lines Of Horizontal Resolution

The Super High-Band Processor intelligently calculates and restores the high-band components of the luminance signal that would be lost in conventional processing. This ensures extremely high horizontal resolution of 520 lines.

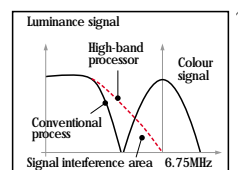

Frequency characteristics of CCD output

GR-DVP3

High-Band Digital Video Camera

- ❑ 520 lines of horizontal resolution with Super High-Band Processor
- ❑ Built-in HG digital still camera (XGA/VGA)
- ❑ MPEG4 Video Clips for Email
- ❑ Digital Sound Effects (MP3)
- ❑ SD Memory Card slot with MultiMediaCard compatibility
- ❑ USB high-speed interface
- ❑ DV input/output
- ❑ 10x optical/100x digital zoom with spline interpolation

- ❑ Digital NightScope for extreme low-light shooting
- ❑ 2" high-resolution colour LCD monitor
- ❑ Dimensions (W x H x D): 43 x 115 x 80mm
- ❑ Weight: 340g without battery and tape; 410g with battery and tape

GR-DVP1

High-Band Digital Video Camera

The GR-DVP1 comes with a sophisticated silver finish and has all the features provided on the GR-DVP3 except for DV (i.LINK) input capability.



Dark grey and silver finish

GR-DVP3

HIGH-BAND DIGITAL VIDEO CAMERA

Silver finish

GR-DVP1

HIGH-BAND DIGITAL VIDEO CAMERA

● Digital Sound Effects (MP3)



Available on the provided SD Memory Card/MultiMediaCard, these sound effects (MP3 format) can be inserted into a recording at any time — either during shooting or afterwards during editing. Among the effects provided are: Applause, Cheering, Laughter, Explosion, Buzzer, Siren, and Fanfare. You can also visit JVC's website and choose from an even wider range of sound effects and background music available for download.

More sound effects downloadable at:
<http://www.jvc-victor.co.jp/english/download/d-sound/index.html>

MP3



● Info-Shoe For Various Accessories

Dress up your camera for any occasion with a variety of optional attachments. The exclusive hot-shoe supplies power to the attached accessory and acts as conduit for control signals. Just attach these accessories to the Info-Shoe, and you're ready for any shooting opportunity.



- ① **Auto Light**
Automatically brightens the scene if existing light is insufficient while you're shooting video.*
* Manual on/off operation also possible
- ② **Video Flash**
For brilliant digital stills and video snapshots with adjustable brightness level.
- ③ **Stereo Zoom Microphone**
Accurately picks up sound relative to subject distance as you zoom in or zoom out.

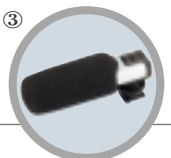
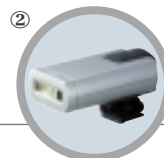
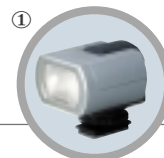

All screen images are simulated

Ultra-high resolution video and megapixel digital stills — uncompromised performance for video enthusiasts



If you're looking for a camera that does it all and does it better, look no further. With an advanced camera section featuring an AIS lens and a Progressive Scan CCD, these versatile cameras produce the best possible quality images whether you're shooting high-resolution digital video or UXGA digital stills. If serious performance is what you want, choose the GR-DV2000/1800.

Progressive Scan CCD with Progressive Colour Filter — 520 lines of horizontal by 576 lines of vertical



JVC has employed an advanced array of picture-improvement technologies to ensure superb image quality. The backbone of these technologies is a **progressive scan CCD** which provides extremely high resolution – recording images ideal for playback, printing, or capturing to a computer. JVC's **progressive colour filter** works in tandem with the progressive scan CCD to provide increased sensitivity and picture quality by raising vertical resolution to 576 lines (in Progressive mode).

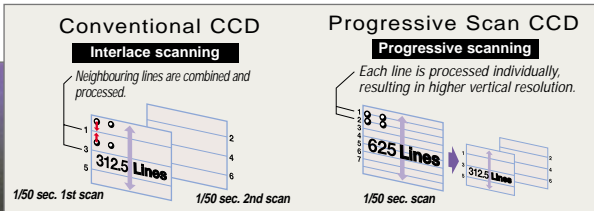

Dual Shooting Mode

Lets you shoot motion video and still pictures simultaneously. Just push the Snapshot button in the Dual mode and a VGA still picture is recorded on the SD Memory Card or MultiMediaCard while you continue taping video. You can take a snapshot any time without stopping video recording so you'll never miss any action even while shooting a still.

UXGA (1600 x 1200) 1.92 Megapixel Digital Stills with Pixel Shift Technology

A combination of JVC's AIS (Accurate Image Shift) Lens and 800K-pixel Progressive Scan CCD makes this possible. In this mode, for each shot, the image is first sampled with all the pixels in their usual locations, and within a split second, the image is double-exposed while shifting diagonally 1/2-pixel's worth. This pixel shift technology, along with JVC's unique interpolation method, is able to generate a UXGA-size picture with 1600 x 1200-pixel resolution — the same 1.92 megapixel image size you'd get with the high-grade digital still cameras.

Note: Only optical zoom (2x max.) is possible in UXGA mode. In cases where there is excessive camera-shake or with certain low-contrast images, a single exposure will be processed to generate a UXGA picture.

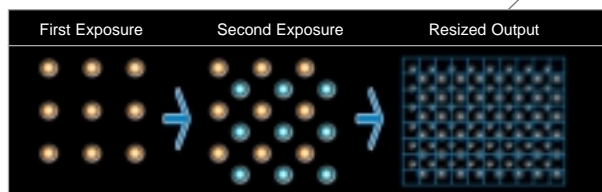

UXGA 1.92
Megapixel Digital Still

FEATURE LISTS

GR-DV2000

High-Band Digital Video Camera

- ❑ 576 lines of vertical resolution with Progressive Scan CCD (in Progressive mode)
- ❑ 520 lines of horizontal resolution with Super High-Band Processor
- ❑ UXGA 1.92 megapixel digital stills with Pixel Shift Technology
- ❑ Dual Shooting mode
- ❑ SLR-type operation with real-touch manual focus ring
- ❑ SD Memory Card slot with MultiMediaCard compatibility
- ❑ USB high-speed interface



- ❑ DV input/output
- ❑ 10x optical/300x super digital zoom with spline interpolation
- ❑ 3.5" high-resolution colour LCD monitor
- ❑ Dimensions (W x H x D): 74 x 90 x 178mm
- ❑ Weight: 660g without battery and tape; 740g with battery and tape

GR-DV1800

High-Band Digital Video Camera

The GR-DV1800 has all the features provided on the GR-DV2000 except for DV (i.LINK) input and analogue input capabilities.



GR-DV2000/1800

HIGH-BAND DIGITAL VIDEO CAMERA

Optional Lenses

Wide Conversion Lens
GL-V0752



Tele Conversion Lens
GL-V1452



Info-Shoe for optional attachments



Auto Light



Video Flash



Stereo Zoom Microphone

Exclusive high-speed printing — GV-SP2 Digital System Printer

The GR-DV2000/1800 has a special connector for rapid image transfer to the optionally available GV-SP2 Digital System Printer. In addition to borderless print capability, the GV-SP2's high-resolution 310-dpi head enables to produce natural, breathtaking full-colour printouts.



Major features

- ❑ Borderless photo-size (100mm x 150mm) print
- ❑ 310-dpi high-resolution image
- ❑ Full-colour dye-sublimation system
- ❑ Pre-selected automatic printing with DPOF compatibility
- ❑ USB terminal for computer connectivity
- ❑ Dimensions (W x H x D): 262 x 79 x 254mm
- ❑ Weight: 2.2kg

A variety of print styles

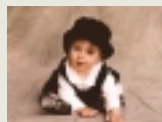

Black & White/
Sepia

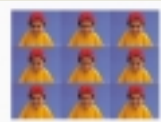

Multiscreen



Templates

Borderless



Calendar



All screen images are simulated

Best balance of mobility, quality and creativity — compact digital imaging companion

With extended PC connectivity and instant multimedia production capability, these slim, flat-design cameras offer a unique balance of quality, mobility and creativity. Superior picture quality, sophisticated shooting features, and more make it ideal for mobile video enjoyment today and the future.



● USB Terminal

For easier and even more convenient data transfer capability, the USB terminal is provided for fast, plug-and-play data downloading from the SD Memory Card/MultiMediaCard to a compatible PC. Since the USB Mass Storage Class support is provided, just hook up the camera via cable and it will appear on your computer screen as a drive unit.



**USB
Terminal**



● HG Digital Stills (XGA/VGA)

The built-in HG digital still camera can capture crystal-clear still images for output in either XGA mode or VGA mode. Based on a combination of 800K-pixel CCD and mechanical shutter system, the HG Digital Still function is able to capture full frame stills offering 1.5 times the vertical resolution of conventional field stills. By emulating the operation of a progressive-scan CCD, HG Digital Still enables moving subjects to be captured for non-jittery high quality stills.

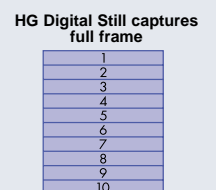
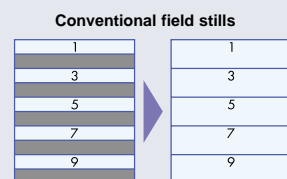

Whereas conventional field stills capture only half the scanning lines and artificially double them, HG Digital Stills capture a full frame with all 625 scanning lines, resulting in 420 lines of vertical resolution.

FEATURE LISTS

GR-DVX88

High-Band Digital Video Camera

- ❑ 520 lines of horizontal resolution with Super High-Band Processor
- ❑ Built-in HG digital still camera (XGA/VGA)
- ❑ MPEG4 Video Clips for Email
- ❑ Digital Sound Effects (MP3)
- ❑ SD Memory Card slot with MultiMediaCard compatibility
- ❑ USB high-speed interface
- ❑ DV input/output terminal
- ❑ 10x optical/200x digital zoom with spline interpolation
- ❑ Digital NightScope for extreme low-light shooting
- ❑ 2.5" high-resolution colour LCD monitor
- ❑ Auto Flash
- ❑ Dimensions (W x H x D): 51 x 120 x 97mm
- ❑ Weight: 500g without battery and tape; 575g with battery and tape

GR-DVX77

High-Band Digital Video Camera

The GR-DVX77 comes with all the features the GR-DVX88 has except for DV (i.LINK) input capability.

GR-DVX44

High-Band Digital Video Camera

- ❑ 520 lines of horizontal resolution with Super High-Band Processor
- ❑ Direct PC connection with DV (i.LINK) output and PC (serial port) terminal
- ❑ 10x optical/200x digital zoom with spline interpolation
- ❑ Digital NightScope for extreme low-light shooting
- ❑ 2.5" high-resolution colour LCD monitor
- ❑ Dimensions (W x H x D): 51 x 120 x 97mm
- ❑ Weight: 470g without battery and tape; 545g with battery and tape



GR-DVX44
HIGH-BAND DIGITAL VIDEO CAMERA



GR-DVX88/DVX77
HIGH-BAND DIGITAL VIDEO CAMERA

SD Memory Card/MultiMediaCard Compatibility

The removable MultiMediaCard lets you easily transfer image and sound data to and from a PC. Just remove the card and load it into the optional adapter or card reader — the stored data can be dragged and dropped on your PC just like any other file. And since the card slot is SD-ready, future compatibility with forthcoming storage formats is assured.



SD Memory Card



MultiMediaCard



TM

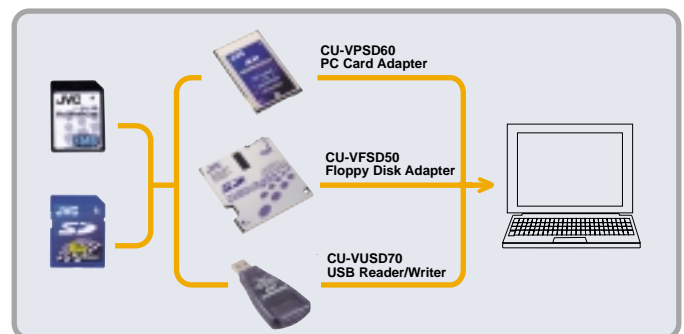

All screen images are simulated

A versatile lineup to meet any requirement —

experience MiniDV performance and versatility

Advanced performance is fundamental to all of our MiniDV digital video cameras. No matter which model you choose, you'll always get all the advantages and quality of the MiniDV format, including multimedia versatility, in an extremely easy-to-use package. Point-and-shoot controls, built-in digital still camera with USB interface,* and Digital NightScope for night scene shooting make JVC MiniDV the ideal way to begin your exploration of digital video.

*Availability differs by model.



Built-in Digital Still Camera Facility

In addition to high-quality motion video, some models also feature a built-in digital still camera to capture digital still pictures. It takes VGA (640 x 480 pixels) size digital stills and stores them on the provided MultiMediaCard. You can choose image quality between Fine and Standard depending on your needs.



Digital NightScope For Extreme Low-Light Shooting

With enhanced low-light sensitivity, JVC's exclusive Digital NightScope function allows you to capture clear, bright images at night without loss of colour associated with other night-shooting systems. Without relying on infrared rays as do similar systems, Digital NightScope uses the camera's normal optical system. As a result, the image you shoot is always in colour, and there's no limit on shooting range.

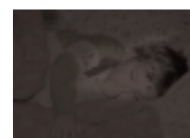

Digital NightScope
off



Digital NightScope
on

Simulated pictures



DV terminal For Digital-To-Digital Transfer

All models of DVL series are provided with a DV terminal* (i.LINK: IEEE 1394 compliant) for fast, lossless digital transfer to a computer, as well as for dubbing to another DV unit in native DV format.

*Input and output for GR-DV557/357/157, output only for GR-DVL555/450/355/150

PC (Serial) Terminal For Easy Still Image Capture

For models not equipped with digital still camera facility, there's a serial terminal for direct connection to PCs with serial ports (RS-232C), enabling you to take advantage of computer-controlled still image capture using the provided JLIP software without installing an additional board.

FEATURE LISTS

All models are equipped with the following features:

- 520 lines of horizontal resolution with Super High-Band Processor
- DV terminal
- 10x optical/300x digital zoom with spline interpolation
- Digital NightScope for extreme low-light shooting
- Snapshot mode
- EasyEdit with multi-brand remote control
- Built-in auto light

GR-DVL557/555

High-Band Digital Video Camera

- Built-in digital still camera for high-quality digital stills
- SD Memory Card slot with MultiMediaCard compatibility
- USB high-speed interface
- DV input/output (GR-DVL557), DV output (GR-DVL555)
- Analogue input (GR-DVL557)
- Software package for image processing and editing
- 3.5" high-resolution colour LCD monitor
- Dimensions (W x H x D): 83 x 97 x 188mm
- Weight: 610g without battery and tape, 690g with battery and tape

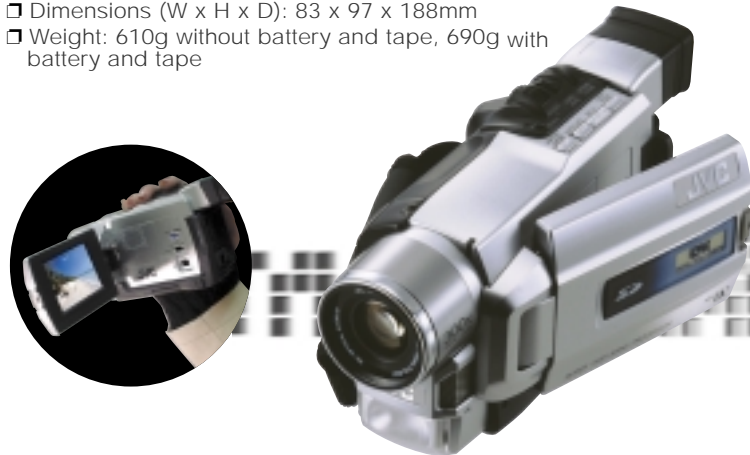

GR-DVL450

High-Band Digital Video Camera

- DV output
- Digital Still Out (serial port) terminal
- Software package for image processing and editing
- 3.5" high-resolution colour LCD monitor
- Dimensions (W x H x D): 83 x 97 x 188mm
- Weight: 610g without battery and tape, 690g with battery and tape



GR-DVL357/355

High-Band Digital Video Camera

- Built-in digital still camera for high-quality digital stills
- SD Memory Card slot with MultiMediaCard compatibility
- USB high-speed interface
- DV input/output (GR-DVL357), DV output (GR-DVL355)
- Software package for image processing and editing
- 2.5" high-resolution colour LCD monitor
- Dimensions (W x H x D): 83 x 97 x 188mm
- Weight: 590g without battery and tape, 670g with battery and tape



GR-DVL157/150

High-Band Digital Video Camera

- DV input/output (GR-DVL157), DV output (GR-DVL150)
- Digital Still Out (serial port) terminal
- Software package for image processing and editing (GR-DVL157)
- 2.5" high-resolution colour LCD monitor
- Dimensions (W x H x D): 83 x 97 x 188mm
- Weight: 590g without battery and tape, 670g with battery and tape



HS-V16KIT JLIP Capture Pack — Make the most of your MiniDV camcorder

For models that don't come with the software, an optional connection kit is available. It includes the essential accessories for image capturing and video-to-video editing with your computer. Included items: PC connection cable, JLIP Video Capture, JLIP Video Producer and Presto! Series software.



GV-DT3 Digital Printer — Direct connection for high-quality printouts

- High-quality picture (306 dpi) with 16.77 million colours
- Dye Sublimation Printing system for superior quality images
- DV input terminal (i.LINK) for digital-to-digital printing
- Infrared data transfer (IrTran-P) for wireless printing with a compatible equipment
- Video/S-video input for printing directly from camcorders and VCRs
- Serial port for direct printout from PC/capture of image to PC
- Bundled software and cables for image filing, graphics processing and printing
- Dimensions (W x H x D): 213 x 107 x 213mm
- Weight: 2.3kg (with paper tray)



The software you need to produce the multimedia you want

From simple photo albums to sophisticated digital video productions complete with special effects and titles, these versatile applications give you all the tools you need to create multimedia products you'll be proud of.



● JLIP Software: For still image capture and pro-style video editing

JVC's JLIP software bundled with some digital video cameras enables computer-controlled still image capture and linear video editing.

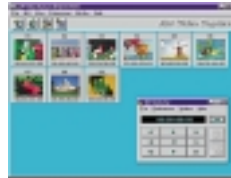

JLIP Video Capture

Enables digital-to-digital capture of still images from DV recordings to a PC as BMP or JPEG data. Interval Capture (with timecode management) allows unattended automatic capture of images.



JLIP Video Producer

Lets you use your PC as a controller for linear video editing of up to 99 segments at a time. Drop in an array of digital special effects and generate as many first-generation high-quality tapes as needed.

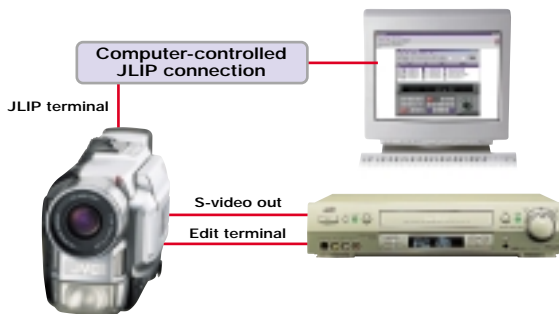

Choose
the order of scenes and special effects

Program
up to 99 segments

Automatic
computer-controlled editing begins with the touch of a button

Video Echo Shutter Wipe Sepia Corner Wipe



JLIP Interface

JLIP (Joint Level Interface Protocol) is a communications protocol developed by JVC to allow multimedia products with J-terminals to communicate. JLIP enables centralised bi-directional control of compatible AV equipment from any PC with a standard serial port and running Windows®, for streamlined video editing and image capture with JLIP software

● Presto! Series: All the software you need for quality image editing

The Presto! software bundled with most models is all you need for storing, polishing and editing your best shots.



Presto! Mr.Photo

Lets you create customised catalogues of still images as well as letting you drag-and-drop images for printing, emailing or creating HTML slideshows.

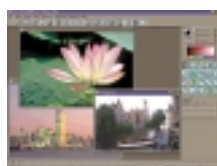

Presto! ImageFolio

Ideal for pro-style retouching with multi-layer mask support, as well as special effects such as shadowing and embossing.

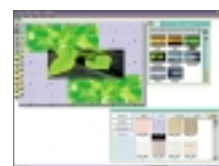

Presto! PhotoAlbum

Simplifies the creation of digital photo albums with several album and templates. You can easily convert these albums into HTML for uploading to the web.

● USB Driver

For models equipped with a USB terminal, a USB driver is also provided for easy plug-and-play data downloading to your computer.

● Software Availability For Each Model

Item	Model	GR-DVP3 GR-DVP1	GR-DV2000 GR-DV1800	GR-DVX88 GR-DVX77	GR-DVX44	GR-DVL557 GR-DVL555	GR-DVL450	GR-DVL357 GR-DVL355	GR-DVL157	GR-DVL150	HS-V16KIT
JLIP Video Capture		—	—	—	●	—	●	—	●	—	●
JLIP Video Producer		—	—	—	●	—	●	—	●	—	●
Presto! Mr. Photo		●	●	●	●	●	●	●	●	—	●
Presto! PhotoAlbum		●	●	●	●	●	●	●	●	—	●
Presto! ImageFolio		●	●	●	●	●	●	●	●	—	●
USB Driver		●	●	●	—	●	—	●	—	—	—

Note: For system requirements information, please refer to the back cover.

Accessorise your camera with these versatile options

Your camera comes equipped with everything you need to get started in the world of multimedia. But when you're ready to start exploring more options, JVC offers a variety of accessories that will help you make the most of your camera's potential.



Power Supply



* Connection cable (VC-VBN856) is included in VU-V840KBC/V856KBC only.

Lenses



Bags & Cases



Multimedia



Miscellaneous



	GR-DVP3/1	GR-DV2000/1800	GR-DVX88/77	GR-DVX44	GR-DVL557/555/357/355	GR-DVL450/157/150	GR-DVP3/1	GR-DV2000/1800	GR-DVX88/77	GR-DVX44	GR-DVL557/555/357/355	GR-DVL450/157/150
Power Supply	BN-V107/V114	●	—	—	—	—	—	●	—	—	—	—
	BN-V416/V428	—	●	—	—	●	—	—	—	—	●	●
	BN-V507/V507B/V514	—	—	●	●	—	—	—	●	●	—	—
	BT-V408K1	—	●	—	—	●	●	—	—	—	—	—
	BT-V507K1/V507BK1	—	—	●	●	—	—	—	—	—	—	—
	VU-V840KIT/V840KBC*	●	●	●*	●*	●*	●*	—	—	—	—	—
	VU-V856KIT/V856KBC*	●	●	●*	●*	●*	●*	—	—	—	—	—
AA-V40	—	●	—	—	●	●	—	—	—	—	—	
AA-V50	—	—	●	●	—	—	—	—	—	—	—	
AA-V100	●	—	—	—	—	—	—	—	—	—	—	
BH-V1	●	●	●	●	—	—	—	—	—	—	—	
Lenses	GL-V0637	—	—	—	—	—	—	—	—	—	—	—
	GL-V0752	—	●	—	—	—	—	—	—	—	—	—
	GL-V1452	—	●	—	—	—	—	—	—	—	—	—
	LN-KIT1D	—	—	●	—	—	—	—	—	—	—	—
	GL-V027FK	—	—	●	●	—	—	—	—	—	—	—
	GL-V37MC	—	—	—	—	●	●	—	—	—	—	—
		—	—	—	—	—	—	—	—	—	—	—
Bags & Cases	CB-V230	—	—	—	—	—	—	—	—	—	—	—
	CB-V240	—	—	—	—	—	—	—	—	—	●	●
	CB-V920	—	—	—	—	—	—	—	—	—	●	—
	WR-DV75	—	—	—	—	—	—	—	—	—	—	—
	WR-DVP3	—	—	—	—	—	—	—	—	—	—	—
	CB-V77	—	—	—	—	—	—	—	—	—	—	●
	CB-V753	—	—	—	—	—	—	—	—	—	—	—
CB-V747	—	—	—	—	—	—	—	—	—	—	—	
Multimedia	CU-MMC08/MMC16	●	●	●	—	—	—	—	—	—	—	—
	CU-SD016	●	●	●	—	—	—	—	—	—	—	—
	CU-VFSD50	●	●	●	—	—	—	—	—	—	—	—
	CU-VPD60	●	●	●	—	—	—	—	—	—	—	—
	CU-VUSD70	●	●	●	—	—	—	—	—	—	—	—
	VC-VDV204/VDV206	●	●	●	—	—	—	—	—	—	—	—
		—	—	—	—	—	—	—	—	—	—	—
Miscellaneous	VU-V995KIT	—	—	—	—	—	—	—	—	—	●	●
	VU-V996KIT	—	—	—	—	—	—	—	—	—	●	●
	VU-V997KIT	—	—	—	—	—	—	—	—	—	—	—
	VU-V999KIT	●	—	—	—	—	—	—	—	—	—	—
	VU-V888KIT	●	—	—	—	—	—	—	—	—	—	—
	MZ-V3/VL-F3/VL-V3	●	●	—	—	—	—	—	—	—	—	—
VU-VCKIT1D	●	●	●	●	—	—	—	—	—	—	—	

* Connection cable (VC-VBN856) is included in VU-V840KBC/V856KBC only.
Note: Certain accessories may not be available in certain areas.

Accessory compatibility chart

The ideal editing solution, JVC's dual-decks combine MiniDV and VHS in a single unit

A valuable addition to any home or professional editing suite, JVC's dual decks integrate a high-quality MiniDV deck and Super VHS deck in a single unit, bridging the gap between DV and VHS to offer unprecedented video editing, dubbing and playback flexibility. As well as allowing you to record and enjoy television programming in digital or analogue formats, these decks provide the simplest way for you to dub DV masters to VHS or S-VHS, or to edit directly from DV to VHS.



● Streamlined MiniDV playback

The integrated MiniDV deck extends the flexibility of your multimedia capabilities. Playing back your MiniDV recordings is as simple as inserting a MiniDV cassette into the MiniDV slot, for instant viewing on TV without connecting your MiniDV camera.



● Innovative JVC technologies deliver outstanding picture quality

□ MiniDV Quality & Performance

The MiniDV format shrinks the superior quality and versatility of digital video into a matchbox-size cassette. Broadcast-level quality is achieved with MiniDV's inherent high horizontal resolution (500 lines) and a colour bandwidth 3 times that of analogue video.



□ S-VHS Quality & Performance

These models incorporate JVC's DigiPure Technology to deliver top-of-the-line S-VHS quality characterised by sharp image contours and vivid colours. DigiPure Technology is, in fact, a group of advanced digital image processing technologies perfected by JVC. They include **Digital Wide TBC** (Time Base Corrector) which removes "jitter" from fluctuating video signals, to deliver stable pictures even with old tapes, for improved playback quality. The **3-Dimensional Digital Circuit** incorporating 2MB of Frame Memory is an underlying component for the following DigiPure technologies. **Precision 3-D Colour Circuit** ensures clear colour separation without bleeding, to sharpen the edges of images, especially with red colours. **Digital 3-D YNR/CNR** removes fine dust-like noise (YNR) and uneven colour noise (CNR), improving the S/N ratio by



approximately 3 dB. In addition, **Digital 3R Picture System** applies edge correction to the luminance signal to enhance detail and improve the chrominance signal's transient characteristics.

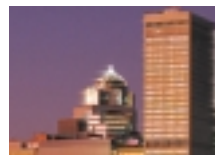

Video with fluctuating signals

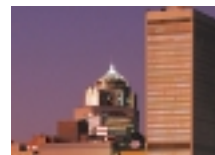

With Digital Wide TBC

Simulated pictures

● Dubbing Possibilities

□ One-touch Dubbing

By virtue of the 2-in-1 design, one-touch dubbing is enabled in either direction — from DV-to-S-VHS or S-VHS-to-DV. Push the one-touch dubbing button on the front panel for two seconds and it synchronises the two decks, rewinds both tapes to the start, and begins recording.



□ Versatile Dubbing Options

Video insert and audio dubbing is possible on either deck for increased post-recording options. For superior sound, high-quality 32KHz audio dubbing is available with the MiniDV deck. The S-VHS deck's Flying Erase Head enables insert editing of new pictures without affecting the original audio track, and with no noticeable distortion at the transition points.

□ Advanced Connectivity

Both units are equipped with a DV in/out terminal that enables direct loss-less recording to/from the MiniDV format, as

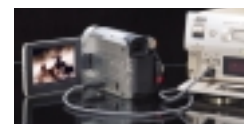

FEATURE LISTS

MiniDV/Super VHS Hi-Fi Stereo Video Cassette Recorders Both models are equipped with the following features:

- MiniDV format with PCM digital audio
- High-resolution Super VHS and Hi-Fi VHS Stereo provide exceptional image and sound quality
- DigiPure Technology
 - Digital Wide TBC
 - Digital 3-D YNR/CNR
 - Precision 3-D Colour Circuit with 2MB frame memory
 - Digital 3R Picture System
- One-touch dubbing (DV ↔ S-VHS/VHS)
- 64-Programme "EasyEdit" (DV → S-VHS/VHS)
- DV in/out terminal (i.Link, IEEE 1394 compliant) for direct digital transfer

- DV insert editing and audio dubbing (32kHz mode)
- S-VHS/VHS insert editing and audio dubbing

HR-DVS2

- Super VHS ET
- Extensive compatibility with popular NLE systems*
- Jog/shuttle on deck

*Please consult an authorised JVC dealer for further information on compatible NLE (Non-Linear Editing) systems.

HR-DVS1

- Digital special effects, wipes and fades during "EasyEdit"

HR-DVS1



HR-DVS2

Specifications

Formats:	MiniDV standard with PCM digital audio S-VHS/VHS PAL standard with Hi-Fi audio
Power requirement:	AC 220~240V, 50/60 Hz
Max. recording time:	MiniDV deck (M-DV80ME cassette) 80 min. (SP)/120 min. (LP) S-VHS deck (E-240 cassette) 240 min. (SP)/480 min. (LP)
Channel coverage:	(VHF) 47~89/104~300/302~470 MHz (UHF) 470~862 MHz
Dimensions (W x H x D):	HR-DVS2: 435 x 124 x 391mm HR-DVS1: 437 x 127 x 380mm
Weight:	HR-DVS2: 6.9kg HR-DVS1: 7.6kg

well as direct output to JVC's digital printers such as the GV-DT3. The front panel AV input terminals accept input from most analogue video sources. For more advanced editing and connectivity, the i.Link connection enables direct connection to compatible PCs for image capture.

● NLE Integration For The Editing Enthusiast

Those who expand their creativity into the realm of NLE (non-linear editing) will appreciate the extensive i.LINK (IEEE 1394) connectivity and compatibility the HR-DVS2 offers with popular NLE systems*. Since systems by various third-party manufacturers are supported, you'll be able to transfer from video to PC, or vice versa, regardless of whether the original or target video format is S-VHS/VHS or MiniDV.

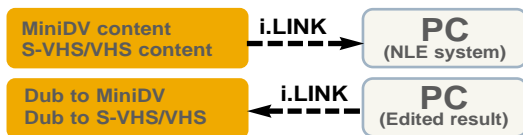

*Please consult an authorised JVC dealer for further information on compatible systems.

● 64-Programme "EasyEdit"

Dubbing from the MiniDV deck to the S-VHS deck opens up editing capabilities, without requiring a computer. Advanced Random Assemble Edit enables the "EasyEdit" of 8 programmes, each with up to 8 sets of in/out points (for a maximum 64 recorded scenes), to be combined in a final edit. Since edit programmes are saved to memory,* you can create multiple first-generation tapes on the S-VHS deck.

P1	IN	OUT	MODE	P1	DV → VHS
1	0:18:03	→ 0:18:27		P1	22:45 / 24. 12 / 1999
2	0:26:58	→ 0:28:33		P2	08:20 / 25. 12 / 1999
3	0:30:11	→ 0:33:48		P3	13:45 / 18. 11 / 1999
4	0:42:18	→ 0:44:21		P4	18:31 / 08. 08 / 1999
5	0:21:39	→ 0:22:25		P5	20:27 / 30. 12 / 1999
6	0:08:43	→ 0:11:03		P6	09:38 / 27. 10 / 1999
7	0:13:26	→ 0:15:52		P7	10:39 / 08. 03 / 1999
8	0:32:33	→ 0:37:15		P8	17:03 / 22. 11 / 1999
TO			0:20:54		
TOTAL			0:20:54		

8 Segments X 8 Programmes = 64 Total!

*Switching off the power to the deck for longer than 30 minutes erases the memory

● Digital Special Effects during "EasyEdit" (HR-DVS1)

The HR-DVS1 offers an array of professional-quality digital special effects and transitions that can be programmed on-screen using the provided remote control, to be applied during "EasyEdit". Great if you're looking for an all-in-one editing solution that doesn't require any external equipment.

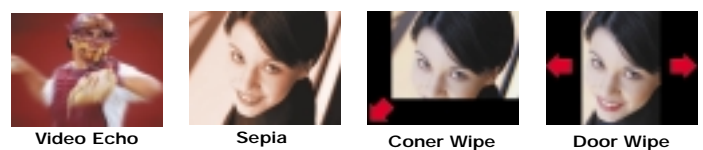

● Other High Value Features for Recording and Playback Enjoyment

The multi-brand TV/satellite-compatible remote provides control over most major brand TVs and satellite decoder units. The remote is also used for Advanced Random Assemble Editing and controlling the 10x Pinpoint Digital Zoom (HR-DVS1) when taking a closer look at your MiniDV recordings.

T-V Link compatibility offers users convenient features that include Preset Download to import preset information from the TV to the video deck, NexTVView Link for timer-based recording based on the TV's electronic programme guide. Direct Rec recording of TV programmes while you're watching them is yet another user-friendly feature.



All screen images are simulated

Feature Comparison Chart	GR-DVP3	GR-DVP1	GR-DV2000	GR-DV1800	GR-DVX88	GR-DVX77	GR-DVX44	GR-DVL557	GR-DVL555	GR-DVL450	GR-DVL357	GR-DVL355	GR-DVL157	GR-DVL150
Super High-Band Processor with 520 Lines of Horizontal Resolution	•	•	•	•	•	•	•	•	•	•	•	•	•	•
Progressive Scan CCD with Progressive Colour Filter	—	—	•	•	—	—	—	—	—	—	—	—	—	—
1.92 Megapixel Digital Stills With Pixel Shift Technology	—	—	•	•	—	—	—	—	—	—	—	—	—	—
Built-in Digital Still Camera	•HG (XGA/VGA)	•HG (XGA/VGA)	•(UXGA/ XGA/VGA)	•(UXGA/ XGA/VGA)	•HG (XGA/VGA)	•HG (XGA/VGA)	—	•(VGA)	•(VGA)	—	•(VGA)	•(VGA)	—	—
SD Memory Card/MultiMediaCard Compatibility	•	•	•	•	•	•	—	•	•	—	•	•	—	—
Provided Memory Card	SD	SD	MMC	MMC	MMC	MMC	—	MMC	MMC	—	MMC	MMC	—	—
Dual Shooting Mode	—	—	•	•	—	—	—	—	—	—	—	—	—	—
MPEG4 Video Clips For Email	•	•	—	—	•	•	—	—	—	—	—	—	—	—
Digital Sound Effects (MP3)	•	•	—	—	•	•	—	—	—	—	—	—	—	—
DV Terminal	In/Out	Out	In/Out	Out	In/Out	Out	Out	In/Out	Out	Out	In/Out	Out	In/Out	Out
Analogue Input	—	—	•	—	—	—	—	•	—	—	—	—	—	—
USB Terminal	•	•	•	•	•	•	—	•	•	—	•	•	—	—
Digital Still Output (Serial)	—	—	—	—	—	—	•	—	—	•	—	—	•	•
Zoom Ratio (Optical/Digital)	10x/100x	10x/100x	10x/300x	10x/300x	10x/200x	10x/200x	10x/200x	10x/300x	10x/300x	10x/300x	10x/300x	10x/300x	10x/300x	10x/300x
Colour LCD Monitor	2"	2"	3.5"	3.5"	2.5"	2.5"	2.5"	3.5"	3.5"	3.5"	2.5"	2.5"	2.5"	2.5"
Colour Viewfinder	•	•	•	•	•	•	•	•	•	•	—	—	—	—
Digital NightScope	•	•	—	—	•	•	•	•	•	•	•	•	•	•
Built-in Auto Flash	—	—	—	—	•	•	—	—	—	—	—	—	—	—
Built-in Auto Light	—	—	—	—	—	—	—	•	•	•	•	•	•	•
Info-Shoe	•	•	•	•	—	—	—	—	—	—	—	—	—	—
Snapshot Mode	•	•	•	•	•	•	•	•	•	•	•	•	•	•
Digital Effects & Scene Transitions	•	•	•	•	•	•	•	•	•	•	•	•	•	•
EasyEdit with Multi-Brand Remote	•	•	•	•	•	•	•	•	•	•	•	•	•	•
Provided Software*	•	•	•	•	•	•	•	•	•	•	•	•	•	—

* For available software items, refer to "Software Availability Chart" on page 12.

Software System Requirements

[For Windows®]

JLIP Video Capture/JLIP Video Producer

- Personal computer with Microsoft® Windows® 95/98/Me/2000 Professional
- One free serial port, compatible with 9600bps transmission rate, connectable to RS-232C terminal with 9-pin serial connector (Recommended compatible with UART 16550A)

Note: An optional 9-pin serial conversion adapter is required for Windows® computers using serial communication port other than standard 9-pin.

Presto! Mr.Photo/PhotoAlbum/ImageFolio

- Personal computer with Microsoft® Windows® 95/98/NT4.0/2000 Professional*
- *Also compatible with Windows® Me for GR-DVP3/DVP1

USB Driver

- Microsoft®, Windows® 98 Full Version (Not Upgrade)
- Microsoft®, windows® 98 Second Edition Full Version (Not Upgrade)
- Available USB port

If you are using Windows® 2000 Professional/Windows® Me, the information file (.inf) that is needed in order to install the standard driver that is provided with the OS is provided in this packet.

[For Macintosh®]

Presto! Mr.Photo/PhotoAlbum

- Mac OS 7.5 or later on Power Macintosh

USB Driver

- iMac™, iBook™, Power Macintosh G3/Power Mac™ G4, or PowerBook™ G3
- Mac OS 8.5.1/Mac OS 8.6/Mac OS 9.0*/Mac OS 9.1*
- Available USB port

* For Mac OS 9.0/9.1, please use the USB drive that is provided with the OS software.

Microsoft® and Windows® are either registered trademarks or trademarks of Microsoft Corporation in the United States and/or other countries. Apple, Apple logo, Macintosh® and Mac are registered trademarks of Apple Computer, Inc. in United States and/or other countries. Other trademarks are the property of their respective owners.

E. & O.E. Design & specifications are subject to change without notice. It should be noted that it may be unlawful to re-record pre-recorded tapes, records, or discs without the consent of the owner of copyright in the sound or video recording, broadcast or cable programme and in any literary, dramatic, musical, or artistic work embodied therein. SD Logo is a trademark. All brand names are trademarks, registered trademarks, or trade names of their respective holders. ShowView is a registered trademark of Gemstar Development Corporation. The ShowView system is manufactured under license from Gemstar Development Corporation. Video Plus+ and PlusCode are trademarks of Gemstar Development Corporation. Video Plus+ system is manufactured under license from Gemstar Development Corporation. Certain accessories may not be available in certain areas. All screen images and print samples in this catalogue are simulated. Copyright © 2001, Victor Company of Japan, Limited (JVC). All Rights Reserved.

JVC Europe Homepage — <http://www.jvc-europe.com/>

JVC
VICTOR COMPANY OF JAPAN, LIMITED

AVAILABLE AT



JVC
INTERNATIONAL
JAZZ
Festival

Free Manuals Download Website

<http://myh66.com>

<http://usermanuals.us>

<http://www.somanuals.com>

<http://www.4manuals.cc>

<http://www.manual-lib.com>

<http://www.404manual.com>

<http://www.luxmanual.com>

<http://aubethermostatmanual.com>

Golf course search by state

<http://golfingnear.com>

Email search by domain

<http://emailbydomain.com>

Auto manuals search

<http://auto.somanuals.com>

TV manuals search

<http://tv.somanuals.com>