

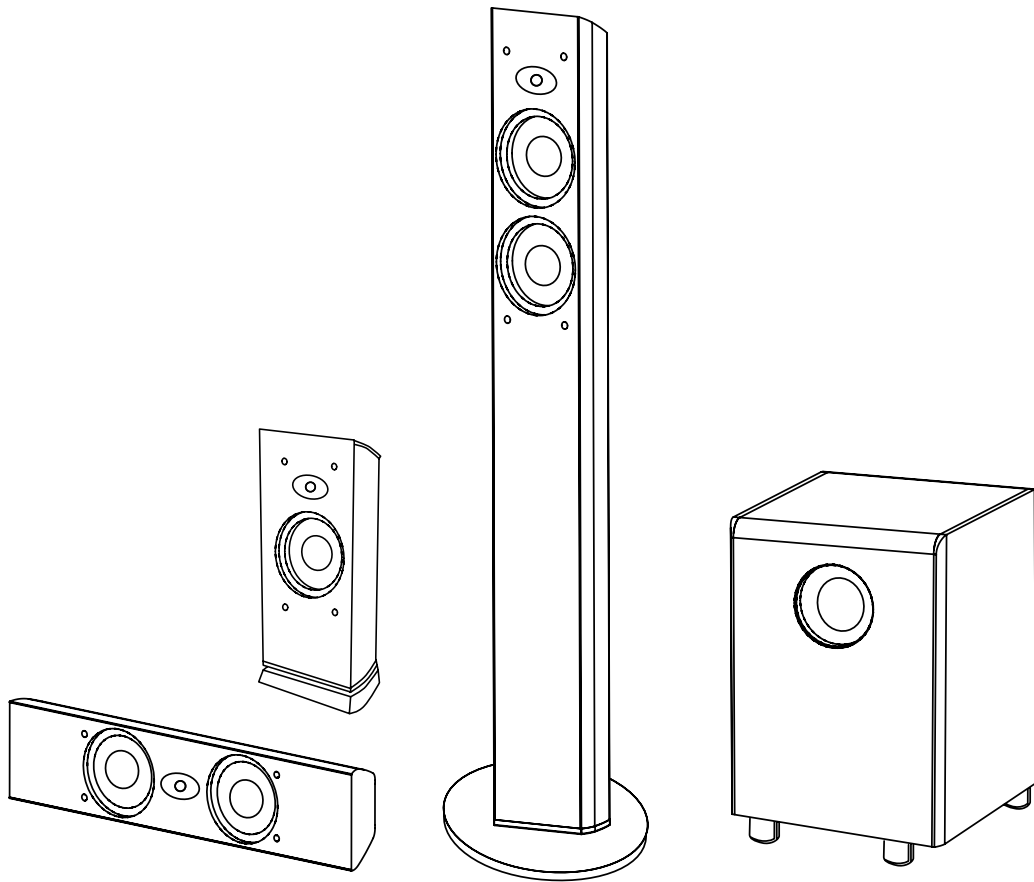



# JBL<sup>®</sup> CINEMA SOUND



CST56, CSB6, CSC56, CSS11



**OWNER'S MANUAL**

## IMPORTANT SAFETY INSTRUCTIONS

1. Read these instructions.
2. Keep these instructions.
3. Heed all warnings.
4. Follow all instructions.
5. Do not use this apparatus near water.
6. Clean only with dry cloth.
7. Do not block any ventilation openings. Install in accordance with the manufacturer's instructions.
8. Do not install near any heat sources such as radiators, heat registers, stoves, or other apparatus (including amplifiers) that produce heat.
9. Do not defeat the safety purpose of the polarized or grounding-type plug. A polarized plug has two blades with one wider than the other. A grounding-type plug has two blades and a third grounding prong. The wide blade or third prong is provided for your safety. If the provided plug does not fit into your outlet, consult an electrician for replacement of the obsolete outlet.
10. Protect the power cord from being walked on or pinched, particularly at the plugs, convenience receptacles and the point where they exit from the apparatus.
11. Only use attachments/accessories specified by the manufacturer.
12. Use only with the cart, stand, tripod, bracket or table specified by the manufacturer or sold with the apparatus. When a cart is used, use caution when moving the cart/apparatus combination to avoid injury from tip-over. 
13. Unplug this apparatus during lightning storms or when unused for long periods of time.
14. Refer all servicing to qualified service personnel. Servicing is required when the apparatus has been damaged in any way, such as: when the power supply cord or plug has become damaged, when liquid has been spilled or objects have fallen into the apparatus, when the apparatus has been exposed to rain or moisture, when the apparatus does not operate normally, or the apparatus has been dropped.
15. Do not expose this apparatus to dripping or splashing and ensure that no objects filled with liquids, such as vases, are placed on the apparatus.
16. To completely disconnect this apparatus from the AC mains, disconnect the power supply cord plug from the AC receptacle.
17. The mains plug of the power supply cord shall remain readily operable.
18. Do not expose batteries to excessive heat such as sunshine, fire or the like.

 <p>THE LIGHTNING FLASH WITH AN ARROWHEAD SYMBOL, WITHIN AN EQUILATERAL TRIANGLE, IS INTENDED TO ALERT THE USER TO THE PRESENCE OF UNINSULATED "DANGEROUS VOLTAGE" WITHIN THE PRODUCT'S ENCLOSURE THAT MAY BE OF SUFFICIENT MAGNITUDE TO CONSTITUTE A RISK OF ELECTRIC SHOCK TO PERSONS.</p>	<p><b>CAUTION</b></p> <p>RISK OF ELECTRIC SHOCK DO NOT OPEN</p> <p>WARNING: TO REDUCE THE RISK OF FIRE OR ELECTRIC SHOCK, DO NOT EXPOSE THIS APPARATUS TO RAIN OR MOISTURE.</p>	 <p>THE EXCLAMATION POINT WITHIN AN EQUILATERAL TRIANGLE IS INTENDED TO ALERT THE USER TO THE PRESENCE OF IMPORTANT OPERATING AND MAINTENANCE (SERVICING) INSTRUCTIONS IN THE LITERATURE ACCOMPANYING THE PRODUCT.</p>
<p>SEE MARKING ON BACK OF PRODUCT.</p>		

## TABLE OF CONTENTS

Thank You For Choosing This JBL® Product .....	4
Included Items.....	4
Speaker Placement .....	5
Wall-Mounting the CSC56 and CSB6 .....	6
Speaker Connections .....	7
Subwoofer Operation.....	9
Troubleshooting.....	10
Specifications.....	11

## THANK YOU FOR CHOOSING THIS JBL® PRODUCT

For more than 60 years, JBL® products have been involved in every aspect of music and film recording and reproduction, from live performances to the recordings you play in your home, car or office.

We're confident that the JBL system you have chosen will provide every note of enjoyment that you expect – and that when you think about purchasing additional audio equipment for your home, car or office, you will once again choose JBL equipment.

Please take a moment to register your product on our website at [www.jbl.com](http://www.jbl.com). Registration enables us to keep you posted on our latest advancements and helps us to understand our customers better and build products that meet their needs and expectations.

## INCLUDED ITEMS

EACH MODEL SOLD SEPARATELY

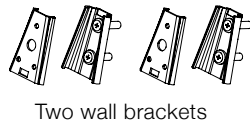
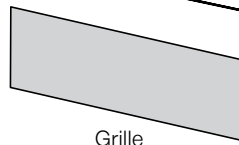
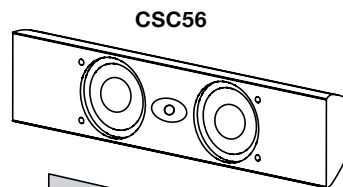

CSS11

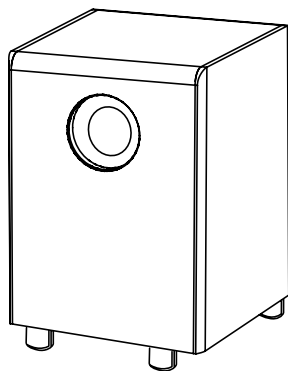

CSB6

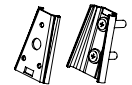
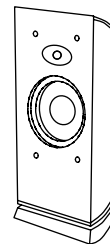

One wall bracket

CST56

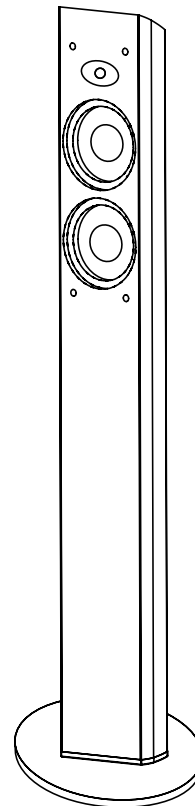

## SPEAKER PLACEMENT

### FRONT SPEAKERS

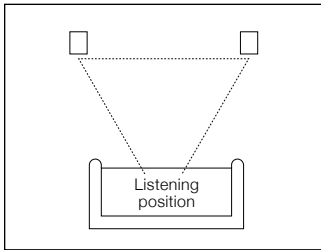

### CENTER-CHANNEL SPEAKER

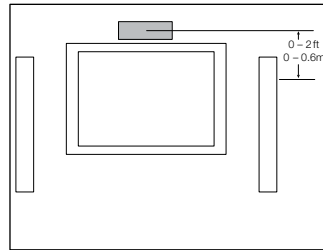

### SUBWOOFER

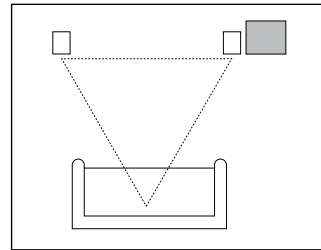

### SURROUND SPEAKERS

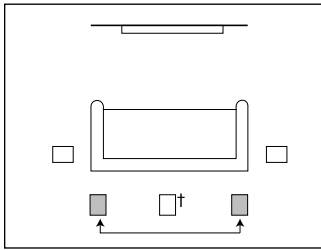

Alternate placement for surround speakers when only 5.1 channels are used; required placement for surround back speakers in 7.1-channel systems.

† Single surround back speaker may be used with 6.1-channel receivers and processors.

The front speakers should be placed the same distance from each other as they are from the listening position. The CSB6 speakers should be placed at about the same height from the floor as the listeners' ears will be, or they may be angled toward the listeners.

The center channel speaker should be placed slightly behind the front left and right speakers, and no more than 2 feet (0.6m) above or below the tweeters of the left and right speakers. It is often convenient to set the center speaker on top of the television set, as shown in the drawing.

The JBL Cinema Sound speaker system may be used in 5.1-, 6.1- or 7.1-channel applications. In 5.1-channel applications, two of the surround speakers should be placed slightly behind the listening position and, ideally, should face each other and be at a level higher than the listeners' ears. If that is not possible, they may be placed against a wall behind the listening position, facing forward. In 6.1-channel applications, two of the surround speakers should be placed in the side positions, and a single surround back speaker should be placed against the wall behind the listening position. In 7.1-channel applications, place two of the surround speakers in the side positions, and place the two surround back speakers against the back wall.

In Dolby® Digital and DTS® systems, it is best to aim all of the speakers (except the subwoofer) toward the listening position at or slightly above ear-level height. In systems where only analog surround processing (such as Dolby Pro Logic® II) is available, it may be preferable to aim the speakers straight out from the wall to obtain a more diffuse sound.

The low-frequency sound from the subwoofer radiates in all directions, and this speaker may be placed in a convenient location in the room. However, bass reproduction will be maximized when the subwoofer is placed in a corner along the same wall as the front speakers. Experiment with subwoofer placement by temporarily placing the subwoofer in the listening position and moving around the room until the bass reproduction sounds best. Place the subwoofer in that location.

## WALL-MOUNTING THE CSC56 AND CSB6

The CSC56 center channel and the CSB6 are designed to be mounted on the wall. There are two (2) fixed-mount wall brackets provided for the CSC56, and one for the CSB6. Each speaker bracket will require up to three 1-1/2" #10 wood screws; each screw should be fastened to a wall stud. If a wall stud is unavailable, install an anchor appropriate for a 1-1/2" #10 screw.

*NOTE: The customer is responsible for the correct selection and use of mounting hardware (available through hardware stores) to ensure the proper and safe wall-mounting of the speakers.*

**Step 1:** Using the included mounting template (CSC56 only) or the bracket back plate (CSB6 only), mark the positions on the wall where you would like to place the mounting screws.

**Step 2:** Attach the back plate(s) of the brackets to the wall using three screws (not included).

**Step 3:** Attach the front plate(s) (with the two holes) of the bracket(s) to the CSC56 or CSB6, using the provided screws.

**Step 4:** Slide the CSC56 or CSB6 speaker with the attached bracket front plate(s) onto the back plate(s) of the bracket(s). Once positioned properly, the speaker should slide down slightly and become secure.

To remove the speaker from the wall, simply slide the speaker up.

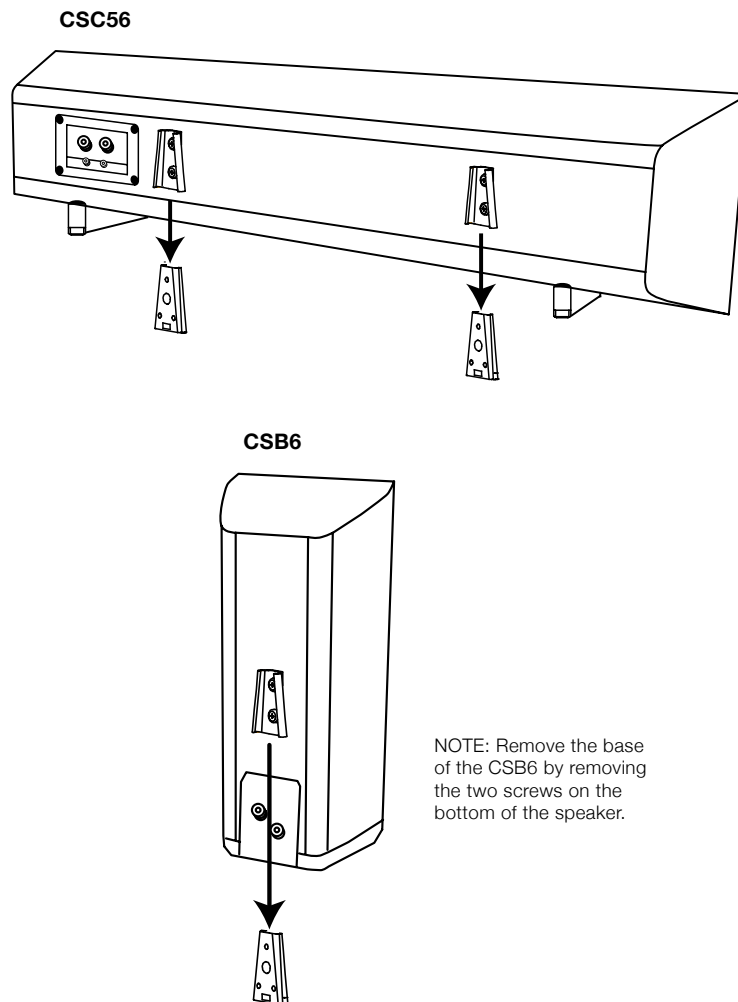

## SPEAKER CONNECTIONS

### CONNECTION TIPS

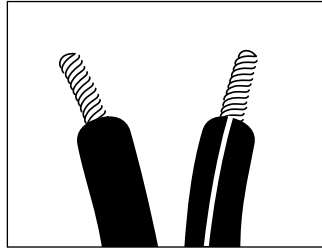

Separate and strip the ends of the speaker wire as shown. Speakers and other electronic components have corresponding (+) and (-) terminals. Most manufacturers of speakers and electronics, including JBL electronics, use red to denote the (+) terminal and black to denote the (-) terminal.

The (+) lead of the speaker wire is noted with a stripe. It is important to connect both speakers identically: (+) on the speaker to (+) on the amplifier and (-) on the speaker to (-) on the amplifier. Wiring "out of phase" results in thin sound, weak bass and a poor stereo image.

With the advent of multichannel surround sound systems, it is equally important to connect all of the speakers in your system with the correct polarity in order to preserve the proper ambience and directionality of the sound.

### CST56

To provide a neater installation, the CST56 allows you to insert the speaker wires through holes in the base. Simply separate and strip the wires as described above, loosen the terminals and insert each wire into its corresponding hole in the base. Then tighten down the terminals.

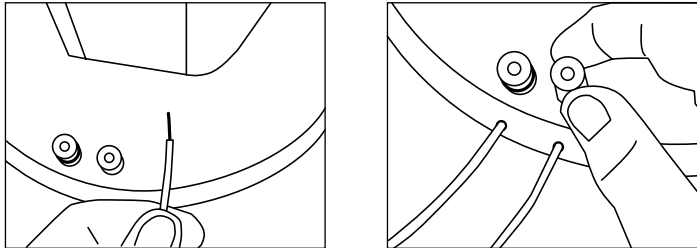

The hole in the center of each collar is intended for use with banana-type connectors. To comply with European CE certification, these holes are blocked with plastic inserts at the point of manufacture. To use banana-type connectors requires the removal of the inserts.

### CSB6, CSC56

To use the binding-post speaker terminals, unscrew the colored collar until the pass-through hole in the center post is visible under the collar. Insert the bare end of the wire through this hole; then screw the collar down until the connection is tight. The hole in the center of each collar is intended for use with banana-type connectors. To comply with European CE certification, these holes are blocked with plastic inserts at the point of manufacture. To use banana-type connectors requires the removal of the inserts.

## SPEAKER CONNECTIONS

### DOLBY® DIGITAL OR DTS® (OR OTHER DIGITAL SURROUND MODE) CONNECTION

Use this installation method for Dolby Digital, DTS or other digital surround processors:

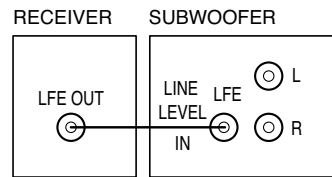

Use the line-level input jack marked “LFE” for the Low-Frequency Effects channel. Connect this jack to the LFE output or subwoofer output on your receiver or amplifier. Connect each speaker to the corresponding speaker terminals on your receiver or amplifier.

Make sure that you have configured your surround-sound processor for “Subwoofer On.” Also, configure your receiver for 5.1-, 6.1- or 7.1-channel operation as appropriate. The front left, front right, center and back speakers should all be set to “Small.” If your receiver allows you to set the crossover frequency between the subwoofer and the main speakers, select 100Hz or the setting that is the closest frequency below it.

### DOLBY PRO LOGIC® (NON-DIGITAL) – LINE LEVEL

Use this installation method for Dolby Pro Logic® applications (not Dolby Digital, DTS or other digital processing), where the receiver/processor is equipped with a subwoofer output or a volume-controlled preamp (line-) level output:

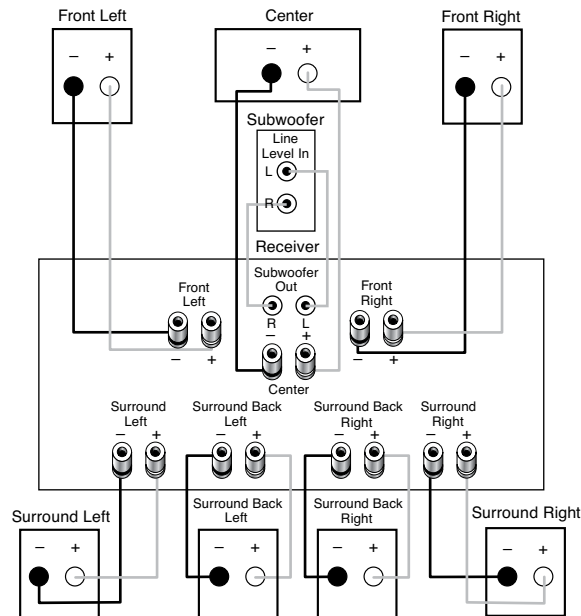

Use RCA-type cables to connect the line-level subwoofer outputs on your receiver or amplifier to the line-level inputs on the subwoofer. **IMPORTANT:** Do not use the LFE input on the subwoofer with Dolby Pro Logic processors.

**NOTE:** If your receiver or amplifier has only one subwoofer output jack, then you will need to use a Y-connector (not included). Plug the male end of the Y-connector into your receiver or amplifier's subwoofer output jack, and connect each of the two female ends to separate RCA-type interconnects. Finally, plug the RCA-type interconnects into the line-level inputs on the subwoofer.

Connect each speaker to the corresponding speaker terminals on your receiver or amplifier. Make sure your receiver or processor is correctly configured to indicate that the subwoofer is “On.”



## SUBWOOFER OPERATION

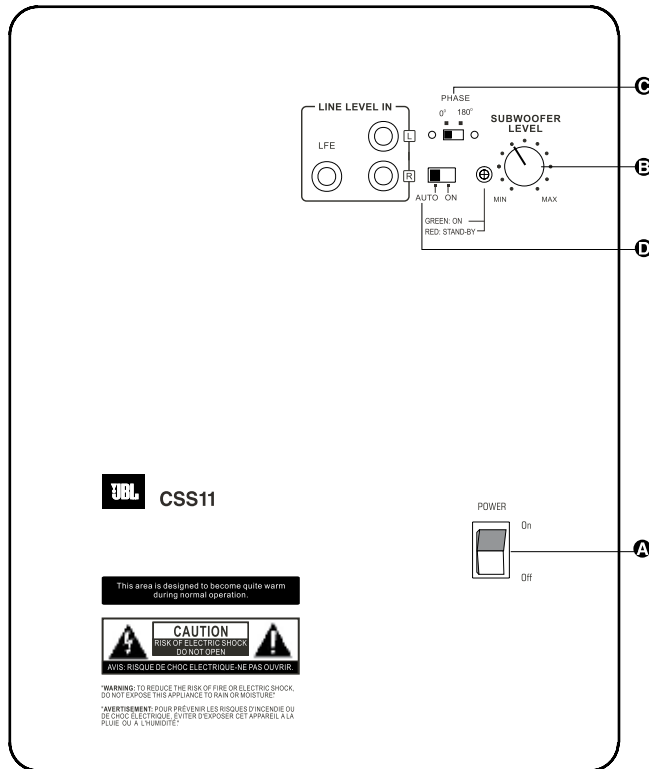

Press the Master Power switch (marked “Power” **A**) to the On position to use the subwoofer. The CSS11 subwoofer will automatically turn on or go into Standby (sleep) mode as described below. When your receiver or amplifier is off, or is not sending program material to the subwoofer, the subwoofer will be in standby mode (the LED on the front of the CSS11 will be red). When the subwoofer senses an audio signal, it will automatically turn on (the LED will be green). If the subwoofer does not sense a signal after approximately 20 minutes, it will automatically go into Standby mode.

If you will be away from home for an extended period of time, or if the subwoofer will not be used, switch the Master Power switch **A** to the Off position by pressing it until it pops out.

## VOLUME

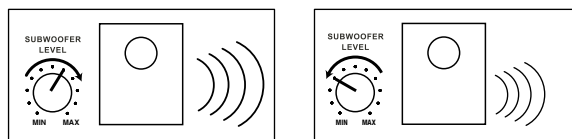

Volume may be adjusted using the Subwoofer Level control **B**, as shown.

## PHASE

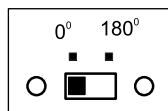

The Phase control determines whether the subwoofer’s pistonlike action moves in and out in phase with the main speakers or opposite the main speakers. There is no correct or incorrect setting. Proper phase adjustment depends on several variables, such as subwoofer placement and listener position. Adjust the Phase switch **C** to maximize bass output at the listening position.

Remember, every system, room and listener is different. There are no right or wrong settings; this switch offers the flexibility to adjust your subwoofer to optimum performance for your specific listening conditions without moving your speakers. If at some time in the future you happen to rearrange your listening room and move your speakers, you should experiment with the phase switch in both positions and leave it in the position that maximizes bass performance.

## TROUBLESHOOTING

### PROBLEM

### SOLUTION

**If there is no sound from any of the speakers:**

- Check that receiver/amplifier is on and a source is playing.
- Check that the powered subwoofer is plugged in and is turned on (Power switch **A** pushed in).
- Check all wires and connections between receiver/amplifier and speakers. Make sure all wires are connected. Make sure none of the speaker wires are frayed, cut, punctured or touching each other.
- Review proper operation of your receiver/amplifier.

**If there is no sound coming from one speaker:**

- Check the Balance control on your receiver/amplifier.
- Check all wires and connections between receiver/amplifier and speaker. Make sure all wires are connected. Make sure none of the speaker wires are frayed, cut, punctured or touching each other.
- In Dolby Digital or DTS modes, make sure that the receiver/amplifier is configured so that the speaker in question is enabled.
- Turn off all electronics, and switch the speaker in question with one of the other speakers that is working correctly. Turn everything back on, and determine whether the problem has followed the speaker or has remained in the same channel. If the problem is in the same channel, the source of the problem is most likely with your receiver or amplifier, and you should consult the owner's manual for that product for further information. If the problem has followed the speaker, consult your dealer for further assistance or, if that is not possible, visit [www.jbl.com](http://www.jbl.com).

**If there is no sound from the center speaker:**

- Check all wires and connections between receiver/amplifier and speaker. Make sure all wires are connected. Make sure none of the speaker wires are frayed, cut, punctured or touching each other.
- If your receiver/processor is set in Dolby Pro Logic mode, make sure the center speaker is not in phantom mode.
- If your receiver/processor is set in one of the Dolby Digital or DTS modes, make sure the receiver/processor is configured so that the center speaker is enabled.

**If the system plays at low volumes but shuts off as volume is increased:**

- Check all wires and connections between receiver/processor and speakers. Make sure all wires are connected. Make sure none of the speaker wires are frayed, cut, punctured or touching each other.
- If more than one pair of main speakers is being used, check the minimum impedance requirements of your receiver/amplifier.

**If there is low (or no) bass output:**

- Make sure the connections to the left and right speaker inputs have the correct polarity (+ and -).
- Make sure the subwoofer is plugged into an active electrical outlet and is turned on (Power switch **A** pushed in).
- In Dolby Digital or DTS modes, make sure your receiver/processor is configured so that the subwoofer and LFE output are enabled.
- Switch the Phase switch **C** to the opposite position, and select the position that results in the most pleasing bass response.

**If there is no sound from the surround speakers:**

- Check all wires and connections between receiver/processor and speakers. Make sure all wires are connected. Make sure none of the speaker wires are frayed, cut, punctured or touching each other.
- Review the proper operation of your receiver/amplifier and its surround-sound features.
- Make sure the movie or TV show you are watching is recorded in a surround sound mode. If it is not, check to see whether your receiver/processor has other surround modes you may use.
- In Dolby Digital or DTS modes, make sure your receiver/processor is configured so that the surround speakers are enabled. When five satellites are in use, remember to configure your receiver or processor for 6.1-channel operation, and when six satellites are in use, configure your receiver or processor for 7.1 channels.
- Review the operation of your DVD player and the jacket of your DVD to make sure that the DVD features the desired Dolby Digital or DTS mode, and that you have properly selected that mode using both the DVD player's menu and the DVD disc's menu.

## SPECIFICATIONS

### SYSTEM

Frequency response: 27Hz – 30kHz (–6dB)

	<b>CST56</b>	<b>CSB6</b>	<b>CSC56</b>
Maximum recommended amplifier power:	150W*	125W*	150W*
Power handling:	50W continuous/300W peak	40W continuous/300W peak	50W continuous/300W peak
Frequency response:	55Hz – 30kHz (–6dB)	60Hz – 30kHz (–6dB)	55Hz – 30kHz (–6dB)
Nominal impedance:	8 ohms	8 ohms	8 ohms
Sensitivity:	90dB @ 1 watt/1 meter	88dB @ 1 watt/1 meter	90dB @ 1 watt/1 meter
Tweeter:	3/4" (19mm) titanium-laminate dome, video-shielded	3/4" (19mm) titanium-laminate dome, video-shielded	3/4" (19mm) titanium-laminate dome, video-shielded
Woofers:	Dual 5" (130mm) transducers with PolyPlas™ cones, neodymium magnets and HeatScape™ motor structure, video-shielded	5" (130mm) transducer with PolyPlas cone, neodymium magnet and HeatScape motor structure, video-shielded	Dual 5" (130mm) transducers with PolyPlas cones, neodymium magnets and HeatScape motor structure, video-shielded
Dimensions (H x W x D):	46" x 11-1/4" x 11-1/4" (1168mm x 286mm x 286mm) (including base and grille)	Including base and grille: 14-5/16" x 6-1/8" x 4-9/16" (363mm x 155mm x 116mm)  Without base but with wall-mount bracket and grille: 13-5/16" x 6-1/8" x 5-1/8" (338mm x 155mm x 130mm)	6-1/4" x 26-1/4" x 4-1/4" (159mm x 667mm x 108mm) (including wall-mount bracket and grille)
Weight:	17 lb (7.7kg)	Including base and grille: 5 lb (2.3kg)  Without base and with wall-mount bracket and grille: 4.5 lb (2kg)	10 lb (4.5kg)

### CSS11

Amplifier power:	150W RMS
Frequency response:	27Hz – low-pass crossover setting at signal source
Low-frequency driver:	10" (250mm) cone and HeatScape motor structure, video-shielded
Input:	LFE preamp level
Dimensions (H x W x D) (including feet):	18-1/4" x 13-1/4" x 16" (464mm x 337mm x 406mm)
Weight:	43 lb (19.5kg)

\*The maximum recommended amplifier power rating will ensure proper system headroom to allow for occasional peaks. We do not recommend sustained operation at these maximum power levels.

Features, specifications and appearance are subject to change without notice.



Harman Consumer, Inc.  
8500 Balboa Blvd., Northridge, CA 91329 USA

© 2010 Harman International Industries, Incorporated. All rights reserved.  
JBL is a trademark of Harman International Industries, Incorporated,  
registered in the United States and/or other countries. PolyPlas and  
HeatScape are trademarks of Harman International Industries, Incorporated.  
Dolby and Pro Logic are registered trademarks of Dolby Laboratories. DTS  
is a registered trademark of Digital Theater Systems, Inc.

Part No. 950-0317-001 Rev. B

[www.jbl.com](http://www.jbl.com)

## Free Manuals Download Website

<http://myh66.com>

<http://usermanuals.us>

<http://www.somanuals.com>

<http://www.4manuals.cc>

<http://www.manual-lib.com>

<http://www.404manual.com>

<http://www.luxmanual.com>

<http://aubethermostatmanual.com>

Golf course search by state

<http://golfingnear.com>

Email search by domain

<http://emailbydomain.com>

Auto manuals search

<http://auto.somanuals.com>

TV manuals search

<http://tv.somanuals.com>