

# User Guide



5.1 Channel Home Theater System

**NS-HTIB51A**

## Contents

---

Introduction .....	1
Safety information .....	1
Ventilation .....	1
Power cord .....	1
Important safety instructions .....	1
Precautions .....	2
Receiver components .....	3
Receiver features .....	3
Package contents .....	3
Front controls .....	3
Display .....	4
Back .....	4
Subwoofer .....	4
Front, center, and surround speakers .....	5
Remote control .....	5
Setting up your home theater system .....	5
Finding a location for your home theater system .....	5
Placing your speakers .....	6
Connecting your speakers to the receiver .....	6
Connecting devices .....	7
Using rubber feet/pads for more stable speakers .....	11
Wall mounting your speakers .....	12
Installing batteries in the remote control .....	12
Using the remote control .....	12
Using the Audyssey 2EQ® room correction and speaker setup ....	12
Operating your receiver .....	14
Turning your receiver on and off .....	14
Understanding basic operations .....	14
Listening to your receiver .....	15
Listening to the radio .....	15
Presetting FM or AM stations .....	16
Using the listening modes .....	16
Using advanced setup .....	19
Using on-screen setup menus .....	19
Setting up HDMI input (HDMI Input menu) .....	19
Setting up Component input (Component menu) .....	19
Setting up Digital Audio (Digital Audio menu) .....	19
Configuring speakers (Sp Config menu) .....	20
Setting speaker distance (Sp Distance menu) .....	20
Setting the level calibration (Level Cal menu) .....	21
Adjusting the audio (Audio Adjust menu) .....	21
Naming inputs (Name Edit menu) .....	22
Setting up HDMI (HDMI Setup menu) .....	23
Changing audio settings .....	24
Selecting a digital input signal format .....	25

Controlling other components .....	26
Preprogrammed remote control codes .....	26
Using the remote control to control other components .....	26
Remote control codes .....	27
Maintaining .....	30
Troubleshooting .....	30
Specifications .....	32
Amplifier section .....	32
Video section .....	32
Tuner section .....	32
General section .....	32
Subwoofer .....	32
Front speakers .....	32
Center speaker .....	33
Surround speakers .....	33
Legal notices .....	34
Dolby TrueHD .....	34
DTS HD™ .....	34
HDMI® .....	34
AUDYSSEY 2EQ™ .....	34
One-year limited warranty .....	35



# Insignia NS-HTIB51A

## 5.1 Channel Home Theater System

### Introduction

Congratulations on your purchase of a high-quality Insignia product. Your NS-HTIB51A represents the state of the art in home theater system design and is designed for reliable and trouble-free performance.

### Safety information

<p><b>WARNING:</b> TO REDUCE THE RISK OF FIRE OR ELECTRIC SHOCK, DO NOT EXPOSE THIS APPARATUS TO RAIN OR MOISTURE.</p> <p><b>CAUTION:</b> TO REDUCE THE RISK OF ELECTRIC SHOCK, DO NOT REMOVE COVER (OR BACK). NO USER-SERVICEABLE PARTS INSIDE. REFER SERVICING TO QUALIFIED SERVICE PERSONNEL.</p>	<p><b>WARNING</b> RISK OF ELECTRIC SHOCK DO NOT OPEN</p> <p><b>AVIS</b> RISQUE DE CHOC ELECTRIQUE NE PAS OUVRIR</p>	<p>The lightning flash with arrowhead symbol, within an equilateral triangle, is intended to alert the user to the presence of uninsulated “dangerous voltage” within the product’s enclosure that may be of sufficient magnitude to constitute a risk of electric shock to persons.</p> <p>The exclamation point within an equilateral triangle is intended to alert the user to the presence of important operating and maintenance (servicing) instructions in the literature accompanying the appliance.</p>
--	---	--

### Ventilation

**Caution**

Do not block any ventilation openings. Install in accordance with these instructions.

Slots and openings in the cabinet are provided for ventilation and to ensure reliable operation of your system and to protect it from over-heating.

The openings should never be blocked by placing your system on a bed, sofa, rug, or other similar surface. This system should not be placed in a built-in installation such as a bookcase or rack unless correct ventilation is provided or these instructions have been adhered to.

### Power cord

**Caution**

We recommend that most appliances be placed upon a dedicated circuit—a single outlet circuit which powers only that appliance and has no additional outlets or branch circuits. Check the specification page of this manual for power requirements.

Do not overload wall outlets. Overloaded wall outlets, loose or damaged wall outlets, extension cords, frayed power cords, or damaged or cracked wire insulation are dangerous. Any of these conditions could result in electric shock or fire.

Periodically examine the power cord. If its appearance indicates damage or deterioration, unplug it, discontinue use of your system, and have the cord replaced with an exact replacement part by an authorized service provider.

Protect the power cord from physical or mechanical abuse, such as being twisted, kinked, pinched, closed in a door, or walked upon. Pay particular attention to plugs, wall outlets, and the point where the cord exits your receiver.

To disconnect power from the outlet, pull out the plug. When installing your system, make sure that the plug is easily accessible.

### Important safety instructions

- 1 Read these instructions.
- 2 Keep these instructions.
- 3 Heed all warnings.
- 4 Follow all instructions.
- 5 Do not use this apparatus near water.
- 6 Clean only with dry cloth.
- 7 Do not block any ventilation openings. Install in accordance with the manufacturer’s instructions.
- 8 Do not install near any heat sources such as radiators, heat registers, stoves, or other apparatus (including amplifiers) that produce heat.
- 9 Do not defeat the safety purpose of the polarized or grounding-type plug. A polarized plug has two blades with one wider than the other. A grounding type plug has two blades and a third grounding prong. The wide blade or the third prong are provided for your safety. If the provided plug does not fit into your outlet, consult an electrician for replacement of the obsolete outlet.
- 10 Protect the power cord from being walked on or pinched particularly at plugs, convenience receptacles, and the point where they exit from the apparatus.
- 11 Only use attachments/accessories specified by the manufacturer.

- 12** Use only with the cart, stand, tripod, bracket, or table specified by the manufacturer, or sold with the apparatus. When a cart is used, use caution when moving the cart/apparatus combination to avoid injury from tip-over.

PORTABLE CART WARNING



- 13** Unplug this apparatus during lightning storms or when unused for long periods of time.
- 14** Refer all servicing to qualified service personnel. Servicing is required when the apparatus has been damaged in any way, such as power-supply cord or plug is damaged, liquid has been spilled or objects have fallen into the apparatus, the apparatus has been exposed to rain or moisture, does not operate normally, or has been dropped.

**15** Damage Requiring Service

Unplug the apparatus from the wall outlet and refer servicing to qualified service personnel under the following conditions:

- When the power-supply cord or plug is damaged,
- If liquid has been spilled, or objects have fallen into the apparatus,
- If the apparatus has been exposed to rain or water,
- If the apparatus does not operate normally by following the operating instructions. Adjust only those controls that are covered by the operating instructions as an improper adjustment of other controls may result in damage and will often require extensive work by a qualified technician to restore the apparatus to its normal operation,
- If the apparatus has been dropped or damaged in any way, and
- When the apparatus exhibits a distinct change in performance this indicates a need for service.

**16** Object and Liquid Entry

- Never push objects of any kind into the apparatus through openings as they may touch dangerous voltage points or short-out parts that could result in a fire or electric shock.
- The apparatus shall not be exposed to dripping or splashing and no objects filled with liquids, such as vases shall be placed on the apparatus.
- Don't put candles or other burning objects on top of this unit.

**17** Batteries

Always consider the environmental issues and follow local regulations when disposing of batteries.

- 18** If you install the apparatus in a built-in installation, such as a bookcase or rack, ensure that there is adequate ventilation.

Leave 20 cm (8") of free space at the top and sides and 10 cm (4") at the rear. The rear edge of the shelf or board above the apparatus shall be set 10 cm (4") away from the rear panel or wall, creating a flue-like gap for warm air to escape.

## Precautions

- 1** Recording copyrighted material—Unless it's for personal use only, recording copyrighted material is illegal without the permission of the copyright holder.
- 2** AC fuse—The AC fuse inside the unit is not user-serviceable. If you cannot turn on the unit, contact your Insignia dealer.
- 3** Care—Occasionally you should dust the unit all over with a soft cloth. For stubborn stains, use a soft cloth dampened with a weak solution of mild detergent and water. Dry the unit immediately afterwards with a clean cloth. Don't use abrasive cloths, thinners, alcohol, or other chemical solvents, because they may damage the finish or remove the panel lettering.
- 4** Power

**Warning**

Before plugging in the unit for the first time, read the following section carefully.

AC outlet voltages vary from country to country.

Make sure that the voltage in your area meets the voltage requirements printed on the unit's rear panel (e.g., AC 230 V, 50 Hz or AC 120 V, 60 Hz).

The power cord plug is used to disconnect this unit from the AC power source. Make sure that the plug is readily operable (easily accessible) at all times.

Pressing ON/STANDBY to select Standby mode does not fully shutdown the unit. If you do not intend to use the unit for an extended period, remove the power cord from the AC outlet.

**5** Preventing Hearing Loss

**Caution**

Excessive sound pressure from earphones and headphones can cause hearing loss.

**6** Batteries and heat exposure

**Warning**

Batteries (battery pack or batteries installed) shall not be exposed to excessive heat as sunshine, fire or the like.

- 7** Never touch this unit with wet hands—Never handle this unit or its power cord while your hands are wet or damp. If water or any other liquid gets inside this unit, have it checked by your Insignia dealer.

**8** Handling notes

- If you need to transport this unit, use the original packaging to pack it how it was when you originally bought it.
- Do not leave rubber or plastic items on this unit for a long time, because they may leave marks on the case.
- This unit's top and rear panels may get warm after prolonged use. This is normal.

# Receiver components

## Receiver features

- 110 Watts/Channel @ 6 ohms
  - Audyssey 2EQ to Correct Room Acoustic Problems
  - Audyssey Dynamic EQ for Loudness Correction
  - Audyssey Dynamic Volume to Maintain Optimal Listening Level and Dynamic Range
  - HDMI (Ver.1.4 with Audio Return Channel, 3D), Deep-Color, x.v.Color, Lip Sync, DTS-HD Master Audio, DTS-HD High Resolution Audio, Dolby TrueHD, Dolby Digital Plus, DSD and Multi-CH PCM
  - 3 HDMI Inputs and 1 Output
  - 3 Digital Inputs (2 Optical/1 Coaxial)
  - Component Video Switching (2 Inputs/1 Output)
  - Banana Plug-Compatible Speaker Posts
  - 40 FM/AM Presets
  - H.C.P.S. (High Current Power Supply) Massive High Power Transformer
  - Direct Mode
  - 192 kHz/24-bit D/A Converters
  - Powerful and Highly Accurate 32-bit Processing DSP
  - Crossover Adjustment (40/50/60/80/100/120/150/200 Hz)
  - A/V Sync Control Function (up to 100 ms)
  - On-Screen Display via HDMI
- \* "x.v.Color" is a trademark of Sony Corporation.

## Package contents

- Receiver
- 2 Front speakers
- 1 Center speaker
- 2 Surround speakers
- 1 Subwoofer
- Remote control
- 2 x AA batteries
- FM antenna
- AM antenna
- Speaker setup microphone
- Color labels for speaker cables
- Speaker cables:
  - 11 ft. x 3
  - 26 ft. x 2
  - RCA cable 10 ft. x 1
- 20 rubber spacers for speakers

## Front controls

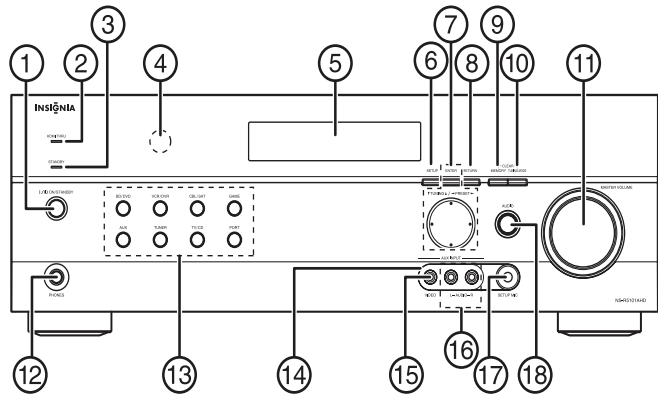

Item	Description	Function
1	<b>ON/STANDBY</b> button	Press to turn on your stereo receiver.
2	<b>HDMI THRU</b> indicator	Lights when the HDMI pass-through function is activated in standby mode.
3	<b>STANDBY</b> indicator	Lights red when your stereo receiver is in standby mode.
4	Remote control sensor	Receives the signal from the remote control.
5	Display	See "Display" on page 4 for additional information.
6	<b>SETUP</b> button	Press to open the on-screen menus.
7	<b>TUNING</b> ▲/▼ <b>PRESET</b> ◀/▶ <b>ENTER</b>	Press <b>TUNING</b> ▲/▼ to tune the radio to the next or previous station. Press <b>PRESET</b> ◀/▶ to tune the radio to the next or previous station preset. Press <b>ENTER</b> to confirm a selection.
8	<b>RETURN</b> button	In menu mode, press to return to the main menu.
9	<b>MEMORY</b> button	Press to save a radio station preset. Press with the <b>TUNING MODE</b> button to clear presets.
10	<b>TUNING MODE</b> button	Press to turn on the receiver tuning mode and listen to the radio. Press with the <b>MEMORY</b> button to clear presets.
11	<b>MASTER VOLUME</b> knob	Turn to increase or decrease the volume.
12	Headphone jack	Plug your headphones into this jack.
13	Input selector buttons	Press to select the input signal source you want.
14	Protective cap	Remove when using jack.
15	<b>AUX INPUT VIDEO</b> jack	Plug an external video source into this jack.
16	<b>AUX INPUT AUDIO L/R</b> jacks	Plug an external sound source into this jack.
17	<b>SETUP MIC</b> jack	Plug the Audyssey setup microphone into this jack. See "Using the Audyssey 2EQ® room correction and speaker setup" on page 12.
18	<b>AUDIO</b> button	Press to access audio settings. See "Changing audio settings" on page 24.

## Display

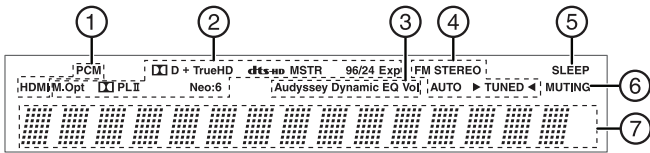

#	Indicator
1	Audio input indicator
2	Listening mode indicator
3	Audyssey indicators
4	Tuning indicators
5	SLEEP indicator
6	MUTING indicator
7	DIGITAL display

## Back

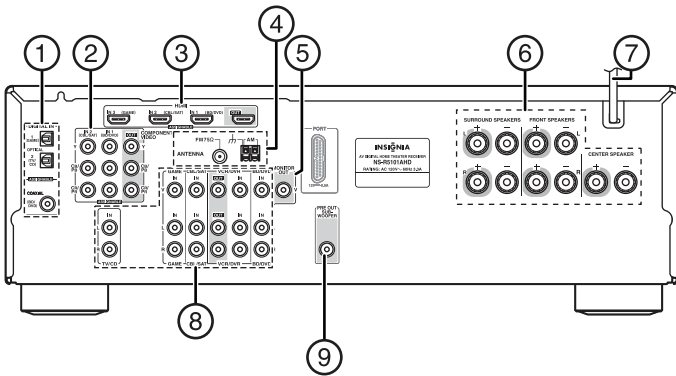

#	Description	Function
1	<b>DIGITAL IN</b> jacks	Plug the optical digital cable from a game (1) or TV/CD (2) into the upper jacks, or the coaxial digital cable from a BD/DVD into the lower jack.
2	<b>COMPONENT</b> video jacks	Plug the cables from a component video source into the #1 (BD/DVD) or #2 (CBL/SAT) jacks. Plug the cables to a component video monitor into the OUT jacks. The jacks are color coded (red, green, and blue) to correspond to the cable connectors.
3	<b>HDMI</b> jacks	Plug the HDMI signal input cable from a GAME (IN3), cable/satellite box (IN2), or a BD/DVD player (IN1). Plug the HDMI output signal cable to a TV or monitor into the OUT jack.
4	<b>ANTENNA</b> connectors	Connect a 75 ohm FM antenna to the coaxial connector or an AM loop antenna to the wire connectors.
5	<b>MONITOR OUT V</b> (Video)	Connect this jack to a TV monitor.
6	<b>FRONT SPEAKERS</b> <b>SURROUND SPEAKERS</b> <b>CENTER SPEAKER</b>	Connect the left and right surround speakers and the center speaker to these jacks.
7	AC power cord	Plug this cord into an AC power outlet.
8	<b>Composite Video</b> and <b>Audio L/R</b> jacks	Plug the composite video and audio L/R output cables from the indicated devices into these jacks. For video recording, plug the composite video and audio L/R input cables to a VCR or DVR into the OUT jacks
9	<b>SUBWOOFER</b>	Connect the subwoofer to this jack.

## Subwoofer

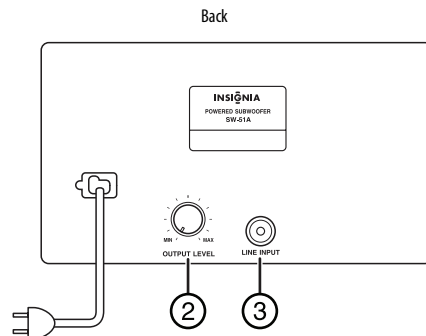
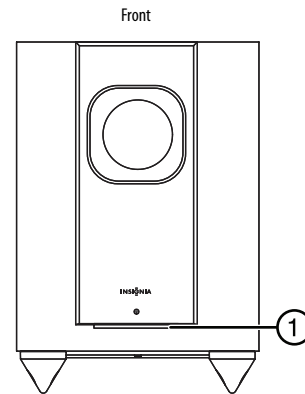

#	Description	Function
1	<b>Standby/On indicator</b>	Red: Subwoofer in standby mode Blue: Subwoofer on With the auto standby function, the subwoofer automatically turns on when an input signal is detected in standby mode. When there is no input signal, the subwoofer automatically enters standby mode. <b>Note:</b> The auto standby function turns the subwoofer on when the input signal exceeds a certain level. If the auto standby function does not work reliably, try slightly increasing or decreasing the subwoofer output level on the receiver
2	<b>OUTPUT LEVEL</b> control	This control is used to adjust the volume of the subwoofer.
3	<b>LINE INPUT</b> jack	This jack should be connected to the subwoofer pre-out on the AV receiver with the supplied RCA cable.



### Front, center, and surround speakers

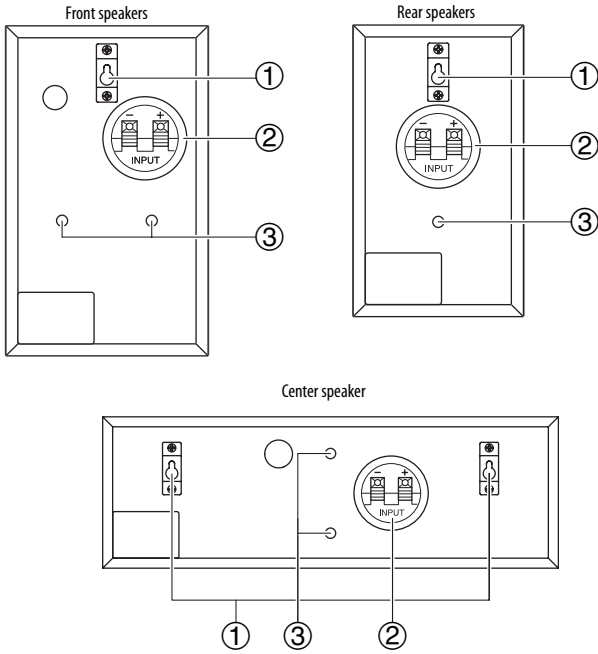

#	Description	Function
1	Keyhole slots	Used to wall-mount the speakers.
2	Speaker terminals	These push terminals are for connecting the speaker to the receiver with the supplied speaker cables.
3	Threaded Inserts	These threaded inserts are for InIt®-Home Theater Speaker Mounts NT-SWM series.

### Remote control

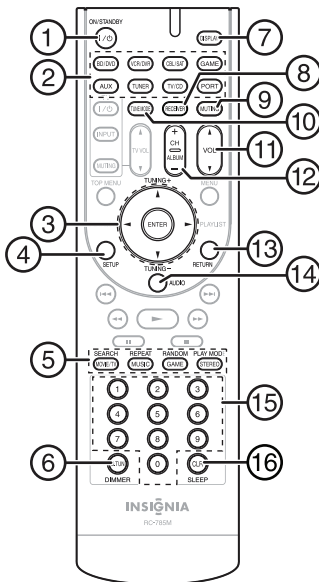

Item	Description	Function
1	ON/STANDBY button	Press to turn the power on to your receiver. Press again to go to standby mode.
2	Remote mode input selector buttons	Press to directly select your receiver input source.

Item	Description	Function
3	<b>ENTER</b> <b>TUNING+/-</b>	Press the arrow keys to navigate through the on-screen menus. Press <b>ENTER</b> to confirm a selection or setting. In tuning mode, press to tune to the next (TUNING+) or previous (TUNING-) station.
4	<b>SETUP</b> button	Press to open the on-screen menus.
5	<b>LISTENING MODE</b> buttons	Press to select the listening mode you want. See "Using the listening modes" on page 16 for additional information.
6	<b>D.TUN</b> <b>DIMMER</b>	In tuner mode, press <b>D.TUN</b> , then the number buttons to tune directly to a frequency. Press <b>DIMMER</b> to adjust the brightness of the display.
7	<b>DISPLAY</b> button	Press repeatedly to cycle through the available input source information.
8	<b>RECEIVER</b> button	Press to control the receiver.
9	<b>MUTING</b> button	Press to mute the sound output from the receiver.
10	<b>TUNE MODE</b> button	Press to toggle between auto and manual tuning modes.
11	<b>VOL</b> buttons	Press to increase or decrease the sound volume.
12	<b>CH +/-</b> buttons <b>ALBUM</b>	In tuner mode, press to go to the next or previous preset channel.
13	<b>RETURN</b> button	In menu mode, press to return to the main menu.
14	<b>AUDIO</b> button	Press to access audio settings. See "Changing audio settings" on page 24.
15	Number buttons	Press to enter a preset number or to manually tune the radio.
16	<b>SLEEP/CLR</b> button	Press repeatedly to select the sleep timer duration. In menu mode, press to clear an entry.

## Setting up your home theater system

### Finding a location for your home theater system

- Install your home theater system on a stable flat surface. Position your receiver so that it has a direct line of sight to the remote control.
- Do not expose your system to extremes of temperature or humidity.
- Avoid placing your system on a hot surface such as on top of other hot running equipment. Make sure that there is adequate ventilation to your system.

#### Caution

Do not install the receiver in a confined space such as a bookcase.

#### Caution

**Connect the AC cord only after the speakers, antenna, and all optional equipment have been connected. Never make or change any connections with the power turned on.**

## Placing your speakers

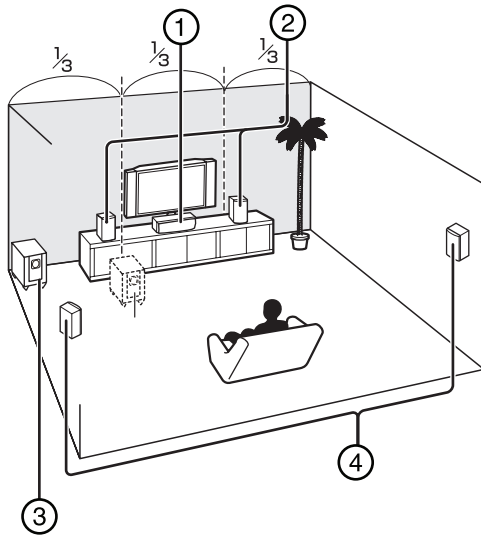

### 1 - Center speaker

This speaker enhances the front speakers, making sound movements distinct and providing a full-sound image. In movies it is used mainly for dialog. Position it close to your TV facing forward at about ear level, or at the same height as the front speakers.

### 2 - Front speakers

These provide the overall sound. Their role in a home theater system is to provide a solid anchor for the sound image. They should be positioned facing the listener at about ear level, and equidistant from the TV. Angle them inward so as to create a triangle, with the listener at the apex.

### 3 - Subwoofer

The subwoofer handles the bass sounds of the LFE (Low-Frequency Effects) channel. The volume and quality of the bass output from your subwoofer will depend on its position, the shape of your listening room, and your listening position. In general, a good bass sound can be obtained by installing the subwoofer in a front corner, or at one-third the width of the wall, as shown.

#### Tip

To find the best position for your subwoofer, while playing a movie or some music with good bass, experiment by placing your subwoofer at various positions within the room, and choose the one that provides the most satisfying results.

### 4 - Surround speakers

These speakers are used for precise sound positioning and to add realistic ambience. Position them at the sides of the listener, or slightly behind, about two to three feet (60 to 100 cm) above ear level. Ideally they should be equidistant from the listener.

### Speaker precautions

- The speaker cabinets are made out of wood and are therefore sensitive to extreme temperatures and humidity. Do not put them in locations subject to direct sunlight or in humid places, such as near an air conditioner, humidifier, bathroom, or kitchen.

- Do not put water or other liquids close to the speakers. If liquid is spilled on the speakers, they may be damaged.
- Speakers should only be placed on sturdy, flat surfaces that are free from vibration. Putting them on uneven or unstable surfaces, where they may fall and cause damage, affects the sound quality.
- The subwoofer is designed to be used in the upright vertical position only. Do not use it in the horizontal or tilted position.
- If the subwoofer is placed near a turntable, CD player, or Blu-ray Disc/DVD player, howling or slipping of the sound may occur. To prevent this, move the unit away from the turntable, CD player, or Blu-ray Disc/DVD player, or lower the subwoofer's output level.

## Connecting your speakers to the receiver

### Speaker configuration

The following table indicates the channels you should use depending on the number of speakers that you have. For 5.1-channel surround-sound playback, you need five speakers and a powered subwoofer.

Number of channels	2	3	4	5
Front speakers	X	X	X	X
Center speaker		X		X
Surround speakers			X	X

No matter how many speakers you use, a powered subwoofer is recommended for a really powerful and solid bass.

To get the best from your surround sound system, you need to set the speaker settings. You can do this automatically (see "Using the Audyssey 2EQ® room correction and speaker setup" on page 12, or manually (see "Configuring speakers (Sp Config menu)" on page 20).

### Attaching the speaker cable labels

The AV receiver's positive (+) speaker terminals are all red. (The negative (-) speaker terminals are all black.)

Speaker	Color
Front left	White
Front right	Red
Center	Green
Surround left	Blue
Surround right	Gray

The supplied speaker cable labels are also color-coded. You should attach them to the positive (+) side of each speaker cable in accordance with the table above. Then all you need to do is to match the color of each label to the corresponding speaker terminal.

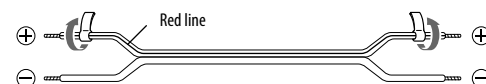

**Speaker connection precautions**

Read the following before connecting your speakers:

- You can connect speakers with an impedance of between 6 and 16 ohms. If you use speakers with a lower impedance, and use the amplifier at high volume levels for a long period of time, the built-in amp protection circuit may be activated.
- Disconnect the power cord from the wall outlet before making any connections.
- Pay close attention to speaker wiring polarity. In other words, connect positive (+) terminals only to positive (+) terminals, and negative (-) terminals only to negative (-) terminals. If you get them the wrong way around, the sound will be out of phase and will sound unnatural.
- Unnecessarily long, or very thin speaker cables may affect the sound quality and should be avoided.
- Be careful not to short the positive and negative wires. Doing so may damage the receiver.
- Make sure the metal core of the wire does not have contact with the receiver's rear panel. Doing so may damage the receiver.

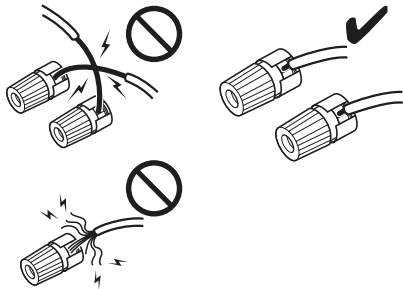

- Don't connect more than one cable to each speaker terminal. Doing so may damage the receiver.
- Don't connect one speaker to several terminals.

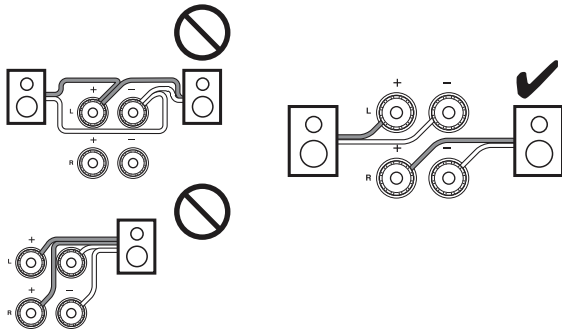

**To connect the speaker cables:**

- 1 Strip 1/2" to 5/8" (12 to 15 mm) of insulation from the ends of the speaker cables, and twist the bare wires tightly, as shown. (Supplied speaker cables are already stripped.)
- 2 Loosen the speaker terminals on the receiver and insert the speaker wires into the terminals (black wires go to the negative (-) terminals). The following illustration shows which speaker should be connected to each pair of terminals.
- 3 Tighten the terminals to secure the wire.

- 4 Press and hold the push-terminals on each speaker and insert the speaker wire, then release the push-terminal to secure the wire (black wires go to the negative (-) terminals).

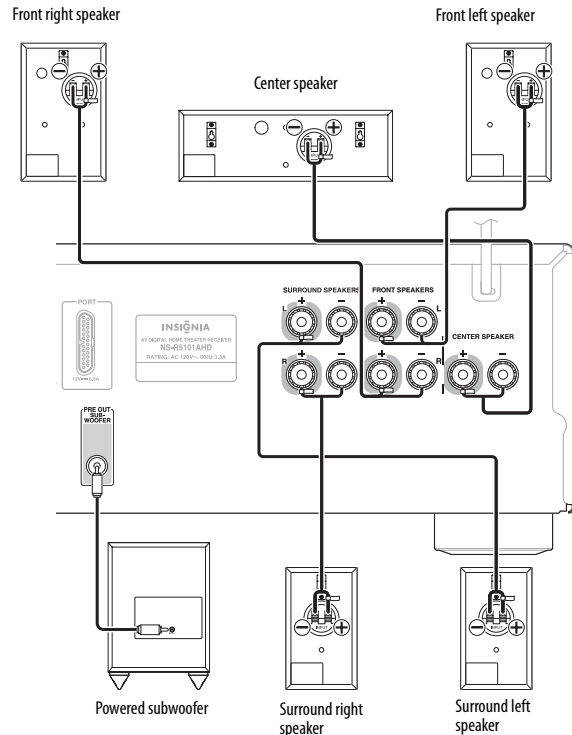

**Tips**

- If you are using banana plugs, tighten the speaker terminal before inserting the banana plug.
- Do not insert the speaker wire directly into the center hole of the speaker terminal.

**Connecting devices**

**Warning**

Do not plug the AC cord into the AC outlet until all connections are completed.

**Notes**

- Be sure to observe the color coding when connecting audio and speaker cords.
- Make connections firmly and correctly. Failure to do this can cause loss of sound, add noise to the sound, or damage your receiver.

**Connecting the antenna**

This section explains how to connect the supplied indoor FM antenna and AM loop antenna. The receiver won't pick up any radio signals without any antenna connected, so you must connect the antenna to use the tuner.

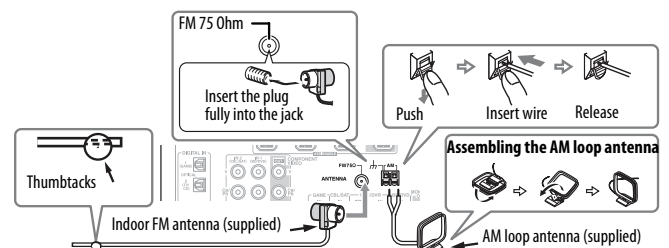

### To connect the antennas:

- 1 Connect the FM antenna to your receiver.

**Note**

If you are using an indoor FM antenna, change the position of the antenna until you get the best reception of your favorite FM stations. To improve reception, use a 75 Ω outdoor antenna instead of an indoor antenna. Disconnect the indoor antenna before replacing it with an outdoor antenna.

**Tip**

Once your receiver is ready for use, you need to tune into a radio station and position the antenna to achieve the best possible reception. If you cannot achieve good reception with the supplied indoor FM antenna, try a commercially available outdoor FM antenna instead.

- 2 Connect the AM loop antenna to the receiver.

**Notes**

Place the AM loop antenna as far as possible from the receiver, television, speaker cords, and the AC cord. Change the position of the antenna until you get the best reception of your favorite AM stations. To improve reception, use an outdoor AM antenna instead of a loop AM antenna. Disconnect the indoor antenna before replacing it with an outdoor antenna.

### Connecting audio components

#### HDMI cable

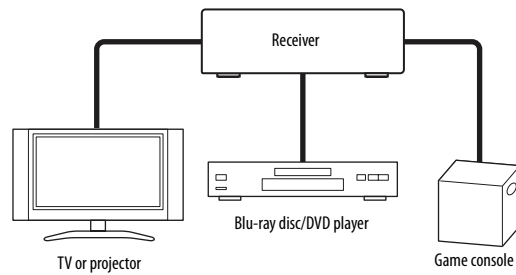

#### Other cables

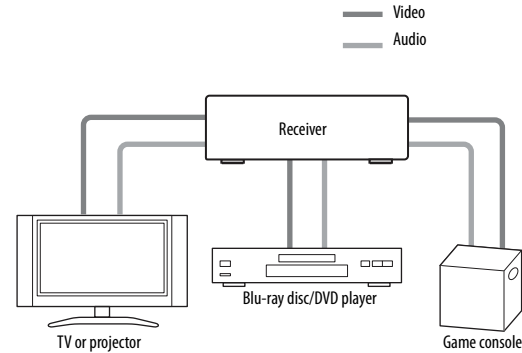

**Notes**

- Before making any AV connections, read the manuals supplied with your AV components.
- Don't connect the power cord until you've completed and double-checked all AV connections.
- Push plugs in all the way to make good connections (loose connections can cause noise or malfunctions).
- To prevent interference, keep audio and video cables away from power cords and speaker cables.

### AV cables and jacks

Signal	Cable	Jack	Description
Video and audio	HDMI	HDMI	HDMI connections can carry digital video and audio.
Video	Component video	Y Green Pb Blue Pr Red	Component video separates the luminance (Y) and color difference signals (Pr, Pb), providing the best picture quality (some TV manufacturers label their component video sockets slightly differently).
	Composite video	Y Yellow	Composite video is commonly used on TVs, VCRs, and other video equipment.
Audio	Optical digital audio	OPTICAL	Optical digital connections allow you to enjoy digital sound such as PCM* or Dolby Digital. The audio quality is the same as coaxial. <b>Note:</b> The available sampling rate for PCM input signals is 32/44.1/48/88.2/96 kHz. Even 176.4/192 kHz is effective in case of the HDMI connection.
	Coaxial digital audio	DIGITAL Orange	Coaxial digital connections allow you to enjoy digital sound such as PCM* or Dolby Digital. The audio quality is the same as optical.
	Analog audio (RCA)	L White R Red	Analog audio connections (RCA) carry analog audio.

**Notes**

- The AV receiver does not support SCART plugs.
- The AV receiver's optical digital jacks have shutter-type covers that open when an optical plug is inserted and close when it's removed. Push plugs in all the way.

**Caution**

To prevent shutter damage, hold the optical plug straight when inserting and removing.

**Deciding which connections to use**

The receiver supports several connection formats for compatibility with a wide range of AV equipment. The format you choose depends on the formats supported by your components. Use the following sections as a guide.

**Notes**

- The on-screen setup menus appear only on a TV that is connected to the HDMI OUT. If your TV is connected to the MONITOR OUT V or the COMPONENT VIDEO OUT, use the receiver's display when changing settings.
- The on-screen setup menus are displayed when there is no video input, or the video input is 480p, 576p, 720p, 1080i, or 1080p.

**Video connection formats**

Video components can be connected by using any one of the following video connection formats: composite video, component video, or HDMI (for the best picture quality).

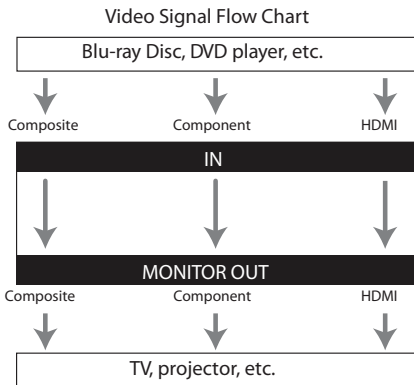

When choosing a connection format, bear in mind that the receiver does not convert between formats, so only outputs of the same format as the input will output the signal.

**Audio connection formats**

Audio components can be connected by using any of the following audio connection formats:

- Analog
- Optical
- Coaxial
- HDMI

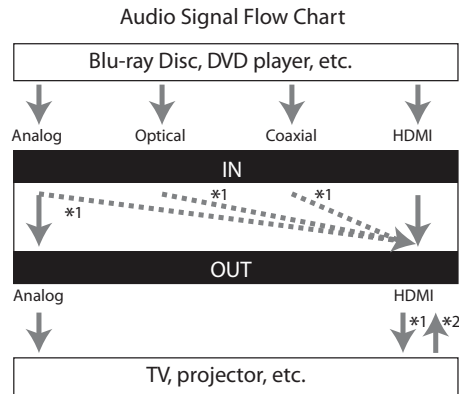

\*1 - Depends on the Audio TV Out setting.

\*2 - This setting is available when the Audio Return Ch setting is set to Auto. You must select the TV/CD input selector and your TV must support ARC function.

When choosing a connection format, note that the receiver does not convert digital input signals for analog line outputs and vice versa. For example, audio signals connected to an optical or coaxial digital input are not output by the analog VCR/DVR OUT.

If signals are present at more than one input, the inputs are selected automatically in the following order of priority:

- HDMI
- Digital
- Analog

**Connecting components with HDMI**

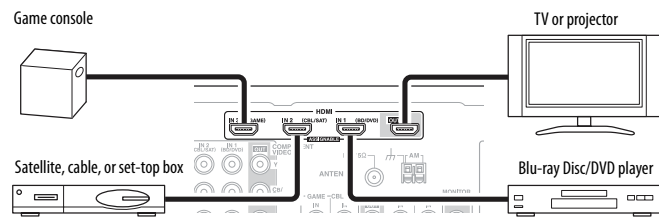

Connect your components to the appropriate jacks. The default input assignments are shown below. To change assignments, see "Setting up HDMI input (HDMI Input menu)" on page 19.

Jack	Signal	Components	Assignable	
Input	HDMI IN1	Audio/Video	Blu-ray disc/DVD player	X
	HDMI IN2		Satellite, cable, set-top box	X
	HDMI IN3		Game console	X
Output	HDMI OUT		TV or projector	

**Tip**

To listen to audio received by the HDMI IN jacks through your TV's speakers:

- Set the **TV Control** setting to **On** for a CEC-compatible TV.
- Set the **Audio TV OUT** setting to **On** when the TV is not compatible with CEC or the **TV Control** setting is **Off**.
- Set your Blu-ray Disc/DVD player's HDMI audio output setting to **PCM**.
- To listen to TV audio through the receiver, see "Connecting external components" on page 10.

**Using the audio return channel (ARC) function**

The audio return channel (ARC) function lets an HDMI-capable TV send the audio stream to the HDMI OUT jack of the receiver. To use this function, you must select the TV/CD input selector and your TV must support the ARC function.

**Connecting external components**

**Note**

The on-screen setup menus appear only on a TV that is connected to the **HDMI OUT** jack. If your TV is connected to the **MONITOR OUT V** jack or the **COMPONENT VIDEO OUT** jack, use the receiver's display when changing settings.

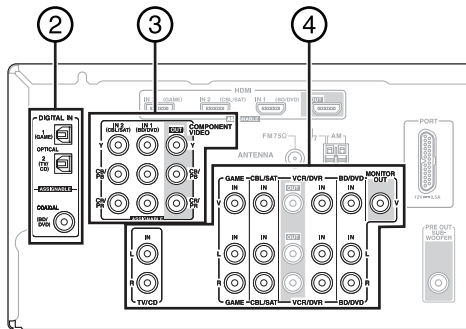
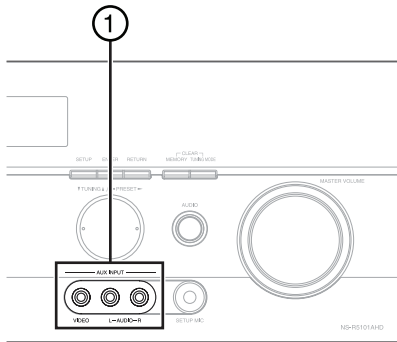

Connect your components to the appropriate jacks. The default input assignments are shown below. To change assignments, see "Setting up Component input (Component menu)" on page 19.

No.	Jack	Signal	Components	Assign.
1	AUX INPUT	VIDEO	Composite video	
		AUDIO L/R	Analog audio	
2	DIGITAL IN	OPTICAL IN 1 (GAME)	Game console	X
		IN 2 (TV/CD)	TV or CD player	X
		COAXIAL IN 1 (BD/DVD)	Blu-ray disc/DVD player	X

No.	Jack	Signal	Components	Assign.	
3	COMPONENT VIDEO	IN 1 (BD/DVD)	Component video	Blu-ray disc/DVD player	X
		IN 2 (CBL/SAT)	Satellite, cable, set-top box	X	
		OUT	TV or projector		
4	MONITOR OUT	Composite video	TV or projector		
	BD/DVD IN	Analog audio and composite video	Blu-ray disc/DVD player		
	VCR/DVR IN		VCR or DVD recorder/Digital Video recorder		
	CBL/SAT IN		Satellite, cable, set-top box		
	GAME IN		Game console		
	TV/CD IN	Analog audio	TV, CD player, turntable*, cassette tape player, MD, CD-R		

\* Connect to a turntable (MM) that has a phono preamp built-in. If your turntable (MM) does not have a built-in preamp, you will need a commercially available phono preamp. If your turntable has a moving coil (MC) type cartridge, you will need a commercially available MC head amp or MC transformer as well as a phono preamp. See your turntable's manual for details.

**Notes**

- The receiver can output audio and video signals from the **AUX INPUT** jacks to the **VCR/DVR OUT** jacks.
- With connection 2, you can enjoy Dolby Digital and DTS.
- With connection 4, if your Blu-ray Disc/DVD player has both main stereo and multichannel outputs, be sure to connect the main stereo.
- With the connections described above, you cannot record the video through the receiver. To make a connection for video recording, see the following section.

**Connecting recording components**

To record audio and video from the same source input

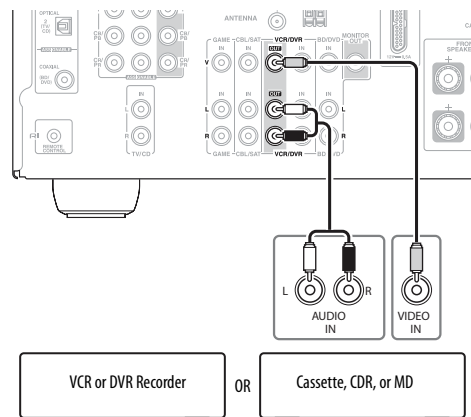



**Notes**

- The AV receiver must be turned on for recording. Recording is not possible while it's in Standby mode.
- If you want to record directly from your TV or playback VCR to the recording VCR without going through the AV receiver, connect the TV/VCR's audio and video outputs directly to the recording VCR's audio and video inputs. See the manuals supplied with your TV and VCR for details.
- Video signals connected to composite video inputs can be recorded only via composite video outputs. If your TV/VCR is connected to a composite video input, the recording VCR must be connected to a composite video output.
- The surround sound and DSP listening modes cannot be recorded.
- Copy-protected Blu-ray discs and DVDs cannot be recorded.
- Sources connected to a digital input cannot be recorded. Only analog inputs can be recorded.
- DTS signals will be recorded as noise, so don't attempt analog recording of DTS CDs or LDs.

**AV Recording**

Audio sources can be recorded to a recorder (such as a cassette deck, CDR, MD) connected to the **VCR OUT** jacks. Video sources can be recorded to a video recorder (such as a VCR or DVD recorder) connected to the **VCR/DVR Out** jack.

**To record an audio source:**

- 1 Use the input selector buttons to select the source that you want to record. You can watch the source while recording. The receiver's **MASTER VOLUME** control has no effect on recording.
- 2 Start recording on your recorder.
- 3 On the source component, start playback. If you select another input source during recording, that input source will be recorded.

**Recording Separate AV Sources**

You can record audio and video from completely separate sources, allowing you to overdub audio onto your video recordings. This function takes advantage of the fact that when an audio-only input source (TV/CD) is selected, the video input source remains unchanged.

In the following example, audio from the CD player connected to the **TV/CD IN** jack and video from the camcorder connected to the **AUX INPUT VIDEO** jack are recorded by the VCR connected to the **VCR/DVR OUT** jacks.

To record the audio from one source input and the video from another source input

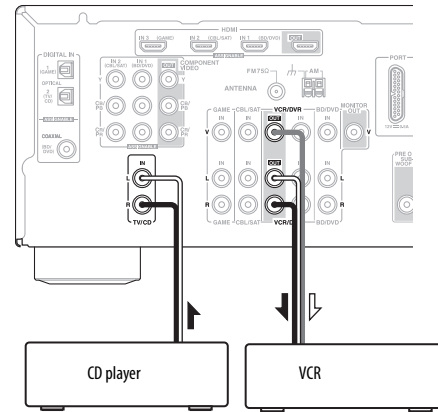
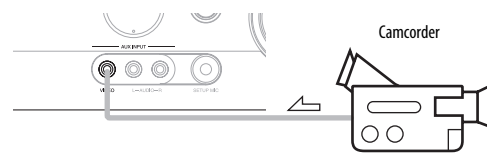

↗ : Video signal  
↖ : Audio signal

**To record separate AV sources:**

- 1 Prepare the camcorder and CD player for playback and the VCR for recording.
- 2 Press the **AUX** input selector.
- 3 Press the **TV/CD** input selector. This selects the CD player as the audio source, but leaves the camcorder as the video source.
- 4 Start recording on the VCR and start playback on the camcorder and CD player. The video from the camcorder and the audio from the CD player are recorded by the VCR.

**Connecting the power**

**To connect your receiver to power:**

- Plug the power cord into an AC outlet.

**Using rubber feet/pads for more stable speakers**

We recommend using the rubber feet (provided) to achieve the best possible sound from your speakers. The rubber feet prevent the speakers from moving, providing a more stable platform.

## Wall mounting your speakers

The speakers can easily be wall mounted by using the keyhole slots.

To mount the front or surround speakers vertically, use the keyhole slot shown to hang each speaker on a screw that is securely screwed into the wall.

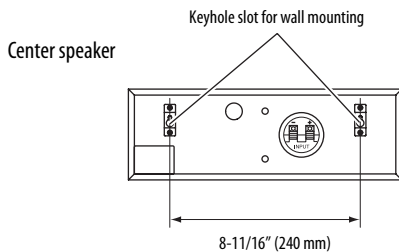
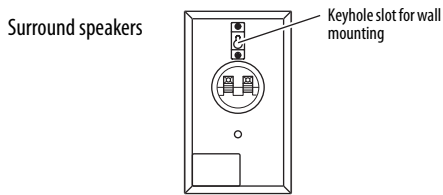
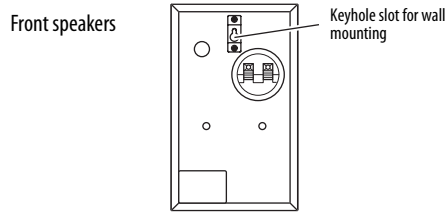

To mount the center speaker horizontally, use the two keyhole slots shown to hang each speaker on two screws that are securely screwed into the wall.

### Cautions

- A mounting screw's ability to support a speaker depends on how well it's anchored to the wall. If you have hollow walls, screw each mounting screw into a stud. If there are no studs, or the walls are solid, use suitable wall anchors.
- Use screws with a head diameter of 5/16" (9 mm) or less and a shank diameter of 1/8" (4 mm) or less. With hollow walls, use a cable/pipe detector to check for any power cables or water pipes before making any holes.
- Leave a gap of between 3/16" (5 mm) and 7/16" (10 mm) between the wall and the base of the screw head. (We recommend that you consult a home installation professional.)

## Installing batteries in the remote control

### Cautions

- If the remote control doesn't work reliably, try replacing the batteries.
- Don't mix new and old batteries or different types of batteries.
- If you intend not to use the remote control for a long time, remove the batteries to prevent damage from leakage or corrosion.
- Remove expired batteries as soon as possible to prevent damage from leakage or corrosion.

## To install the batteries:

- 1 Remove the cover.

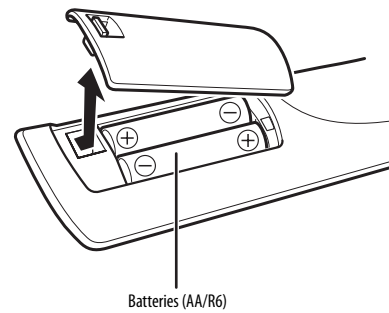

- 2 Insert two AA batteries into the compartment matching the polarity indicated.
- 3 Replace the cover.

## Using the remote control

Use the remote control by pointing it towards the receiver's remote sensor window. Objects between the remote control and sensor window may prevent proper operation.

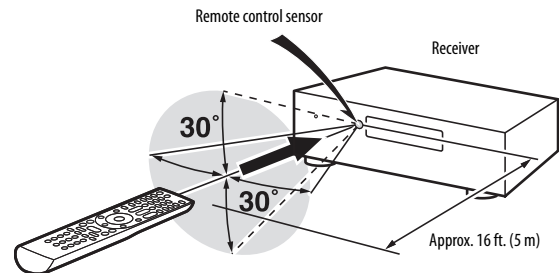

Use the remote control within about 16 feet (5 meters) of the receiver and within 30 degrees of perpendicular to the front of the receiver.

### Cautions

- Do not expose the remote control to shock. In addition, do not expose the remote control to liquids, and do not place in an area with high humidity.
- Do not place the remote control under direct sunlight. The heat may cause deformation of the remote control.
- The remote control may not work properly if the remote sensor window of the receiver is under direct sunlight or strong lighting. In such a case, change the angle of the lighting or receiver, or operate the remote control closer to the remote sensor window.

## Using the Audyssey 2EQ® room correction and speaker setup

With the supplied calibration microphone, Audyssey 2EQ automatically determines the number of speakers connected, their size (for purposes of bass management), optimum crossover frequencies to the subwoofer (if present), and distances from the primary listening position. Audyssey 2EQ then removes the distortion caused by room acoustics by capturing room acoustical problems over the listening area in both the frequency and time domain. The result is clear, well-balanced sound for everyone.

Enabling Audyssey 2EQ lets you also use Audyssey Dynamic EQ®, which maintains the proper octave-to-octave balance at any volume level.



Before using this function, connect and position all of your speakers.

It takes about 15 minutes to complete the room correction and speaker setup for three positions. Total measurement time varies depending on the number of speakers.

### Using Audyssey 2EQ

To create a listening environment in your home theater that all listeners can enjoy, Audyssey 2EQ takes measurements at up to three positions within the listening area.

Position the microphone at ear height of a seated listener with the microphone tip pointed directly at the ceiling using a tripod. Do not hold the microphone in your hand during measurements as this produces inaccurate results.

**First measurement position (1)**—Also referred to as the Main Listening Position this refers to the most central position where one would normally sit within the listening environment. 2EQ uses the measurements from this position to calculate speaker distance, level, polarity, and the optimum crossover value for the subwoofer.

**Second measurement position (2)**—The right side of the listening area.

**Third measurement position (3)**—The left side of the listening area.

The distances from position 1 to 2 and 1 to 3 must be at least 3.3 feet (1 meter).

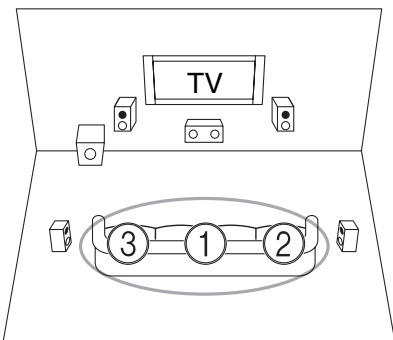

#### Notes

- Make the room as quiet as possible. Background noise and Radio Frequency Interference (RFI) can disrupt the room measurements. Close windows, and turn off televisions, radios, air conditioners, fluorescent lights, home appliances, light dimmers, or other devices. Silence the cell phone (even if it is not in use) or place it away from all audio electronics.
- The microphone picks up test tones which played through each speaker as Audyssey 2EQ Room Correction and Speaker Setup run.

### To use Audyssey to set up and correct your speakers:

#### Note

- Room correction and speaker setup cannot be performed while a pair of headphones is connected.

- 1 Turn on the receiver and the connected TV.
- 2 On the TV, select the input to which the receiver is connected.

- 3 Set the speaker setup microphone at the Main Listening Position 1, and connect it to the **SETUP MIC** jack on the front of the receiver.

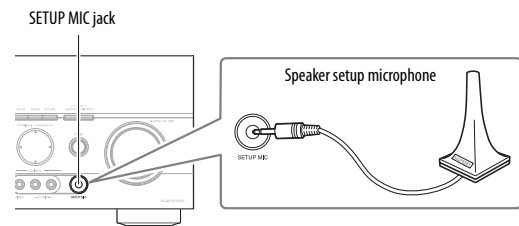

The speaker setting menu appears.

#### Note

The on-screen setup menus only appear on a TV that is connected to the **HDMI OUT** jack. If your TV is connected to the **MONITOR OUT V** or **COMPONENT VIDEO OUT** jacks, use the receiver's display when changing the settings.

- 4 Press **ENTER**.

The room correction and speaker setup starts. Test tones are played through each speaker as Audyssey 2EQ Room Correction and Speaker Setup runs. This process takes a few minutes. Refrain from talking during measurements and do not stand between speakers and the microphone. Do not disconnect the speaker setup microphone during the room correction and speaker setup unless you want to cancel the setup.

- 5 Place the setup microphone at the next position, then press **ENTER**.

Audyssey 2EQ performs more measurements. This takes a few minutes.

- 6 When prompted, place the setup microphone at the next position, then repeat step 5.

- 7 Use **▼** or **▲** to select an option, then press **ENTER**. The options are:

- **Save**—To save the calculated settings and exit the room correction and speaker setup.
- **Cancel**—To cancel the room correction and speaker setup.

#### Note

You can view the calculated settings for the speaker configuration, speaker distances, and speaker levels by using **◀** or **▶**.

- 8 Disconnect the speaker setup microphone.

#### Notes

- When Audyssey 2EQ Room Correction and Speaker Setup is complete, **Audyssey** is set to **On** and the Audyssey indicator lights.
- You can cancel Audyssey 2EQ Room Correction and Speaker Setup at any point in this procedure by disconnecting the setup microphone.
- Do not connect or disconnect any speakers during Audyssey 2EQ Room Correction and Speaker Setup.
- If the receiver is muted, it will be unmuted automatically when Audyssey 2EQ Room Correction and Speaker Setup starts.
- Changes to the room after Audyssey 2EQ Room Correction and Speaker Setup requires that you run Audyssey 2EQ Room Correction and Speaker Setup again, as room EQ characteristics may have changed.

## Error Messages

While the room correction and speaker setup is in progress, one of the following error messages may appear:

- **Retry**—Try again.
- **Cancel**—Cancel the room correction and speaker setup.
- **Ambient noise is too high**—The background noise is too loud. Remove the source of the noise and try again.
- **Speaker Matching Error!**—The number of speakers detected was different from that of the first measurement. Check the speaker connection.
- **Writing Error!**—This message appears if saving fails. Try saving again. If this message appears after two or three attempts, contact your Insignia dealer.
- **Speaker Detect Error**—This message appears if a speaker is not detected. **No** means that no speaker was detected.

## Changing the speaker settings manually

You can manually make changes to the settings found during the room correction and speaker setup.

See also:

- “Configuring speakers (Sp Config menu)” on page 20.
- “Setting speaker distance (Sp Distance menu)” on page 20.
- “Setting the level calibration (Level Cal menu)” on page 21.

## Using the powered subwoofer

The powered subwoofer outputs very low-frequency sound at a low volume level, therefore it may not be detected by Audyssey 2EQ Room Correction and Speaker Setup.

If **Subwoofer** appears on the *Review Speaker Configuration* screen as **No**, increase the subwoofer’s volume to the half-way point, set it to its highest crossover frequency, and then try running Audyssey 2EQ Room Correction and Speaker Setup again. Note that if the volume is set too high and the sound distorts, detection issues may occur, so use an appropriate volume level. If the subwoofer has a low-pass filter switch, set it to **Off** or **Direct**.

# Operating your receiver

## Turning your receiver on and off

### To turn your receiver on and off:

- 1 Press **ON/STANDBY** on the front panel.  
- OR -  
Press **RECEIVER**, then **ON/STANDBY** on the remote control.  
The receiver turns on, the display lights, and the **STANDBY** indicator turns off.
- 2 Press **ON/STANDBY** on the remote control again. The receiver enters standby mode.  
To prevent any loud surprises when you turn on the receiver, always turn down the volume before you turn it off.

## Understanding basic operations

### Notes

- The on-screen setup menus appear only on a TV that is connected to the **HDMI OUT** jack. If your TV is connected to the **MONITOR OUT V** or the **COMPONENT VIDEO OUT** jacks, use the receiver’s display when changing settings.
- This manual describes the procedure using the remote control unless otherwise specified.

### Playing a connected component

#### To play a connected component:

- 1 Press **RECEIVER**, then press **INPUT SELECTOR** buttons to select the input source.
- 2 Start playback on the source component.
- 3 To adjust the volume, use the **MASTER VOLUME** control.
- 4 Select a listening mode and enjoy!  
See also “Using the listening modes” on page 16.

### Displaying source information

#### To display source information:

- Press **RECEIVER**, then press **DISPLAY** repeatedly to cycle through the available information.

The following information can typically be displayed:

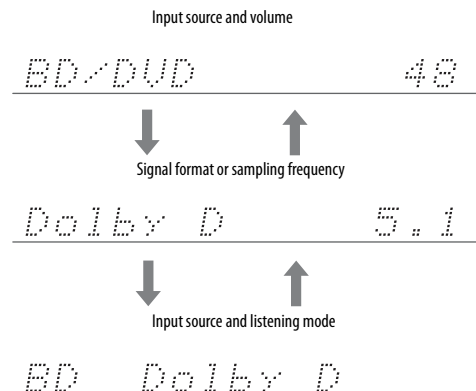

### Notes

- When AM or FM radio is used, the band, preset number, and frequency are displayed.
- If the input signal is analog, no format information is displayed. If the input signal is PCM, the sampling frequency is displayed. If the input signal is digital but not PCM, the signal format is displayed. Information is displayed for about three seconds, then the previously displayed information reappears.
- The input source is displayed with the default name even when you have selected a name. See “Naming inputs (Name Edit menu)” on page 22.

### Using the music optimizer

The music optimizer enhances the sound quality of compressed music files.

#### To use the music optimizer:

- 1 Press **AUDIO**, then press **▲** or **▼** to select **M.Optimizer**.
- 2 Press **◀** or **▶** to select **On**.

The **M.Opt** indicator lights on the display.

#### Notes

- The music optimizer function only works with PCM digital audio input signals with a sampling rate below 48 kHz and analog audio input signals. The music optimizer is disabled when the direct listening mode is selected.
- The setting is stored individually for each input selector.

### Setting the display brightness

You can adjust the brightness of the receiver's display.

#### To set the display brightness:

- Press **RECEIVER**, then press **DIMMER** repeatedly to select: **Dim**, **Dimmer**, or **Normal** brightness.

### Muting the receiver

#### To mute the receiver:

- Press **RECEIVER**, then press **MUTING**. The output is muted and the **MUTING** indicator flashes on the display.

#### Tip

- To unmute, press **MUTING** again or adjust the volume.
- Muting is also cancelled when the receiver is set to Standby.

### Using the sleep timer

With the sleep timer, you can set the receiver to turn off automatically after a specified period.

#### To use the sleep timer:

- Press **RECEIVER**, then press **SLEEP** repeatedly to select the sleep time you want. The sleep time can be set from 90 to 10 minutes, in 10 minute steps.

The **SLEEP** indicator lights on the display when the sleep timer has been set. The specified sleep time appears on the display for about five seconds, then the previous display reappears.

#### Tip

- To cancel the sleep timer, press **SLEEP** repeatedly until the **SLEEP** indicator goes off.
- To check the time remaining until the receiver turns off, press **SLEEP**. If you press **SLEEP** while the sleep time is being displayed, the sleep time is shortened by 10 minutes.

### Using headphones

#### To use headphones:

- Connect a pair of stereo headphones with a standard plug (1/4 inch or 6.3 mm) to the **PHONES** jack.

#### Tip

- Always turn down the volume before connecting your headphones.
- While the headphones plug is inserted in the **PHONES** jack, the speakers are turned off.
- When you connect a pair of headphones, the listening mode is set to Stereo, unless it is already set to Stereo, Mono, or Direct.
- The listening modes cannot be selected while a pair of headphones is connected.

## Listening to your receiver

**Important:** The procedures described in this section use the buttons on the front panel, unless otherwise specified.

### Listening to the radio

With the built-in tuner you can enjoy AM and FM radio stations. You can store your favorite stations as presets for quick selection.

#### To listen to the radio:

- Press **TUNER** to select either **AM** or **FM** (each time you press **TUNER**, the radio band changes between AM and FM).

In this example, **FM** has been selected.

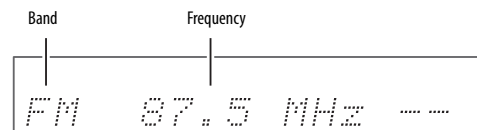

- To automatically tune to a station:
  - Press **TUNING MODE** until the **AUTO** indicator appears on the display.
  - Press **TUNING ▲** or **▼**. The receiver automatically searches for stations and stops when a station is found.

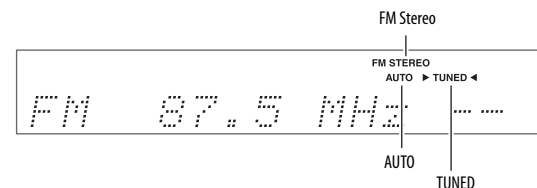

#### Tip

You can also press the **TUNE MODE** and arrow buttons on the remote control.

- OR -

- To manually tune to a station:
  - Press **TUNING MODE** until the **AUTO** indicator goes off.
  - Press and hold **TUNING ▲** or **▼**. The receiver tunes up or down the frequency band as long as you hold the button. Press the button repeatedly to tune up or down by steps.

#### Tip

- In Manual Tuning mode, FM stations are in mono.
- If the signal from a stereo FM station is weak, it may be impossible to get good reception. In this case, switch to Manual Tuning mode and listen to the station in mono.
- You can also press the **TUNE MODE** and arrow buttons on the remote control.

- OR -

- To tune to a station by entering the frequency:

- Using the remote control, press **TUNER** repeatedly to select **AM** or **FM**, then press **D.TUN**.

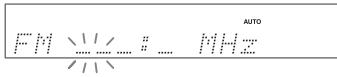

- Within eight seconds, press the number buttons to enter the frequency of the radio station you want. For example, to tune to 87.50, press **8**, **7**, then **5**.

## Presetting FM or AM stations

You can store a combination of as many as 40 of your favorite AM or FM stations as presets.

### To store a station as a preset:

- Tune to the FM or AM station that you want to store as a preset. See "Listening to the radio" on page 15 for information on tuning your receiver.
- Press **MEMORY**. The preset number flashes.
- While the preset number is flashing (about eight seconds), press **PRESET** ◀ or ▶ to select a preset number from one through 40.
- Press **MEMORY** again to store the station or channel. The station or channel is stored and the preset number stops flashing.
- Repeat steps 1 through 4 to preset your favorite radio stations.

### Tuning to a preset station

#### To tune to a preset station:

- To select a preset, press **PRESET** ◀ or ▶ on the receiver, or press **CH +/-** on the remote control.

#### Tip

You can also press the number buttons on the remote control to select a preset station directly.

### Deleting preset stations

#### To delete a preset station:

- Select the preset you want to delete.
- Press **TUNING MODE** while pressing and holding **MEMORY**. The preset is deleted and its number disappears from the display.

## Using the listening modes

#### Notes

- You can only select the Dolby Digital and DTS listening modes if your Blu-ray Disc/DVD player is connected to the receiver with a digital audio connection (coaxial, optical, or HDMI).
- The listening mode you can select depends on the format of the input signal. To check the format, see "Displaying source information" on page 14.
- You can only select **Mono**, **Direct**, and **Stereo** listening modes with a pair of headphones is connected.
- Listening modes cannot be selected while a pair of headphones is connected.

The receiver's listening modes can transform your listening room into a movie theater or concert hall, with high fidelity and stunning surround sound.

The following audio formats are supported by the listening modes:

- MONO**—This is mono (monophonic) sound. All the audio signals are mixed and reproduced through a single speaker.
- STEREO**—This is stereo (stereophonic) sound. Two independent audio signal channels are reproduced through two speakers.
- 5.1ch**—This is 5.1-channel surround sound. This surround system has five main channels of sound and a sixth subwoofer channel (called the point-one channel).
- 7.1ch**—This is 7.1-channel surround sound. This is a further sound enhancement to 5.1 channel sound with two additional speakers that provide greater sound envelopment and more accurate positioning of sounds. The receiver outputs this source in 5.1-channel surround sound.

### Selecting a listening mode

#### To select a listening mode:

- Press one of the following buttons. If you are using the remote control, press the **RECEIVER** button first. See "Listening modes" on page 17, and "Insignia-Original Listening Modes" on page 18 for information on listening modes.
  - MOVIE/TV**—This button selects the listening modes intended for use with movies and TV.
  - MUSIC**—This button selects the listening modes intended for use with music.
  - GAME**—This button selects the listening modes intended for use with video games.
  - STEREO**—This button selects the Stereo listening mode and All Channel Stereo listening mode.

## Listening modes

These listening modes become available when one of the buttons described in “Selecting a listening mode” on page 16 are pushed. The optional modes available depend on which button is pushed.

Listening Mode	Description	Input Source	Speaker Layout
<b>Direct (Direct)</b>	In this mode, audio from the input source is output without surround-sound processing. The “Sp Config (Speaker Configuration)” (presence of speakers), “Sp Distance (Speaker Distance)” and “A/V Sync (A/V Sync)” settings are enabled, but much of the processing set via AUDIO is disabled. See “Using advanced setup” on page 19 for more details.	MONO STEREO 5.1ch 7.1ch	2.1, 3.1, 5.1
<b>Stereo (Stereo)</b>	Sound is output by the front left and right speakers and subwoofer.	MONO STEREO 5.1ch 7.1ch	2.1, 3.1, 5.1
<b>Mono (Mono)</b>	Use this mode when watching an old movie with a mono soundtrack, or use it with the foreign language soundtracks recorded in the left and right channels of some movies. It can also be used with DVDs or other sources containing multiplexed audio, such as karaoke DVDs.	MONO STEREO 5.1ch 7.1ch	2.1, 3.1, 5.1
<b>Multichannel (Multich)</b>	Multichannel This mode is for use with PCM multichannel sources.	5.1ch 7.1ch	3.1, 5.1
<b>Dolby Pro Logic II (PL II Movie) (PL II Music) (PL II Game)</b>	Dolby Pro Logic II expands any 2-channel source for 5.1-channel playback. It provides a very natural and seamless surround-sound experience that fully envelops the listener. As well as music and movies, video games can also benefit from the dramatic spatial effects and vivid imaging. <ul style="list-style-type: none"> <li>Dolby PLII Movie—Use this mode with DVDs and videos that bear the Dolby Surround logo or TV shows that feature Dolby Surround. You can also use this mode with stereo movies or TV shows and the receiver creates a 5.1 surround mix from the 2-channel stereo.</li> <li>Dolby PLII Music—Use this mode to add 5.1 surround to stereo sources such as music CDs and DVDs.</li> <li>Dolby PLII Game—Use this mode when playing game discs.</li> </ul>	STEREO	3.1, 5.1
<b>Dolby Digital (Dolby D)</b>	Dolby Digital In this mode, audio from the input source is output without surround-sound processing. Sp Config (Speaker Configuration), (presence of speakers), Crossover (Crossover Frequency), Sp Distance (Speaker Distance), A/V Sync (A/V Sync), and much of the processing set via AUDIO are enabled. See “Using advanced setup” on page 19.	5.1ch	3.1, 5.1
<b>Dolby Digital Plus<sup>1</sup> (Dolby D+)</b>	In this mode, audio from the input source is output without surround-sound processing. Sp Config (Speaker Configuration), (presence of speakers), Crossover (Crossover Frequency), Sp Distance (Speaker Distance), A/V Sync (A/V Sync), and much of the processing set via AUDIO are enabled. See “Using advanced setup” on page 19.	5.1ch 7.1ch	3.1, 5.1
<b>Dolby TrueHD (Dolby TrueHD)</b>	In this mode, audio from the input source is output without surround-sound processing. Sp Config (Speaker Configuration), (presence of speakers), Crossover (Crossover Frequency), Sp Distance (Speaker Distance), A/V Sync (A/V Sync), and much of the processing set via AUDIO are enabled. See “Using advanced setup” on page 19.	5.1ch 7.1ch	3.1, 5.1
<b>DTS (DTS)</b>	In this mode, audio from the input source is output without surround-sound processing. Sp Config (Speaker Configuration), (presence of speakers), Crossover (Crossover Frequency), Sp Distance (Speaker Distance), A/V Sync (A/V Sync), and much of the processing set via AUDIO are enabled. See “Using advanced setup” on page 19.	5.1ch	3.1, 5.1
<b>DTS-HD High Resolution Audio (DTS-HD HR)</b>	In this mode, audio from the input source is output without surround-sound processing. Sp Config (Speaker Configuration), (presence of speakers), Crossover (Crossover Frequency), Sp Distance (Speaker Distance), A/V Sync (A/V Sync), and much of the processing set via AUDIO are enabled. See “Using advanced setup” on page 19.	5.1ch 7.1ch	3.1, 5.1
<b>DTS-HD Master Audio (DTS-HD MSTR)</b>	In this mode, audio from the input source is output without surround-sound processing. Sp Config (Speaker Configuration), (presence of speakers), Crossover (Crossover Frequency), Sp Distance (Speaker Distance), A/V Sync (A/V Sync), and much of the processing set via AUDIO are enabled. See “Using advanced setup” on page 19.	5.1ch 7.1ch	3.1, 5.1
<b>DTS Express (DTS Express)</b>	In this mode, audio from the input source is output without surround-sound processing. Sp Config (Speaker Configuration), (presence of speakers), Crossover (Crossover Frequency), Sp Distance (Speaker Distance), A/V Sync (A/V Sync), and much of the processing set via AUDIO are enabled. See “Using advanced setup” on page 19.	STEREO 5.1ch	3.1, 5.1
<b>DSD<sup>2</sup> (DSD)</b>	In this mode, audio from the input source is output without surround-sound processing. Sp Config (Speaker Configuration), (presence of speakers), Crossover (Crossover Frequency), Sp Distance (Speaker Distance), A/V Sync (A/V Sync), and much of the processing set via AUDIO are enabled. See “Using advanced setup” on page 19.	5.1ch	3.1, 5.1
<b>DTS 96/24<sup>3</sup> (DTS 96/24)</b>	This mode is for use with DTS 96/24 sources. This is high-resolution DTS with a 96 kHz sampling rate and 24-bit resolution, providing superior fidelity. Use it with DVDs that bear the DTS 96/24 logo.	5.1ch	3.1, 5.1
<b>DTS Neo:6 (Neo:6Cinema) (Neo:6Movie)</b>	This mode expands any 2-channel source for up to 5.1-channel playback. It uses seven full-bandwidth channels of matrix decoding for matrix-encoded material, providing a very natural and seamless surround sound experience that fully envelops the listener. <ul style="list-style-type: none"> <li><b>Neo:6 Cinema</b>—Use this mode with any stereo movie (such as TV, DVD, VHS).</li> <li><b>Neo:6 Music</b>—Use this mode with any stereo music source (such as CD, radio, cassette, TV, VHS, DVD).</li> </ul>	STEREO	3.1, 5.1

<sup>1</sup> Dolby Digital is used for Blu-ray discs.

<sup>2</sup> The receiver can use the DSD signal from HDMI IN. Setting the output on the player side to PCM might provide better sound to the player.

<sup>3</sup> Depending on the input source, DTS is used.



## Insignia-Original Listening Modes

Listening Mode	Description	Input Source	Speaker Layout
<b>Orchestra (Orchestra)</b>	Suitable for classical or operatic music, this mode emphasizes the surround channels in order to widen the stereo image, and simulates the natural reverberation of a large hall.	MONO STEREO 5.1ch	5.1
<b>Unplugged (Unplugged)</b>	Suitable for acoustic instruments, vocals, and jazz, this mode emphasizes the front stereo image, giving the impression of being right in front of the stage.	MONO STEREO 5.1ch	5.1
<b>Studio-Mix (Studio-Mix)</b>	Suitable for rock or pop music, listening to music in this mode creates a lively sound field with a powerful acoustic image, like being at a club or rock concert.	MONO STEREO 5.1ch	5.1
<b>TV Logic (TV Logic)</b>	This mode adds realistic acoustics to TV shows produced in a TV studio, surround effects to the entire sound, and clarity to voices.	MONO STEREO 5.1ch	5.1
<b>Game-RPG (Game - RPG)</b>	Use this mode when playing role playing game discs.	MONO STEREO 5.1ch	5.1
<b>Game-Action (Game - Action)</b>	Use this mode when playing action game discs.	MONO STEREO 5.1ch	5.1
<b>Game-Rock (Game - Rock)</b>	Use this mode when playing rock game discs.	MONO STEREO 5.1ch	5.1
<b>Game-Sports (Game - Sports)</b>	Use this mode when playing sports game discs.	MONO STEREO 5.1ch	5.1
<b>All Ch Stereo (All Ch St)</b>	Ideal for background music, this mode fills the entire listening area with stereo sound from the front, surround, and surround back speakers.	MONO STEREO 5.1ch 7.1ch	3.1, 5.1
<b>Full Mono (Full Mono)</b>	In this mode, all speakers output the same sound in mono, so the sound you hear is the same regardless of where you are within the listening room.	MONO STEREO 5.1ch 7.1ch	3.1, 5.1
<b>T-D (Theater-Dimensional) (T-D)</b>	With this mode you can enjoy a virtual surround sound even with only two or three speakers. This works by controlling how sounds reach the listener's left and right ears. Good results may not be possible if there is too much reverb, so we recommend that you use this mode in an environment with little or no natural reverb.	MONO STEREO 5.1ch 7.1ch	2.1, 3.1, 5.1

## Speaker layout

The following shows the speakers that are activated in each type of configuration.

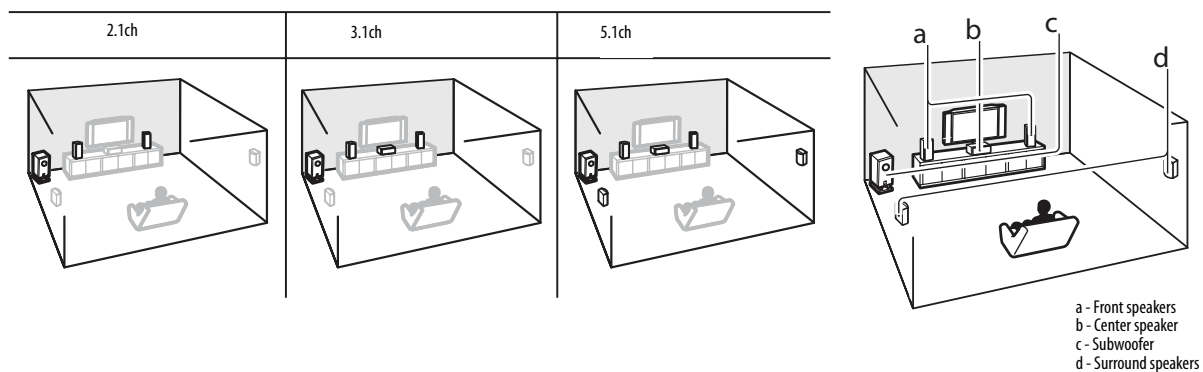

# Using advanced setup

## Using on-screen setup menus

On-screen setup menus appear on the connected TV and provide a convenient way to change the receiver's various settings. Settings are organized into nine categories on the main menu. You can change the settings by using the on-screen display.

### To use the on-screen setup menus:

- 1 Press **RECEIVER**, then press **SETUP**. The *Setup* menu opens.

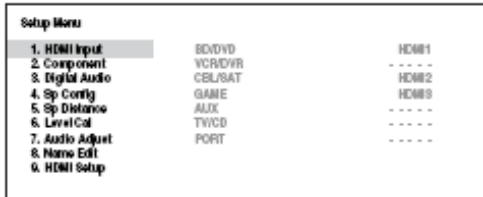

**Tip**  
If the main menu doesn't appear, make sure the appropriate external input is selected on your TV.

- 2 Press **▲** or **▼** to select a menu, then press **ENTER**.
- 3 Press **▲** or **▼** to select an option, then press **◀** or **▶** to change the setting.
- 4 Press **SETUP** to close the menu.
- 5 Press **RETURN** to return to the main menu.

**Tip**  
You can also performed these changes on the receiver by pressing **SETUP**, the arrow buttons, then **ENTER**.

## Setting up HDMI input (HDMI Input menu)

If you connect a video component to HDMI inputs, you must assign that input to an input selector. For example, if you connect your Blu-ray Disc/DVD player to **HDMI IN 2**, you must assign **HDMI2** to the **BD/DVD** input selector.

Here are the default assignments:

Input selector	Default assignment
BD/DVD	HDMI1
VCR/DVR	-----
CBL/SAT	HDMI2
GAME	HDMI3
AUX	-----
TV/CD	-----
PORT	-----

**HDMI1, HDMI2, HDMI3**—Select the HDMI input to which the video component has been connected.  
-----Select if you're not using the **HDMI OUT**.

Each HDMI input can only be assigned to a single input selector. When HDMI1 - HDMI3 have already been assigned, you must first set unused input selectors to "-----," or you cannot assign HDMI1 - HDMI3 to an input selector.

**Notes**

- When an **HDMI IN** is assigned to an input selector as explained here, the digital audio input for that input selector is automatically set to the same **HDMI IN**.
- If you connect a component to a **UNIVERSAL PORT** jack, you cannot assign any input to the **PORT** selector.
- Do not assign the component connected with the HDMI input to a **TV/CD** selector when you set the TV Control setting to **On**. Otherwise, the appropriate CEC (Consumer Electronics Control) operation can not be guaranteed.

## Setting up Component input (Component menu)

**Tip**  
If you connect an input component to the **UNIVERSAL PORT** jack, you cannot assign any input to the **PORT** selector.

If you connect a video component to a component video input, you must assign that input to an input selector. For example, if you connect your Blu-ray Disc/DVD player to **COMPONENT VIDEO IN 2**, you must assign **IN2** to the **BD/DVD** input selector.

Here are the default assignments:

Input selector	Default assignment
BD/DVD	IN1
VCR/DVR	-----
CBL/SAT	IN2
GAME	-----
AUX	-----
TV/CD	-----
PORT	-----

**IN1, IN2**—Select the component input to which the video component has been connected.

-----Select if you're not using the **COMPONENT VIDEO OUT**.

## Setting up Digital Audio (Digital Audio menu)

If you connect a component to a digital audio input, you must assign that input to an input selector. For example, if you connect your CD player to the **OPTICAL IN 1**, you must assign **OPT1** to the **TV/CD** input selector.

Here are the default assignments:

Input selector	Default assignment
BD/DVD	COAX
VCR/DVR	-----
CBL/SAT	-----
GAME	OPT1
AUX	-----
TV/CD	OPT2
PORT	-----

**COAX, OPT1, OPT2**—Select the digital audio input to which the video component has been connected.

-----Select if you are using an analog audio input.

**Notes**

- When an **HDMI IN** is assigned to an input selector as explained here, the digital audio input for that input selector is automatically set to the same **HDMI IN**. In addition to the usual inputs, such as **COAX**, you can also select HDMI inputs.
- The available sampling rate for PCM signals from a digital input (optical and coaxial) is 32/44.1/48/88.2/96 kHz/16, 20, 24 bit.
- If you connect a component to a **UNIVERSAL PORT** jack, you cannot assign any input to the **PORT** selector.

## Configuring speakers (*Sp Config* menu)

**Note**

Some of the settings in this section are made automatically by the Audyssey 2EQ® Room Correction and setup function. See "Using the Audyssey 2EQ® room correction and speaker setup" on page 12.

This section explains how to specify which speakers are connected and defines their sizes.

For speakers with a cone diameter larger than 6.5 inches (16 cm), specify **Large** (full band). For those with a smaller diameter, specify **Small** (default crossover 120Hz).

The crossover frequency can be changed in the *Crossover* submenu.

**Note**

Speaker Configuration, Crossover Frequency, and Double Bass settings are disabled while headphones are connected, or when **Audio TV OUT** is set to **On**.

Speaker(s)	Configuration
<b>Subwoofer</b>	<b>Yes</b> —if a subwoofer is connected. <b>No</b> —if no subwoofer is connected.
<b>Front</b>	<b>Small</b> —If speaker cone is 6.5 inches (16 cm) or less in diameter. <b>Large</b> —If speaker cone is larger than 6.5 inches (16 cm) in diameter. <b>Note:</b> If the <b>Subwoofer</b> setting is <b>No</b> , the default setting for this is <b>Large</b> and cannot be changed. <b>Small</b> —If speaker cone is 6.5 inches (16 cm) or less in diameter. <b>Large</b> —If speaker cone is larger than 6.5 inches (16 cm) in diameter.
<b>Center and Surround</b>	<b>None</b> —If no center speaker is connected. <b>Note:</b> If the <b>Front</b> setting is <b>Small</b> , the <b>Large</b> option cannot be selected. When Speakers B is On, these speakers output no sound.

### Setting the crossover frequency (*Crossover Frequency* submenu of *Sp Config* menu)

This setting is recommended for the speakers that you specify as **Small**. To get the best bass performance from your speaker system, you need to set the crossover frequency according to the size and frequency response of your speakers. Options include **40Hz, 50Hz, 60Hz, 80Hz, 100Hz, 120Hz, 150Hz, and 200Hz**.

Use the diameter of the smallest speaker in your system when choosing the crossover frequency.

Speaker cone diameter	Recommended Crossover Frequency
Over 8 in. (20 cm)	40/50/60 Hz
6-1/2 to 8 in. (16 to 20 cm)	80 Hz
5-1/4 to 6-1/2 in. (13 to 16 cm)	100 Hz
3-1/2 to 5-1/4 in. (9 to 13 cm)	120 Hz
Under 3-1/2 in. (9 cm)	150/200 Hz

**Notes**

- For a more accurate setting, look up your speaker's specifications.
- Choose a higher crossover frequency if you want more sound from your subwoofer.

### Using the Double Bass setting (*Double Bass* submenu of *Sp Config* menu)

Lets you boost bass output by feeding bass sounds from the front left, right, and center channels to the subwoofer. Optional settings are On and Off.

**Note**

This function can only be set if the **Subwoofer** setting is **Yes**, and the **Front** setting is **Large**. This setting is not made by Audyssey 2EQ®.

### Setting speaker distance (*Sp Distance* menu)

**Note**

This setting is made automatically by the Audyssey 2EQ® Room Correction and setup function. See "Using the Audyssey 2EQ® room correction and speaker setup" on page 12.

Lets you specify the distance from each speaker to the listening position so that the sound from each speaker arrives at the listener's ears as the sound designer intended.

Option	Configuration
<b>Unit</b>	<b>Feet (default)</b> —Distances can be set from 1 to 30 feet, in one foot increments. <b>Meters</b> —Distances can be set from 0.3 to 9.0 meters, in 0.3 meter increments.
<b>Left, Center, Right, Surround Right, Surround Left, Subwoofer</b>	Specify the distance from each speaker to your listening position.

**Notes**

- The speaker distance setting is disabled while headphones are connected, or when **Audio TV OUT** is set to **On**.
- Speakers that you set to **No** or **None** in the speaker configuration (*Sp Config* menu) cannot be selected.
- The Center, Right, and Subwoofer distances can be set up to 5 ft. (1.5 m) more or less than the Left distance. For example, if the Left distance is set to 20 ft. (6 m), the Center, Right, and Subwoofer distances can be set between 15 and 25 ft. (4.5 and 7.5 m).
- The Surround distances can be set up to 5 ft. (1.5 m) more or 15 ft. (4.5 m) less than the Left distance. For example, if the Left distance is set to 20 ft. (6 m), the SurrRight and SurrLeft distances can be set between 5 and 25 ft. (1.5 and 7.5 m).



## Setting the level calibration (*Level Cal* menu)

**Note**

This setting is made automatically by the Audyssey 2EQ® Room Correction and setup function. See "Using the Audyssey 2EQ® room correction and speaker setup" on page 12.

Lets you adjust the level of each speaker with the built-in test tone so that the volume of each speaker is the same at the listening position.

Option	Configuration
Left, Center, Right, Surround Right, Surround Left	-12 dB to 0 dB to +12 dB, in 1 dB steps.
Subwoofer	-15 dB to 0 dB to +12 dB, in 1 dB steps.

**Notes**

- The speaker level setting is disabled while headphones are connected, or the receiver is muted, or the Audio TV OUT setting is set to **ON**.
- Speakers that you set to **No** or **None** in the speaker configuration (*Sp Config* menu) cannot be selected.
- The center speaker and subwoofer level settings made by using **AUDIO** are saved here as the default settings.

**Tip**

If you're using a handheld sound level meter, adjust the level of each speaker so that it reads 75 dB SPL at the listening position, measured with C-weighting and slow reading.

## Adjusting the audio (*Audio Adjust* menu)

With the audio adjust settings you can adjust the sound and listening modes to your taste.

### Setting the Multiplex (*Input Ch(Mux)* submenu) and Mono (*Input Ch(Mono)* submenu)

The **multiplex** setting determines which channel of a stereo multiplex source is output. Use it to select audio channels or languages with multiplex sources, multilingual TV broadcasts, and so on. The **mono** setting specifies the channel to be used for playing any 2-channel digital source, such as Dolby Digital, or 2-channel analog/PCM source in the Mono listening mode.

Option	Settings
Multiplex	<b>Main (default)</b> —The main channel is output.
	<b>Sub</b> —The sub channel is output.
	<b>M/S</b> —Both the main and sub channels are output.
Mono	<b>L+R</b> —Both the left and right channels are output.
	<b>Left</b> —Only the left channel is output.
	<b>Right</b> —Only the right channel is output.

### Setting the Dolby options (*Panorama, Dimension, and Center Width* submenus)

These settings only apply to 2-channel stereo sources.

The **Panorama** setting lets you broaden the width of the front stereo image when using the Dolby Pro Logic II Music listening mode.

The **Dimension** setting lets you move the sound field forward or backward when using the Dolby Pro Logic II Music listening mode. Higher settings move the sound field backward. Lower settings move it forward. If the stereo image feels too wide, or there's too much surround sound, move the sound field forward to improve the balance. Conversely, if the stereo image feels like it's in mono, or there's not enough surround sound, move it backward.

The **Center Width** setting lets you adjust the width of the sound from the center speaker when using the Dolby Pro Logic II Music listening mode. Normally, if you're using a center speaker, the center channel sound is output by only the center speaker. (If you're not using a center speaker, the center channel sound is distributed to the front left and right speakers to create a phantom center). This setting controls the front left, right, and center mix, allowing you to adjust the weight of the center channel sound.

Submenu	Configuration
<b>Panorama</b>	<b>On</b> —Turns the Panorama function on. <b>Off</b> —Turns the Panorama function off.
<b>Dimension</b>	-3 to 0 to +3
<b>Center Width</b>	0 to 3 to 7

### Setting the DTS options (*Center Image* submenu)

The DTS Neo:6 Music listening mode lets you create 6-channel surround sound from 2-channel stereo sources. With this setting, you can specify by how much the front left and right channel output is attenuated in order to create the center channel.

A value **0** is only audible from the center speaker. A value of more than **0** is audible from the left and right speakers as well.

Submenu	Configuration
<b>Center Image</b>	0 to 2 (default) to 5

### Adjusting the Audyssey settings (*Audyssey, Dynamic EQ®, Dynamic Volume, and Reference Level* submenus)

Audyssey 2EQ is a room equalization solution that calibrates any audio system so that it can achieve optimum performance for every listener in a large listening area. Based on several room measurements, 2EQ calculates an equalization solution that corrects for both time and frequency response problems in the listening area and performs a fully automated surround system setup. With Audyssey **Dynamic EQ®**, you can enjoy great sound even when listening at low volume levels. Audyssey Dynamic EQ solves the problem of deteriorating sound quality as volume is decreased by taking into account human perception and room acoustics. It does so by selecting the correct frequency response and surround volume levels moment-by-moment, so that the content sounds the way it was created, at any volume level — not just at reference level.

**Note**

The setting is stored individually for each input selector.

Movies are mixed in rooms calibrated for film reference. To achieve the same **reference level** in a home theater system, each speaker level must be adjusted so that -30 dBFS band-limited (500 Hz to 2000 Hz) pink noise produces 75 dB sound pressure level at the listening position. A home theater system automatically calibrated by Audyssey 2EQ plays at reference level when the master volume control is set to the 0 dB position. At that level you can hear the mix as the mixers heard it.

Audyssey Dynamic EQ is referenced to the standard film mix level. It makes adjustments to maintain the reference response and surround envelopment when the volume is turned down from 0 dB. However, film reference level is not always used in music or other non-film content. The Dynamic EQ Reference Level Offset provides three offsets from the film level reference (5 dB, 10 dB, and 15 dB) that can be selected when the mix level of the content is not within the standard.

Submenu	Configuration
<b>Audyssey</b>	<b>Off</b> —No Audyssey 2EQ equalizing is applied. <b>On</b> — <b>Dynamic EQ</b> and <b>Dynamic Volume</b> become available. The <b>Audyssey</b> indicator lights.
<b>Dynamic EQ</b>	<b>Off (default)</b> —Audyssey Dynamic EQ off. <b>On</b> —Audyssey Dynamic EQ on. The <b>Dynamic EQ</b> indicator lights. <b>0 dB (default)</b> —Use when listening to movies. <b>5 dB</b> —Select this setting for content that has a very wide dynamic range, such as classical music. <b>10 dB</b> —Select this setting for jazz or other music that has a wider dynamic range. This setting should also be selected for TV content as that is usually mixed at 10 dB below film reference. <b>15 dB</b> —Select this setting for pop/rock music or other program material that is mixed at very high listening levels and has a compressed dynamic range.
<b>Reference Level</b>	
<b>Dynamic Volume</b>	<b>Off (default)</b> —Audyssey Dynamic Volume™ off. <b>Light</b> —Light Compression Mode becomes active. <b>Medium</b> —Medium Compression Mode becomes active. <b>Heavy</b> —Heavy Compression Mode becomes active. This setting affects volume the most, causing all sounds to be of equal loudness.

**Notes**

- The setting is stored individually for each input selector. If you make Dynamic Volume™ active, **Audyssey** and **Dynamic EQ** settings are set to **On**. The **Dynamic Vol** indicator lights.

**About Audyssey Dynamic EQ®**

Audyssey Dynamic EQ® solves the problem of deteriorating sound quality as volume is decreased by taking into account human perception and room acoustics.

Dynamic EQ selects the correct frequency response and surround levels moment-by-moment at any user selected volume setting. The result is bass response, tonal balance, and surround impression that remain constant despite changes in volume. Dynamic EQ combines information from incoming source levels with actual output sound levels in the room, a prerequisite for delivering a loudness correction solution.

Audyssey Dynamic EQ works in tandem with Audyssey 2EQ to provide well-balanced sound for every listener at any volume level.

**About Audyssey Dynamic Volume**

Audyssey Dynamic Volume solves the problem of large variations in volume level between television programs, commercials, and between the soft and loud passages of movies. Dynamic Volume looks at the preferred volume setting by the user and then monitors how the volume of program material is being perceived by listeners in real time to decide whether an adjustment is needed. Whenever necessary, Dynamic Volume makes the necessary rapid or gradual adjustments to maintain the desired playback volume level while optimizing the dynamic range. Audyssey Dynamic EQ is integrated into Dynamic Volume so that as the playback volume is adjusted automatically, the perceived bass response, tonal balance, surround impression, and dialog clarity remain the same whether watching movies, flipping between television channels, or changing from stereo to surround sound content.

**Adjusting the Theater-Dimensional setting (Listening Angle submenu)**

This setting lets you optimize the Theater-Dimensional listening mode by specifying the angle of the front left and right speakers relative to the listening position. Ideally, the front left and right speakers should be equidistant from the listening position and at an angle close to one of the two available settings.

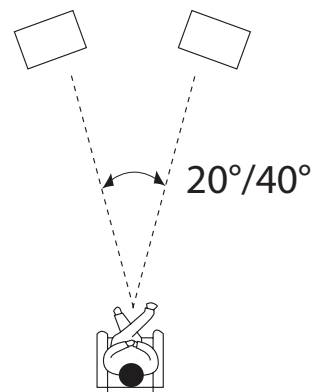

Submenu	Options
<b>Listening Angle</b>	<b>Wide (default)</b> —The listening angle is 40 degrees. <b>Narrow</b> —The listening angle is 20 degrees.

**Naming inputs (Name Edit menu)**

You can enter a preset name for each individual input selector for easy identification. When entered, the preset name appears on the display.

Before selecting a name, press the input selector to select the input source to name.

Submenu	Options
<b>Name Edit</b>	--, <b>Blu-ray, DVD, HD DVD, VCR, DVR, Tivo, CableSTB, SAT STB, PS3, Wii, Xbox, PC, TV, CD, TAPE,</b> and <b>iPod.</b> To reset to the default, select ---.

**Notes**

- Two different inputs cannot have the same name.
- This menu cannot be used for the **TUNER** input selector.

**Setting up HDMI (HDMI Setup menu)**

Submenu	Configuration
<b>Audio TV OUT</b>	<b>Off (default)</b> —HDMI audio is not output. <b>On</b> —HDMI audio is output.
<b>LipSync</b>	<b>Disable (default)</b> —HDMI lip sync disabled. <b>Enable</b> —HDMI lip sync enabled.
<b>CEC Function</b>	<b>Off (default)</b> —CEC disabled. <b>On</b> —CEC enabled.
<b>Audio Return Ch (ARC)</b>	<b>Off</b> —Select if you don't want to use audio return channel (ARC) function. <b>Auto (default)</b> —The audio signal from your TV tuner can be sent digitally to the HDMI OUT of the receiver.
<b>Power Control</b>	<b>Off</b> —Power Control disabled. <b>On (default)</b> —Power Control enabled.
<b>TV Control</b>	<b>Off</b> —TV Control disabled. <b>On (default)</b> —TV Control enabled.

**Audio TV OUT (Audio TV Out submenu)**

This setting determines whether audio received by HDMI IN is output by the HDMI OUT. You may want to turn this preference on if your TV is connected to the HDMI OUT and you want to listen to the audio from a component that's connected to an HDMI IN, through your TV's speakers. Normally, this should be set to **Off**.

**Notes**

- If **On** is selected and the signal can be output by the TV, the receiver outputs no sound through its speakers.
- If **On** is selected, **TV Sp On** appears on the display when you press **DISPLAY**.
- When **TV Control** is set to **On**, this setting default is **Auto**.
- With some TVs and input signals, no sound may be output, even when this setting is **On**.
- When the **Audio TV OUT** or **TV Control** are set to **On**, and you are listening through your TV's speakers, if you turn up the receiver's volume control, the sound is output by the receiver's front left and right speakers. To stop the receiver's speakers from producing sound, change the settings, change your TV's settings, or turn down the receiver's volume.

**LipSync (LipSync submenu)**

Lets you set the receiver to automatically correct any delay between the video and the audio, based on the data from the connected monitor.

**Notes**

- This function only works if your HDMI-compatible TV supports HDMI Lip Sync.
- You can check the amount of delay being applied by the HDMI Lip Sync function on the A/V Sync screen.

**CEC Function (HDMI Control submenu)**

This function lets CEC-compatible components connected via HDMI to be controlled by the receiver.

**Notes**

- When set to **On**, the name of connected CEC-compatible components and **CEC On** are displayed on the receiver when the menu is closed.
- When set to **Off**, **CEC Off** is displayed on the receiver when the menu is closed.
- When a CEC-compatible component is connected to the receiver via HDMI cable, the name of the connected component is displayed on the receiver. For example, when you are watching TV, if you turn on a Blu-ray Disc/DVD player by the receiver's remote control, the name of the Blu-ray Disc/DVD player is displayed on the receiver.
- Set to **Off** when a connected piece of equipment is not compatible or it is unclear whether the equipment is compatible or not.
- If movement is unnatural when set to **On**, change the setting to **Off**.
- Refer to the connected component's instruction manual for details.

**Audio Return Ch (ARC)(Audio Return Ch submenu)**

The audio return channel (ARC) function enables an HDMI 1.4-capable TV to send the audio stream to the HDMI OUT jack of the receiver. To use this function, you must select the TV/CD input and your TV must support the ARC function.

**Notes**

- The **Audio Return Ch** setting can only be set when **HDMI Control** is **On**.
- This setting is set to **Auto** automatically when **HDMI Control** is set to **On** first time.

**Power Control (Power Control submenu)**

To link the power functions of CEC-compatible components connected via HDMI, select **On**. This is set to **On** automatically when **HDMI Control** is set to **On** first time.

**Notes**

- The **Power Control** can only be set when the **HDMI Control** setting is **On**.
- HDMI power control only works with CEC-compatible components that support it and may not work with some components.
- When set to **On**, power consumption increases.
- When set to **On**, regardless of whether the receiver is **On** or in **Standby**, both audio and video stream from an HDMI input is output to the TV or other components via HDMI connection (HDMI pass-through function). When the HDMI pass-through function activates in standby mode, the **HDMI THRU** indicator lights.
- The power consumption during standby mode increases during the HDMI pass-through, however when the TV is in standby mode or you are watching a TV program, power consumption can be improved.
- Refer to the connected component's instruction manual for details.

## TV Control (TV Control submenu)

Set to **On** when you want to control the receiver from a CEC-compatible TV that is connected to HDMI.

### Notes

- Do not assign the component connected with the HDMI input to the TV/CD selector when you set **TV Control** to **On**. Otherwise, appropriate CEC (Consumer Electronics Control) operation is not guaranteed.
- Set to **Off** when the TV is not compatible or when it is unclear whether the TV is compatible or not.
- **TV Control** can be set only when **HDMI Control** and **Power Control** are both set to **On**.
- Refer to the connected component's instruction manual for details.
- After changing the **HDMI Control**, **Power Control**, or **TV Control** settings, turn off the power to all connected pieces of equipment and then turn them on again. Refer to the user's manuals for all connected pieces of equipment.

- **Center**—**12 dB to 0 dB to +12 dB**, in 1 dB steps.

### Notes

- You cannot use this function while the receiver is muted.
- Speakers that are set to **No** or **None** in the *Sp Config* (Speaker Configuration) submenu cannot be adjusted.

## Changing audio settings

You can change various audio settings by pressing **AUDIO** on the remote control.

### Note

When **Audio TV OUT** is set to **On**, the **AUDIO** button is disabled.

### To change audio settings:

- 1 Press **RECEIVER** on the remote control, then press **AUDIO**.
- 2 Press **▲** or **▼** to select an option, then press **◀** or **▶** to change the setting. Repeat this step to change additional settings.

## Changing tone control settings

You can adjust the bass and treble for the front speakers, except when the Direct listening mode is selected. Options include:

- **Bass**—You can boost or cut low-frequency sounds output by the front speakers. **10 dB to 0 dB to +10 dB**, in 2 dB steps
- **Treble**—You can boost or cut high-frequency sounds output by the front speakers. **10 dB to 0 dB to +10 dB**, in 2 dB steps

### Notes

- To bypass the bass and treble tone circuits, select the **Direct** listening mode.
- This procedure can also be performed on the receiver by pressing the **TONE-/+** buttons.

## Changing the speaker levels

You can adjust the volume of each speaker while listening to an input source. These temporary adjustments are cancelled when the receiver is set to Standby. To save the setting you made here, go to "Setting the level calibration (Level Cal menu)" on page 21, before returning the receiver to Standby. Options include:

- **Subwoofer**—**15 dB to 0 dB to +12 dB**, in 1 dB steps.

## Changing Audyssey settings

See "Adjusting the audio (Audio Adjust menu)" on page 21. Options include:

- **Dynamic EQ®**
- **Dynamic Volume**

## Setting the Late Night function

The Late Night function lets you reduce the dynamic range of Dolby Digital material so that you can still hear quiet parts even when listening at low volume levels. This makes it ideal for watching movies late at night when you do not want to disturb anyone. Options are:

- For Dolby Digital and Dolby Digital Plus sources, the options are **Off**, **Low**, and **High**.
- For Dolby TrueHD sources, the options are **Auto**, **Off**, and **On**.

### Notes

- The effect of the Late Night function depends on the material that you are playing and the intention of the original sound designer. With some material there is little or no effect when you select the different options.
- The Late Night function can only be used when the input source is Dolby Digital, Dolby Digital Plus, or Dolby TrueHD.
- The Late Night function is set to **Off** when the receiver is set to Standby. For Dolby TrueHD sources, it is set to **Auto**.

## Setting the Music Optimizer

The Music Optimizer function enhances the sound quality of compressed music files. Use it with music files that use "lossy" compression, such as MP3. Options are **Off** and **On**.

### Notes

- The Music Optimizer function only works with PCM digital audio input signals with a sampling rate below 48 kHz and analog audio input signals. The Music Optimizer is disabled when the Direct listening mode is selected.
- The setting is stored individually for each input selector.
- When the Music Optimizer is on, the **M.OPT** indicator lights.

## Setting the CinemaFILTER

The CinemaFILTER lets you soften overly bright movie soundtracks, which are typically mixed for reproduction in a movie theater.

CinemaFILTER can be turned **On** or **Off** for the following listening modes:

- Dolby Digital
- Dolby Digital Plus
- Dolby TrueHD
- Dolby Pro Logic II Movie
- Multichannel



- DTS
- DTS Neo:6 Cinema
- DTS 96/24
- DTS-HD High Resolution
- DTS-HD Master
- DTS Express.

#### Notes

The CinemaFILTER may not work with some input sources.

#### Notes

- If the beginnings of tracks from a PCM source are cut off, try setting the format to PCM.
- If noise is produced when fast forwarding or reversing a DTS CD, try setting the format to DTS.
- The setting is stored individually for each input selector.
- The setting is reset to **Auto** when you change the setting in the Audio Selector.

### Setting the Audio Selector

You can set priorities of audio output when there are both digital and analog inputs. Options include:

- **ARC**—The audio signal from your TV tuner can be sent digitally to the **HDMI OUT** of the receiver. With this selection, the TV's audio can automatically be selected as a priority.
- **HDMI**—This can be selected when **HDMI IN** has been assigned as an input source. If both HDMI (**HDMI IN**) and digital audio inputs (**COAXIAL IN** or **OPTICAL IN**) have been assigned, HDMI input is automatically selected.
- **COAX**—This can be selected when **COAXIAL IN** has been assigned as an input source. If both coaxial and optical inputs have been assigned, coaxial input is automatically selected.
- **OPT**—This can be selected when **OPTICAL IN** has been assigned as an input source.
- **Analog**—The receiver always outputs analog signals.

#### Notes

- The setting is stored individually for each input selector.
- This setting can be made only for the input source that is assigned as HDMI IN, COAXIAL IN, or OPTICAL IN. If both HDMI (HDMI IN) and digital audio inputs (COAXIAL IN or OPTICAL IN) are assigned, HDMI input is selected as a priority by setting to **ARC**. To select the digital audio input, see "Setting up Digital Audio (Digital Audio menu)" on page 19.
- You can select **ARC** if you select the TV/CD input selector. But you cannot select it if you have selected **Off** in the Audio Return Ch setting.

### Setting the A/V Sync

When using progressive scanning on your Blu-ray Disc/DVD player, you may find that the picture and sound are out of sync. With this setting, you can correct this by delaying the audio signals. Option settings are from **0 ms** to **100 ms**, in 10 ms steps.

#### Notes

- A/V Sync is disabled when the Direct listening mode is used with an analog input source.
- The setting is stored individually for each input selector.

### Selecting a digital input signal format

The digital input signal formats are available only for the input sources that you have assigned a digital input jack.

Normally, the receiver detects the signal format automatically. However, if you experience any issues when playing PCM or DTS material, you can manually set the signal format to PCM or DTS.

#### To select a digital input signal format:

- 1 Press **RECEIVER**, then press and hold **AUDIO** for about eight seconds. **Auto** appears on the display.
- 2 Press **◀** or **▶** to select one of the following options:
  - **Auto**—The format is detected automatically. If no digital input signal is present, the corresponding analog input is used instead.
  - **PCM**—Only 2-channel PCM format input signals are heard. If the input signal is not PCM, the PCM indicator flashes and noise may also be produced.
  - **DTS**—Only DTS (but not DTS-HD) format input signals is heard. If the input signal is not DTS, the DTS indicator flashes and there is no sound.

## Controlling other components

You can use your receiver's remote control to control your other AV components. This section explains how to enter the remote control code for a component that you want to control, such as a DVD player, a TV, or a CD player. See "Remote control codes" on page 27.

### Preprogrammed remote control codes

Remote control codes for Insignia Blu-ray disc players and Insignia TVs are preprogrammed into the remote control. You do not need to enter a remote control code to control these components.

#### To enter remote control codes:

- 1 While holding down the **REMOTE MODE** button to which you want to enter a code, press and hold down the **DISPLAY** button until the Remote indicator lights up (about three seconds).
- 2 Within 30 seconds, press the number buttons to enter the 5-digit remote control code. The **Remote** indicator flashes twice.

#### To reset a REMOTE MODE button:

- 1 While holding down the **REMOTE MODE** button that you want to reset, press and hold **AUDIO** until the remote indicator lights (about three seconds).
- 2 Within 30 seconds, press the **REMOTE MODE** button again.  
The remote indicator flashes twice, indicating that the button has been reset.

Each **REMOTE MODE** button is preprogrammed with a remote control code. When a button is reset, its preprogrammed code is restored.

#### To reset the remote control:

- 1 While holding down the **RECEIVER** button, press and hold **AUDIO** until the remote indicator lights (about three seconds).
- 2 Within 30 seconds, press the **RECEIVER** button again.
- 3 The remote indicator blinks twice, indicating that the remote control has been reset.

#### To control other components:

- Press the **REMOTE MODE** button that you have programmed with the remote control code for your component.

## Using the remote control to control other components

Press the **REMOTE MODE** button for the component you want to control first.

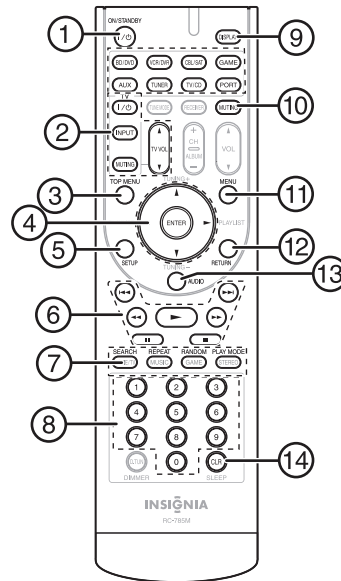

#	Button/ Component	TV	DVD player/ recorder	Blu-ray disc player	VCR/ PVR	Satellite/ Cable receiver
1	Power/ON/STANDBY	X	X		X	X
2	These buttons can control the TV, regardless of the mode selected.					
3	TOP MENU		X			
4	ENTER ◀/▶/ ▲/▼	X	X		X	X
5	SETUP					
6	▶/  /■/◀◀/ ▶▶/◀◀/▶▶	X	X		X	X
7	SEARCH	X*	X	X*		X*
	REPEAT	X*	X	X*		X*
	RANDOM	X*	X	X*		X*
	PLAY MODE	X*	X	X*		X*
8	Numbers	X	X		X	X
9	DISPLAY	X	X		X	X
10	MUTING	X	X		X	X
11	MENU		X			
12	RETURN	X	X		X	X
13	AUDIO	X	X			X
14	CLR	X	X		X	X

#### Note

Certain buttons may not work as expected with some components, and some may not work at all.

## Remote control codes

### Insignia Receiver

Default	62472
Zone 2	62545
Tuner	52472

### Cable Set Top Box

Bright House	01376, 01877
Cable One	01376, 01877
Cablevision	01006, 01376, 01877
Charter	01376, 01877
Cisco	01877, 01982
Comcast	01376, 01877, 01982
Cox	01376, 01877
Digeo	01187
Insight	01376, 01877
Knology	01877
Mediacom	01376, 01877
Motorola	01187, 01376, 01982
Pace	01376, 01877, 01982
Panasonic	01982
Pioneer	01877
Rogers	01877
Scientific Atlanta	01877
Shaw	01376
Sony	01006
Suddenlink	01376, 01877
Time Warner	01376, 01877
WideOpenWest	01877

### Cable/PVR Combination

Bright House	01376, 01877
Cable One	01376, 01877
Cablevision	01006, 01376, 01877
Charter	01376, 01877, 02187
Cisco	01877, 01982
Comcast	01376, 01877, 01982, 02576
Cox	01376, 01877
Digeo	01187, 02187
Insight	01376, 01877
Knology	01877
Mediacom	01376, 01877
Motorola	01376, 01187
Pace	01877
Panasonic	01982
Pioneer	01877
Rogers	01877
Scientific Atlanta	01877
Shaw	01376
Sony	01006
Suddenlink	01376, 01877
Time Warner	01376, 01877, 02187
Tivo	02576

### Cable/PVR Combination

WideOpenWest	01877
--------------	-------

### CD

Denon	72222
DKK	70000
Insignia	72585
Miro	70000
Optimus	70000, 70468
Pioneer	70468
RCA	70468
Sony	70000
Yamaha	70036

### CD-R

Sony	70000
------	-------

### Accessory

Insignia	82587
AT&T	00858
Cisco	02345
Motorola	00858, 02378
Scientific Atlanta	00858, 02345
Verizon	02378

### Satellite Set Top Box

Bell ExpressVu	00775
DirecTV	00247, 00566, 00639, 00749, 01142, 01377, 01442, 01609, 01749
Dish Network	00775, 01775
Dishpro	00775, 01775
EchoStar	00775, 01775
Expressvu	00775, 01775
GE	00566
General Instrument	00869
GOI	00775, 01775
HTS	00775, 01775
Hughes Network Systems	00749, 01142, 01442, 01749
Jerrold	00869
JVC	00775, 01775
Mitsubishi	00749
Motorola	00869
Next Level	00869
Panasonic	00247
Philips	00749, 01142, 01442, 01749
Proscan	00566
RadioShack	00869
RCA	00566
Samsung	01377, 01442, 01609
Sony	00639
Star Choice	00869
Tivo	01142, 01442
Toshiba	00749, 01749
Voom	00869

**SAT/PVR Combination**

Bell ExpressVu	00775
DirecTV	00639, 01142, 01377, 01442
Dish Network	00775
Dishpro	00775
EchoStar	00775
Expressvu	00775
Hughes Network Systems	01142, 01442
Motorola	00869
Philips	01142, 01442
Samsung	01442
Sony	00639
Star Choice	00869
Tivo	01142, 01442

**Television**

Akai	10812, 11675
Dynex	11780, 12049, 12184
Electrograph	11755
Emerson	11394, 11864, 11963
ESA	10812, 11963
Funai	11963
Gateway	11755
GFM	11963
Hisense	11660
Hitachi	11643
Insignia	11204, 11423, 11517, 11564, 11660, 11780, 11892, 11963, 12002, 12049, 12417
JVC	11601
LG	11423, 12358
Magnavox	11454, 11866, 11963
Marantz	11454
Maxent	11755
Memorex	11892
Mitsubishi	11250
NEC	11797
NetTV	11755
Olevia	11610
Panasonic	11457, 11480
Petters	11523
Philco	11394, 11963
Philips	11454, 11744
Pioneer	11457
Polaroid	11523, 12002
RCA	11781, 12002, 12187, 12247, 12434
Sampo	11755
Samsung	10812
Sansui	11892
Sanyo	11142
Sharp	10818
Sony	10810
SVA	11963
Sylvania	11394, 11864, 11963
Syntax	11610

**Television**

Toshiba	11524, 12006
Viewsonic	10857, 11627, 11755
Vizio	11758
Westinghouse	10889, 11712
Zenith	11423

**VCR**

DirecTV	20739
Humax	20739
Philips	20739
Tivo	20739

**PVR**

DirecTV	20739
Humax	20739
Philips	20739
Tivo	20739

**DVD**

Accurian	33002
California Audio Labs	30490
Denon	30490, 31634, 33010
Disney	33002
Emerson	33002
Funai	33002
GE	30522
GFM	33002
Go Video	33003
GoldStar	33003
Grundig	30539
Hitachi	30573
Insignia	32095, 33002, 33014, 33025
Integra	31634, 32900
JVC	32365
Kenwood	30490
LG	33003
Magnavox	30503, 30539, 33002
Marantz	30539, 33013
Microsoft	30522
NAD	33003
Onkyo	30503, 32900, 32910
Panasonic	30490, 30503, 33005
Philco	33002
Philips	30503, 30539, 32056, 33002, 33007, 33016
Pioneer	30631, 33000, 33017
Polk Audio	30539
Presidian	33002
Proscan	30522
RCA	30522
Samsung	30490, 30573, 33001, 32329, 32489, 32556
Sharp	33002



<b>DVD</b>	
Sony	30864, 31033, 31633, 33004
Sylvania	33002
Symphonic	33002
Technics	30490
Toshiba	30503, 32277
Urban Concepts	30503
Xbox	30522
Yamaha	30490, 30539, 30817, 33011
Zenith	30503, 33003

<b>DVD High Definition (Blu-Ray)</b>	
Denon	33010
Insignia	33002, 33014, 33025
Integra	32900
JVC	32365
LG	33003
Magnavox	33002
Marantz	33013, 33015
NAD	33024
Olevia	33012
Onkyo	32900, 32910
Oppo	33021
Panasonic	33005
Philips	33007, 33016
Pioneer	33000, 33017
Samsung	33001
Sharp	33009
Sony	33004, 33026, 33008
Sylvania	33002
Viore	33022
Vizio	33023
Yamaha	33011

<b>DVD-R</b>	
Accurian	33002
Funai	33002
Go Video	33003
LG	33003
Magnavox	33002
Panasonic	30490
Pioneer	30631
RCA	30522
Samsung	30490
Sharp	33002
Sony	31033
Sylvania	33002
Toshiba	32277
Zenith	33003

<b>TV/DVD Combination</b>	
Akai	11675

<b>TV/DVD Combination</b>	
Dynex	12049, 12184
Emerson	11394, 11864, 11963, 33002
ESA	11963
Funai	11963
GFM	11963
Insignia	11963, 12002, 12049, 12417
LG	11423
Magnavox	11963
Polaroid	11523, 12002
RCA	12002, 12187
Sharp	10818
Sylvania	11394, 11864, 11963, 33002
Toshiba	11524, 12006

## Maintaining

To clean this receiver, wipe with a soft, dry cloth. If the surfaces are extremely dirty, use a soft cloth dipped in a soap and water solution or a weak detergent solution.

- Never use alcohol, paint thinner, or benzene to clean this receiver.
- Before using a chemically treated cloth, read the instructions that came with the cloth carefully.

## Troubleshooting

If a problem occurs, run through the following table before contacting Insignia.

If the problem persists, attempt to solve it by switching the receiver off and on again. If this fails to resolve the problem, contact Insignia. Under no circumstances should you attempt to repair the receiver yourself as this could void the warranty.

To reset the receiver to its factory defaults, turn it on and, while holding down VCR/DVR, press **ON/STANDBY**. **Clear** appears on the display and the receiver enters Standby mode.

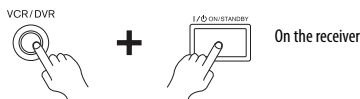

Note that resetting the receiver will delete your radio presets and custom settings.

To reset the remote control to its factory defaults, while holding down **RECEIVER**, press and hold down **AUDIO** until the remote indicator lights (about three seconds). Within 30 seconds, press **RECEIVER** again.

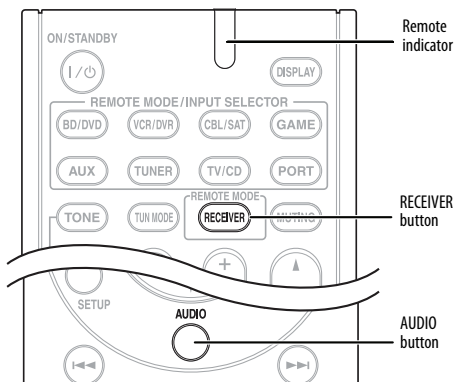

### Notes

- The receiver contains a microcomputer for signal processing and control functions. In rare situations, severe interference, noise from an external source, or static electricity may cause it to lockup. If this happens, unplug the power cord from the wall outlet, wait at least five seconds, and then plug it back in again.
- Insignia is not responsible for damages (such as CD rental fees) due to unsuccessful recordings caused by the unit's malfunction.
- Before disconnecting the power cord from the wall outlet, set the receiver to Standby.

Category	Problem/Possible Solution
<b>AUDIO Problems</b>	
No power	<ul style="list-style-type: none"> <li>• Connect the cord securely.</li> <li>• Check the outlet using a lamp or another appliance.</li> </ul>
The STANDBY indicator flashes red	<ul style="list-style-type: none"> <li>• Remove the power cord from the wall outlet immediately. Disconnect all speaker cables and input sources, and then leave the receiver with its power cord disconnected for one hour. After that, reconnect the power cord and set the volume to maximum. If the receiver stays on, set then the volume to minimum, disconnect the power cord, and reconnect your speakers and input sources. If the receiver turns off when you set the volume to maximum, disconnect the power cord, and contact your Insignia dealer.</li> </ul>
No sound	<ul style="list-style-type: none"> <li>• Make sure that the digital input source is selected properly.</li> <li>• Make sure that all audio connecting plugs are pushed in all the way.</li> <li>• Make sure that the inputs and outputs of all components are connected properly.</li> <li>• Make sure that the polarity of the speaker cables is correct, and that the bare wires are in contact with the metal part of each speaker terminal.</li> <li>• Make sure that the input source is properly selected.</li> <li>• Make sure that the speaker cables are not shorting.</li> <li>• Check the volume. The receiver is designed for home theater enjoyment. It has a wide volume range, allowing precise adjustment.</li> <li>• If the <b>MUTING</b> indicator is flashing on the display, press the remote control <b>MUTING</b> button to unmute the receiver.</li> <li>• While a pair of headphones is connected to the PHONES jack, no sound is output by the speakers.</li> <li>• If there is no sound from a DVD player connected to <b>HDMI IN</b> jack, check the DVD player's output settings, and be sure to select a supported audio format.</li> <li>• Check the digital audio output setting on the connected device. On some game consoles, such as those that support DVD, the default setting is off.</li> <li>• With some DVD-Video discs, you need to select an audio output format from a menu.</li> <li>• If your turntable uses an MC cartridge, you must connect an MC head amp, or an MC transformer.</li> <li>• Make sure that none of the connecting cables are bent, twisted, or damaged.</li> <li>• Not all listening modes use all speakers.</li> <li>• Specify the speaker distances and adjust the individual speaker levels.</li> <li>• The input signal format is set to <b>PCM</b> or <b>DTS</b>. Set it to <b>Auto</b>.</li> </ul>
Only the front speakers produce sound	<ul style="list-style-type: none"> <li>• When the Stereo or Mono listening mode is selected, only the front speakers and subwoofer produce sound.</li> <li>• Check the Speaker Configuration.</li> </ul>
Only the center speaker produces sound	<ul style="list-style-type: none"> <li>• If you use the Dolby Pro Logic II Movie, Dolby Pro Logic II Music, or Dolby Pro Logic II Game listening mode with a mono source, such as an AM radio station or mono TV program, the sound is concentrated in the center speaker.</li> <li>• Make sure the speakers are configured correctly.</li> </ul>
The surround speakers produce no sound	<ul style="list-style-type: none"> <li>• When the T-D (Theater-Dimensional), Stereo, or Mono listening mode is selected, the surround speakers produce no sound.</li> <li>• Depending on the source and current listening mode, not much sound may be produced by the surround speakers. Try selecting another listening mode.</li> <li>• Make sure the speakers are configured correctly.</li> </ul>
The center speaker produces no sound	<ul style="list-style-type: none"> <li>• When the Stereo or Mono listening mode is selected, the center speaker produces no sound.</li> <li>• Make sure the speakers are configured correctly.</li> </ul>
The subwoofer produces no sound	<ul style="list-style-type: none"> <li>• When you play source material that contains no information in the LFE channel, the subwoofer produces no sound.</li> <li>• Make sure the speakers are configured correctly.</li> </ul>

Category	Problem/Possible Solution
There's no sound with a certain signal format	<ul style="list-style-type: none"> <li>Check the digital audio output setting on the connected device. On some game consoles, such as those that support DVD, the default setting is off.</li> <li>With some DVD-Video discs, you need to select an audio output format from a menu.</li> <li>Depending on the input signal, some listening modes cannot be selected.</li> </ul>
No 5.1 playback	<ul style="list-style-type: none"> <li>You can not always select all of the listening modes, depending on the number of the speakers connected.</li> </ul>
The volume cannot be set to 79	<ul style="list-style-type: none"> <li>Check to see if a maximum volume has been set.</li> <li>After the volume level of each individual speaker has been adjusted, the maximum volume may be reduced.</li> <li>When the levels of each speaker have been adjusted, the maximum possible volume may be reduced.</li> </ul>
Noise can be heard	<ul style="list-style-type: none"> <li>Using cable ties to bundle audio cables with power cords, speaker cables, and so on may degrade the audio performance, so don't do it.</li> <li>An audio cable may be picking up interference. Try repositioning your cables.</li> </ul>
The Late Night function does not work	<ul style="list-style-type: none"> <li>Make sure that the source material is Dolby Digital, Dolby Digital Plus, and Dolby TrueHD.</li> </ul>
DTS signal problems	<ul style="list-style-type: none"> <li>When DTS program material ends and the DTS bitstream stops, the receiver remains in DTS listening mode and the DTS indicator remains on. This is to prevent noise when you use the pause, fast forward, or fast reverse function on your player. If you switch your player from DTS to PCM, because the receiver does not switch formats immediately, you may not hear any sound, in which case you should stop your player for about three seconds, and then resume playback.</li> <li>With some CD and LD players, you won't be able to playback DTS material properly even though your player is connected to a digital input on the receiver. This is usually because the DTS bitstream has been processed (for example, output level, sampling rate, or frequency response changed) and the receiver does not recognize it as a genuine DTS signal. In such cases, you may hear noise.</li> <li>When playing DTS program material, using the pause, fast forward, or fast reverse function on your player may produce a short audible noise. This is not a malfunction.</li> </ul>
The beginning of audio received by an HDMI IN can not be heard	<ul style="list-style-type: none"> <li>Since it takes longer to identify the format of an HDMI signal than it does for other digital audio signals, audio output may not start immediately.</li> </ul>
<b>VIDEO Problems</b>	
No picture	<ul style="list-style-type: none"> <li>Make sure that all video connecting plugs are pushed in all the way.</li> <li>Make sure that each video component is properly connected.</li> <li>If the video source is connected to a component video input, you must assign that input to an input selector, and your TV must be connected to COMPONENT VIDEO MONITOR OUT.</li> <li>If the video source is connected to a composite video input, your TV must be connected to the corresponding composite video output.</li> <li>If the video source is connected to an HDMI input, you must assign that input to an input selector, and your TV must be connected to the HDMI OUT.</li> <li>On your TV, make sure that the video input to which the receiver is connected is selected.</li> </ul>
There is no picture from a source connected to an HDMI IN	<ul style="list-style-type: none"> <li>Reliable operation with an HDMI-to-DVI adapter is not guaranteed. In addition, video signals from a PC are not guaranteed.</li> </ul>
The on-screen menus do not appear	<ul style="list-style-type: none"> <li>On your TV, make sure that the video input to which the receiver is connected is selected.</li> <li>When the receiver doesn't connect TV with HDMI, onscreen menus are not displayed.</li> </ul>

Category	Problem/Possible Solution
<b>TUNER Problems</b>	
Reception is noisy, FM stereo reception is noisy, or the FM STEREO indicator does not light	<ul style="list-style-type: none"> <li>Relocate your antenna.</li> <li>Move the receiver away from your TV or computer.</li> <li>Listen to the station in mono.</li> <li>When listening to an AM station, operating the remote control may cause noise.</li> <li>Passing cars and airplanes can cause interference.</li> <li>Concrete walls weaken radio signals.</li> <li>If nothing improves the reception, install an outdoor antenna.</li> </ul>
<b>REMOTE CONTROL Problems</b>	
The remote control does not work	<ul style="list-style-type: none"> <li>Before operating this unit, be sure to press <b>RECEIVER</b>.</li> <li>Make sure that the batteries are installed with the correct polarity.</li> <li>Install new batteries. Don't mix different types of batteries, or old and new batteries.</li> <li>Make sure that the remote control is not too far away from the receiver, and that there's no obstruction between the remote control and the receiver's remote control sensor.</li> <li>Make sure that the A receiver is not subjected to direct sunshine or inverter-type fluorescent lights. Relocate if necessary.</li> <li>If the receiver is installed in a rack or cabinet with colored-glass doors, the remote control may not work reliably when the doors are closed.</li> <li>Make sure you've selected the correct remote control mode.</li> <li>Make sure you've entered the correct remote control code.</li> <li>Make sure to set the same ID on both the receiver and remote control.</li> </ul>
Cannot control other components	<ul style="list-style-type: none"> <li>Make sure that you have selected the correct remote control mode.</li> <li>If you cannot operate it, you need to enter the appropriate remote control code.</li> </ul>
<b>RECORDING Problems</b>	
Cannot record	<ul style="list-style-type: none"> <li>On your recorder, make sure the correct input is selected.</li> <li>To prevent signal loops and damage to the receiver, input signals are not fed through to outputs with the same name (for example, VCR/DVR IN to VCR/ DVR OUT).</li> </ul>
<b>MISCELLANEOUS Problems</b>	
The sound changes when I connect my headphones	<ul style="list-style-type: none"> <li>When a pair of headphones is connected, the listening mode is set to Stereo, unless it's already set to Stereo, Mono, or Direct.</li> </ul>
How do I change the language of a multiplex source	<ul style="list-style-type: none"> <li>Use the <b>Multiplex</b> setting on the <i>Audio Adjust</i> menu to select <b>Main</b> or <b>Sub</b>.</li> </ul>
The following settings can be made for the composite video inputs	<p>You must use the buttons on the unit to make these settings.</p> <ol style="list-style-type: none"> <li>While holding down the input selector button for the input source that you want to set, press <b>SETUP</b>.</li> <li>Use ◀/▶ to change the setting.</li> <li>Press the input selector button for the input source that you want to set when you have finished.</li> </ol> <p><b>Video Attenuation</b></p> <p>This setting can be made for the BD/DVD, VCR/DVR, CBL/SAT, GAME, or AUX input.</p> <p>If you have a games console connected to the composite video input, and the picture is not very clear, you can attenuate the gain.</p> <ul style="list-style-type: none"> <li><b>Video ATT-0:</b> (default).</li> <li><b>Video ATT-2:</b> Gain is reduced by 2 dB.</li> </ul>

## Specifications

### Note

Design and specifications are subject to change without notice.

### Amplifier section

Element	Specification
<b>Rated output power All channels</b>	110 watts minimum continuous power per channel, 6 ohms, at 1 kHz with a maximum total harmonic distortion of 1%.
<b>THD (Total Harmonic Distortion)</b>	0.08% (1 kHz, 1 W)
<b>Input sensitivity and impedance</b>	200 mV/47 kohms (LINE)
<b>Output level and impedance</b>	200 mV/2.2 kohms (REC OUT)
<b>Frequency response</b>	20 Hz - 50 kHz/+1 dB - 3 dB (DSP bypass)
<b>Tone control</b>	±10 dB, 50 Hz (BASS) ±10 dB, 20 kHz (TREBLE)
<b>Signal to Noise ratio</b>	90 dB (LINE, IHF-A)
<b>Speaker impedance</b>	6 ohms - 16 ohms

### Video section

Element	Specification
<b>Input sensitivity/ Output level and impedance</b>	1 Vp-p/75 ohms (Component) 0.7 Vp-p/75 ohms (Component PB/CB, PR/CR) 1 Vp-p/75 ohms (Composite)
<b>Component video frequency response</b>	5 Hz - 100 MHz/±0 dB, - 3 dB

### Tuner section

Element	Specification
<b>FM tuning frequency range</b>	87.5 MHz - 107.9 MHz
<b>AM tuning frequency range</b>	530 kHz - 1710 kHz
<b>Preset channels</b>	40

### General section

Element	Specification
<b>Power supply</b>	AC 120 V, 60 Hz
<b>Power consumption</b>	3.3 A
<b>Standby power consumption</b>	0.2 W
<b>Dimensions (W x H x D)</b>	17-1/8" x 5-15/16" x 13-3/8" 435 mm x 150.5 mm x 339 mm
<b>Weight</b>	17.6 lbs (8 kg)
<b>HDMI</b>	

Element	Specification
<b>Input</b>	IN1, IN2, IN3
<b>Output</b>	OUT
<b>Video Resolution</b>	1080p
<b>Audio Format</b>	Dolby TrueHD, DTS Master Audio, DVD-Audio, DSD
<b>Supported</b>	CEC, 3D, ARC, Deep Color, x.v.Color, LipSync
<b>VIDEO INPUTS</b>	
<b>Component</b>	IN 1, IN 2
<b>Composite</b>	BD/DVD, VCR/DVR, CBL/SAT, GAME, AUX
<b>VIDEO OUTPUTS</b>	
<b>Component</b>	OUT
<b>Composite</b>	MONITOR OUT, VCR/DVR
<b>AUDIO INPUTS</b>	
<b>Digital</b>	Optical: 2 Coaxial: 1
<b>Analog</b>	BD/DVD, VCR/DVR, CBL/SAT, GAME, TV/CD, AUX
<b>AUDIO OUTPUTS</b>	
<b>Analog</b>	VCR/DVR,
<b>Subwoofer Pre Output</b>	<sup>1</sup>
<b>Speaker Outputs</b>	Front (L, R), C, SL, SR
<b>Phones</b>	1 (6.3 ø)

### Subwoofer

Element	Specification
<b>Type</b>	Bass-reflex
<b>Input sensitivity/ Impedance</b>	140 mV/20 kohm
<b>Maximum output power</b>	120 W (RMS), driven into 4 ohms
<b>Frequency response</b>	25 Hz-150 Hz
<b>Cabinet capacity</b>	1.34 cubic feet (38L)
<b>Dimensions (W x H x D)</b>	12-1/2" x 18-1/8" x 15-11/16" (317.5 mm x 460 mm x 398 mm)
<b>Weight</b>	24.3 lbs (11 kg)
<b>Drivers unit</b>	10" (25 cm) cone
<b>Power supply</b>	AC 120 V, 60 Hz
<b>Power consumption</b>	163 W
<b>Other</b>	Auto standby function

### Front speakers

Element	Specification
<b>Type</b>	2-way bass-reflex
<b>Impedance</b>	6 ohm

Element	Specification
Maximum input power	120 W
Sensitivity	81.5 dB/W/m
Frequency response	60 Hz-50 kHz
Crossover frequency	4 kHz
Cabinet capacity	0.049 cubic feet (1.4 L)
Dimensions (W x H x D)	5-5/16" x 8-11/16" x 4-3/16" (135 mm x 220 mm x 107 mm)
Weight	3.3 lbs (1.5 kg)
Drivers unit	4" (10 cm) cone (woofer) 1" (2.5 cm) balanced dome (tweeter)
Terminal	Spring-type, color coded
Keyhole slot	1
Grill	Fixed
Other	Magnetic shielding

### Center speaker

Element	Specification
Type	2-way bass-reflex
Impedance	6 ohm
Maximum input power	120 W
Sensitivity	85 dB/W/m
Frequency response	65 Hz-50 kHz
Crossover frequency	6 kHz
Cabinet capacity	0.081 cubic feet (2.3 L)
Dimensions (W x H x D)	13-9/16" x 4-1/2" x 4-5/8" (344.5 mm x 114.5 mm x 118 mm)
Weight	4.6 lbs (2.1 kg)
Drivers unit	3-1/4" (8 cm) cone (woofer) X 2 1" (2.5 cm) balanced dome (tweeter)
Terminal	Spring-type, color coded
Keyhole slot	2
Grill	Fixed
Other	Magnetic shielding

### Surround speakers

Element	Specification
Type	Full-range, closed box
Impedance	6 ohm
Maximum input power	120 W
Sensitivity	81.5 dB/W/m
Frequency response	85 Hz-20 kHz
Cabinet capacity	0.028 cubic feet (0.8 L)
Dimensions (W x H x D)	4-1/2" x 7-11/16" x 3-11/16" (115 mm x 195.5 mm x 93 mm)
Weight	2.0 lbs (0.9 kg)
Drivers unit	3-1/4" (8 cm) cone
Terminal	Spring-type, color coded
Keyhole slot	1
Grill	Fixed

# Legal notices

## FCC Part 15

This device complies with Part 15 of the FCC Rules. Operation of this product is subject to the following two conditions: (1) this device may not cause harmful interference, and (2) this device must accept any interference received, including interference that may cause undesired operation.

This equipment has been tested and found to comply within the limits for a class B digital device, pursuant to Part 15 of the FCC Rules. These limits are designed to provide reasonable protection against harmful interference in a residential installation. This equipment generates, uses, and can radiate radio frequency energy and, if not installed and used in accordance with the instructions, may cause harmful interference to radio communications. However, there is no guarantee that interference will not occur in a particular installation. If this equipment does cause harmful interference to radio or television reception, which can be determined by turning the equipment off and on, the user is encouraged to try to correct the interference by one or more of the following measures:

- Reorient or relocate the receiving antenna.
- Increase the separation between the equipment and receiver.
- Connect the equipment into an outlet on a circuit different from that to which the receiver is connected.
- Consult the dealer or an experienced technician for help.

## FCC warning

Changes or modifications not expressly approved by the party responsible for compliance with the FCC Rules could void the user's authority to operate this equipment.

## Canada ICES-003 statement

This Class B digital apparatus complies with Canadian ICES-003.

## Dolby TrueHD



Manufactured under license from Dolby Laboratories. "Dolby", "Pro Logic" and the double-D symbol are trademarks of Dolby Laboratories.

## DTS HD™



Manufactured under license under U.S. Patent #'s: 5,451,942; 5,956,674; 5,974,380; 5,978,762; 6,226,616; 6,487,535; 7,212,872; 7,333,929; 7,392,195; 7,272,567 & other U.S. and worldwide patents issued & pending. DTS is a registered trademark and the DTS logos, Symbol are trademarks of DTS, Inc.  
©1996-2008 DTS, Inc. All Rights Reserved.

## HDMI®



"HDMI, the HDMI Logo, and High-Definition Multimedia Interface are trademarks or registered trademarks of HDMI Licensing LLC in the United States and other countries."

## AUDYSSEY 2EQ™



Manufactured under license from Audyssey Laboratories™. U.S. and foreign patents pending. Audyssey 2EQ™, Audyssey Dynamic Volume™, and Audyssey Dynamic EQ® are registered trademarks and trademarks of Audyssey Laboratories.



## One-year limited warranty

Insignia Products ("Insignia") warrants to you, the original purchaser of this new **NS-HTIB51A** ("Product"), that the Product shall be free of defects in the original manufacture of the material or workmanship for a period of one (1) year from the date of your purchase of the Product ("Warranty Period"). This Product must be purchased from an authorized dealer of Insignia brand products and packaged with this warranty statement. This warranty does not cover refurbished Product. If you notify Insignia during the Warranty Period of a defect covered by this warranty that requires service, terms of this warranty apply.

### How long does the coverage last?

The Warranty Period lasts for 1 year (365 days) from the date you purchased the Product. The purchase date is printed on the receipt you received with the Product.

### What does this warranty cover?

During the Warranty Period, if the original manufacture of the material or workmanship of the Product is determined to be defective by an authorized Insignia repair center or store personnel, Insignia will (at its sole option): (1) repair the Product with new or rebuilt parts; or (2) replace the Product at no charge with new or rebuilt comparable products or parts. Products and parts replaced under this warranty become the property of Insignia and are not returned to you. If service of Products or parts are required after the Warranty Period expires, you must pay all labor and parts charges. This warranty lasts as long as you own your Insignia Product during the Warranty Period. Warranty coverage terminates if you sell or otherwise transfer the Product.

### How to obtain warranty service?

If you purchased the Product at a retail store location, take your original receipt and the Product to the store you purchased it from. Make sure that you place the Product in its original packaging or packaging that provides the same amount of protection as the original packaging. If you purchased the Product from an online web site, mail your original receipt and the Product to the address listed on the web site. Make sure that you put the Product in its original packaging or packaging that provides the same amount of protection as the original packaging.

To obtain in-home warranty service for a television with a screen 25 inches or larger, call 1-888-BESTBUY. Call agents will diagnose and correct the issue over the phone or will have an Insignia-approved repair person dispatched to your home.

### Where is the warranty valid?

This warranty is valid only to the original purchaser of the product in the United States, Canada, and Mexico.

### What does the warranty not cover?

This warranty does not cover:

- Customer instruction
- Installation
- Set up adjustments
- Cosmetic damage
- Damage due to acts of God, such as lightning strikes
- Accident
- Misuse
- Abuse
- Negligence
- Commercial use
- Modification of any part of the Product, including the antenna
- Plasma display panel damaged by static (non-moving) images applied for lengthy periods (burn-in).

This warranty also does not cover:

- Damage due to incorrect operation or maintenance
- Connection to an incorrect voltage supply
- Attempted repair by anyone other than a facility authorized by Insignia to service the Product
- Products sold as is or with all faults
- Consumables, such as fuses or batteries

- Products where the factory applied serial number has been altered or removed

REPAIR REPLACEMENT AS PROVIDED UNDER THIS WARRANTY IS YOUR EXCLUSIVE REMEDY. INSIGNIA SHALL NOT BE LIABLE FOR ANY INCIDENTAL OR CONSEQUENTIAL DAMAGES FOR THE BREACH OF ANY EXPRESS OR IMPLIED WARRANTY ON THIS PRODUCT, INCLUDING, BUT NOT LIMITED TO, LOST DATA, LOSS OF USE OF YOUR PRODUCT, LOST BUSINESS OR LOST PROFITS. INSIGNIA PRODUCTS MAKES NO OTHER EXPRESS WARRANTIES WITH RESPECT TO THE PRODUCT, ALL EXPRESS AND IMPLIED WARRANTIES FOR THE PRODUCT, INCLUDING, BUT NOT LIMITED TO, ANY IMPLIED WARRANTIES OF AND CONDITIONS OF MERCHANTABILITY AND FITNESS FOR A PARTICULAR PURPOSE, ARE LIMITED IN DURATION TO THE WARRANTY PERIOD SET FORTH ABOVE AND NO WARRANTIES, WHETHER EXPRESS OR IMPLIED, WILL APPLY AFTER THE WARRANTY PERIOD. SOME STATES, PROVINCES AND JURISDICTIONS DO NOT ALLOW LIMITATIONS ON HOW LONG AN IMPLIED WARRANTY LASTS, SO THE ABOVE LIMITATION MAY NOT APPLY TO YOU. THIS WARRANTY GIVES YOU SPECIFIC LEGAL RIGHTS, AND YOU MAY ALSO HAVE OTHER RIGHTS, WHICH VARY FROM STATE TO STATE OR PROVINCE TO PROVINCE.

Contact Insignia:

For customer service please call 1-877-467-4289  
www.insigniaproducts.com

Distributed by Best Buy Purchasing, LLC  
7601 Penn Avenue South, Richfield, Minnesota, U.S.A.  
55423-3645

© 2010 BBY Solutions, Inc.

All rights reserved. INSIGNIA is a trademark of BBY Solutions, Inc. Registered in some countries. All other products and brand names are trademarks of their respective owners.



[www.insigniaproducts.com](http://www.insigniaproducts.com) (877) 467-4289

Distributed by Best Buy Purchasing, LLC  
7601 Penn Avenue South, Richfield, MN USA 55423-3645  
© 2010 BBY Solutions, Inc.

All rights reserved. INSIGNIA is a trademark of BBY Solutions, Inc. Registered in some countries.  
All other products and brand names are trademarks of their respective owners.



## Free Manuals Download Website

<http://myh66.com>

<http://usermanuals.us>

<http://www.somanuals.com>

<http://www.4manuals.cc>

<http://www.manual-lib.com>

<http://www.404manual.com>

<http://www.luxmanual.com>

<http://aubethermostatmanual.com>

Golf course search by state

<http://golfingnear.com>

Email search by domain

<http://emailbydomain.com>

Auto manuals search

<http://auto.somanuals.com>

TV manuals search

<http://tv.somanuals.com>