

# DENON

## REMOTE CONTROL UNIT

# RC-8000

## OPERATING INSTRUCTIONS MODE D'EMPLOI

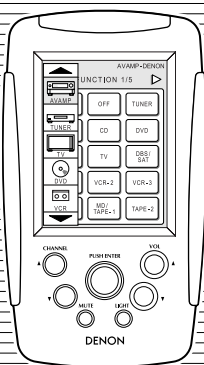

FOR ENGLISH READERS PAGE 2 ~ PAGE 33  
POUR LES LECTEURS FRANCAIS PAGE 34 ~ PAGE 65

"SERIAL NO. \_\_\_\_\_  
PLEASE RECORD UNIT SERIAL NUMBER ATTACHED TO THE REAR OF THE CABINET FOR  
FUTURE REFERENCE"

"NO. DE SERIE \_\_\_\_\_  
PRIERE DE NOTER LE NUMERO DE SERIE DE L'APPAREIL INSCRIT A L'ARRIERE DU  
COFFRET DE FAÇON A POUVOIR LE CONSULTER EN CAS DE PROBLEME."

- **We greatly appreciate your purchase of this unit.**
- **To be sure you take maximum advantage of all the features this unit has to offer, read these instructions carefully and use the set properly. Be sure to keep this manual for future reference should any questions or problems arise.**

This device complies with Part 15 of the FCC Rules and Industry CANADA RSS210.

Operation is subject to the following two conditions: (1) This device may not cause harmful interference, and (2) this device must accept any interference received, including interference that may cause undesired operation.

This Class B digital apparatus meets all requirements of the Canadian Interference-Causing Equipment Regulations.

Cet appareil numérique de la classe B respecte toutes les exigences du Règlement sur le matériel brouilleur du Canada.

**TABLE OF CONTENTS**

<b>1</b>	Features.....	3	<b>5</b>	Other Registerable Devices .....	25
<b>2</b>	Before Using .....	3	<b>6</b>	Customizing	
<b>3</b>	Names of Parts.....	4		(setting the operating environment).....	26~31
<b>4</b>	Operation .....	4~24		Editing the icon display section .....	26~28
	Introduction .....	4, 5		[1] Adding devices .....	26
	[1] Turning on the liquid crystal display.....	4		[2] Deleting devices .....	26
	[2] Adjusting the brightness of the liquid crystal display .....	4		[3] Changing the positions of devices in the icon display section .....	27
	[3] Adjusting the touch panel.....	5		[4] Registering device names .....	28
	[4] Basic operation of the liquid crystal display .....	5, 6		Customizing the Buttons.....	29, 30
	Operating preset devices.....	6~10		[1] Adding buttons .....	29
	Preset Memory .....	10~17		[2] Deleting buttons .....	29
	[1] Changing the preset memory of preset devices .....	12		[3] Moving buttons .....	29, 30
	[2] Adding new devices .....	13		[4] Changing button names .....	30
	[3] Operating devices for which the preset memory is set.....	14~17	<b>7</b>	User Menu .....	31
	Learning Function .....	18~19		One-button Search Function .....	31, 32
	[1] Using the learning function .....	18, 19		[1] Using the one-button search function....	31, 32
	[2] Inputting button names .....	19	<b>8</b>	RF Transmission Function .....	32
	System Call Function .....	20~22	<b>9</b>	Factory Default Settings.....	32
	[1] System call buttons .....	20	<b>10</b>	Specifications .....	32
	[2] Storing system call signals .....	20, 21	<b>11</b>	Cautions on Use .....	33
	[3] Editing registered system call settings ..	21, 22	<b>12</b>	Troubleshooting .....	33
	[4] Deleting registered system call settings .....	22			
	[5] Sending system call signals.....	22			
	[6] Changing the names of system call settings.....	22			
	Making the Various Settings .....	23, 24			
	[1] Backing up the current settings .....	23			
	[2] Making the sound settings.....	23			
	[3] Setting the liquid crystal display's auto off time .....	23			
	[4] Setting the back light's auto off time .....	24			
	Resetting .....	24			

## 1 FEATURES

The RC-8000 can be used for integrated control of remote controllable devices connected to an AV amplifier (for example TV sets and DVD players) as well as remote control compatible peripheral devices (for example lighting equipment and power screens).

Icons are registered for 20 types of devices, and presettings are available for 14 of these device types. (Of the device types for which presettings are registered, six are for Denon products only).

Devices for which no presettings are registered can be operated using the learning function.

In addition, system call settings can be made to operate multiple devices at once in a "macro" sequence.

### 1. Large liquid crystal touch display

320 x 240 dot liquid crystal display with EL back light.

### 2. Preset memory function

Easy memory presetting thanks to a preset memory search function (1-button search).

### 3. System call function

Up to 20 system call settings (10 codes per setting) can be registered.

Delay times can be set between the transmission codes.

### 4. Customizing function

Up to 23 extra devices to be used can be registered additionally, and buttons can be moved and their names changed for easier use.

### 5. User menu function

The user menu settings can be used to register frequently used buttons on a single page and this page can always be displayed first.

### 6. User backup function

Customized settings can be backed up so that set data is not lost.

### 7. Learning function

The remote control signals of your devices can be stored ("learned") in the RC-8000, so all your equipment can be operated using the RC-8000. Approximately 200 codes can be learned.

### 8. RF transmission function (only when the RC-8000 and RC-8001ST are used in combination)

RF transmission is possible when the RC-8000 is used in combination with the RC-8001ST.

### 9. Charging function (only when the RC-8000 and RC-8001ST are used in combination)

When using the nickel cadmium battery included with the RC-8001ST, the RC-8000 can be charged on the RC-8001ST.

### 10. USB update function

In the future the RC-8000 will allow customizing and updating of remote control signals on a personal computer through connection to the computer using the USB connector.

(A separately available PC application program is required.)

## 2 BEFORE USING

Loading the LR6 (AA size) alkaline batteries

- Slide the battery cover on the rear of the RC-8000 to remove it.

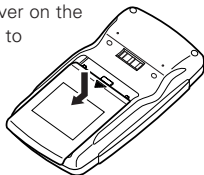

- Insert the included alkaline batteries, being careful to do so in the proper direction.

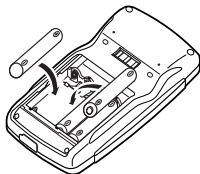

- Close the battery cover.

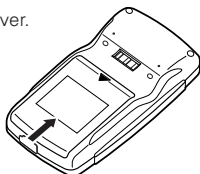

### Notes on Batteries

- Use LR6 (AA size) alkaline batteries in the remote control unit.
  - The batteries should be replaced with new ones approximately once a year, though this depends on the frequency of usage.
  - Even if less than a year has passed, replace the batteries with new ones if the set does not operate even when the remote control unit is operated nearby the set. (The included battery is only for verifying operation. Replace it with a new battery as soon as possible.)
  - When inserting the batteries, be sure to do so in the proper direction, following the "⊕" and "⊖" marks in the battery compartment.
  - To prevent damage or leakage of battery fluid:
    - Do not use a new battery together with an old one.
    - Do not use two different types of batteries.
    - Do not short-circuit, disassemble, heat or dispose of batteries in flames.
  - Remove the batteries from the remote control unit when you do not plan to use it for an extended period of time.
  - If the battery fluid should leak, carefully wipe the fluid off the inside of the battery compartment and insert new batteries.
  - When replacing the batteries, have the new batteries ready and insert them as quickly as possible.
  - The learned remote control signals may be cleared if no batteries are in the remote control unit for about 5 seconds.
- The factory-installed codes are in permanent memory, however.

### 3 NAMES OF PARTS

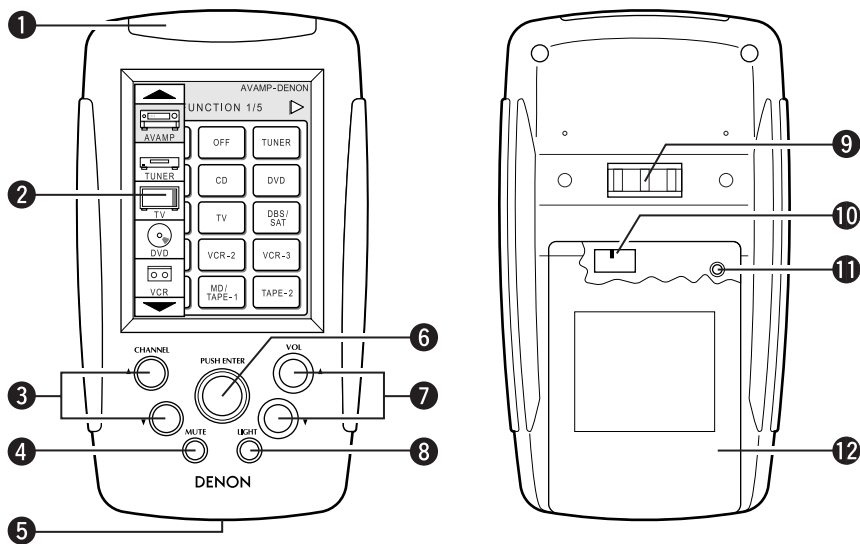

- 1 Transmitter
- 2 Touch panel
- 3 CHANNEL up/down buttons
- 4 MUTE button
- 5 USB terminal
- 6 JOG stick
- 7 VOL. (volume) up/down buttons
- 8 LIGHT (back light) button
- 9 Battery charging contacts
- 10 RF frequency selector switch
- 11 Reset button
- 12 Battery cover

**NOTE:**

The USB terminal is a terminal that will be used in the future to update the microprocessor program, etc.

### 4 OPERATION

#### Introduction

**[1] Turning on the liquid crystal display**

After loading the batteries, turn on the liquid crystal display. Turn on the liquid crystal display by lightly touching the touch panel or by pressing the LIGHT button. (The back light does not turn on when the touch panel is pressed.) By default the liquid crystal display is set to remain on for 10 seconds.

The display time can be adjusted, so set "Setting the liquid crystal display's auto off time" and "Setting the back light's auto off time" to times that allow easy operation, referring to page 23 and 24.

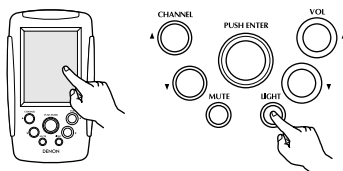

**[2] Adjusting the brightness of the liquid crystal display**

Press the VOL. ▲ (up) and ▼ (down) buttons while pressing the LIGHT button to adjust the brightness of the liquid crystal display. The display gets denser when the VOL. ▲ (up) button is pressed, lighter when the VOL. ▼ (down) button is pressed.

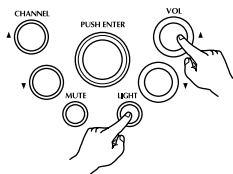

**[3] Adjusting the touch panel**

Adjust the touch panel so that keys on the touch panel can be operated with accuracy.

Press "SETUP" in the icon display section for at least 3 seconds. The setup screen appears.

Use the ◀ and ▶ buttons in the page display section to display page 4/4.

Press the "Calibration" button on the setup screen. The touch panel adjustment ("Calibration") screen appears.

Touch the intersection points of the "+" marks within the circles in the four corners of the touch panel adjustment screen using an object with a soft, narrow tip (such as a cotton swab). The display switches to a half-tone dot mesh.

The touch panel is adjusted and the setup screen reappears automatically.

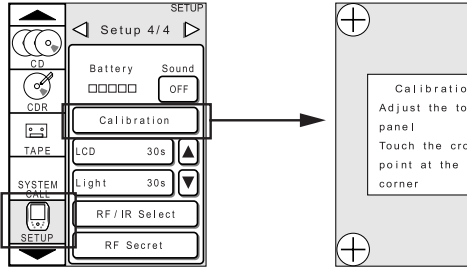

**NOTE:**

The touch panel adjustment may go off due to changes in temperature during use. If the adjustment is far off and the touch panel is difficult to operate, readjust it. Also adjust the touch panel after replacing the batteries.

**[4] Basic operation of the liquid crystal display**

With the RC-8000, remote control signals are sent by gently touching buttons displayed on the liquid crystal display.

When icons or buttons are touched lightly, operation is notified by a beep and the display of that part switches to a half-tone dot mesh. To turn off the beep, refer to "Making the sound settings" on page 23.

Use the procedure described below to display the device to be operated and its buttons.

- 1 If the liquid crystal display is off, either gently touch it or press the "LIGHT" button to turn it on.
- 2 Press the JOG stick's "ENTER" button to display icon display section A. (Icon display section A turns on and off each time the JOG stick is pressed.)
- 3 While icon display section A is displayed, press the ▲ and ▼ buttons in display section A to display the icon for the device you want to operate. The displayed icons scroll five icons at a time each time the ▲ and ▼ button is pressed.
- 4 Select the icon for the device you want to operate and press that icon section.
- 5 The operating buttons for the selected device appear in page display section B.
- 6 Press the ◀ and ▶ buttons in the page display section to display the page containing the button you want to operate.
- 7 Press the button you want to operate. The remote control signal is sent and the selected device is operated.

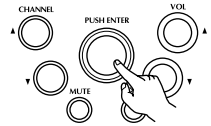

Icon display section (A)

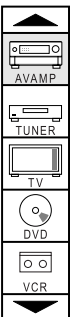

Page display section (B)

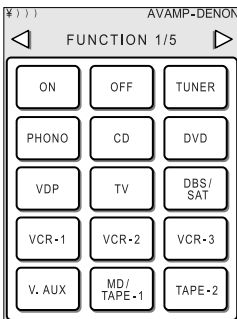

Actual display screen examples  
screen while icons are displayed      screen while pages are displayed

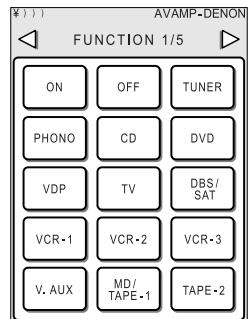
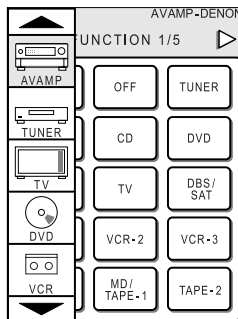

## Other operations

When icon display section A is displayed, the device icons can also be scrolled by tilting the JOG stick forward and backward. The half-tone dot mesh display moves and the page display section also changes.

When the JOG stick is pressed and the ENTER button is pressed, the icon display section turns off, the page display section is displayed and buttons can be operated.

By default, the following 10 icons (8 device types) are displayed in icon display section A.

- \* Add devices not displayed by default using the procedure described in section "Adding devices" on page 26. (A maximum of 23 device types can be registered.)

- |                                 |                           |
|---------------------------------|---------------------------|
| 1 AV AMP (AV amplifier)         | 6 CD (CD player)          |
| 2 TUNER (AM/FM tuner)           | 7 CDR (CD recorder)       |
| 3 TV                            | 8 TAPE (tape deck)        |
| 4 DVD (DVD player)              | 9 SYS. CALL (system call) |
| 5 VCR (video cassette recorder) | 10 SETUP                  |

### NOTES:

- "SYS. CALL" 9 and "SETUP" 10 are icons for conducting various settings.
- The buttons in the page display section (B) cannot be operated while the icon display section (A) is displayed.
- The "SETUP" icon cannot be selected by tilting the JOG stick forward or backward.
- If the "SETUP" icon is not displayed in the icon display section, use the ▲ and ▼ buttons to display it.

## Operating preset devices

For details, refer to the individual devices' operating instructions.

To register devices not displayed by default or to change to brands other than those set by default, add the device using the procedure described in section "Preset Memory" on page 10.

For instructions on editing (sorting or deleting) the icon display section, also refer to "Adding new devices" on page 13. Depending on the product, response may be slow. If this is the case, buttons may operate if they are pressed for a little longer than usual.

Note that some devices and some buttons may not be operable.

- 1 Press an icon in the icon display section to select the device to be operated.
- 2 Either press the ◀ and ▶ buttons on the page display section or tilt the JOG stick to the left or right to display the page containing the button you want to operate.
- 3 Press the button you want to operate to send its remote control signal.
  - The displayed button names are the same as the default button names.
  - The button names for buttons from which signals can be transmitted are displayed in black characters.
  - The button names for buttons at which no transmission codes are set are displayed in gray characters.
  - No transmission codes are set for buttons which do not have button names.

## ■ DENON AVAMP (AV amplifier) system buttons

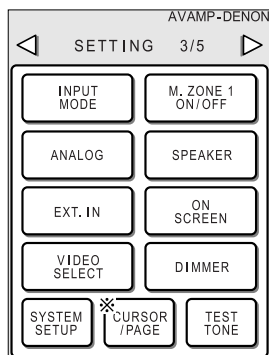
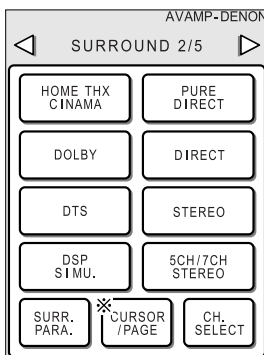
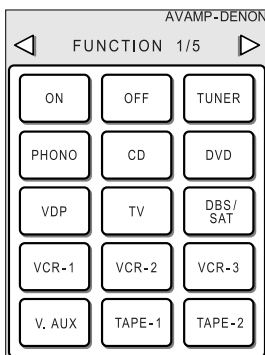

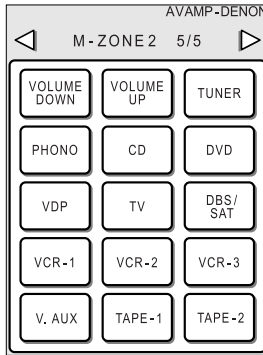
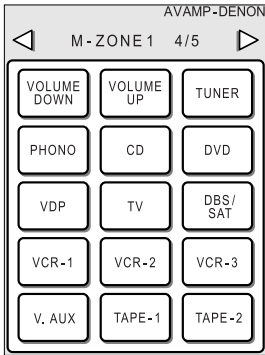

Transmission codes of independent buttons

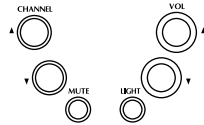

- CH▲ : Tuner preset
- CH▼ : Tuner preset
- VOL▲ : Main volume of AV amplifier
- VOL▼ : Main volume of AV amplifier
- MUTE : Muting of AV amplifier

• Denon AV receivers with one set of multi-room outputs can be operated with the M-ZONE 2 buttons.

※ **About the CURSOR/PAGE button**

When the CURSOR/PAGE button is pressed once, the display is highlighted. When the JOG stick is operated while the display is highlighted, the cursor movement and enter remote control codes are sent. When the CURSOR/PAGE button is pressed again, the display returns to normal and the mode switches back to the normal page operation mode. The CURSOR/PAGE button can be operated when an AV amplifier, DVD player or DBS receiver is selected.

■ **DENON TUNER system buttons**

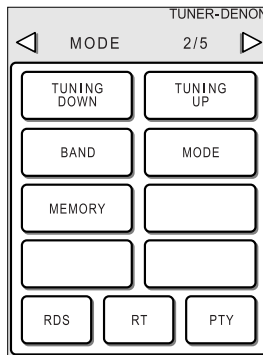
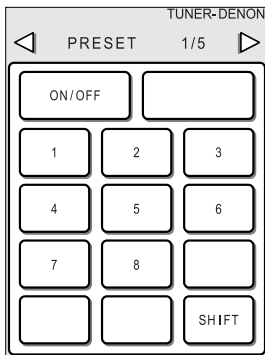

The transmission codes of independent buttons are the same as for "AV AMP".

■ **TV system buttons**

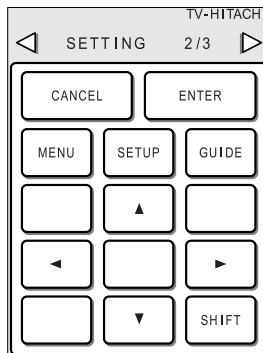
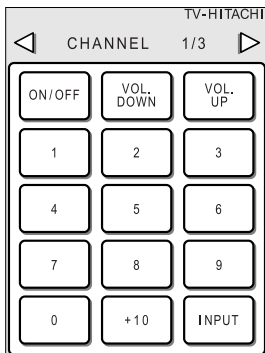

Transmission codes of independent buttons

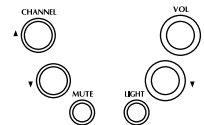

- CH▲ : TV channel
- CH▼ : TV channel
- VOL▲ : Main volume of AV amplifier
- VOL▼ : Main volume of AV amplifier
- MUTE : Muting of AV amplifier

The default setting is HITACHI 1. To change the specified brand, refer to "Changing the preset memory of preset devices" on page 12.

■ DENON DVD (DVD player and DVD changer) system buttons

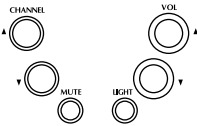
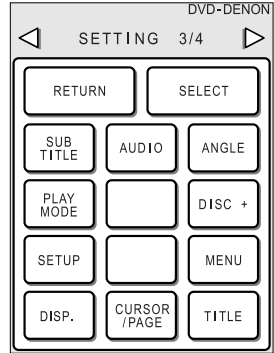
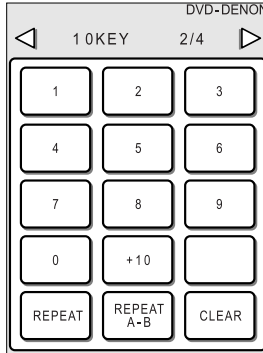
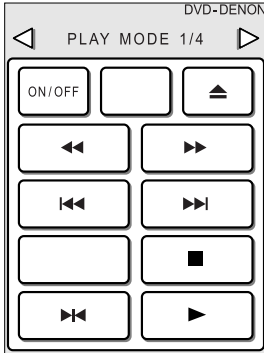

Transmission codes of independent buttons

- VOL▲ : Main volume of AV amplifier
- VOL▼ : Main volume of AV amplifier
- MUTE : Muting of AV amplifier

■ VCR (video cassette recorder) system buttons

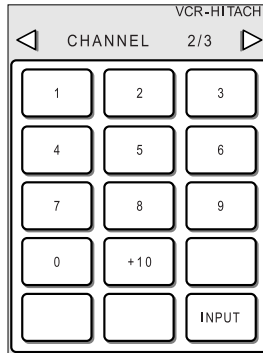
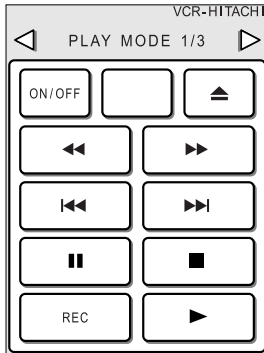

Transmission codes of independent buttons

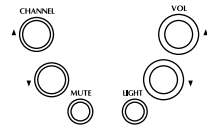

- CH▲ : VCR channel
- CH▼ : VCR channel
- VOL▲ : Main volume of AV amplifier
- VOL▼ : Main volume of AV amplifier
- MUTE : Muting of AV amplifier

The default setting is HITACHI 1. To change the specified brand, refer to "Changing the preset memory of preset devices" on page 12.



■ DENON CD (CD player and CD changer) system buttons

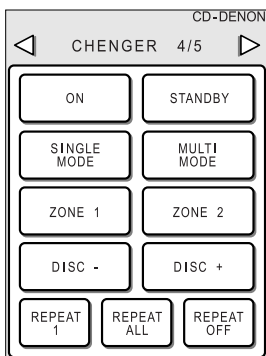
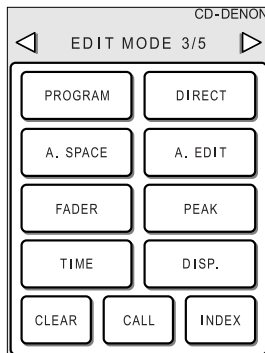
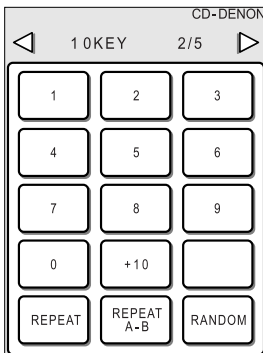
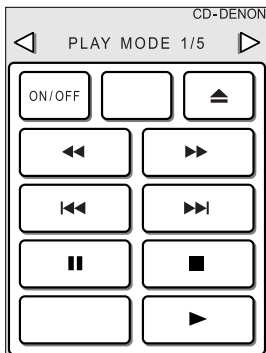

Transmission codes of independent buttons

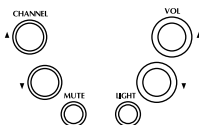

VOL▲ : Main volume of AV amplifier  
 VOL▼ : Main volume of AV amplifier  
 MUTE : Muting of AV amplifier

■ DENON CDR (CD recorder) system buttons

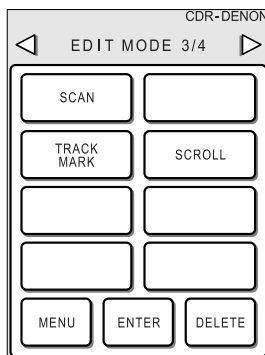
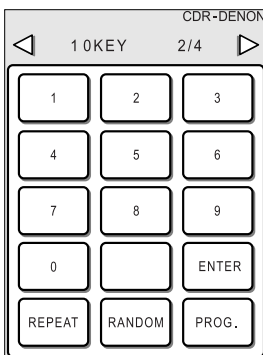
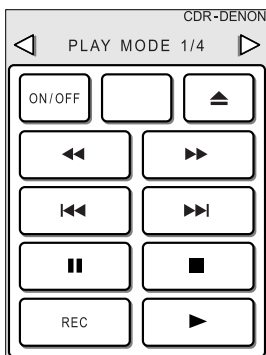

The transmission codes of independent buttons are the same as for "CD".

## ■ TAPE (tape deck) system buttons

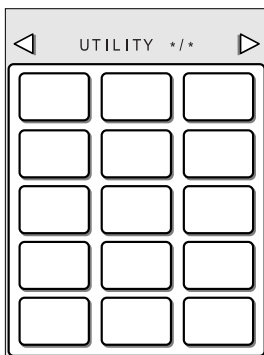
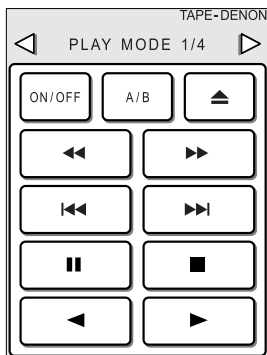

The last page of the page display section for the various devices is a "UTILITY" page. Function buttons you want to register specially can be added to this UTILITY page.

For instructions, refer to "Learning Function" on page 18.

- There is no "UTILITY" page for "AV AMP".

The transmission codes of independent buttons are the same as for "CD".

■ **SYSTEM CALL button** : Refer to "System Call Function (page 20).

■ **SETUP button** : Refer to "Preset Memory" (see below) and "Making the Various Settings" (page 23).

- \* If your device is not one of the devices set in the default settings, make the necessary changes in the preset memory before using that device.
- \* Some devices have multiple Denon codes (DENON 2, etc.). If the device does not operate with the DENON 1 codes, try changing the codes to DENON 2 or DENON 3 using the preset memory.
- \* The names of buttons on the devices you are operating with the RC-8000 may differ from the names of the buttons on the RC-8000. If so, the names can be changed for greater ease using the procedure described in section "Customizing the Buttons" (see page 29).

## Preset Memory

Various remote control codes are preset in the RC-8000.

If your device is one that is preset in the RC-8000, it can be operated from the RC-8000 using the preset memory.

Note that some devices and some buttons may not be operable. If this is not the case, use the learning function (see page 18) to store the device's remote control signals in the RC-8000.

Depending on the product, response may be slow. If this is the case, buttons may operate if they are pressed for a little longer than usual.

### NOTE

There are no preset memory (other manufacturer) settings for the devices listed below.

For these, use the learning function to store the remote control codes of your components in the RC-8000.

① to ⑥ are supplied with Denon codes. By default, no remote control codes are set for ⑦ to ⑩.

- |                         |                         |         |
|-------------------------|-------------------------|---------|
| ① AV AMP (AV amplifier) | ⑤ MD (MD player)        | ⑨ HOME  |
| ② TUNER (AM/FM)         | ⑥ DAT (DAT recorder)    | ⑩ OTHER |
| ③ RCVR (receiver)       | ⑦ PROJ. (projector)     | ⑪ USER  |
| ④ TAPE (tape deck)      | ⑧ AIR (air-conditioner) |         |



















The devices and brands preset in the RC-8000 are listed on the next page (page 11).

These device types feature preset memory settings (other manufacturers codes):

- |                                 |                                      |                           |
|---------------------------------|--------------------------------------|---------------------------|
| ① TV                            | ⑤ CDR (CD recorder)                  | ⑨ LIGHT (lighting device) |
| ② DVD (DVD player)              | ⑥ VDP (video disc player/LD player)  |                           |
| ③ VCR (video cassette recorder) | ⑦ DBS (satellite broadcast receiver) |                           |
| ④ CD (CD player)                | ⑧ CABLE (cable TV)                   |                           |

DVD, CD, CDR and VDP are provided with Denon codes in addition to other manufacturers codes.

The devices and brands indicated in half-tone dot mesh on the table are preset in the RC-8000.

Device icon	Equipment	Manufacturer (codes)	Device icon	Equipment	Manufacturer (codes)
	AVAMP	DENON (1)		CD	DENON (1)
	TUNER	DENON (1)			JVC (1 to 4)
	TV	HITACHI (1 to 4)			KENWOOD (1 to 5)
		JVC (1 to 5)			MARANTZ (1)
		MAGNAVOX (1 to 4)	ONKYO (1, 2)		
		MITSUBISHI (1 to 6)	PANASONIC (1, 2)		
		PANASONIC (1 to 5)	PIONEER (1, 2)		
		PHILIPS (1 to 4)	SONY (1)		
GE (1, 2)	TECHNICS (1 to 4)				
PIONEER (1 to 4)	YAMAHA (1, 2)				
PROSCAN (1)					
RCA (1 to 7)					
SANYO (1, 2)					
SHARP (1 to 4)					
SONY (1)					
TOSHIBA (1 to 4)					
	DVD	DENON (1, 2)		CDR	DENON (1)
		PANASONIC (1)			DENON (2)
		PIONEER (1 to 3)		TAPE	PHILIPS (1)
		RCA (1)			PIONEER (1)
		SONY (1)			
		TOSHIBA (1 to 4)		SETUP	DENON (1)
				SYSTEM CALL	
				VDP	DENON (1 to 3)
					PIONEER (1 to 3)
					SONY (1)
	VCR	HITACHI (1 to 6)		DBS	HITACHI (1)
		GE (1 to 3)			ECHOSTAR (1)
		JVC (1 to 6)		CABLE	GENERAL INSTRUMENT (1)
		MAGNAVOX (1 to 3)			JVC (1)
		MITSUBISHI (1 to 6)			MAGNAVOX (1)
		PANASONIC (1 to 5)			PANASONIC (1)
		PHILIPS (1 to 7)			PRIMESTAR (1)
		PIONEER (1)			RADIO SHACK (1)
		RCA (1 to 8)			RCA (1)
		SANYO (1 to 4)			SONY (1)
		SHARP (1 to 3)			TOSHIBA (1)
		SONY (1 to 3)			UNIDEN (1)
		SYLVANIA (1)			ZENITH (1)
		TOSHIBA (1 to 3)			
	MD	DENON (1)			
					GENERAL INSTRUMENT (1)
					MAGNAVOX (1)
					PANASONIC (1 to 3)
					PIONEER (1, 2)
					RADIO SHAK (1)
					ZENITH (1, 2)
	DAT	DENON (1)			
	RCVR	DENON (1)		PROJ.	
	AIR			LIGHT	LUTRON (1)
	OTHER			HOME	
					USER

**[1] Changing the preset memory of preset devices**

- 1 Touch the liquid crystal display to turn the display on.
- 2 Press the JOG stick to display the icon display section.
- 3 Press the ▲ and ▼ buttons in the icon display section to display the "SETUP" icon.
  - a. Display the "SETUP" icon in the icon display section, then press this "SETUP" icon for at least 3 seconds to display the setup screen (a).
  - Press the "Edit Device" button on the "Setup 1/4" page to display the device selection screen (b).
  - b. Press the icon in the icon display section for the device whose preset memory you want to change to display the brand selection screen (c).
  - c. Use the ▲ and ▼ buttons on the brand list to display the desired brand, then press the "Brand name" button to display the code selection screen (d).
  - d. Select and press the code number from the code list. The transmission test screen (e) appears.
  - e. Press the "ON/OFF" button on the transmission test screen to check the operation of the device. (If the code is right, the power of the device you are attempting to operate should turn on and off.)  
If the device has operated, press the "OK" button to select that preset memory.  
If the device has not operated, press the "Cancel" button and try a different code.  
If the desired preset code is not listed, press the "CANCEL" button on the code selection screen (d) then select "NONE" at the very bottom of the brand selection screen (c).  
In this case the preset memory is not set.
  - f. Once "Setup Successful" (f) appears, the preset memory is set and the device selection screen reappears.

When the "Cancel" button is pressed at the device selection screen, the setup screen reappears. Press any icon other than "SETUP" on the setup screen to cancel the setup mode and return to the transmission screen.

Screen (a)

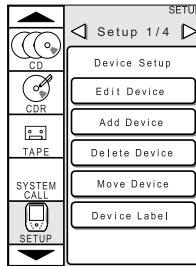

Screen (b)

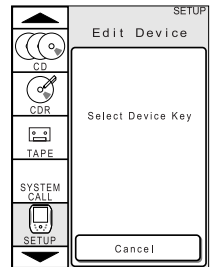

Screen (c)

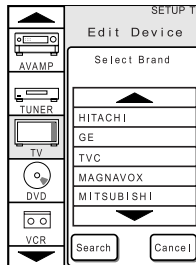

Screen (d)

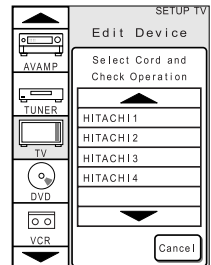

Screen (e)

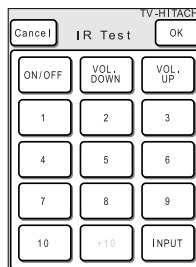

Screen (f)

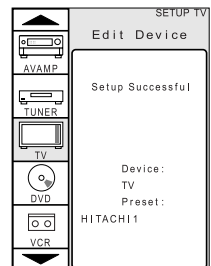

**[2] Adding new devices**

- Press the "SETUP" icon in the icon display section for at least 3 seconds to display the setup screen (a). Press the "Add Device" button on the "Setup 1/4" page to display the device selection screen (b).
  - \* Twenty device names are displayed in alphabetical order.
- Use the ▲ and ▼ buttons on the device list to display the desired device type, then press the "Type" button to display the brand selection screen (c).
- After displaying the desired brand name, press the "Brand name" button to display the code selection screen (d).
- Select and press the code number from the code list. The transmission test screen (e) appears.
- Press the "ON/OFF" button on the transmission test screen to check the operation of the device. (If the code is right, the power of the device you are attempting to operate should turn on and off.) If the device has operated, press the "OK" button to select that preset memory. If the device has not operated, press the "Cancel" button and try a different code. If the desired preset code is not listed, press the "CANCEL" button on the code selection screen (d) then select "NONE" at the very bottom of the brand selection screen (c). In this case the preset memory is not set.
- Once "Setup Successful" (f) appears, the preset memory is set and the device selection screen reappears.

When the "Cancel" button is pressed at the device selection screen, the setup screen reappears. Press any icon other than "SETUP" on the setup screen to cancel the setup mode and return to the transmission screen.

Screen (a)

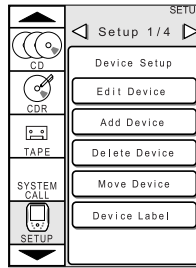

Screen (b)

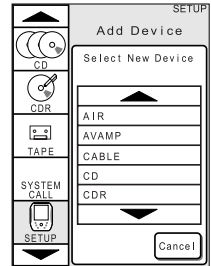

Screen (c)

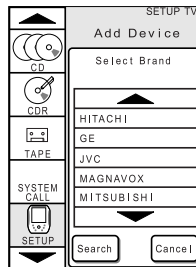

Screen (d)

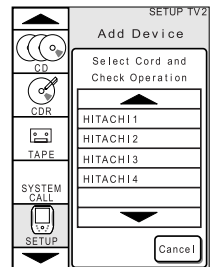

Screen (e)

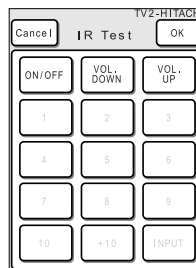

Screen (f)

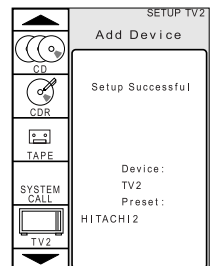

**[3] Operating devices for which the preset memory is set**

For details, refer to the individual devices' operating instructions.

※ Note that some devices and some buttons may not be operable.

If this case, use the learning function to store the device's remote control signals in the RC-8000.

- ① Press an icon in the icon display section to select the device to be operated.
- ② Use the ◀ and ▶ buttons in the page display section to display the page on which the button you want to operate is located.
- ③ Press the button you want to operate to send its remote control signal.

- The displayed button names are the same as the default button names.
- The button names for buttons from which signals can be transmitted are displayed in black characters.
- The button names for buttons at which no transmission codes are set are displayed in gray characters.
- No transmission codes are set for buttons which do not have button names.

**NOTES:**

- The signals registered at the buttons (the presence or absence of transmission codes) depend on the preset code which has been set.
- If the contrast is strong, it may be difficult to read gray characters. If this is the case, adjust the contrast so that gray characters are easier to read.

※ The names of buttons on the devices you are operating with the RC-8000 may differ from the names of the buttons on the RC-8000. If so, the names can be changed for greater ease using the procedure described in section "Changing the button names" (page 30).

■ **TV preset memory buttons**

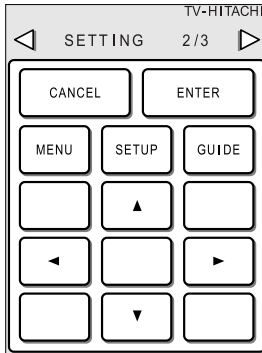
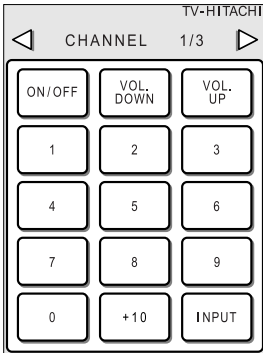

Transmission codes of independent buttons

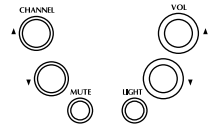

- CH▲ : TV channel
- CH▼ : TV channel
- VOL▲ : Main volume of AV amplifier
- VOL▼ : Main volume of AV amplifier
- MUTE : Muting of AV amplifier

■ **DVD (DVD player and DVD changer) preset memory buttons**

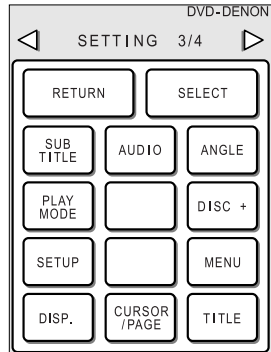
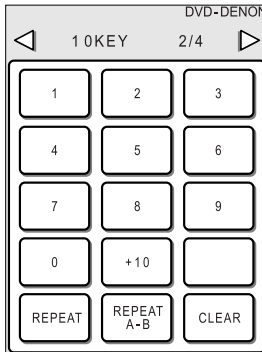
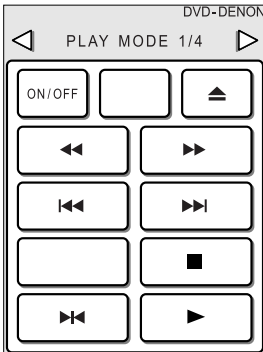

■ VCR (video cassette recorder) preset memory buttons

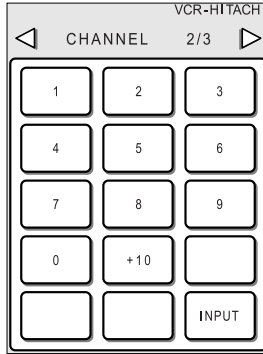
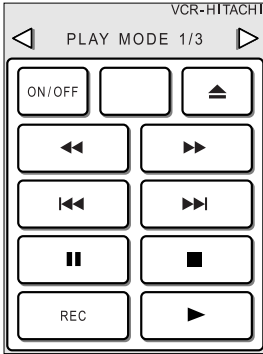

Transmission codes of independent buttons

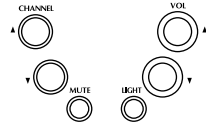

- CH▲ : VCR channel
- CH▼ : VCR channel
- VOL▲ : Main volume of AV amplifier
- VOL▼ : Main volume of AV amplifier
- MUTE : Muting of AV amplifier

■ CD (CD player and CD changer) preset memory buttons

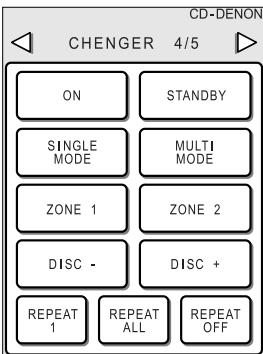
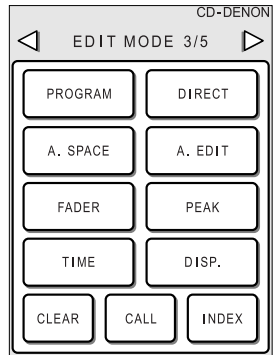
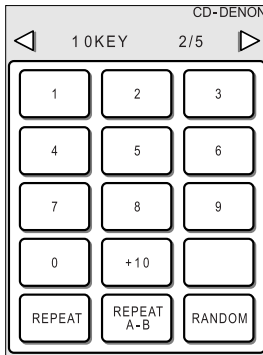
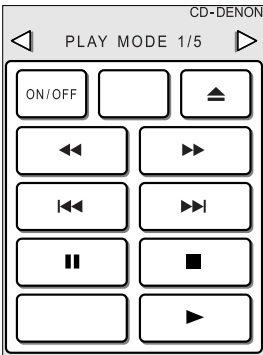

Transmission codes of independent buttons

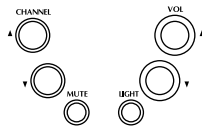

- VOL▲ : Main volume of AV amplifier
- VOL▼ : Main volume of AV amplifier
- MUTE : Muting of AV amplifier

## ■ CDR (CD recorder) preset memory buttons

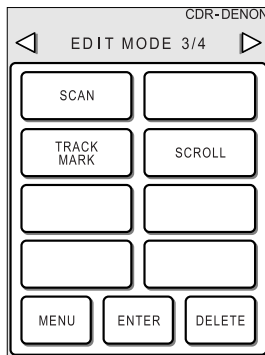
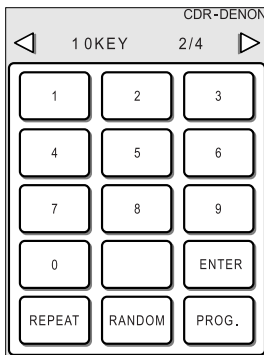
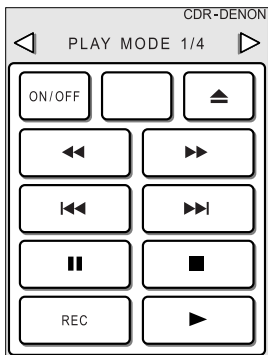

## ■ VDP (video disc player) preset memory buttons

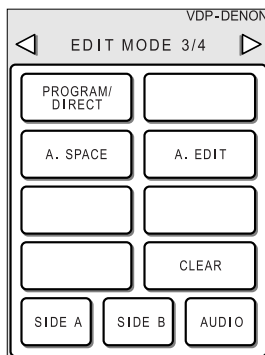
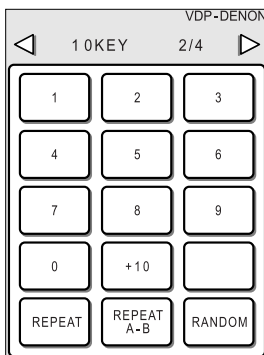
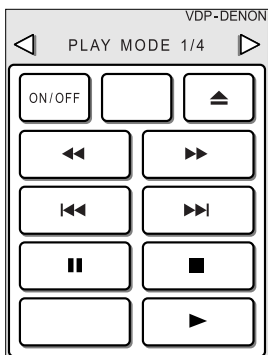

## ■ DBS (satellite) preset memory buttons

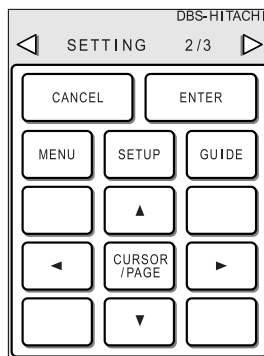
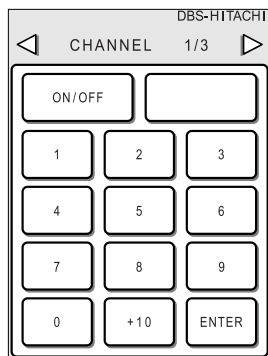

Transmission codes of independent buttons

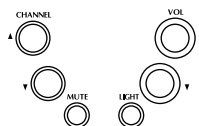

- CH▲ : DBS channel
- CH▼ : DBS channel
- VOL▲ : Main volume of AV amplifier
- VOL▼ : Main volume of AV amplifier
- MUTE : Muting of AV amplifier



■ Cable (cable TV) preset memory buttons

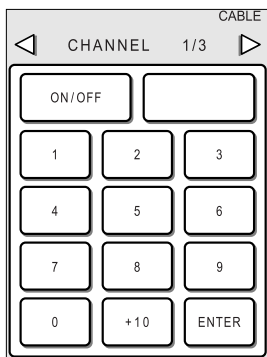

Transmission codes of independent buttons

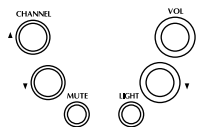

- CH▲ : Cable channel
- CH▼ : Cable channel
- VOL▲ : Main volume of AV amplifier
- VOL▼ : Main volume of AV amplifier
- MUTE : Muting of AV amplifier

■ LIGHT preset memory buttons

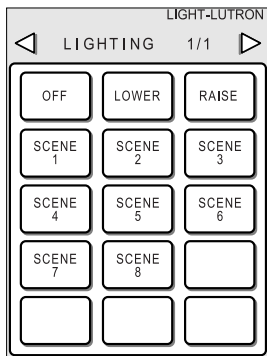

The transmission codes of independent buttons are the same as for "CD".

※ A "UTILITY" page is added at the last page for the device. Buttons can be added to this page using the learning function. Refer to the instructions on using the learning function in section to "learn" buttons. (Refer to page 18 for details.)

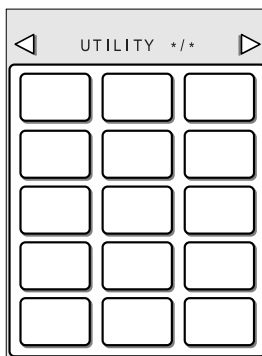

## Learning Function

Devices and buttons that cannot be operated using the preset memory (for which no preset signals are stored) can be operated by storing the remote control signals of that device in the RC-8000.

- Remote control signals can be “learned” at the buttons on the liquid crystal display.
- Remote control signals can also be “learned” at the independent CH. UP and DOWN, VOL. UP and DOWN and MUTE buttons.

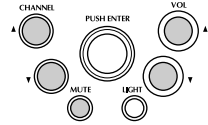

Independent buttons

### [1] Using the learning function

- 1 Press the “SETUP” icon in the icon display section for at least 3 seconds to display the setup screen. Press the “Key Learning” button on the “Setup 2/4” page to display the device selection screen.
- 2 Press the icon in the icon display section for the device whose button(s) you want to learn to display the button selection screen.
- 3 Use the ◀ and ▶ buttons in the page display section to display the page on which the button you want to learn is displayed. Point the source remote control towards the RC-8000. Press the button you want to learn on the RC-8000. The button is highlighted. Then, press the button you want to learn on the source remote control unit while the button on the RC-8000 is highlighted.

※ The display is highlighted for approximately 30 seconds.

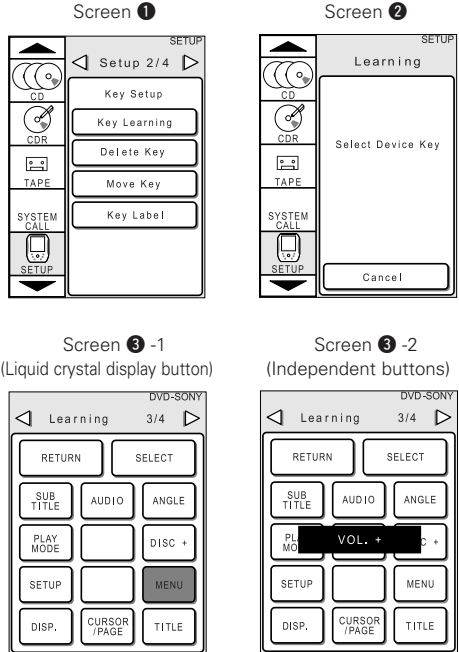

Other remote control unit

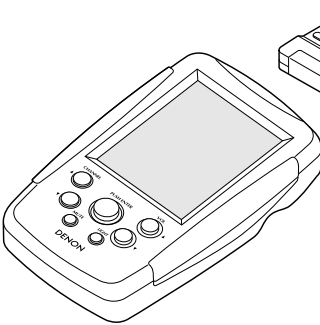

5 ~ 10 cm  
2 ~ 4 inches

- 4 When learning is successful, "SUCCESS" is displayed. After this, the button name input screen ("Key Label") appears. Button name entry will not be possible when an independent button has been used for learning.
- 5 For buttons that have default button names, the button name is displayed with a half-tone dot mesh. Press the "OK" button to set that button name and return to the device selection screen. (For buttons that do not have default button names, "NEW" is displayed. Select the desired button name from the list of button names.)

Screen 4

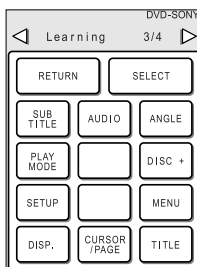

Screen 5

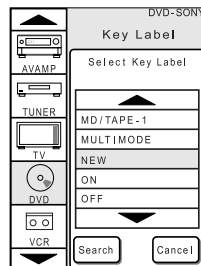

**NOTE:**

To use labels edited using manual input before learning, press the "Cancel" button at the screen on which "NEW" is displayed 5 to cancel.

When the "Cancel" button is pressed at the device selection screen, the setup screen reappears. Press any icon other than "SETUP" on the setup screen to cancel the setup mode and return to the transmission screen.

**[2] Inputting button names**

- 1 Inputting button names using the preset names ("labels")
  - a. To change the button name, use the ▲ and ▼ buttons on the list of labels at the label selection screen ("Key Label") to display the button name you wish to input from among the preset button names (preset labels).
  - b. Press the button name you wish to input. That button is displayed with a half-tone dot mesh. Now press the "OK" button to set that button name.
- 2 Inputting characters manually
  - a. To input a button name other than the preset labels, use the ▲ and ▼ buttons on the label selection screen to display "NEW" (located among the preset labels).
  - b. Press "NEW". The "NEW" button is displayed with a half-tone dot mesh. Now press the "NEW" button again. A cursor appears under the "N" and the manual input mode is set.
  - c. Use the JOG switch's left and right buttons to move the position of the cursor in the button name.
  - d. Use the JOG switch's up and down buttons to change the character at the position of the cursor.
  - e. Once the name is input, press the button name's half-tone dot mesh display again. The cursor turns off and the manual input mode is cancelled.
  - f. Press the "OK" button to set that button name.

List of manual input characters

Character	Character	Character	Character	Character	Character	Character	Character
(space)	,	8	D	P	\	h	t
!	-	9	E	Q	]	i	u
"	.	:	F	R	^	j	v
#	/	;	G	S	_	k	w
\$	0	<	H	T	'	l	x
%	1	=	I	U	a	m	y
&	2	>	J	V	b	n	z
'	3	?	K	W	c	o	{
(	4	@	L	X	d	p	
)	5	A	M	Y	e	q	}
*	6	B	N	Z	f	r	~
+	7	C	O	[	g	s	

**System Call Function**

The RC-8000 is equipped with a system call function for emitting a series of remote control signals by pressing a single button.

This function can be used for example to turn on the power of the amplifier, switch the amplifier's input source, turn on the power of a monitor TV, turn on the power of a DVD player, and set the DVD player to the play mode – all at the touch of a single button.

**[1] System call buttons**

There are 20 system call buttons.

Remote control signals for a maximum of 10 operations can be stored at each button.

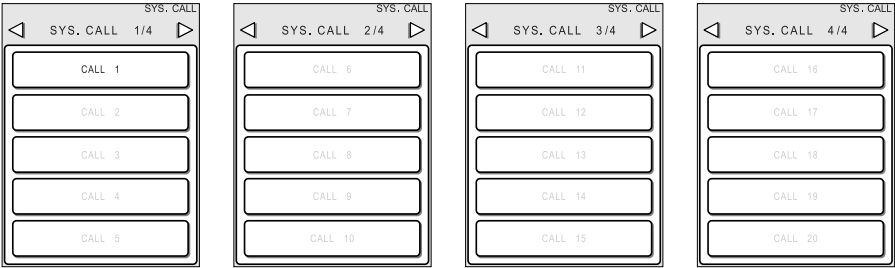

**[2] Storing system call signals**

The following explanation uses the procedure of actually registering the following system call signals as an example.

- Settings: Turn on AV amplifier power
- Switch AV amplifier input to DVD
- Turn on DVD player power
- Set DVD player to play mode

1 Press "SETUP" on the icon display section for 3 seconds to display the setup screen. Press the "Sys. Call Setup" button on the "Setup 3/4" page to display the system call selection screen.

2 Press the "Add" button on the system call selection screen to set the mode for inputting buttons to be registered in the system call setting.

3 Select the buttons whose signals you want to store at a system call button.

The device registered at the top of the icon display section is displayed first. (By default, AV amplifier page 1 is displayed.) Here, press the AV amplifier "ON" button and the "DVD" button.

※ To select other devices, press the JOG switch's ENTER button to display the icon display section, then select the device.

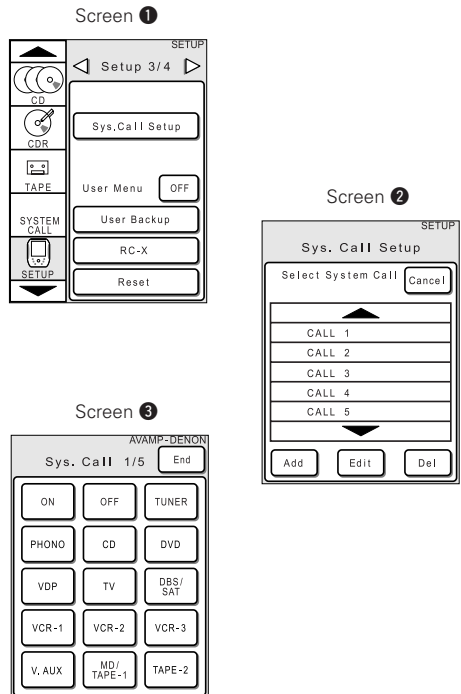



- ③-2 Deleting buttons
  - a. At the system call editing screen, press the button you want to delete so that it is displayed in half-tone dot mesh.
  - b. Press the "Del" button. The setting is deleted.
- ③-3 Changing the order of buttons
  - a. At the system call editing screen, press the button you want to move so that it is displayed in half-tone dot mesh.
  - b. Press the "Move" button, then press the button at the position to which you want to move the first button. The first button is inserted at the position before the second button.
- ③-4 Adding buttons
  - a. Press the "Add" button at the system call editing screen to set the mode for registering buttons to be added.
    - \* Refer to "Storing system call signals" (page 20).
  - b. Buttons registered at this time are added after already registered buttons.

**[4] Deleting registered system call settings**

- ① Press "SETUP" on the icon display section for 3 seconds to display the setup screen. Press the "Sys. Call Setup" button on the "Setup 3/4" page to display the system call selection screen.
- ② Press the ▲ and ▼ buttons on the call list to display the system call button whose settings you want to delete. Press the system call button whose settings you want to delete so that it is displayed in half-tone dot mesh, then press the "Del" button. The system call setting is deleted.

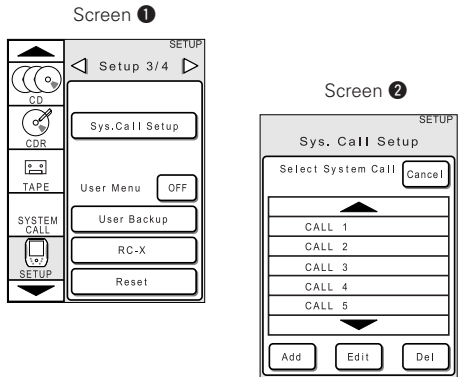

**[5] Sending system call signals**

Press the "Sys. Call" icon in the icon display section to display the system call sending screen. Use the ◀ and ▶ buttons in the page display section to display the page containing the system call button whose signals you want to send. Press the system call button. System call buttons at which remote control signals are stored are displayed in black. Those at which no remote control signals are stored are displayed in gray.

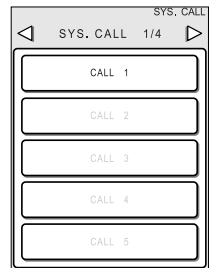

**[6] Changing the system call button names**

- ① Press the "SETUP" icon in the icon display section for at least 3 seconds to display the setup screen. Press the "Sys. Call Setup" button on the "Setup 3/4" page to display the system call selection screen.
- ② Press the system call button whose name you want to change. The button switches to a half-tone dot mesh. Press the same button again. A cursor appears under the "C" in the button's name, indicating that the input mode is set.
- ③ Input the name using the procedure described in section "Inputting button names" (page 19).
- ④ Once the name is input, press the system call button again. The cursor turns off and the system call button name is changed.

Up to 15 characters can be input for system call button names.

**Making the Various Settings**

**[1] Backing up the current settings**

With the RC-8000, the current settings can be backed up.

When you back up the settings, the settings are not lost even when the RESET button (page 4) is pressed or the batteries are replaced.

Press the "SETUP" icon in the icon display section for at least 3 seconds to display the setup screen.

Press the "User Backup" button on the "Setup 3/4" page to display the confirmation screen, then press the "Yes" button. The current settings of the RC-8000 are backed up.

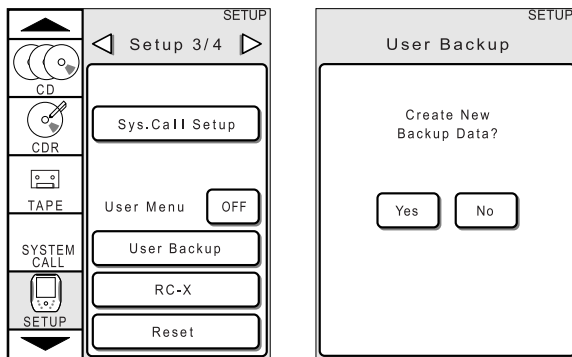

**[2] Making the sound settings**

Here, set the sound that is made when buttons are pressed. (By default, this is set to "ON".)

When this is set to "ON", a sound is produced each time a button is operated. When set to "OFF", no sound is produced when buttons are pressed.

Press the "SETUP" icon in the icon display section for at least 3 seconds to display the setup screen.

Press the "Sound ON" button on the "Setup 4/4" page to switch the setting to "OFF".

The display changes each time the button is pressed. The displayed setting is the current setting.

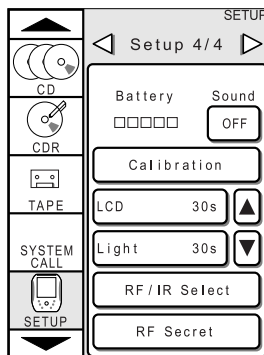

**[3] Setting the liquid crystal display's auto off time**

With the RC-8000, the liquid crystal display automatically turns off if no buttons are pressed within a specific amount of time.

To make the batteries last longer, we recommend that you do not set this time any longer than necessary.

Press the "SETUP" icon in the icon display section for at least 3 seconds to display the setup screen.

Press the "LCD 10s" button on the "Setup 4/4" page. The button switches to a half-tone dot mesh.

Now use the ▲ and ▼ buttons to set the auto off time. The time can be set between 1 and 60 seconds in steps of 1 second.

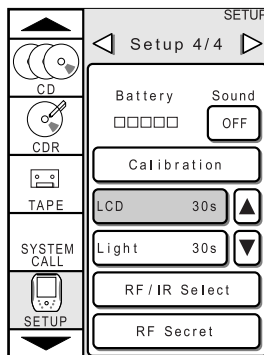

**[4] Setting the back light's auto off time**

With the RC-8000, the back light automatically turns off if no buttons are pressed within a specific amount of time.

To make the batteries last longer, we recommend that you do not set this time any longer than necessary.

Press the "SETUP" icon in the icon display section for at least 3 seconds to display the setup screen. Press the "Light 5s" button on the "Setup 4/4" page. The button switches to a half-tone dot mesh. Now use the ▲ and ▼ buttons to set the auto off time. The time can be set between 0 and 300 seconds in steps of 1 second. When set to "0", the back light remains lit, even when the LIGHT button is pressed.

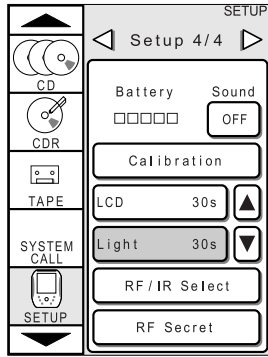

- ※ It is not possible to set the back light auto off time to a time longer than the liquid crystal display's auto off time.
- ※ When performing the system setup procedure for Denon AV receivers, set the LCD's auto off time to a long time before operating.

**Resetting**

The reset function resets all the settings to the factory defaults.

- a. Press "SETUP" in the icon display section for at least 3 seconds to display the setup screen. Press the "Reset" button on the "Setup 3/4" page to display the reset confirmation screen.
- b. At the reset confirmation screen, press the "Yes" button. The RC-8000 is reset.

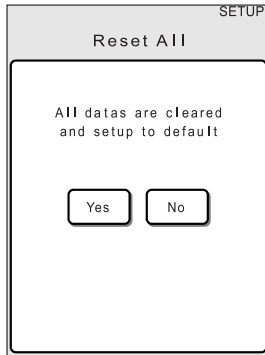
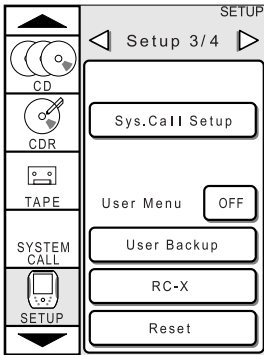

**NOTE:**

Note that when the above operation is performed, the data backed up in section "Backing up the current settings" (page 23) is also deleted and the RC-8000 can no longer be restored to the customized settings.



## 5 OTHER REGISTERABLE DEVICES

The devices shown below can also be registered.

There is no preset memory for these additional devices. Use the learning function to store their signals.

**NOTE:**

For "AIR" (air-conditioner), some air-conditioner remote control signals include time and temperature data sent along with the control codes, so they may not work properly when they are "learned" in the RC-8000.

■ PROJECTOR 

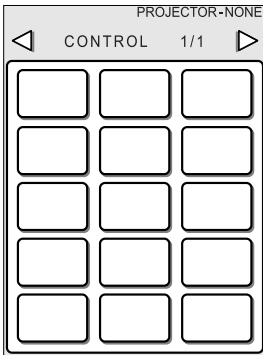

■ HOME 

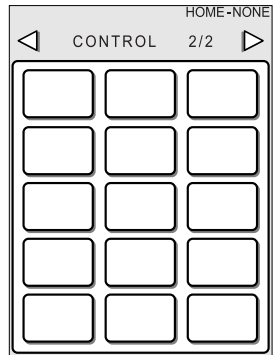
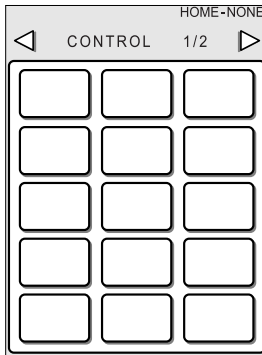

■ AIR 

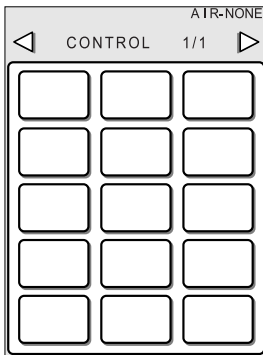

■ OTHER

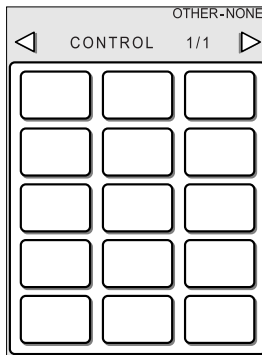

## 6 Customizing (setting the operating environment)

### Editing the Icon Display Section

With the RC-8000, a total of up to 23 devices to be operated can be registered.

Up to 8 devices of the same type can be registered.

Icons for the registered devices are displayed in the icon display section. If more than one device of the same type is registered, the devices are identified by numbers. (For example: CD2)

The types (categories) of registrable devices and their icons are shown below.

There are no icons for "USER" or "OTHER".

Registrable devices and their icons

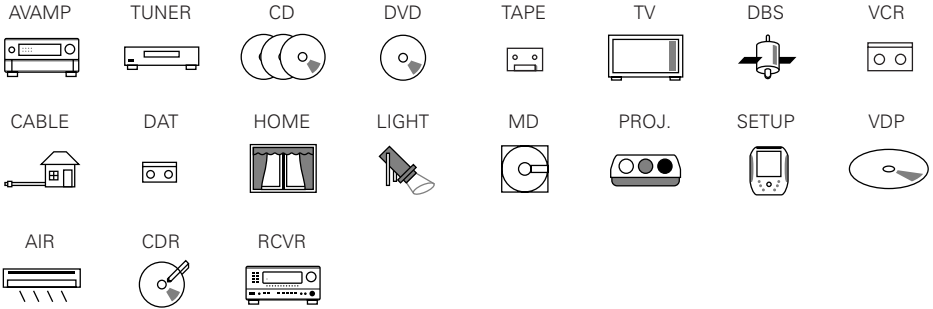

#### [1] Adding devices

For instructions on adding new devices, refer to section "Adding new devices" on page 13.

For types of devices for which there is no preset memory, the preset memory selection screen is not displayed, but the device can be added.

#### [2] Deleting devices

Use the procedure described below to delete devices that have been added.

- Press "SETUP" in the icon display section for at least 3 seconds to display the setup screen. Press the "Delete Device" button on the "Setup 1/4" page to display the device selection screen.
- Use the ▲ and ▼ buttons in the icon display section to display the icon for the device you want to delete, then press that icon to display the delete confirmation screen.
- Press the "Yes" button to delete that device. The icon for the deleted device disappears from the icon display section.

※ "SYSTEM CALL" and "SETUP" cannot be deleted.

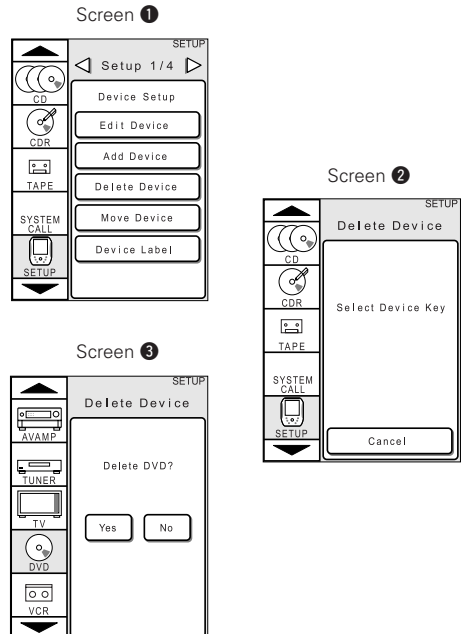

**[3] Changing the positions of devices in the icon display section**

Use the procedure described below to change the order of the devices displayed in the icon display section.

- 1 Press "SETUP" in the icon display section for at least 3 seconds to display the setup screen. Press the "Move Device" button on the "Setup 1/4" page to display the device selection screen.
- 2 Use the ▲ and ▼ buttons in the icon display section to display the icon for the device you want to move, then press that icon.
- 3 Press the icon at the position to which you want to move the first icon. A confirmation screen appears. Press the "Yes" button. The first icon is inserted at the position before the second icon.

Screen 1

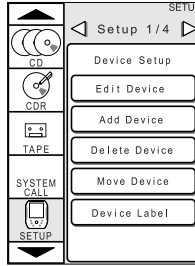

Screen 2

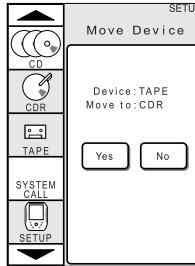

Screen 3

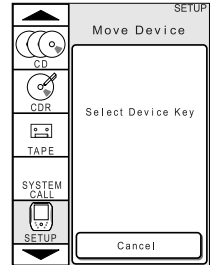

**[4] Registering device names**

Use the procedure described below to register names, etc., for registered devices.

- 1 Press "SETUP" in the icon display section for at least 3 seconds to display the setup screen. Press the "Device Label" button on the "Setup 1/4" page to display the device selection screen.
- 2 Use the ▲ and ▼ buttons in the icon display section to display the icon for the device for which you want to register a device name, etc., then press that icon.
- 3 Input the device name, etc. " \_ " (under bar) is displayed at the left edge. The place where this is displayed can be edited. For instructions on inputting the device name, etc., refer to section "Inputting button names" on page 19. Once the device name, etc., has been input, press the "OK" button to register that device name.

Screen 1

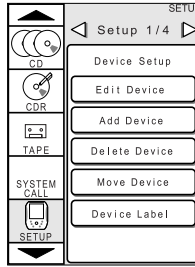

Screen 2

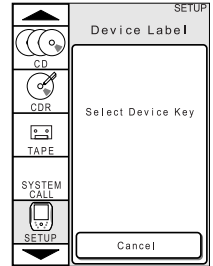

Screen 3

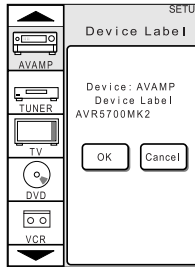

Registered device names are displayed as shown below. Up to 16 characters can be input for device names.

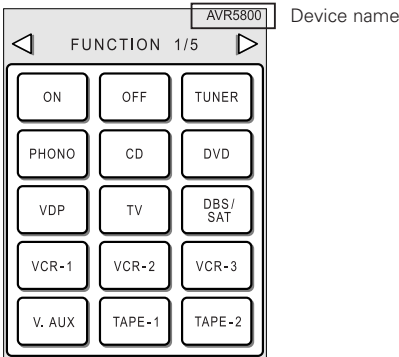

**Customizing the Buttons**

**[1] Adding buttons**

"Learn" buttons to add them.

Refer to section "Using the learning function" on page 18.

**[2] Deleting buttons**

- 1 Press "SETUP" in the icon display section for at least 3 seconds to display the setup screen. Press the "Delete Key" button on the "Setup 2/4" page to display the device selection screen.
- 2 Use the ▲ and ▼ buttons in the icon display section to display the icon for the device with the button you want to delete, then press that icon. The button selection screen appears.
- 3 Use the ◀ and ▶ buttons in the page display section to display the page containing the button you want to delete. A confirmation screen appears.
- 4 Press the "OK" button. The button name is deleted, and the remote control signals are also deleted. (The button itself remains.)

Screen 1

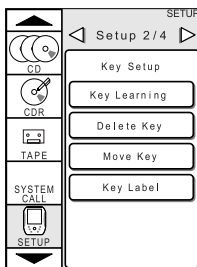

Screen 2

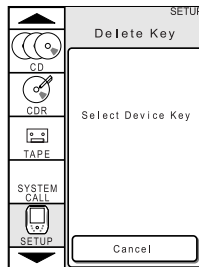

Screen 3

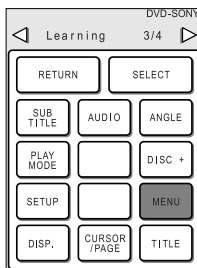

Screen 4

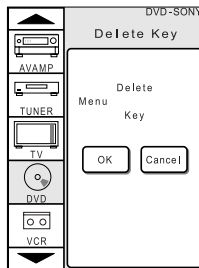

**[3] Moving buttons**

Use the procedure described below to move the positions of buttons with screens for specific devices.

- 1 Press "SETUP" in the icon display section for at least 3 seconds to display the setup screen. Press the "Move Key" button on the "Setup 2/4" page to display the device selection screen.
- 2 Use the ▲ and ▼ buttons in the icon display section to display the icon for the device with the button you want to move, then press that icon. The button selection screen appears.

Screen 1

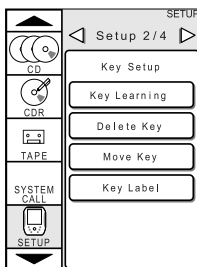

Screen 2

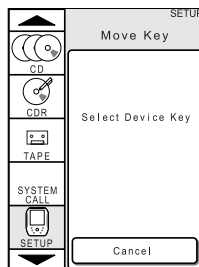

- 3 Use the ◀ and ▶ buttons in the page display section to display the page containing the button you want to move, then press that button.
- 4 Now press the button at the position to which you want to move the first button. The buttons automatically switch places.
  - ※ It is not possible to move small buttons to the positions of large buttons and vice versa.
  - ※ Buttons cannot be moved to pages of other devices.

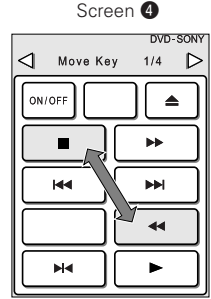
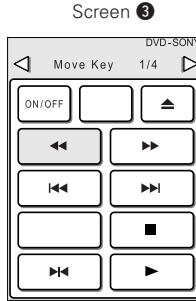

**[4] Changing button names**

- 1 Press "SETUP" in the icon display section for at least 3 seconds to display the setup screen. Press the "Key Label" button on the "Setup 2/4" page to display the device selection screen.
- 2 Use the ▲ and ▼ buttons in the icon display section to display the icon for the device with the button whose name you want to change, then press that icon. The button selection screen appears.
- 3 Use the ◀ and ▶ buttons in the page display section to display the page containing the button whose name you want to change, then press that button. The character input screen appears.
- 4 Input the button name.
  - For instructions on inputting button names, refer to "Inputting button names" (page 19).
  - ※ Up to 2 lines of 6 characters can be input for small buttons, and up to 2 lines of 8 characters can be input for large buttons.

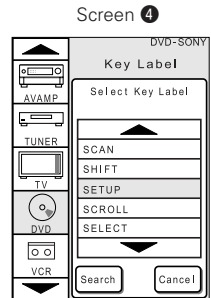
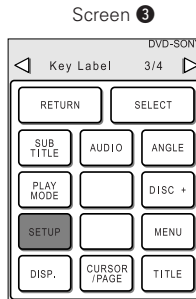
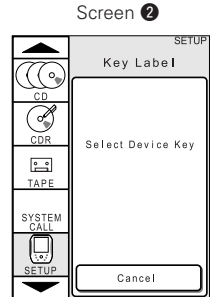
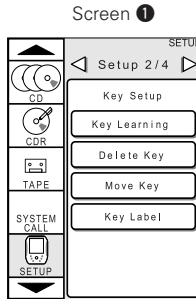

## User Menu

When "USER" is registered in the icon display section and the "User Menu" is set, the user screen ("CUSTOM 1/2") always appears when the liquid crystal display is redisplayed.

"Learn" buttons that are frequently used at the user menu to eliminate the trouble of searching for buttons and make operation easier.

- Press the "SETUP" icon in the icon display section for at least 3 seconds to display the setup screen. Press the "User Menu OFF" button on the "Setup 3/4" page to set this to "ON". When this is done, the user menu is always displayed when the liquid crystal display is redisplayed. The setting switches between "ON" and "OFF" each time the button is pressed.

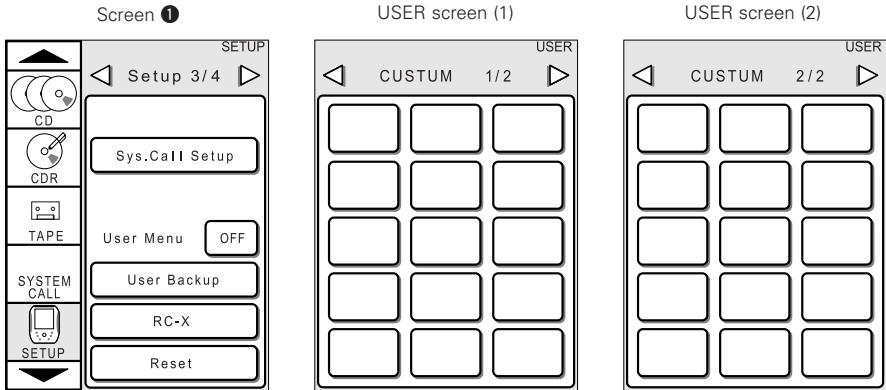

This setting cannot be made unless "USER" is registered in the icon display section.

## 7 ONE-BUTTON SEARCH FUNCTION

Try using this function if you cannot find the desired remote control signals with the normal preset memories.

### [1] Using the one-button search function

Learn the "POWER" button of the remote control unit for which you want to set the preset memory in order to search for the preset memory for those remote control signals.

- At the "Edit Device" and "Add Device" brand selection screens when setting the preset memory in section "Changing the preset memory of preset devices" on page 12, press the "Search" button to display the learning start screen.
- Press the "Learning Start" button on the learning start screen, then press the "POWER" button of the remote control unit for which you want to set the preset memory to learn it.

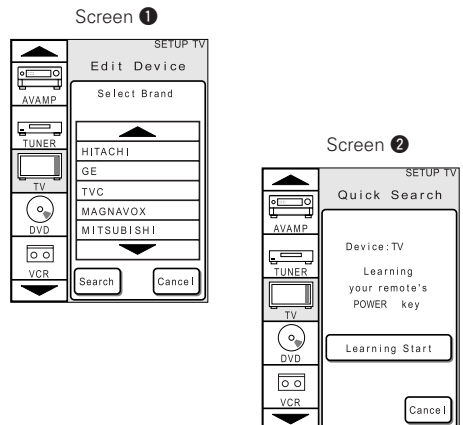

- ③ Once the button is successfully learned, the preset memory search operation starts.  
Once the search operation is successfully completed, a list of the preset memory codes is displayed.  
Select the code and check that the device operates properly.  
Continue the procedure as described in section "Changing the preset memory of preset devices" on page 12.

**NOTES:**

- If the corresponding preset memory is not found with the search operation, "NONE" is set automatically.
- A manufacturer (brand) other than the manufacturer (brand) of your remote control unit may be displayed. If the remote control unit works with the displayed manufacturer's codes, use it as such, without worrying about the name of the manufacturer.

Screen ③

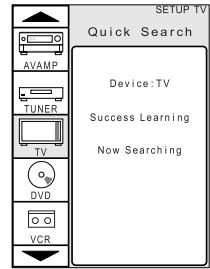

## 8 RF TRANSMISSION FUNCTION

RF transmission is possible when the RC-8000 is used in combination with the separately sold RC-8001ST charger base station.

For instructions, refer to the RC-8001ST's operating instructions.

## 9 FACTORY DEFAULT SETTINGS

Registered device:	AVAMP, TUNER, TV, DVD, VCR, CD, CDR, TAPE, SYS. CALL, SETUP
LCD off (LCD) time:	10 seconds
Back light off (Light) time:	5 seconds
Sound setting (Sound):	ON

## 10 SPECIFICATIONS

Dimensions:	96 mm (width) x 38 mm (height) x 168.5 mm (depth) (3-25/32" x 1-1/2" x 6-41/64")
Mass:	242 g (8.5 oz) (not including batteries)
Battery service life:	Approx. 3 months (under standard usage conditions)
Distance:	Approximately 7 meters (22 feet)
Angle:	Up to 30 degrees
Accessories:	LR6 (AA size) alkaline batteries . . . .4 Operating instructions . . . . .1 Service station list . . . . .1 Warranty * . . . . .1

\* When the RC-8000 is acquired as an accessory included with the AVR-5800, there is no separate warranty for the RC-8000. (The warranty is only for the AVR-5800.)

\* For purposes of improvement, specifications and design are subject to change without notice.



## 11 CAUTIONS ON USE

### ■ Place of use

Do not drop or subject to strong shocks. Doing so could result in damage.

### ■ Handling

The touch panel (display) is made of glass. Do not apply pressure to it, drop the set, lean on the touch panel with your elbows or place heavy objects on it. Doing so could break the touch panel and the fragments of glass could cause injury.

### ■ Cleaning

Use a soft cloth to wipe dirt off the touch panel (display), the surface of the case and the buttons. Do not use thinner, benzene, alcohol, etc., as they could damage the surface.

## 12 TROUBLESHOOTING

If this unit is not operating properly, check the items listed in the table below. Should the problem persist, there may be a malfunction.

Disconnect the power immediately and contact your store of purchase.

Symptom	Cause	Measures
Operation is not possible.	<ul style="list-style-type: none"> <li>The unit is too far from the amplifier.</li> <li>There is an obstacle between the unit and the amplifier.</li> <li>The amplifier's power is not on.</li> <li>The transmitter is not pointed at the amplifier.</li> <li>There is an inverter type fluorescent light near the unit or the amplifier.</li> <li>You are using products of other brands.</li> </ul>	<ul style="list-style-type: none"> <li>Move the unit closer to the amplifier (within 7 meters) when operating it.</li> <li>Remove the obstacle.</li> <li>Turn on the amplifier's power.</li> <li>Point the transmitter at the amplifier.</li> <li>Move the unit and the amplifier away from the fluorescent light.</li> <li>Depending on the manufacturer and type of product, it may not be possible to operate product with this unit.</li> </ul>
Liquid crystal display does not turn on.	<ul style="list-style-type: none"> <li>The panel is turned off.</li> <li>The brightness is not properly set.</li> </ul>	<ul style="list-style-type: none"> <li>Touch the touch panel or press the LIGHT button. If LCD is still not displayed, press the RESET button. (See page 4.)</li> <li>Refer to "Adjusting the brightness of the liquid crystal display" (see page 4) and adjust the brightness of the liquid crystal display.</li> </ul>
Touch panel cannot be operated accurately.	<ul style="list-style-type: none"> <li>Touch panel adjustment is off.</li> </ul>	<ul style="list-style-type: none"> <li>Adjust the touch panel. (See page 5.)</li> </ul>

# DENON

## CHARGER BASE STATION

# RC-8001ST

## OPERATING INSTRUCTIONS MODE D'EMPLOI

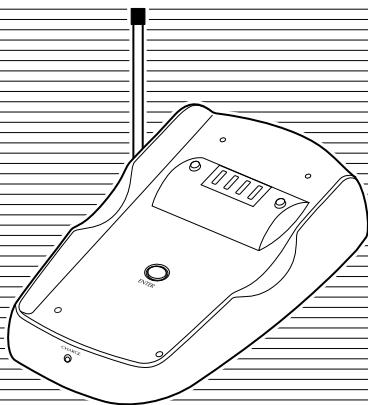

"SERIAL NO. \_\_\_\_\_

PLEASE RECORD UNIT SERIAL NUMBER ATTACHED TO THE REAR OF THE CABINET FOR FUTURE REFERENCE"

"NO. DE SERIE \_\_\_\_\_

PRIERE DE NOTER LE NUMERO DE SERIE DE L'APPAREIL INSCRIT A L'ARRIERE DU COFFRET DE FAÇON A POUVOIR LE CONSULTER EN CAS DE PROBLEME."

- We greatly appreciate your purchase of this unit.
- To be sure you take maximum advantage of all the features this unit has to offer, read these instructions carefully and use the set properly. Be sure to keep this manual for future reference should any questions or problems arise.

**FCC DECLARATION OF CONFORMITY**

Type of equipment : Charger Base Station  
 Model : RC-8001ST  
 Manufacturer's authorized representative : DENON ELECTRONICS, a Division of Denon Corporation (U.S.A.)  
 19 Chapin Road, Pine Brook NJ07058 U.S.A., Tel: 973-396-0810

**TABLE OF CONTENTS**

<b>1</b> Features .....	2	<b>4</b> Connecting to Other Devices .....	3, 4
<b>2</b> Before Using .....	2	<b>5</b> Operation .....	5, 6
Loading the included nickel cadmium battery .....	2	<b>6</b> Specifications .....	6
<b>3</b> Names of Parts .....	3		

**1 FEATURES**

- RF reception and conversion to infra-red emitter output, when used in combination with the RC-8000. RF control is possible only when the RC-8001ST is used in combination with the RC-8000.
- Charging function (only when the RC-8000 and RC-8001ST are used in combination). The RC-8000 can be charged on the RC-8001ST only when using the included nickel cadmium battery pack. Do not attempt to charge the RC-8000 with alkaline baatteries installed, as battery leakage and overheating will occur, possibly damaging the unit.

**2 BEFORE USING**

**Loading the included nickel cadmium battery**

The supplied nickel cadmium battery is exclusively for use with the separately sold RC-8000 remote control transmitter.

Use the procedure described below to load the included nickel cadmium battery in the RC-8000.

- 1** Slide the battery cover on the rear of the RC-8000 to remove it.
- 2** Mount the battery holder, then stick the included spacer within the frame on the rear of the battery cover.
- 3** Insert the nickel cadmium battery supplied with the RC-8001ST, then connect the connector.
- 4** Close the battery cover.

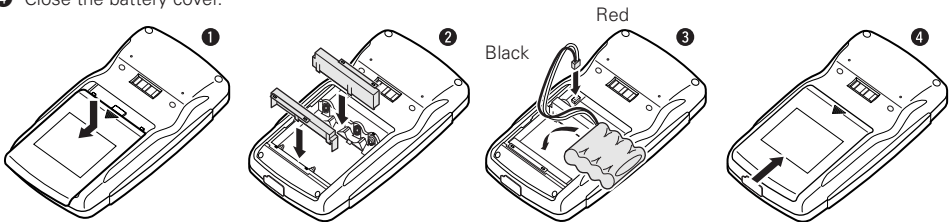

**NOTE:**

Do not charge the included nickel cadmium rechargeable battery pack with anything but the RC-8001ST. Also, do not use the RC-8001ST to charge anything but the included nickel cadmium rechargeable battery pack.

### 3 NAMES OF PARTS

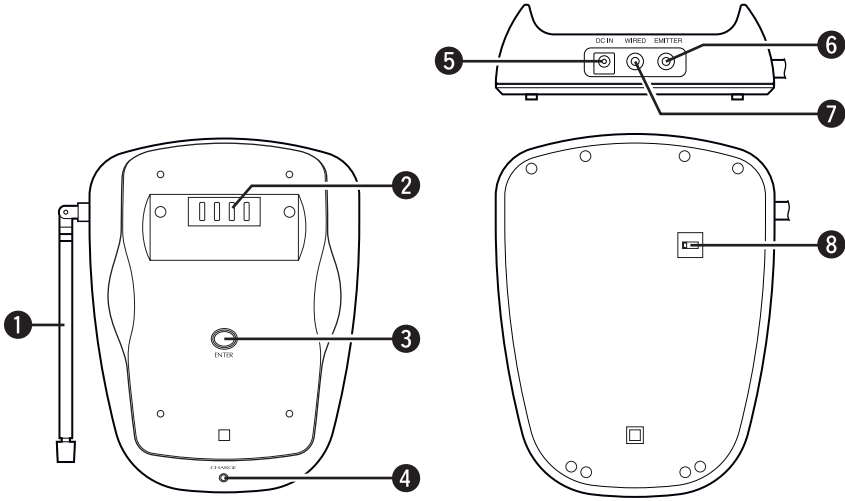

- 1 Antenna
- 2 Charging contacts
- 3 ENTER button
- 4 Charging indicator ("CHARGE")
- 5 DC IN terminal
- 6 EMITTER terminal
- 7 WIRED terminal
- 8 RF frequency select switch

### 4 CONNECTING TO OTHER DEVICES

#### Connecting to a Denon AV Receiver

Use the procedure described below to connect the RC-8001ST to a Denon AV receiver equipped with a REMOTE IN terminal.

- 1 Connect the included AC adapter to a wall power outlet, then connect the power cord to the RC-8001ST's DC IN terminal.
- 2 Using the supplied connection cord, connect the RC-8001ST's WIRED terminal to the receiver's REMOTE IN terminal.

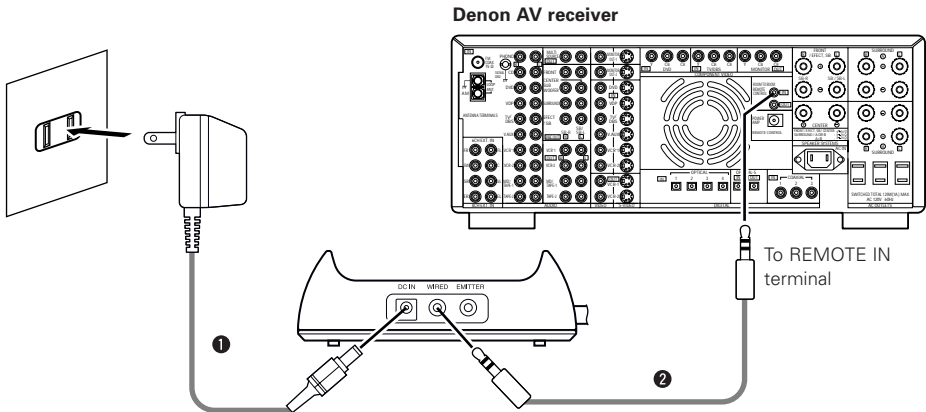

**Connecting to Other Devices**

Use the procedure described below to connect the RC-8001ST to a Denon device not equipped with a REMOTE IN terminal or to other devices.

- ❶ Connect the included AC adapter to a wall power outlet, then connect the power cord to the RC-8001ST's DC IN terminal.
- ❷ Connect a commercially available IR emitter (a Denon RC-618 for example) to the RC-8001ST's EMITTER terminal, then place the IR emitter near the device's remote control receiver in a position in which reception is possible.

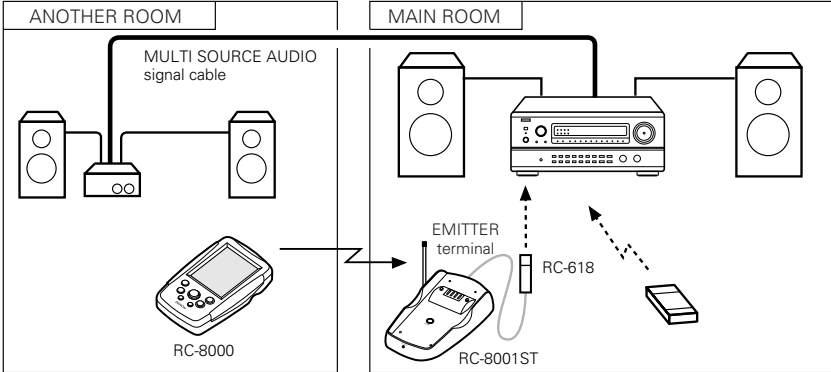

**Connecting Using a Denon RC-616**

The following shows an example for controlling multiple devices using a Denon RC-616 powered emitter.

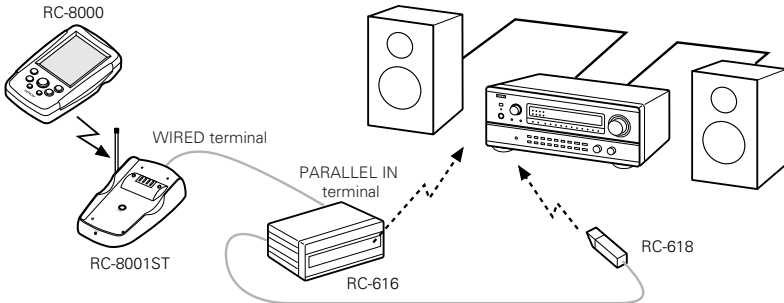

## 5 OPERATION

### About the RF Transmission Function

RF transmission is possible when the RC-8001ST is used in combination with the RC-8000 (included with the AVR-5800 or sold separately) remote control transmitter.

With this function it is possible to operate your components from another room in your home, or to operate your components if they are in an enclosed cabinet not conveniently nearby, etc.

### Procedure for RF Transmission

To conduct RF transmission, change the setting of the RC-8000 remote control transmitter to RF using the procedure described below.

- 1 Press the "SETUP" icon in the icon display section for at least 3 seconds to display the setup screen. Press the "RF/IR Select" button on the "Setup 4/4" page to display the RF/IR selection screen.
- 2 Use the  $\blacktriangle$  and  $\blacktriangledown$  buttons on the device name list to display the device for which you want to perform RF transmission. Press the icon for that device to switch the setting from IR to RF. Press the "OK" button to complete the setting and return to the setup screen.

\* The setting switches between RF and IR each time the button is pressed while it is displayed with a half-tone dot mesh.

At the setup screen, press the icon for the device set to RF to display the remote control signal transmission screen and perform RF transmission.

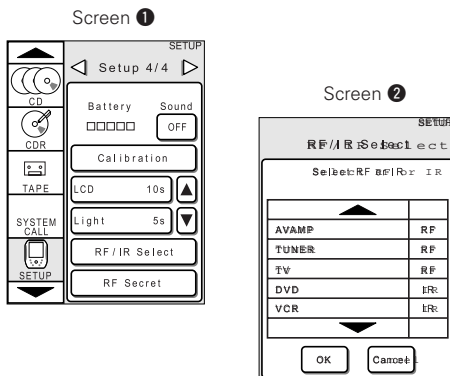

### RF Transmission Frequency

Interference may cause operation to be unstable when conducting RF transmission.

In such cases, change the RF transmission frequency.

When changing the RF transmission frequency, set the RC-8001ST and the RC-8000 remote control transmitter to the same position (RF 1 or 2).

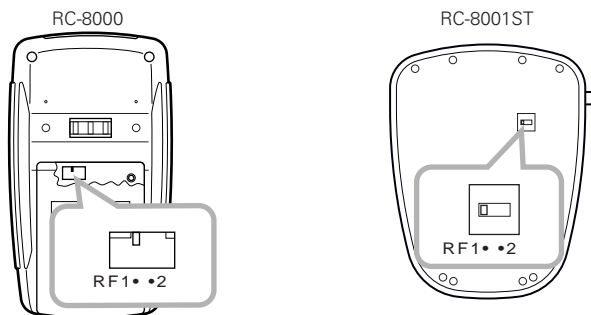

**RF Secret Number**

When using the RF transmission function with multiple pairs of RC-8000 and RC-8001ST, inadvertent operations could occur if the same RF transmission frequency is shared. If so, set different RF secret numbers for the different pairs.

**Registering secret numbers**

- 1 Press the "SETUP" icon in the RC-8000's icon display section for at least 3 seconds to display the setup screen. Press the "RF Secret" button on the "Setup 4/4" page to display the RF secret number registration screen.
- 2 Press the number buttons on the RF secret number registration screen to register that number in the RC-8000. The selected number is highlighted.
- 3 While pressing the ENTER button on the RC-8001ST, press the "Transmit" button on the RC-8000. The number registered in the RC-8000 is registered in the RC-8001ST as well, then the setup screen reappears.

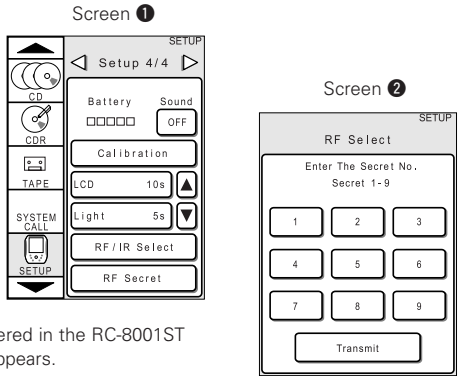

**Charging Function**

The RC-8000's nickel cadmium battery can be charged by placing the RC-8000 on the RC-8001ST. Charge the battery pack if "LOW BATTERY" appears on the remote control unit's display. Be sure to charge the nickel cadmium rechargeable battery pack for about 8 hours before connecting it to the remote control unit and using it to power the remote control unit. During charging, the charging indicator ("CHARGE") lights. The indicator turns off once charging is completed. Approximately 8 hours (at 70 mA) are required to charge the nickel cadmium battery.

**6 SPECIFICATIONS**

Rechargeable battery:	4.8 V nickel cadmium rechargeable battery pack (included with RC-8001ST)	
Dimensions:	132 mm (width) x 42 mm (height) x 160 mm (depth) (5-13/64" x 1-21/32" x 6-19/64")	
Mass:	170 g (6 oz)	
Accessories:	Nickel cadmium battery pack.....1	Warranty *.....1
	AC adapter (AA-25).....1	Service station list.....1
	Connection cord.....1	Spacer.....1
	Battery holder.....2	
	Operating instructions.....1	

\* When the RC-8001ST is acquired as an accessory included with the AVR-5800, there is no separate warranty for the RC-8001ST. (The warranty is only for the AVR-5800.)

\* For purposes of improvement, specifications and design are subject to change without notice.

**RECYCLING NICKEL-CADMIUM BATTERIES**



**NICKEL-CADMIUM BATTERIES MUST BE RECYCLED OR DISPOSED OF PROPERLY.**

Nickel-cadmium cells are used in the battery pack. Please take your used nickel-cadmium battery packs to a store that recycles nickel-cadmium batteries.

- Cautions:**
- Use the specified battery pack.
  - Never throw the battery into a fire, disassemble it, or heat it.
  - Do not remove or damage the battery casing.

## Free Manuals Download Website

<http://myh66.com>

<http://usermanuals.us>

<http://www.somanuals.com>

<http://www.4manuals.cc>

<http://www.manual-lib.com>

<http://www.404manual.com>

<http://www.luxmanual.com>

<http://aubethermostatmanual.com>

Golf course search by state

<http://golfingnear.com>

Email search by domain

<http://emailbydomain.com>

Auto manuals search

<http://auto.somanuals.com>

TV manuals search

<http://tv.somanuals.com>