

Dell Vostro 3252 Owner's Manual

Regulatory Model: D14S
Regulatory Type: D14S001



Notes, cautions, and warnings

 **NOTE:** A NOTE indicates important information that helps you make better use of your computer.

 **CAUTION:** A CAUTION indicates either potential damage to hardware or loss of data and tells you how to avoid the problem.

 **WARNING:** A WARNING indicates a potential for property damage, personal injury, or death.

Copyright © 2015 Dell Inc. All rights reserved. This product is protected by U.S. and international copyright and intellectual property laws. Dell™ and the Dell logo are trademarks of Dell Inc. in the United States and/or other jurisdictions. All other marks and names mentioned herein may be trademarks of their respective companies.

2015 - 08

Rev. A00

Contents

1 Working on Your Computer.....	5
Before Working Inside Your Computer.....	5
Turning Off Your Computer.....	6
After Working Inside Your Computer.....	7
2 Removing and Installing Components.....	8
Recommended Tools.....	8
Removing the Cover.....	8
Installing the Cover.....	9
Removing the Front Bezel.....	9
Installing the Front Bezel.....	9
Removing the Memory.....	9
Installing the Memory.....	10
Removing the Coin-Cell Battery.....	10
Installing the Coin-Cell Battery.....	10
Removing the Hard-Drive Assembly.....	10
Installing the Hard-Drive Assembly.....	12
Removing the Optical Drive.....	12
Installing the Optical Drive.....	14
Removing the Heatsink Assembly.....	14
Installing the Heatsink Assembly.....	15
Removing the WLAN Card.....	15
Installing the WLAN Card.....	16
System Board Layout.....	16
Removing the System Board.....	17
Installing the System Board.....	18
3 Troubleshooting Your Computer.....	20
Diagnostic Power LED Codes.....	20
Diagnostic Error Messages.....	21
System Error Messages.....	25
4 System Setup Overview.....	26
Accessing System Setup.....	26
System Setup Options.....	26
5 Specifications.....	30

6 Contacting Dell.....33

Working on Your Computer

Before Working Inside Your Computer

Use the following safety guidelines to help protect your computer from potential damage and to help to ensure your personal safety. Unless otherwise noted, each procedure included in this document assumes that the following conditions exist:

- You have read the safety information that shipped with your computer.
- A component can be replaced or--if purchased separately--installed by performing the removal procedure in reverse order.

 **WARNING:** Disconnect all power sources before opening the computer cover or panels. After you finish working inside the computer, replace all covers, panels, and screws before connecting to the power source.

 **WARNING:** Before working inside your computer, read the safety information that shipped with your computer. For additional safety best practices information, see the Regulatory Compliance Homepage at www.dell.com/regulatory_compliance

 **CAUTION:** Many repairs may only be done by a certified service technician. You should only perform troubleshooting and simple repairs as authorized in your product documentation, or as directed by the online or telephone service and support team. Damage due to servicing that is not authorized by Dell is not covered by your warranty. Read and follow the safety instructions that came with the product.

 **CAUTION:** To avoid electrostatic discharge, ground yourself by using a wrist grounding strap or by periodically touching an unpainted metal surface, such as a connector on the back of the computer.

 **CAUTION:** Handle components and cards with care. Do not touch the components or contacts on a card. Hold a card by its edges or by its metal mounting bracket. Hold a component such as a processor by its edges, not by its pins.

 **CAUTION:** When you disconnect a cable, pull on its connector or on its pull-tab, not on the cable itself. Some cables have connectors with locking tabs; if you are disconnecting this type of cable, press in on the locking tabs before you disconnect the cable. As you pull connectors apart, keep them evenly aligned to avoid bending any connector pins. Also, before you connect a cable, ensure that both connectors are correctly oriented and aligned.

 **NOTE:** The color of your computer and certain components may appear differently than shown in this document.

To avoid damaging your computer, perform the following steps before you begin working inside the computer.

1. Ensure that your work surface is flat and clean to prevent the computer cover from being scratched.
2. Turn off your computer (see Turning Off Your Computer).







 **CAUTION: To disconnect a network cable, first unplug the cable from your computer and then unplug the cable from the network device.**

3. Disconnect all network cables from the computer.
4. Disconnect your computer and all attached devices from their electrical outlets.
5. Press and hold the power button while the computer is unplugged to ground the system board.
6. Remove the cover.

 **CAUTION: Before touching anything inside your computer, ground yourself by touching an unpainted metal surface, such as the metal at the back of the computer. While you work, periodically touch an unpainted metal surface to dissipate static electricity, which could harm internal components.**

Turning Off Your Computer

 **CAUTION: To avoid losing data, save and close all open files and exit all open programs before you turn off your computer.**

1. Shut down the operating system:
 - In Windows 8.1:
 - Using a touch-enabled device:
 - a. Swipe in from the right edge of the screen, opening the Charms menu and select **Settings**.
 - b. Select the  and then select **Shut down**.
 - Or
 - * On the Home screen, touch the  and then select **Shut down**.
 - Using a mouse:
 - a. Point to upper-right corner of the screen and click **Settings**.
 - b. Click the  and select **Shut down**.
 - Or
 - * On the Home screen, click  and then select **Shut down**.
 - In Windows 7:
 1. Click **Start** .
 2. Click **Shut Down**.
 - or
 1. Click **Start** .

2. Click the arrow in the lower-right corner of the **Start** menu as shown below, and then click



Shut Down

2. Ensure that the computer and all attached devices are turned off. If your computer and attached devices did not automatically turn off when you shut down your operating system, press and hold the power button for about 6 seconds to turn them off.

After Working Inside Your Computer

After you complete any replacement procedure, ensure you connect any external devices, cards, and cables before turning on your computer.

1. Replace the cover.

 **CAUTION: To connect a network cable, first plug the cable into the network device and then plug it into the computer.**

2. Connect any telephone or network cables to your computer.
3. Connect your computer and all attached devices to their electrical outlets.
4. Turn on your computer.
5. If required, verify that the computer works correctly by running the Dell Diagnostics.

Removing and Installing Components

This section provides detailed information on how to remove or install the components from your computer.

Recommended Tools

The procedures in this document may require the following tools:

- Small flat-blade screwdriver
- Phillips screwdriver
- Small plastic scribe

Removing the Cover

1. Follow the procedures in [Before Working Inside Your Computer](#).
2. Follow the steps to remove the cover:
 - a. Remove the screws that secure the cover to the computer [1].
 - b. Slide the computer cover towards the back of the computer [2].
 - c. Lift and remove the cover from the computer [3].

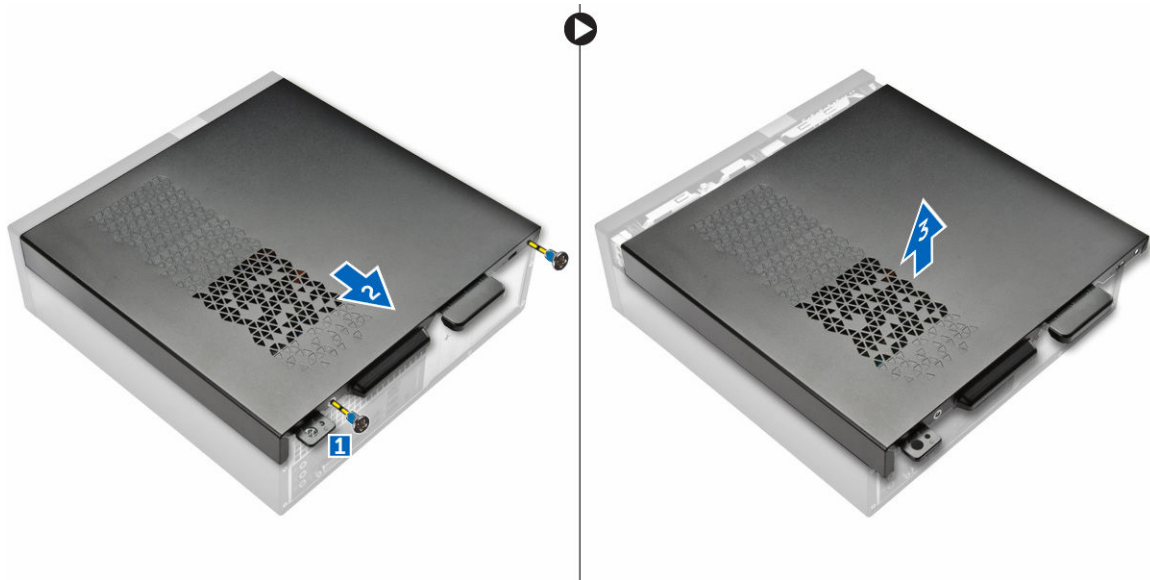

Installing the Cover

1. Slide the cover from the back of the computer, until the latches snap-in.
2. Tighten the screws to secure the cover.
3. Follow the procedures in [After Working Inside Your Computer](#)

Removing the Front Bezel

1. Follow the procedures in [Before Working Inside Your Computer](#).
2. Remove [cover](#).
3. Follow the steps to remove the cover:
 - a. Lift the retention clips [1] and release the front bezel [2].
 - b. Lift up the front bezel to remove it from the computer [3].

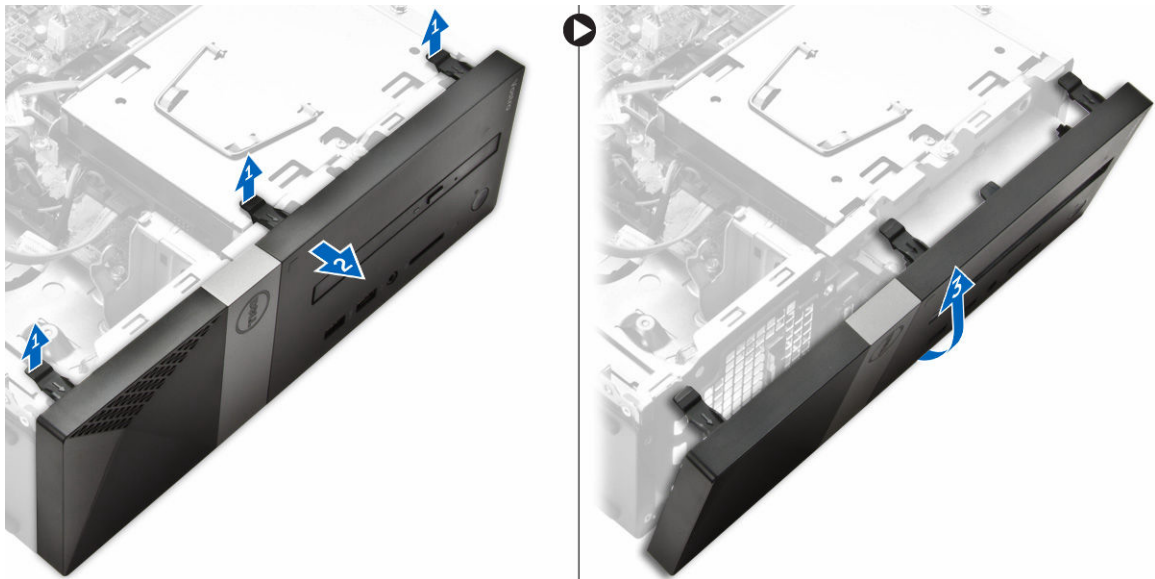

Installing the Front Bezel

1. Hold the bezel and ensure that the hooks on the bezel snap into the notches on the computer.
2. Rotate the front bezel toward the computer.
3. Press the front bezel until the tabs snap in.
4. Install the [cover](#).
5. Follow the procedures in [After Working Inside Your Computer](#).

Removing the Memory

1. Follow the procedures in [Before Working Inside Your Computer](#).
2. Remove the [cover](#).
3. Pry the securing clips away from the memory module until it pops up. Remove the memory module from its socket on the system board.

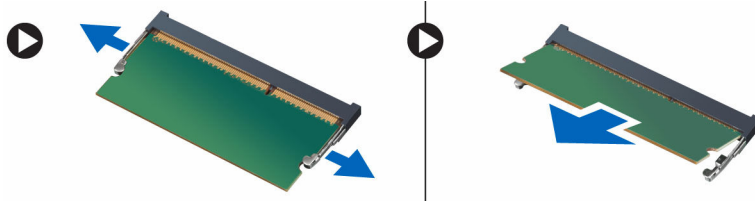

Installing the Memory

1. Align the notch on the memory card with the tab in the memory connector.
2. Insert the memory module into the memory socket and press until it clicks into place
3. Install the [cover](#).
4. Follow the procedures in [After Working Inside Your Computer](#).

Removing the Coin-Cell Battery

1. Follow the procedures in [Before Working Inside Your Computer](#).
2. Remove the [cover](#).
3. Press the release-latch and the coin-cell battery pops out. Lift the coin-cell battery out of the computer.

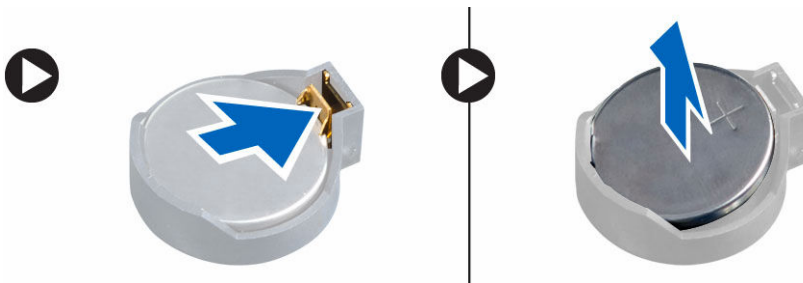

Installing the Coin-Cell Battery

1. Place the coin-cell battery into its slot on the system board.
2. Press the coin-cell battery downward until the release latch springs back into place and secures it.
3. Install the [cover](#).
4. Follow the procedures in [After Working Inside Your Computer](#).

Removing the Hard-Drive Assembly

1. Follow the procedures in [Before Working Inside Your Computer](#).
2. Remove:
 - a. [cover](#)
 - b. [front bezel](#)
3. Disconnect the power and the data cables from the hard drive.

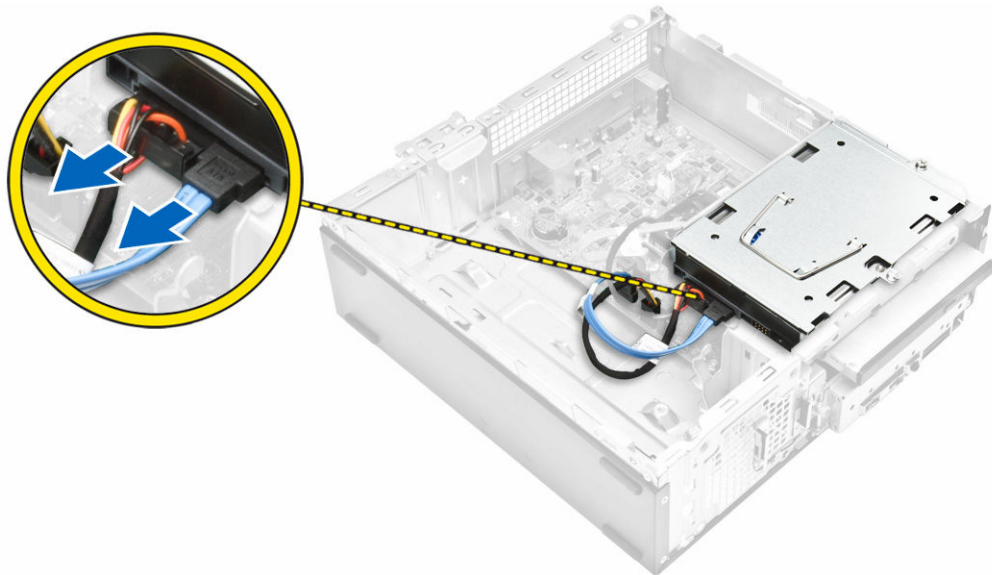

4. Follow the steps to remove the hard-drive assembly:
 - a. Remove the screws that secure the hard drive to the drive bay [1].
 - b. Lift the drive bay handle [2] and slide it from the drive bay [3].

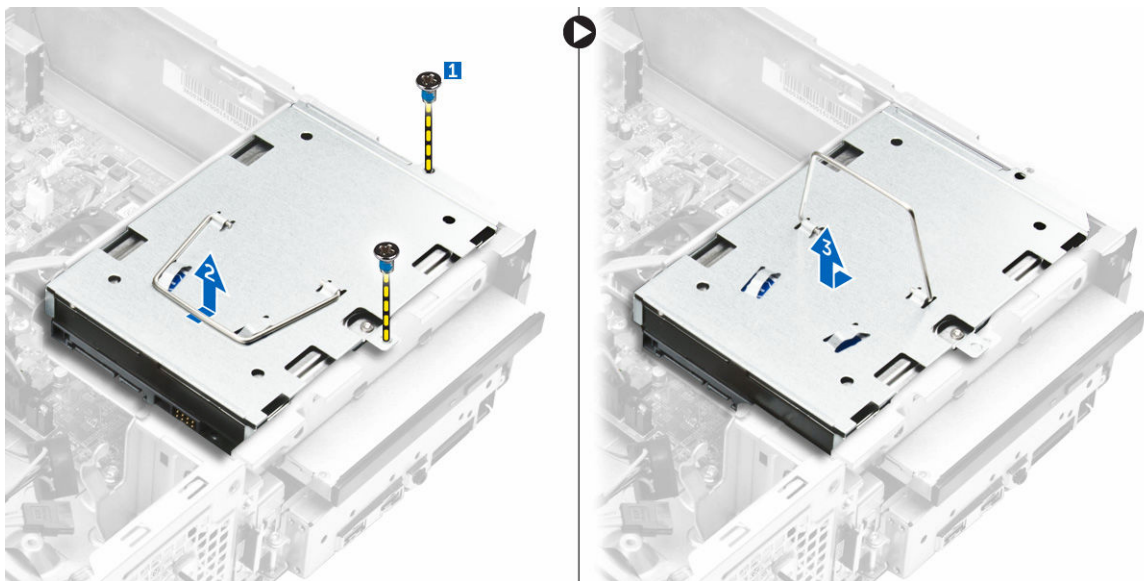

5. Follow the steps to remove hard-drive bracket:
 - a. Remove the screws that secure the hard drive to the bracket [1].
 - b. Slide the hard-drive from the bracket [2].

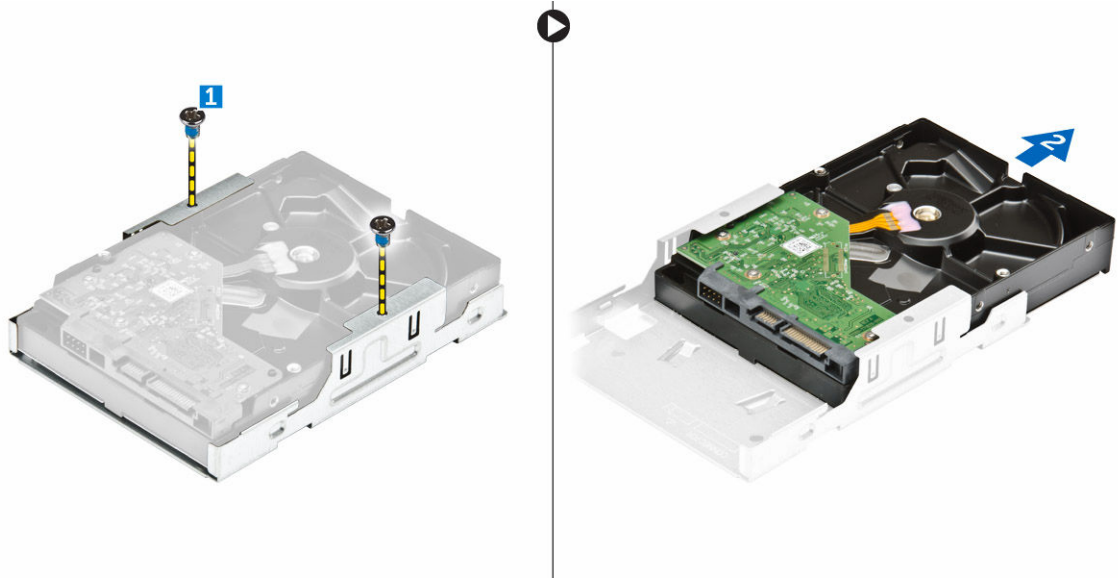

 **NOTE:** Remove the hard-drive bracket only if you are replacing with a new hard drive. Otherwise, if hard drive removal is only a pre-requisite to remove other components, then ignore Step 5.

Installing the Hard-Drive Assembly

1. Slide the hard drive into the bracket.
2. Tighten the screws to secure the hard drive to the bracket.
3. Holding the handle, slide the hard-drive assembly into the drive bay.
4. Tighten the screws to secure the hard-drive assembly to the computer.
5. Connect the data and power cables to the hard drive.
6. Install:
 - a. [front bezel](#)
 - b. [cover](#)
7. Follow the procedures in [After Working Inside Your Computer](#).

Removing the Optical Drive

1. Follow the procedures in [Before Working Inside Your Computer](#).
2. Remove:
 - a. [cover](#)
 - b. [front bezel](#)
 - c. [hard-drive assembly](#)
3. Follow the steps to release the optical drive:
 - a. Disconnect the power and the data cables from the optical drive [1].
 - b. Remove the screw that secures the optical drive to the drive bay [2].

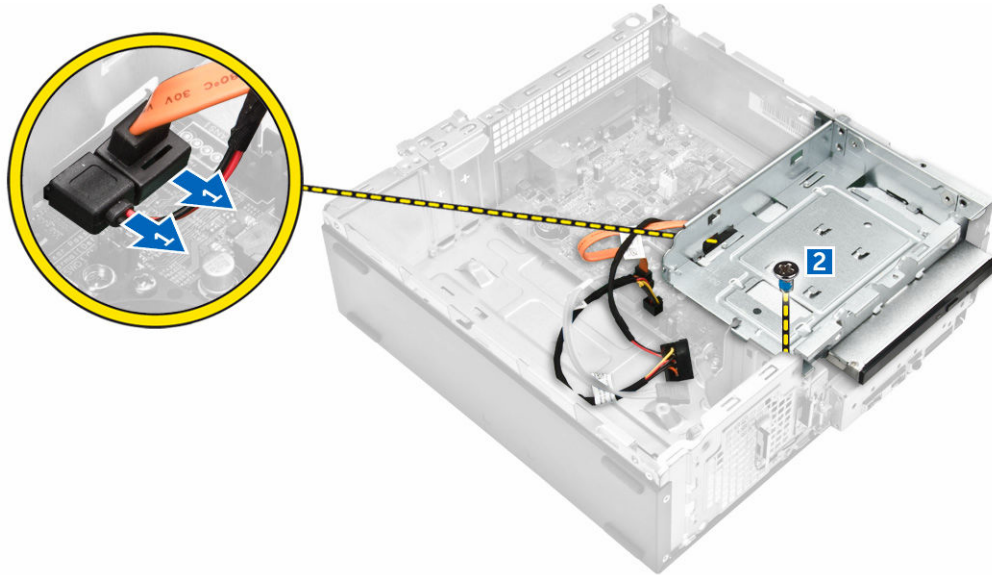

4. Follow the steps to remove the optical drive:
 - a. Press the blue tab to loosen the optical drive [1].
 - b. Slide the optical drive [2] and lift it up to remove it from the chassis [3].

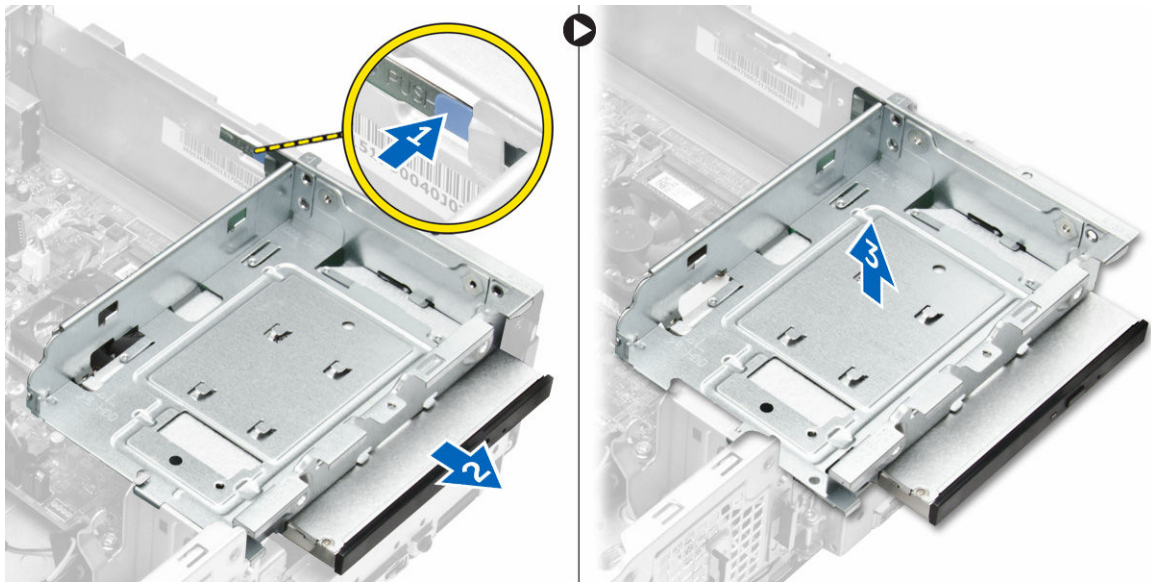

5. Follow the steps to remove the bracket from the optical drive.
 - a. Remove the screws that secure the bracket to the optical drive.
 - b. Slide the optical drive from the bracket.

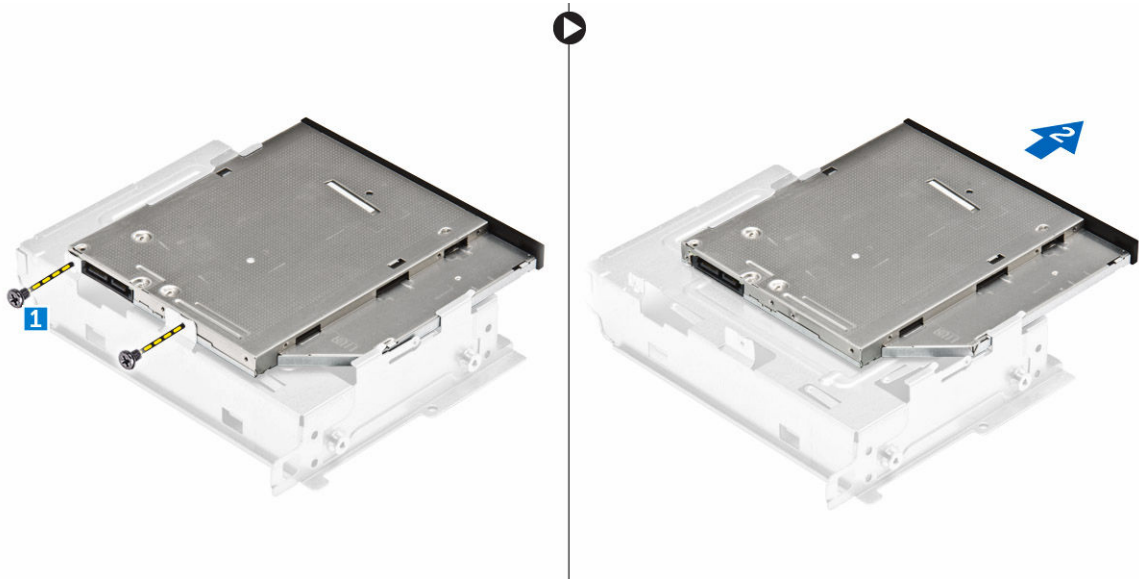

 **NOTE:** Remove the optical-drive bracket only if you are replacing with a new optical drive. Otherwise, if optical drive removal is only a pre-requisite to remove other components, then ignore Step 5 and Step 6.

Installing the Optical Drive

1. Slide the optical drive into the drive bay until it snaps.
2. Tighten the screw to secure the drive to the chassis.
3. Connect the data and power cables to the optical drive.
4. Install:
 - a. [hard-drive assembly](#)
 - b. [front bezel](#)
 - c. [cover](#)
5. Follow the procedures in [After Working Inside Your Computer](#).

Removing the Heatsink Assembly

1. Follow the procedures in [Before Working Inside Your Computer](#).
2. Remove:
 - a. [cover](#)
 - b. [front bezel](#)
 - c. [hard-drive assembly](#)
 - d. [optical drive](#)
3. Follow the steps to remove the heatsink assembly:
 - a. Disconnect the heatsink assembly cable from the system board [1].
 - b. Remove the screws to release the processor fan and the heatsink [2].
 - c. Lift up the heatsink and remove it from the chassis [3].

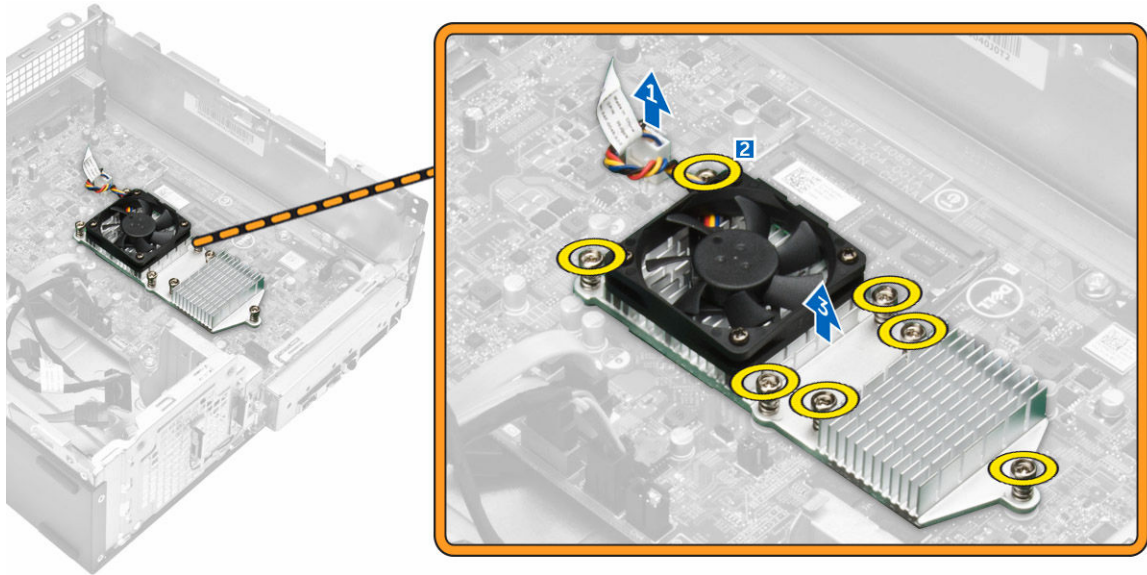

Installing the Heatsink Assembly

1. Place the heatsink assembly in the slot by aligning with the screw holes.
2. Tighten the screws to secure the heatsink assembly to the system board.
3. Connect the heatsink-assembly cable to the system board.
4. Install:
 - a. [optical drive](#)
 - b. [hard-drive assembly](#)
 - c. [front bezel](#)
 - d. [cover](#)
5. Follow the procedures in [After Working Inside Your Computer](#).

Removing the WLAN Card

1. Follow the procedures in [Before Working Inside Your Computer](#).
2. Remove:
 - a. [cover](#)
 - b. [front bezel](#)
3. Follow the steps to remove the WLAN card:
 - a. Slide the WLAN antenna cable cover from the cables [1].
 - b. Remove the screw that secures the WLAN card to the system board.
 - c. Disconnect the antenna cables from the WLAN card.
 - d. Pull the WLAN card from the connector on the system board.

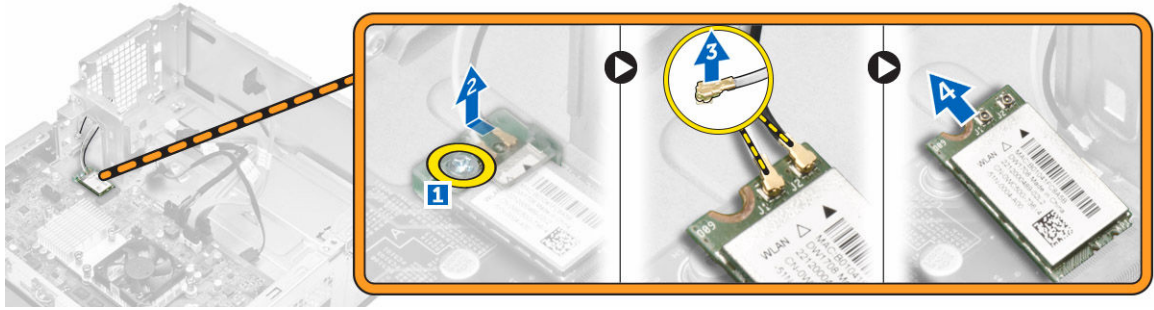

Installing the WLAN Card

1. Slide the WLAN card to install it on the system board connector.
2. Connect the antenna cables to the WLAN card
3. Tighten the screw to secure the WLAN to system board.
4. Install [cover](#).
5. Follow the procedures in [After Working Inside Your Computer](#).

System Board Layout

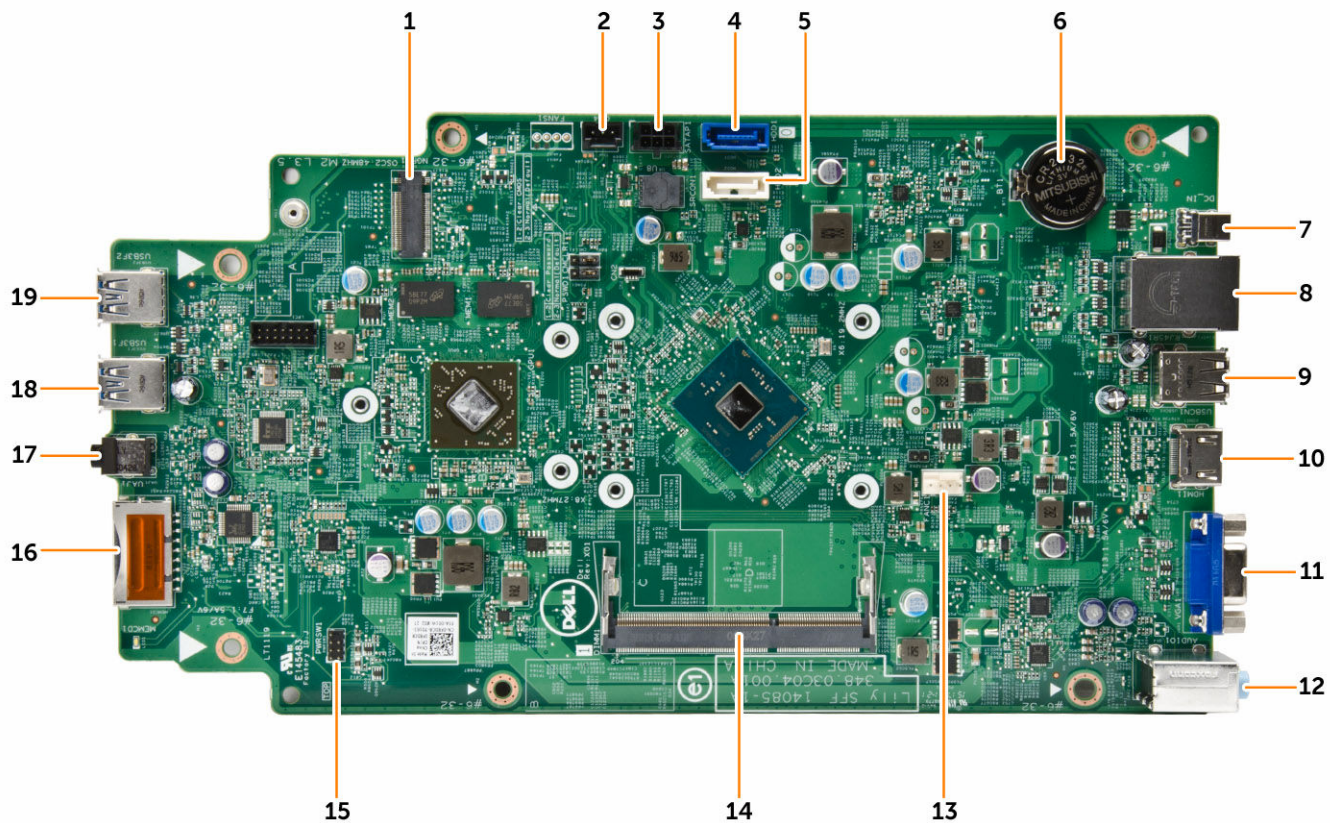

- | | |
|----------------------------|---|
| 1. NGFF connector | 2. Light bar connector |
| 3. SATA power connector | 4. SATA connector |
| 5. SATA connector | 6. Coin-cell battery |
| 7. DC-In jack | 8. Network and USB 2.0 connectors (2) |
| 9. USB 2.0 connectors (2) | 10. HDMI connector |
| 11. VGA connector | 12. Line-in, line-out and microphone connectors |
| 13. Fan connector | 14. Memory slot |
| 15. Power-switch connector | 16. SD card connector |
| 17. Headset jack | 18. USB 3.0 connector |
| 19. USB 3.0 connector | |

Removing the System Board

1. Follow the procedures in [Before Working Inside Your Computer](#).
2. Remove:
 - a. [cover](#)
 - b. [front bezel](#)
 - c. [hard-drive assembly](#)
 - d. [optical drive](#)
 - e. [coin-cell battery](#)
 - f. [heatsink assembly](#)
 - g. [WLAN card](#)
3. Disconnect the cables from the system board:

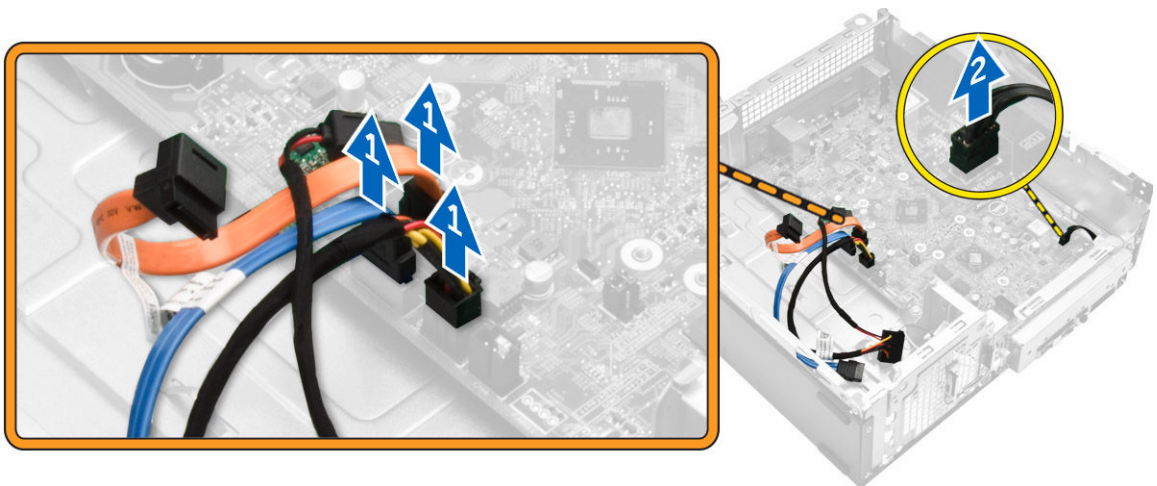

4. Follow the steps to release the I/O panel:
 - a. Remove the screw that secures the I/O panel to the chassis [1].
 - b. Press the tab to release the I/O panel from the chassis [2].
 - c. Pull the I/O panel to release the I/O panel.

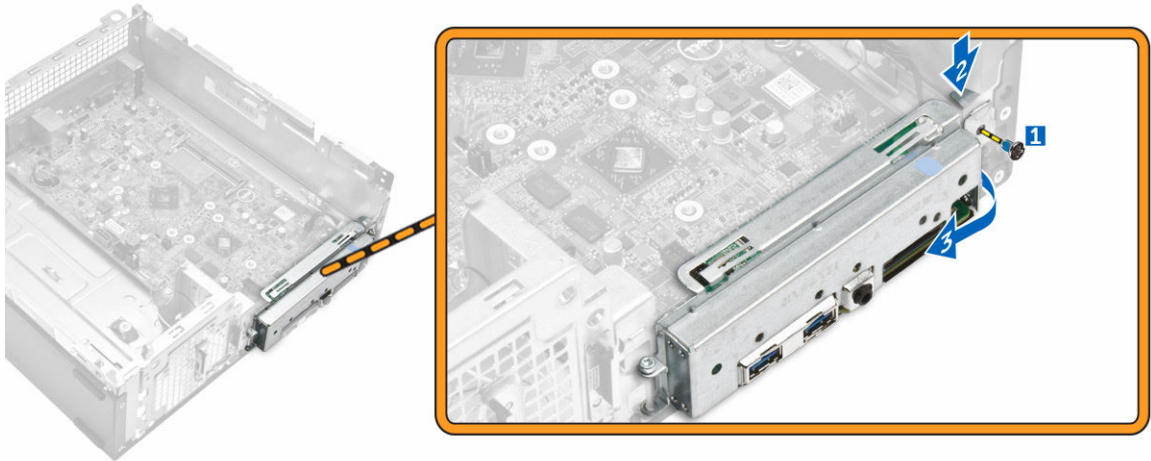

5. Follow the steps to remove the system board:
 - a. Remove the screws that secure system board to the chassis [1].
 - b. Lift the system board from the chassis.

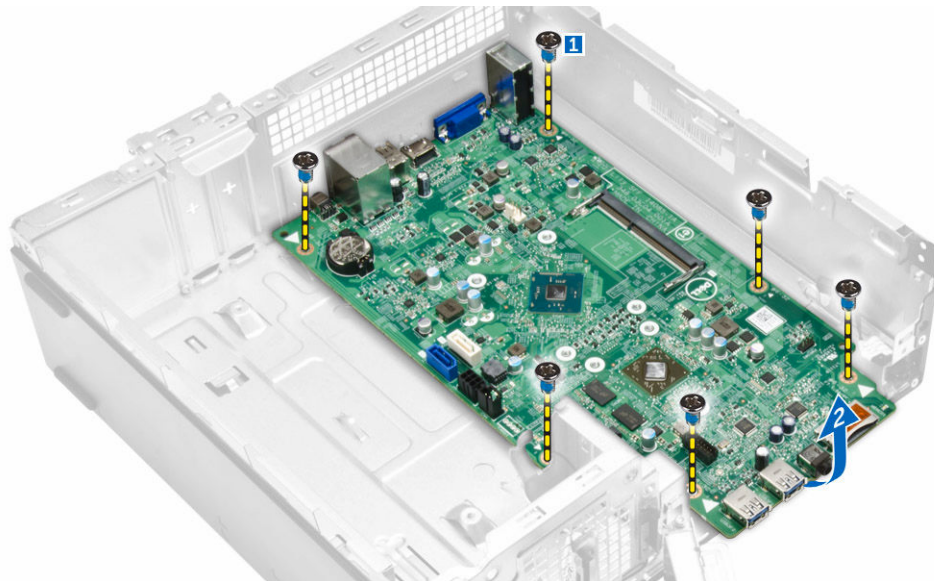

Installing the System Board

1. Insert the system board and ensure that ports are aligned to the holes on the back panel.
2. Push the I/O panel to its original position until it snaps in.
3. Tighten the screw to secure the I/O panel to the chassis.
4. Connect the cables to the system board.
5. Install:
 - a. [WLAN card](#)
 - b. [heatsink assembly](#)
 - c. [coin-cell battery](#)
 - d. [optical-drive assembly](#)

- e. [hard-drive assembly](#)
 - f. [front bezel](#)
 - g. [cover](#)
6. Follow the procedures in [After Working Inside Your Computer](#).

Troubleshooting Your Computer

You can troubleshoot your computer using indicators like Diagnostic Lights, Beep Codes, and Error Messages during the operation of the computer.

Diagnostic Power LED Codes

Table 1. Diagnostic power LED codes

Power LED Light Status	Possible Cause	Troubleshooting Steps
Off	The computer is either turned off or is not receiving power or in Hibernation mode.	<ul style="list-style-type: none"> • Re-seat the power cable in the power connector on the back of the computer and the electrical outlet. • If the computer is plugged into a power strip, ensure the power strip is plugged into an electrical outlet and is turned on. Also, bypass power protection devices, power strips, and power extension cables to verify the computer turns on properly. • Ensure the electrical outlet is working by testing it with another device, such as a lamp.
Steady / Blinking / Amber	Computer fails to complete POST or processor failure.	<ul style="list-style-type: none"> • Remove and then reinstall any cards. • Remove and then reinstall the graphics card, if applicable. • Ensure the power cable is connected to the motherboard and processor.
Blinking / White / Light	Computer is in sleep mode.	<ul style="list-style-type: none"> • Press the power button to bring the computer out of the sleep mode. • Ensure all power cables are securely connected to the system board. • Ensure the main power cable and front panel cable are securely connected to the system board.
Steady / White	The computer is fully functional and in the On state.	<p>If the computer is not responding, do the following:</p> <ul style="list-style-type: none"> • Ensure the display is connected and turned on. • If the display is connected and turned on, listen for a beep code.

Diagnostic Error Messages

Table 2. Diagnostic error messages

Error Messages	Description
AUXILIARY DEVICE FAILURE	The touchpad or external mouse may be faulty. For an external mouse, check the cable connection. Enable the Pointing Device option in the system setup program.
BAD COMMAND OR FILE NAME	Ensure that you have spelled the command correctly, put spaces in the proper place, and used the correct pathname.
CACHE DISABLED DUE TO FAILURE	The primary cache internal to the microprocessor has failed. Contact Dell .
CD DRIVE CONTROLLER FAILURE	The optical drive does not respond to commands from the computer.
DATA ERROR	The hard drive cannot read the data.
DECREASING AVAILABLE MEMORY	One or more memory modules may be faulty or improperly seated. Reinstall the memory modules or, if necessary, replace them.
DISK C: FAILED INITIALIZATION	The hard drive failed initialization. Run the hard drive tests in the Dell Diagnostics.
DRIVE NOT READY	The operation requires a hard drive in the bay before it can continue. Install a hard drive in the hard drive bay.
ERROR READING PCMCIA CARD	The computer cannot identify the ExpressCard. Reinsert the card or try another card.
EXTENDED MEMORY SIZE HAS CHANGED	The amount of memory recorded in non-volatile memory (NVRAM) does not match the memory installed in the computer. Restart the computer. If the error appears again, Contact Dell
THE FILE BEING COPIED IS TOO LARGE FOR THE DESTINATION DRIVE	The file that you are trying to copy is too large to fit on the disk, or the disk is full. Try copying the file to a different disk or use a larger capacity disk.
A FILENAME CANNOT CONTAIN ANY OF THE FOLLOWING CHARACTERS: \ / : * ? " < > -	Do not use these characters in filenames.
GATE A20 FAILURE	A memory module may be loose. Reinstall the memory modules or, if necessary, replace them.
GENERAL FAILURE	The operating system is unable to carry out the command. The message is usually followed by specific information. For example, Printer out of paper. Take the appropriate action.

Error Messages	Description
HARD-DISK DRIVE CONFIGURATION ERROR	The computer cannot identify the drive type. Shut down the computer, remove the hard drive, and boot the computer from an optical drive. Then, shut down the computer, reinstall the hard drive, and restart the computer. Run the Hard Disk Drive tests in the Dell Diagnostics.
HARD-DISK DRIVE CONTROLLER FAILURE 0	The hard drive does not respond to commands from the computer. Shut down the computer, remove the hard drive, and boot the computer from an optical drive. Then, shut down the computer, reinstall the hard drive, and restart the computer. If the problem persists, try another drive. Run the Hard Disk Drive tests in the Dell Diagnostics.
HARD-DISK DRIVE FAILURE	The hard drive does not respond to commands from the computer. Shut down the computer, remove the hard drive, and boot the computer from an optical drive. Then, shut down the computer, reinstall the hard drive, and restart the computer. If the problem persists, try another drive. Run the Hard Disk Drive tests in the Dell Diagnostics .
HARD-DISK DRIVE READ FAILURE	The hard drive may be defective. Shut down the computer, remove the hard drive, and boot the computer from an optical. Then, shut down the computer, reinstall the hard drive, and restart the computer. If the problem persists, try another drive. Run the Hard Disk Drive tests in the Dell Diagnostics.
INSERT BOOTABLE MEDIA	The operating system is trying to boot to non-bootable media, such as a floppy disk or optical drive. Insert bootable media.
INVALID CONFIGURATION INFORMATION-PLEASE RUN SYSTEM SETUP PROGRAM	The system configuration information does not match the hardware configuration. The message is most likely to occur after a memory module is installed. Correct the appropriate options in the system setup program.
KEYBOARD CLOCK LINE FAILURE	For external keyboards, check the cable connection. Run the Keyboard Controller test in the Dell Diagnostics .
KEYBOARD CONTROLLER FAILURE	For external keyboards, check the cable connection. Restart the computer, and avoid touching the keyboard or the mouse during the boot routine. Run the Keyboard Controller test in the Dell Diagnostics .

Error Messages	Description
KEYBOARD DATA LINE FAILURE	For external keyboards, check the cable connection. Run the Keyboard Controller test in the Dell Diagnostics .
KEYBOARD STUCK KEY FAILURE	For external keyboards or keypads, check the cable connection. Restart the computer, and avoid touching the keyboard or keys during the boot routine. Run the Stuck Key test in the Dell Diagnostics .
LICENSED CONTENT IS NOT ACCESSIBLE IN MEDIADIRECT	Dell MediaDirect cannot verify the Digital Rights Management (DRM) restrictions on the file, so the file cannot be played.
MEMORY ADDRESS LINE FAILURE AT ADDRESS, READ VALUE EXPECTING VALUE	A memory module may be faulty or improperly seated. Reinstall the memory modules or, if necessary, replace them.
MEMORY ALLOCATION ERROR	The software you are attempting to run is conflicting with the operating system, another program, or a utility. Shut down the computer, wait 30 seconds, and then restart it. Try to run the program again. If the error message still appears, see the software documentation.
MEMORY DOUBLE WORD LOGIC FAILURE AT ADDRESS, READ VALUE EXPECTING VALUE	A memory module may be faulty or improperly seated. Reinstall the memory modules or, if necessary, replace them.
MEMORY ODD/EVEN LOGIC FAILURE AT ADDRESS, READ VALUE EXPECTING VALUE	A memory module may be faulty or improperly seated. Reinstall the memory modules or, if necessary, replace them.
MEMORY WRITE/READ FAILURE AT ADDRESS, READ VALUE EXPECTING VALUE	A memory module may be faulty or improperly seated. Reinstall the memory modules or, if necessary, replace them.
NO BOOT DEVICE AVAILABLE	The computer cannot find the hard drive. If the hard drive is your boot device, ensure that the drive is installed, properly seated, and partitioned as a boot device.
NO BOOT SECTOR ON HARD DRIVE	The operating system may be corrupted, Contact Dell .
NO TIMER TICK INTERRUPT	A chip on the system board may be malfunctioning. Run the System Set tests in the Dell Diagnostics .
NOT ENOUGH MEMORY OR RESOURCES. EXIT SOME PROGRAMS AND TRY AGAIN	You have too many programs open. Close all windows and open the program that you want to use.
OPERATING SYSTEM NOT FOUND	Reinstall the hard drive. If the problem persists, Contact Dell .

Error Messages	Description
OPTIONAL ROM BAD CHECKSUM	The optional ROM has failed. Contact Dell .
SECTOR NOT FOUND	The operating system cannot locate a sector on the hard drive. You may have a defective sector or corrupted FAT on the hard drive. Run the Windows error-checking utility to check the file structure on the hard drive. See Windows Help and Support for instructions (click Start > Help and Support). If a large number of sectors are defective, back up the data (if possible), and then reformat the hard drive.
SEEK ERROR	The operating system cannot find a specific track on the hard drive.
SHUTDOWN FAILURE	A chip on the system board may be malfunctioning. Run the System Set tests in the Contact Dell .
TIME-OF-DAY CLOCK LOST POWER	System configuration settings are corrupted. Connect your computer to an electrical outlet to charge the battery. If the problem persists, try to restore the data by entering the system setup program, then immediately exit the program. If the message reappears, Contact Dell .
TIME-OF-DAY CLOCK STOPPED	The reserve battery that supports the system configuration settings may require recharging. Connect your computer to an electrical outlet to charge the battery. If the problem persists, Contact Dell .
TIME-OF-DAY NOT SET-PLEASE RUN THE SYSTEM SETUP PROGRAM	The time or date stored in the system setup program does not match the system clock. Correct the settings for the Date and Time options.
TIMER CHIP COUNTER 2 FAILED	A chip on the system board may be malfunctioning. Run the System Set tests in the Dell Diagnostics .
UNEXPECTED INTERRUPT IN PROTECTED MODE	The keyboard controller may be malfunctioning, or a memory module may be loose. Run the System Memory tests and the Keyboard Controller test in the System Setup or Contact Dell .
X:\ IS NOT ACCESSIBLE. THE DEVICE IS NOT READY	Insert a disk into the drive and try again.

System Error Messages

Table 3. System error messages

System Message	Description
Alert! Previous attempts at booting this system have failed at checkpoint [nnnn]. For help in resolving this problem, please note this checkpoint and contact Dell Technical Support	The computer failed to complete the boot routine three consecutive times for the same error.
CMOS checksum error	RTC is reset, BIOS Setup default has been loaded.
CPU fan failure	CPU fan has failed
System fan failure	System fan has failed
Hard-disk drive failure	Possible hard disk drive failure during POST
Keyboard failure	Keyboard failure or loose cable. If reseating the cable does not solve the problem, replace the keyboard.
No boot device available	No bootable partition on hard disk drive, the hard disk drive cable is loose, or no bootable device exists. <ul style="list-style-type: none">• If the hard drive is your boot device, ensure that the cables are connected and that the drive is installed properly and partitioned as a boot device.• Enter system setup and ensure that the boot sequence information is correct.
No timer tick interrupt	A chip on the system board might be malfunctioning or motherboard failure.
NOTICE - Hard Drive SELF MONITORING SYSTEM has reported that a parameter has exceeded its normal operating range. Dell recommends that you back up your data regularly. A parameter out of range may or may not indicate a potential hard drive problem	S.M.A.R.T error, possible hard disk drive failure.

System Setup Overview

System Setup allows you to:

- change the system configuration information after you add, change, or remove any hardware in your computer.
- set or change a user-selectable option such as the user password.
- read the current amount of memory or set the type of hard drive installed.

Before you use System Setup, it is recommended that you write down the System Setup screen information for future reference.

 **CAUTION:** Unless you are an expert computer user, do not change the settings for this program. Certain changes can cause your computer to work incorrectly.

Accessing System Setup

1. Turn on (or restart) your computer.
2. After the white Dell logo appears, press <F2> or <F12> immediately.
The System Setup page displays.

 **NOTE:** If you wait too long and the operating system logo appears, continue to wait until you see the desktop. Then, shut down or restart your computer and try again.

System Setup Options

Table 4. — Main

System Time	Displays the system time. Allows you to reset the time on the computer's internal clock.
System Date	Displays the system date. Allows you to reset the date on the computer's internal calendar.
BIOS Version	Displays the BIOS revision.
Product Name	Displays the computer model number
Service Tag	Displays the service tag of your computer.
Asset Tag	Displays the asset tag of your computer (if available).
CPU Type	Displays the type of processor.
CPU Speed	Displays the speed of the processor
CPU ID	Displays the processor ID
CPU Cache	Displays the L1 and L2 cache size of the processor

SATA 0	Displays the model number and capacity of the hard drive.
SATA 1	Displays the model number and capacity of the hard drive.
AC Adapter Type	Displays the type of adapter.
System Memory	Displays the size of the memory installed.
Memory Speed	Displays the speed of the memory installed

Table 5. — Advanced

Intel (R) SpeedStep (TM)	Allows you to enable or disable the Intel SpeedStep technology. Default: Enabled
Virtualization	Allows you to enable or disable the virtualization feature. Default: Enabled
Integrated NIC	Allows you to enable to disable the integrated network Default: Enabled
SATA Operation	Allows you to change the SATA mode Default: AHCI
Adapter Warnings	Allows you to enable or disable the Adapter warnings Default: Enabled
Internal WLAN	Allows you to enable or disable the internal WLAN feature. Default: Enabled
Optical Device	Allows you to enable or disable boot option. Default: Disabled
USB Configuration	Allows you to enable or disable the USB ports. Front USB Ports: Enabled Rear USB Ports: Enabled USB debug: Enabled
Power Options	Allows you to modify the power options. Wake up by Integrated LAN/WLAN: Disabled AC Recovery: Power Off Deep Sleep Control: Enabled in S4 and S5 modes Auto Power On: Disabled

	Auto Power On Mode: Allows you to select the day (Default: disabled)
	Auto Power On Date: Allows you to select the date
	Auto Power On Time: Allows you to select the time
SMART Settings	Allows you to enable to enable or disable the SMART feature. Default: Disabled

Table 6. — Security

Unlock Setup Status	Allows you to lock or unlock the system setup. Default: Unlocked
Admin Password Status	Displays the status indicating if the Administrator password is set. Default: Not Set
System Password Status	Displays the status indicating if the System password is set. Default: Not Set
HDD Password Status	Displays the status indicating if the System password is set. Default: Not Set
Asset Tag	
Admin Password	
HDD Password	
Password Change	Allows you to set the option to change password. Default: Permitted
Password Bypass	Allows you to set the option to bypass the password. Default: Disabled
Secure Boot Mode	Allows you to enable to disable the Secure Boot Control. Default: Standard
HDD Protection	Allows you to modify the HDD protection feature. Default: Enabled

Table 7. — Boot

Boot List Option	Displays the boot modes Default: UEFI
------------------	--

	File Browser Add Boot Option and File Browser Del Boot Option are enabled
Secure Boot	Allows you to enable or disable the Secure Boot control. Default: Enabled
Legacy Option ROMs	Allows you to load the legacy option ROMs. Default: Disabled
Boot Option Priorities	Displays the boot option priorities. Boot Option # 1: Windows Boot Manager Boot Option # 2: Onboard NIC (IPV4) Boot Option #3: Onboard NIC (IPV6)

Table 8. — Exit

Save Changes and Reset	Allows you to save or rest the changes made to the system setup <ul style="list-style-type: none"> 1. Allows you to discard the changes made to the system setup 2. Allows you to restore the system setup options to default 3. Allows you to discard the changes made to the system setup 4. Allows you to save the changes made to the system setup
------------------------	--

Specifications

 **NOTE:** Offerings may vary by region. The following specifications are only those required by law to ship with your computer. For more information about the configuration of your computer, go to **Help and Support** in your Windows operating system and select the option to view information about your computer.

Table 9. — Processor

Type	<ul style="list-style-type: none"> • Intel Pentium • Intel Celeron
------	--

Table 10. — System Information

Chipset	Integrated on processor
---------	-------------------------

Table 11. — Memory

Memory module connector	one SoDIMM slot
Memory module capacity	2 GB, 4 GB, and 8 GB
Type	1600 MHz DDR3 (non-ECC)
Minimum memory	2 GB
Maximum memory	8 GB

Table 12. — Video

Type	
Controller	Intel HD graphics
Integrated video memory	shared system memory

Table 13. — Audio

Type	Integrated 5.1 high-definition audio
------	--------------------------------------

Table 14. — Network

Type	Realtek 10/100/1000 Mbps Ethernet
------	-----------------------------------

Table 15. — Expansion Bus

Bus speed	
SATA	6 Gbps for hard drive; 3 Gbps for optical drive

USB 2.0	480 Mbps
USB 3.0	5 Gbps

Table 16. — Drives

Externally accessible:

5.25-inch drive bays	one
----------------------	-----

Internally accessible:

3.5-inch/2.5 inch drive bays	one
------------------------------	-----

Table 17. — External Connectors

Audio

Back panel	three
------------	-------

Front Panel	one headset connector
-------------	-----------------------

Network	one RJ-45 connector
---------	---------------------

USB

Back panel	four USB 2.0 connectors
------------	-------------------------

Front Panel	two USB 3.0 connectors
-------------	------------------------

Video

- one 15-hole VGA connector
- one 19-pin HDMI connector

Table 18. — Control Lights And Diagnostic Lights

power button light	<ul style="list-style-type: none"> • white light — solid white light indicates power-on state. • blinking white light — solid white light indicates sleep state of the computer; steady / blinking amber light indicates a problem with the system board.
--------------------	---

drive activity light	white light — blinking white light indicates that the computer is reading data from, or writing data to the hard drive.
----------------------	---

Table 19. — Power

Coin-cell battery	3 V CR2032 lithium coin-cell
-------------------	------------------------------

Input voltage	100 VAC — 240 VAC
---------------	-------------------

Input frequency	50 Hz — 60 Hz
-----------------	---------------

Input current	1.7 A / 2.5 A
---------------	---------------

Output current	3.34 A / 4.62 A
----------------	-----------------

Maximum heat dissipation	
--------------------------	--



NOTE: Heat dissipation is calculated by using the power supply wattage rating.

Table 20. — Physical Dimensions of Chassis

Height	290 mm (11.42 inches)
Width	92.60 mm (3.65 inches)
Depth	293 mm (11.53 inches)
Weight (Minimum)	3.17 kg (6.99 pounds)

Table 21. — Environmental Specifications

Temperature	
Operating	10 °C to 35 °C (50 °F to 95 °F)
Storage	–40 °C to 65 °C (–40 °F to 149 °F)
Relative humidity	20 % to 80 % (non-condensing)
Altitude	
Operating	–15.20 m to 5000 m (–50 ft to 10,000 ft)
Storage	–15.20 m to 10668 m (–50 ft to 35,000 ft)
Airborne contaminant level	G1 as defined by ISA-S71.04–1985

Contacting Dell

 **NOTE:** If you do not have an active Internet connection, you can find contact information on your purchase invoice, packing slip, bill, or Dell product catalog.

Dell provides several online and telephone-based support and service options. Availability varies by country and product, and some services may not be available in your area. To contact Dell for sales, technical support, or customer service issues:

1. Go to **dell.com/support**.
2. Select your support category.
3. Verify your country or region in the **Choose a Country/Region** drop-down list at the bottom of the page.
4. Select the appropriate service or support link based on your need.

Free Manuals Download Website

<http://myh66.com>

<http://usermanuals.us>

<http://www.somanuals.com>

<http://www.4manuals.cc>

<http://www.manual-lib.com>

<http://www.404manual.com>

<http://www.luxmanual.com>

<http://aubethermostatmanual.com>

Golf course search by state

<http://golfingnear.com>

Email search by domain

<http://emailbydomain.com>

Auto manuals search

<http://auto.somanuals.com>

TV manuals search

<http://tv.somanuals.com>