

Dell S2422HZ/S2722DZ

Video Conferencing Monitor

User's Guide

Monitor Model: S2422HZ/S2722DZ
Regulatory Model: S2422HZt/S2722DZt





NOTE: A NOTE indicates important information that helps you make better use of your computer.



CAUTION: A CAUTION indicates potential damage to hardware or loss of data if instructions are not followed.



WARNING: A WARNING indicates a potential for property damage, personal injury, or death.

Copyright © 2021 Dell Inc. or its subsidiaries. All rights reserved. Dell, EMC, and other trademarks are trademarks of Dell Inc. or its subsidiaries. Other trademarks may be trademarks of their respective owners.

2021 – 08

Rev. A00

Contents

Safety instructions	5
About your monitor	6
Package contents	6
Product features	7
Identifying parts and controls	8
Front view	8
Back view	9
Bottom view	10
Monitor specifications	11
Resolution specifications	12
Preset display modes	13
Electrical specifications	15
Webcam specifications	16
Microphone specifications	16
Speaker specifications	16
Physical characteristics	16
Environmental characteristics	18
Pin assignments	19
Plug-and-Play	23
LCD monitor quality and pixel policy	23
Ergonomics	24
Handling and moving your display	25
Maintenance guidelines	27
Cleaning your monitor	27
Setting up the monitor	28
Connecting the stand	28
Using the tilt, swivel, and vertical extension	31



Tilt, swivel and vertical extension	31
Rotating the display	31
Configuring the display settings on your computer after rotation	32
Operating the monitor webcam	32
Connecting your monitor	33
Organizing your cables	35
Securing your monitor using Kensington lock (optional) . . .	35
Removing the monitor stand	36
Wall mounting (optional)	37
Operating the monitor	38
Power on the monitor	38
Using the front-panel controls	38
Using the OSD lock function	40
Front-panel buttons	43
Using the On-Screen Display (OSD) menu	44
Accessing the menu system	44
OSD warning messages	53
Setting the maximum resolution.	58
Setting up Windows Hello	59
Setting up the monitor webcam as default setting.	63
Setting up the monitor speaker as default setting	67
Troubleshooting	70
Self-test	70
Built-in diagnostics	71
Common problems.	72
Product specific problems	74
Universal Serial Bus (USB) specific problems	79
Appendix.	80
FCC notices (U.S. only) and other regulatory information. . .	80
Contacting Dell	80
EU product database for energy label and product information sheet	80



Safety instructions

⚠ WARNING: Use of controls, adjustments, or procedures other than those specified in this documentation may result in exposure to shock, electrical hazards, or mechanical hazards.

- Place the monitor on a solid surface and handle it carefully. The screen is fragile and can be damaged if dropped or pressed sharply.
- Ensure that your monitor is electrically rated to operate with the AC power available in your location.
- Keep the monitor in room temperature. Excessive cold or hot conditions can have an adverse effect on the liquid crystal of the display.
- Do not subject the monitor to severe vibration or high impact conditions. For example, do not place the monitor inside a car trunk.
- Unplug the monitor when it is going to be left unused for an extended period.
- To avoid electric shock, do not attempt to remove any cover or touch inside the monitor.

For information about safety instructions, see the Safety, Environmental, and Regulatory Information (SERI).









About your monitor

Package contents

Your monitor is shipped with components that are shown in the following table. If any component is missing, contact Dell. For more information, see [Contact Dell](#).

 **NOTE: Some components may be optional and may not ship with your monitor. Some features may not be available in certain countries.**

Component image	Component description
	Display
	Stand riser
	Stand base
	Power cable (varies by country)
	USB 3.2 Gen 1 Type-C cable (C to C)
	<ul style="list-style-type: none">• Quick Start Guide• Safety, Environmental, and Regulatory Information



Product features

The **Dell S2422HZ/S2722DZ** monitor has an active matrix, Thin-Film Transistor (TFT), Liquid Crystal Display (LCD), and LED backlight. The monitor features include:

- **S2422HZ:** 60.47 cm (23.8 in.) active area display (measured diagonally) 1920 x 1080 (16:9) resolution, plus full-screen support for lower resolutions.
- **S2722DZ:** 68.47 cm (27.0 in.) active area display (measured diagonally) 2560 x 1440 (16:9) resolution, plus full-screen support for lower resolutions.
- Tilt, swivel, pivot, and vertical extension adjustment capabilities.
- Speakers (2 x 5 W).
- Pedestal stand and Video Electronics Standards Association (VESA) 100 mm mounting holes for flexible mounting solutions.
- Ultra-thin bezel minimizes the bezel gap during multi-monitor usage, enabling easier setup with an elegant viewing experience.
- Extensive digital connectivity with DP helps future-proof your monitor.
- Single USB-C to supply power to compatible computer while receiving video signal.
- Camera can support 2560 x 1920 resolution.
- Plug and play capability if supported by your computer.
- On-Screen Display (OSD) adjustments for ease of set-up and screen optimization.
- Power and OSD buttons lock.
- Security lock slot.
- ≤ 0.3 W in Standby Mode.
- Premium Panel Exchange for peace of mind.
- Optimizes eye comfort with a flicker-free screen and minimizes hazard blue light emission.
- Uses Low Blue Light panel and is compliant with TUV Rheinland (Hardware Solution) at factory reset/default setting model.
- Decreases the level of hazard blue light that is emitted from the screen to make viewing more comfortable for your eyes.
- Adopts Flicker-Free technology, which clears the eye visible flicker, brings comfort viewing experience and prevents you suffering from eye strain and fatigue.
- Certified for Windows Hello (Face Authentication) and supports Microsoft Cortana.
- Supports AMD FreeSync technology. AMD Freesync certified range from 48 Hz - 75 Hz.

⚠ WARNING: The possible long-term effects of blue light emission from the monitor may cause damage to the eyes, including eye fatigue, or digital eye strain.



Identifying parts and controls

Front view

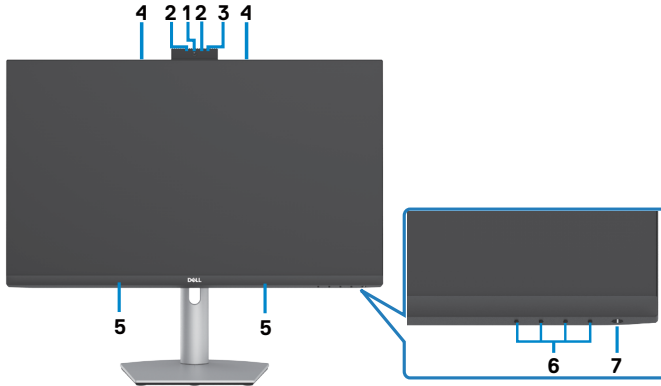

Label	Description	Use
1	RGB Webcam	With image sensor capable of operating at up to 30 fps in 10 bits 5M resolution with complete user control over image quality, formatting and output data transfer. Transmits your image in a video conference.
2	IR Webcam	Capture and Transmits image in dark light.
3	IR LED	Indicator of IR.
4	Microphone	Monitor microphones.
5	Built-in speakers	To output the sound from audio input.
6	Function buttons	For more information, see Operating the monitor.
7	Power on/off button (with LED indicator)	To turn the monitor on or off.



Back view



Label	Description	Use
1	VESA mounting holes (100 mm x 100 mm-behind attached VESA cover)	Wall mount monitor using VESA-compatible wall mount kit (100 mm x 100 mm).
2	Regulatory label	Lists the regulatory approvals.
3	Stand release button	Releases stand from the monitor.
4	Barcode, serial number, and Service Tag label	See this label if you have to contact Dell for technical support. The Service Tag is a unique alphanumeric identifier that enables Dell service technicians to identify the hardware components in your computer and access warranty information.
5	Cable-management slot	Use to organize cables by inserting them through the slot.



Bottom view

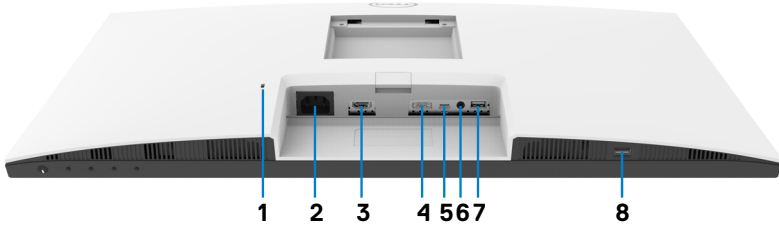

Label	Description	Use
1	Security lock slot	Secures the monitor with security cable lock (sold separately).
2	Power connector	Connect the power cable.
3	HDMI port	Connect your computer with the HDMI cable (optional).
4	DisplayPort in	Connect your computer with the DisplayPort cable (optional).
5	USB-C upstream/DisplayPort	Connect to your computer using the USB-C cable. The USB-C port offers the fastest transfer rate (USB 3.2 Gen 1). The alternate mode with DP 1.2 supports the following, and PD 20 V/3.25 A, 15 V/3 A, 9 V/3 A, 5 V/3 A. <ul style="list-style-type: none"> · S2422HZ maximum resolution of 1920 x 1080 at 75 Hz · S2722DZ maximum resolution of 2560 x 1440 at 75 Hz NOTE: USB-C is not supported on Windows versions that are prior to Windows 10.
6	Audio line-out port	Connect speakers to playback audio through HDMI or DisplayPort or USB-C audio channels. Only two-channel audio is supported. NOTE: The audio line-out port does not support headphones.
7	USB 3.2 downstream port	Connect the USB-C cable that comes with your monitor to the computer. Once this cable is connected, you can use the USB downstream connectors on your monitor. Port supports 0.9 A.
8	USB 3.2 downstream port	Connect the USB-C cable that comes with your monitor to the computer. Once this cable is connected, you can use the USB downstream connectors on your monitor. Port supports Battery Charging 2 A.



Monitor specifications

Model	S2422HZ	S2722DZ
Screen type	Active matrix - TFT LCD	
Panel type	In-plane switching technology	
Aspect ratio	16:9	
Viewable image dimensions:		
Diagonal	604.70 mm (23.80 in.)	684.70 mm (27.00 in.)
Active area:		
Horizontal	527.04 mm (20.75 in.)	596.74 mm (23.49 in.)
Vertical	296.46 mm (11.67 in.)	335.66 mm (13.22 in.)
Area	156246.28 mm ² (242.15 in. ²)	200301.75 mm ² (310.47 in. ²)
Pixel pitch	0.2745(H) mm x 0.2745 (V) mm	0.2331 (H) mm x 0.2331 (V) mm
Pixel per inch (PPI)	92.56	108.79
Viewing angle:		
Horizontal	178° (typical)	
Vertical	178° (typical)	
Brightness	250 cd/m ² (typical)	350 cd/m ² (typical)
Contrast ratio	1000 to 1 (typical)	
Display screen coating	Anti-glare treatment of the front polarizer (3H) hard coating	
Backlight	LED	
Response time (Gray to Gray)	8 ms (Normal mode) 5 ms (Fast mode) 4 ms (Extreme mode)	
Color depth	16.7 million colors (6 bit+FRC)	16.7 million colors (8 bit)
Color gamut ¹	99% sRGB with hardware low blue light	
Connectivity	<ul style="list-style-type: none"> • 1 x DP 1.2 (HDCP1.4) • 1 x HDMI1.4 (HDCP1.4) • 1 x USB-C (Alternate mode with DisplayPort 1.2, USB 3.2 Gen 1 upstream port, Power Delivery PD up to 65 W) • 1 x USB 3.2 Gen1 (5 Gbps) downstream with BC1.2 charging at 2A (maximum) • 1 x USB 3.2 downstream • 1 x 3.5 mm audio-out jack 	



Border width (edge of monitor to active area):		
Top	5.37 mm	7.37 mm
Left/Right	5.38 mm	7.43 mm
Bottom	21.74 mm	22.81 mm
Adjustability:		
Height adjustable stand	110 mm	
Tilt	-5° to 21°	
Swivel	-30° to 30°	
Pivot	-90° to 90°	
Cable management	Yes	
Dell Display Manager (DDM) compatibility	Easy Arrange and other key features	
Security	Security lock slot (cable lock sold separately)	

¹ At panel native only, under Custom Mode preset.

Resolution specifications

Model	S2422HZ	S2722DZ
Horizontal scan range	30 kHz to 90 kHz	30 kHz to 120 kHz
Vertical scan range	48 Hz to 75 Hz	
Maximum preset resolution	1920 x 1080 at 75 Hz	2560 x 1440 at 75 Hz
Video display capabilities (HDMI or DP or USB-C alternate mode)	480p, 560p, 720p, 1080p 480i, 576i, 1080i (HDMI only)	



Preset display modes

S2422HZ

Display mode	Horizontal frequency (kHz)	Vertical frequency (Hz)	Pixel clock (MHz)	Sync polarity (Horizontal/Vertical)
VESA, 640 x 480	31.47	59.94	25.18	-/-
VESA, 640 x 480	37.50	75.00	31.5	-/-
VESA, 720 x 400	31.47	70.08	28.32	-/+
VESA, 800 x 600	37.88	60.32	40.00	+/+
VESA, 800 x 600	46.88	75.00	49.50	+/+
VESA, 1024 x 768	48.36	60.00	65.00	-/-
VESA, 1024 x 768	60.02	75.03	78.75	+/+
VESA, 1152 x 864	67.50	75.00	108.00	+/+
VESA, 1280 x 1024	63.98	60.02	108.00	+/+
VESA, 1280 x 1024	79.98	75.02	135.00	+/+
VESA, 1600 x 900	55.54	59.98	97.75	+/+
VESA, 1920 x 1080	67.50	60.00	148.50	+/+
VESA, 1920 x 1080	83.89	74.97	174.50	-/+



S2722DZ

Display mode	Horizontal frequency (kHz)	Vertical frequency (Hz)	Pixel clock (MHz)	Sync polarity (Horizontal/Vertical)
VESA, 640 x 480	31.47	59.94	25.18	-/-
VESA, 640 x 480	37.50	75.00	31.50	-/-
VESA, 720 x 400	31.47	70.08	28.32	-/+
VESA, 800 x 600	37.88	60.32	40.00	+/+
VESA, 800 x 600	46.88	75.00	49.50	+/+
VESA, 1024 x 768	48.36	60.00	65.00	-/-
VESA, 1024 x 768	60.02	75.03	78.75	+/+
VESA, 1152 x 864	67.50	75.00	108.00	+/+
VESA, 1280 x 720	45.00	59.94	74.25	+/+
VESA, 1280 x 1024	63.98	60.02	108.00	+/+
VESA, 1280 x 1024	79.98	75.02	135.00	+/+
VESA, 1400 x 1050	65.32	59.98	121.75	-/+
VESA, 1600 x 900	60.00	60.00	108.00	+/+
VESA, 1600 x 1200	75.00	60.00	162.00	+/+
VESA, 1920 x 1080	67.50	60.00	148.50	+/+
VESA, 2560 x 1440	88.79	59.95	241.50	+/-
VESA, 2560 x 1440 (HDMI)	111.05	74.98	298.50	+/-
VESA, 2560 x 1440 (DP and USB-C)	111.86	74.97	304.25	+/-



Electrical specifications

Model	S2422HZ	S2722DZ
Video input signals	<ul style="list-style-type: none"> Digital video signal for each differential line Per differential line at 100 ohm impedance DP/HDMI/USB-C signal input support 	
Input voltage/ frequency/current	100-240 VAC/ 50 or 60 Hz \pm 3 Hz/2 A (maximum)	
Inrush current	120 V: 42 A (maximum) 240 V: 80 A (maximum) Cold start at 0°C	
Power Consumption	0.2 W (Off Mode) ¹ 0.2 W (Standby Mode) ¹ 13.5 W (On Mode) ¹ 137 W (Max) ² 12.62 W (P _{on}) ³ 41.03 kWh (TEC) ³	0.2 W (Off Mode) ¹ 0.3 W (Standby Mode) ¹ 24.0 W (On Mode) ¹ 149 W (Max) ² 18.26 W (P _{on}) ³ 58.09 kWh (TEC) ³

¹As defined in EU 2019/2021 and EU 2019/2013.

²Max brightness and contrast setting with maximum power loading on all USB ports.

³P_{on}: Power consumption of On Mode as defined in Energy Star 8.0 version.

TEC: Total energy consumption in kWh as defined in Energy star 8.0 version.

This document is informational only and reflects laboratory performance. Your product may perform differently, depending on the software, components, and peripherals you ordered and shall have no obligation to update such information. Accordingly, the customer should not rely upon this information in making decisions about electrical tolerances or otherwise. No warranty as to accuracy or completeness is expressed or implied.

 **NOTE:** This monitor is ENERGY STAR certified.



This product qualifies for ENERGY STAR in the factory default settings which can be restored by “Factory Reset” function in the OSD menu. Changing the factory default settings or enabling other features may increase power consumption that could exceed the ENERGY STAR specified limit.



Webcam specifications

Lens	Field of view (horizontal)	75.4° for 2560 x 1920
	Focus mode	Fixed focus
	Focus area	35 cm~1.5 m
	Focusing distance (normal mode)	70 cm
Image sensor	Active array size	5 mega-pixel
Video specification	Video frame rate	1920 x 1080 (Full HD)- up to 30 frames per second
Interface	USB 2.0 High Speed	
Power supply	3.3 volts +/- 5% for USB 5 volts +/- 5% for IR camera	

Microphone specifications

Model	S2422HZ	S2722DZ
Microphone type	Knowles digital microphone x 2	
Sensitivity	-35dB +/- 1dB	
Signal to noise ratio	68 dB	
Total harmonic distortion	0.3%	
Acoustic overload point	130 dB SPL	
Power supply	1.65 V - 3.6 V	

Speaker specifications

Model	S2422HZ	S2722DZ
Speaker rated power	2 x 5 W	
Frequency response	200 Hz - 16 kHz	
Impedance	8 ohm	

Physical characteristics

Model	S2422HZ	S2722DZ
Connector type	<ul style="list-style-type: none"> • DP connector • HDMI connector • USB 3.2 Gen 1 upstream connector • Audio line-out • USB downstream connector x 2 	



Signal cable type	USB 3.2 Gen 1 Type-C to C 1.8 M cable	
Dimensions (with stand):		
Height (extended)	488.40 mm (19.23 in.)	510.00 mm (20.08 in.)
Height (compressed)	378.40 mm (14.90 in.)	400.00 mm (15.75 in.)
Width	537.80 mm (21.17 in.)	611.60 mm (24.08 in.)
Depth	174.70 mm (6.88 in.)	174.70 mm (6.88 in.)
Dimensions (without stand):		
Height	323.57 mm (12.74 in.)	365.84 mm (14.40 in.)
Width	537.80 mm (21.17 in.)	611.60 mm (24.08 in.)
Depth	56.74 mm (2.23 in.)	56.74 mm (2.23 in.)
Stand dimensions:		
Height (extended)	403.10 mm (15.87 in.)	403.10 mm (15.87 in.)
Height (compressed)	364.82 mm (14.36 in.)	364.82mm (14.36 in.)
Width	257.00 mm (10.12 in.)	257.00 mm (10.12 in.)
Depth	174.70 mm (6.88 in.)	174.70 mm (6.88 in.)
Weight:		
Weight with packaging	7.88 kg (17.37 lb)	9.46kg (20.85 lb)
Weight with stand assembly and cables	5.60 kg (11.82 lb)	6.86 kg (15.12 lb)
Weight without stand assembly (For wall mount or VESA mount considerations - no cables)	3.88 kg (8.55 lb)	5.18 kg (11.42 lb)
Weight of stand assembly	1.52 kg (3.35 lb)	1.52 kg (3.35 lb)



Environmental characteristics

Compliant standards	
<ul style="list-style-type: none"> ENERGY STAR certified monitor. RoHS compliant. BFR/PVC Reduce monitor (The circuit boards are made from BFR/PVC-free laminates). Arsenic-Free glass and Mercury-Free for the panel only. 	
Temperature:	
Operating	0°C to 40°C (32°F to 104°F)
Non-operating	-20°C to 60°C (-4°F to 140°F)
Humidity:	
Operating	10% to 80% (non-condensing)
Non-operating	5% to 90% (non-condensing)
Altitude:	
Operating	5,000 m (16,404 ft) (maximum)
Non-operating	12,192 m (40,000 ft) (maximum)
Thermal dissipation:	
S2422HZ	467.77 BTU/hour (maximum) 43.09 BTU/hour (on mode)
S2722DZ	508.75 BTU/hour (maximum) 62.35 BTU/hour (on mode)



Pin assignments

DP port (in)

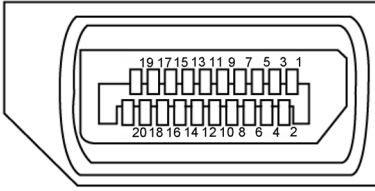

Pin number	20-pin side of the connected signal cable
1	ML3(n)
2	GND
3	ML3(p)
4	ML2(n)
5	GND
6	ML2(p)
7	ML1(n)
8	GND
9	ML1(p)
10	ML0(n)
11	GND
12	ML0(p)
13	CONFIG1
14	CONFIG2
15	AUX CH (p)
16	GND
17	AUX CH (n)
18	Hot Plug Detect
19	Return
20	DP_PWR



HDMI port

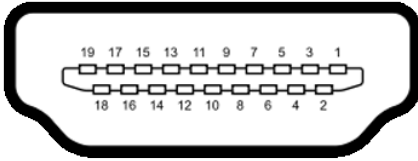

Pin number	19-pin side of the connected signal cable
1	TMDS DATA 2+
2	TMDS DATA 2 SHIELD
3	TMDS DATA 2-
4	TMDS DATA 1+
5	TMDS DATA 1 SHIELD
6	TMDS DATA 1-
7	TMDS DATA 0+
8	TMDS DATA 0 SHIELD
9	TMDS DATA 0-
10	TMDS CLOCK+
11	TMDS CLOCK SHIELD
12	TMDS CLOCK-
13	CEC
14	Reserved (N.C. on device)
15	DDC CLOCK (SCL)
16	DDC DATA (SDA)
17	DDC/CEC Ground
18	+5 V POWER
19	HOT PLUG DETECT



USB-C port

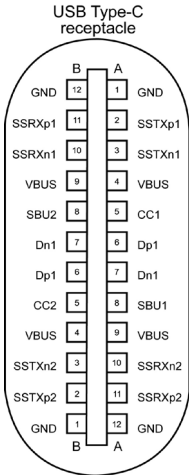



typically connected to a charger through a Type-C cable

Pin	Signal	Pin	Signal
A1	GND	B12	GND
A2	SSTXp1	B11	SSRXp1
A3	SSTXn1	B10	SSRXn1
A4	VBUS	B9	VBUS
A5	CC1	B8	SBU2
A6	Dp1	B7	Dn1
A7	Dn1	B6	Dp1
A8	SBU1	B5	CC2
A9	VBUS	B4	VBUS
A10	SSRXn2	B3	SSTXn2
A11	SSRXp2	B2	SSTXp2
A12	GND	B1	GND



Universal Serial Bus (USB)

This section provides information about the USB ports available on your monitor.

 **NOTE:** Up to 2 A on USB downstream port (port with  battery icon) with BC 1.2 compliance devices; up to 0.9 A on the other 1 USB downstream ports.

Your computer has the following USB ports:

- 1 upstream - at rear.
- 2 downstream - 1 at bottom, 1 at rear.

 **NOTE:** The monitor's USB ports work only when the monitor is on or when the monitor is on, in Standby Mode. When the monitor is on, in Standby Mode, if the USB cable (C to C), is plugged in, the USB ports can work normally. Otherwise, follow the OSD setting of Other USB Charging, if the setting is "On in Standby Mode" then USB work normally, otherwise USB is disabled. If you turn off the monitor and then turn it on, the attached peripherals may take a few seconds to resume normal functionality.

Transfer speed	Data rate	Maximum power consumption (each port)
super speed	5 Gbps	4.5 W
hi speed	480 Mbps	2.5 W
full speed	12 Mbps	2.5 W

USB downstream port



Pin number	Signal name
1	VBUS
2	D-
3	D+
4	GND
5	StdA_SSRX-
6	StdA_SSRX+
7	GND_DRAIN
8	StdA_SSTX-
9	StdA_SSTX+
Shell	Shield



Plug-and-Play

You can install the monitor in any Plug-and-Play-compatible computer. The monitor automatically provides the computer with its extended display identification data (EDID) using display data channel (DDC) protocols so that the computer can configure itself and optimize the monitor settings. Most monitor installations are automatic; you can select different settings, if necessary. For more information about changing the monitor settings, see [Operating the monitor](#).

LCD monitor quality and pixel policy

During the LCD monitor manufacturing process, it is normal for one or more pixels to become fixed in an unchanging state, which are hard to see and do not affect the display quality or usability. For more information about LCD Monitor Pixel Policy, see Dell support site at <https://www.dell.com/pixelguidelines>.



Ergonomics

△ CAUTION: Improper or prolonged usage of keyboard may result in injury.

△ CAUTION: Viewing the monitor screen for extended periods of time may result in eye strain.

For comfort and efficiency, observe the following guidelines when setting up and using your computer workstation:

- Position your computer so that the monitor and keyboard are directly in front of you as you work. Special shelves are commercially available to help you correctly position your keyboard.
- To reduce the risk of eye strain and neck, arm, back, or shoulder pain from using the monitor for long periods of time, it is recommended to:
 - Set the distance of the screen between 20 in. to 28 in. (50 cm - 70 cm) from your eyes.
 - Blink frequently to moisten your eyes or wet your eyes with water after prolonged usage of the monitor.
 - Take regular and frequent breaks for 20 minutes every two hours.
 - Look away from your monitor and gaze at a distant object at 20 ft away for at least 20 seconds during the breaks.
 - Perform stretches to relieve tension in the neck, arm, back, and shoulders during the breaks.
- Ensure that the monitor screen is at eye level or slightly lower when you are sitting in front of the monitor.
- Adjust the tilt of the monitor, its contrast, and brightness settings.
- Adjust the ambient lighting around you (such as overhead lights, desk lamps, and the curtains or blinds on nearby windows) to minimize reflections and glare on the monitor screen.
- Use a chair that provides good lower-back support.
- Keep your forearms horizontal with your wrists in a neutral, comfortable position while using the keyboard or mouse.
- Always leave space to rest your hands while using the keyboard or mouse.
- Let your upper arms rest naturally on both sides.
- Ensure that your feet are resting flat on the floor.
- When sitting, ensure that the weight of your legs is on your feet and not on the front portion of your seat. Adjust your chair height or use a footrest if necessary to maintain a proper posture.
- Vary your work activities. Try to organize your work so that you do not have to sit and work for extended periods of time. Try to stand or get up and walk around at regular intervals.



- Keep the area under your desk clear of obstructions and cables or power cords that may interfere with comfortable seating or present a potential trip hazard.

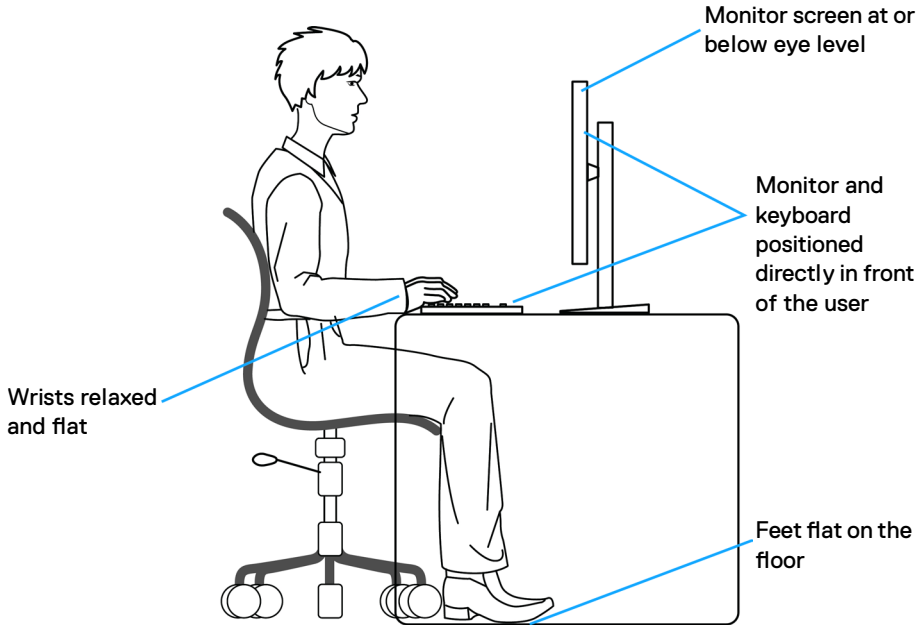

Handling and moving your display

To ensure that the monitor is handled safely when lifting or moving it, observe the following guidelines:

- Before moving or lifting the monitor, turn off your computer and monitor.
- Disconnect all cables from the monitor.
- Place the monitor in the original box with the original packing materials.
- Hold the bottom edge and the side of the monitor firmly without applying excessive pressure when lifting or moving the monitor.



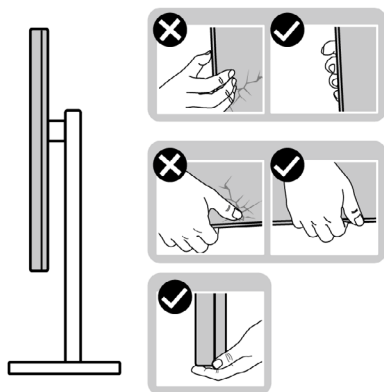

- When lifting or moving the monitor, ensure that the screen is facing away from you. Do not press on the display area to avoid any scratches or damage.

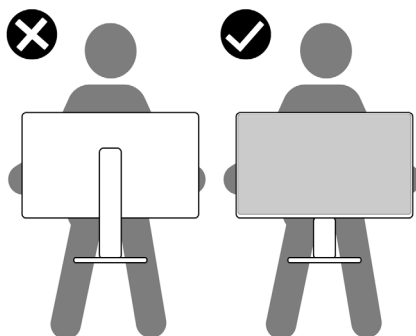

- When transporting the monitor, avoid any sudden shock or vibration to it.
- When lifting or moving the monitor, do not turn the monitor upside down while holding the stand base or stand riser. It may result in accidental damage to the monitor or cause personal injury.

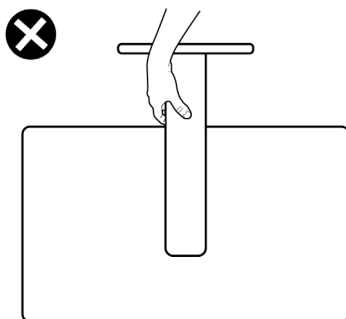

Maintenance guidelines

Cleaning your monitor

 **WARNING:** Before cleaning the monitor, unplug the monitor power cable from the electrical outlet.

 **CAUTION:** Read and follow the [Safety instructions](#) before cleaning the monitor.



For best practices, follow these instructions while unpacking, cleaning, or handling your monitor:

- To clean your anti-static screen, lightly dampen a soft, clean cloth with water. If possible, use a special screen-cleaning tissue or solution suitable for the anti-static coating. Do not use benzene, thinner, ammonia, abrasive cleaners, or compressed air.
- Use a lightly dampened, soft cloth to clean the monitor. Avoid using detergent of any kind as some detergents leave a milky film on the monitor.
- If you notice white powder when you unpack your monitor, wipe it off with a cloth.
- Handle your monitor with care as a dark-colored monitor may get scratched and show white scuff marks more than a light-colored monitor.
- To help maintain the best image quality on your monitor, use a dynamically changing screen saver and turn off your monitor when not in use.



Setting up the monitor

Connecting the stand

-  **NOTE:** The stand riser and stand base are detached when the monitor is shipped from the factory.
-  **NOTE:** The following instructions are applicable only for the stand that is shipped with your monitor. If you are connecting a stand that you purchased from any other source, follow the setup instructions that were included with the stand.

To attach the monitor stand:

1. Align and place the stand riser on the stand base.
2. Open the screw handle at the bottom of the stand base and turn it clockwise to secure the stand assembly.
3. Close the screw handle.

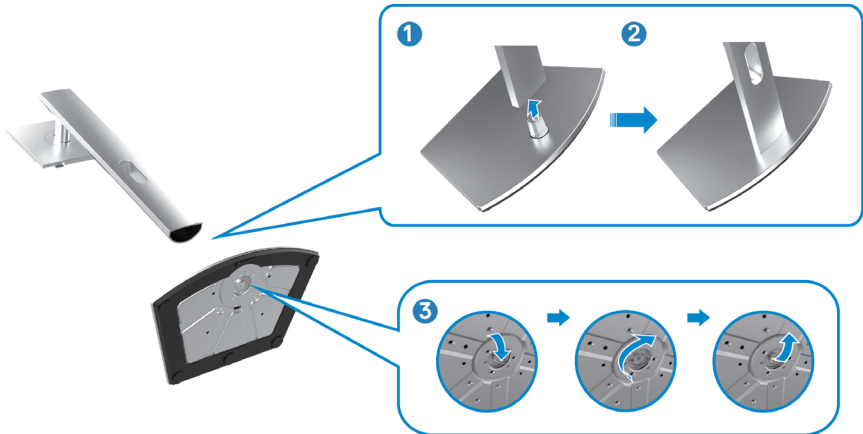

4. Open the protective cover on the monitor to access the VESA slot on the monitor.



5. Slide the tabs on the stand riser into the slots on the display back cover and lower the stand assembly to snap it into place.



6. Hold the stand riser and lift the monitor carefully, then place it on a flat surface.



NOTE: Hold the stand riser firmly when lifting the monitor to avoid any accidental damage.

7. Lift the protective cover from the monitor.

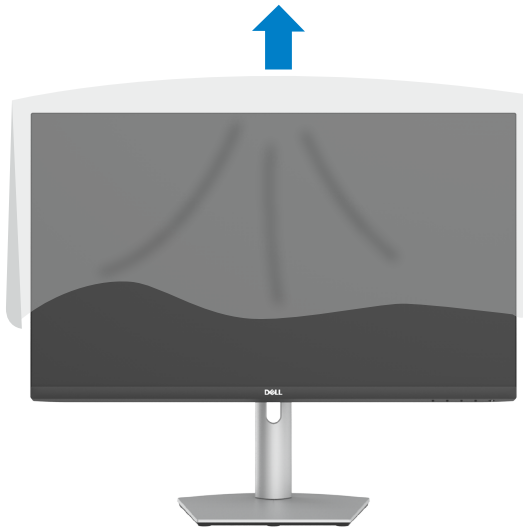

Using the tilt, swivel, and vertical extension

NOTE: The following instructions are applicable only for the stand that is shipped with your monitor. If you are connecting a stand that you purchased from any other source, follow the setup instructions that were included with the stand.

Tilt, swivel and vertical extension

With the stand that is attached to the monitor, you can tilt the monitor for the most comfortable viewing angle.

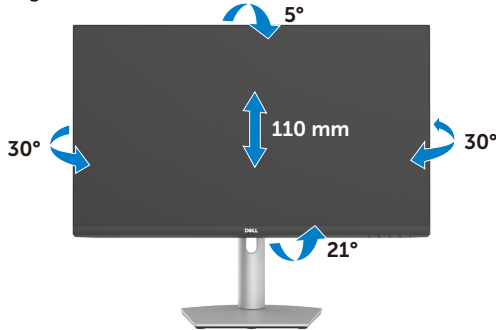

NOTE: The stand is detached when the monitor is shipped from the factory.

Rotating the display

Before you rotate the display, extend the display vertically until the top of the stand riser. Tilt the display backwards until the maximum to avoid pressing the bottom edge of the display.



NOTE: To toggle the display setting on your Dell computer between landscape and portrait when rotating the display, download and install the latest graphics driver. To download, go to <https://www.dell.com/support/drivers> and search for the appropriate driver.

NOTE: When the display is in portrait mode, you may experience performance degradation when using graphic-intensive applications such as 3D gaming.



Configuring the display settings on your computer after rotation

After rotating the display, complete the following procedure to configure the display settings on your computer.

 **NOTE:** If you are using the monitor with a non-Dell computer, go to the graphics card manufacturer's website or your computer manufacturer website for information about rotating the contents of your display.

To configure the display settings:

1. Right-click the **Desktop** and click **Properties**.
2. Select the **Settings** tab and click **Advanced**.
3. If you have an AMD graphics card, select the **Rotation** tab and set the preferred rotation.
4. If you have an **nVidia** graphics card, click the **nVidia** tab, in the left column select **NVRotate**, and then select the preferred rotation.
5. If you have an Intel graphics card, select the Intel graphics tab, click **Graphic Properties**, select the **Rotation** tab, and then set the preferred rotation.

 **NOTE:** If you do not see the rotation option or it is not working correctly, go to <https://www.dell.com/support> and download the latest driver for your graphics card.

Operating the monitor webcam

Follow these steps when you want to use the monitor webcam:

1. Peel off the camera label on monitor.
2. Push the top of the webcam to extend or retract the camera.
3. Peel off the protective film on webcam.
4. Extend the camera before use and retract the camera to protect your privacy when not in use.

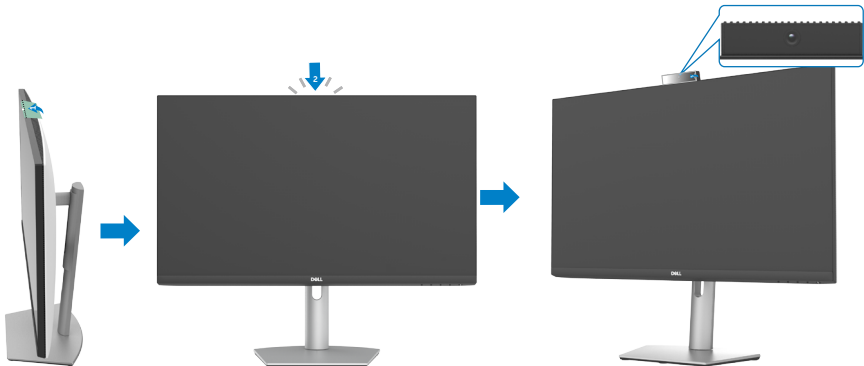

Connecting your monitor

⚠ WARNING: Before you begin working on the following steps follow the [Safety instructions](#).

To connect your monitor to the computer:

1. Turn off your computer.
2. Connect the HDMI, or DisplayPort, and the USB-C cable from your monitor to the computer.
3. Turn on your monitor.
4. Select the correct input source from the OSD Menu on your monitor and then turn on your computer.

📌 NOTE: S2422HZ/S2722DZ default setting is DisplayPort 1.2. A DisplayPort 1.1 Graphic card may not display normally.

Connecting the HDMI cable (optional purchase)

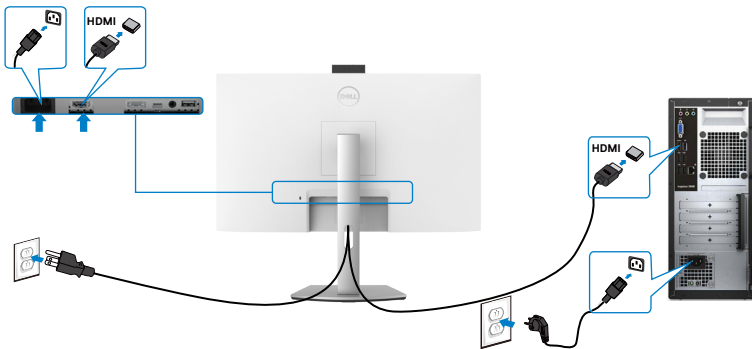

Connecting the DP cable (optional purchase)

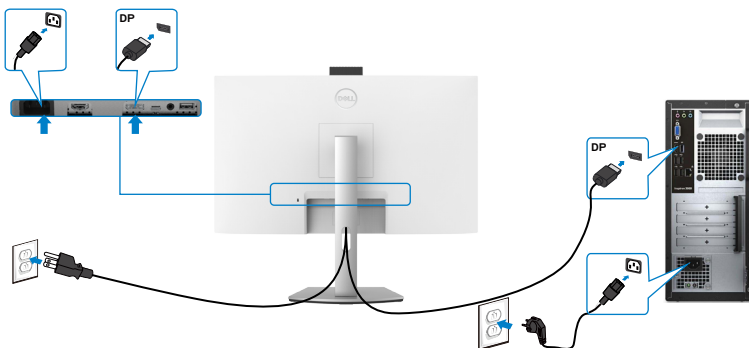

Connecting the USB-C cable

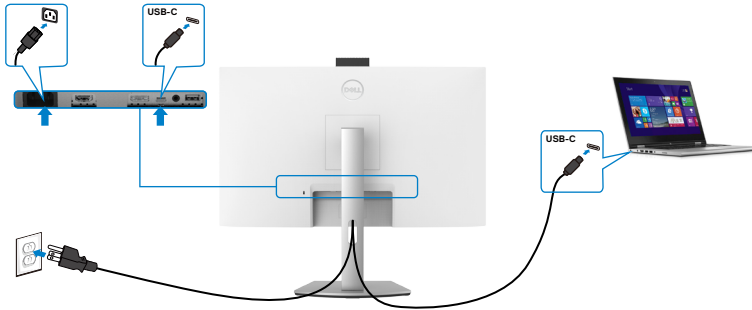

The USB-C port on your monitor:

- Can be used as USB-C or DisplayPort 1.2, alternatively.
- Supports USB Power Delivery (PD), with profiles up to 65 W.

NOTE: Regardless of the power requirement/actual power consumption of your laptop, or the remaining power runtime in your battery, the Dell monitor is designed to supply power delivery of up to 65 W to your laptop.

Rated power (on laptops that have USB-C with Power Delivery)	Maximum charging power
45 W	45 W
65 W	65 W
90 W	Not supported



Organizing your cables



After attaching all necessary cables to your monitor and computer, organize all cables as shown in the image. See [Connecting your monitor](#) for more information about cable connections.

Securing your monitor using Kensington lock (optional)

The security lock slot is at the bottom of the monitor. For more information about the location of the security lock slot, see [Security lock slot](#).

For more information about using the Kensington lock (purchased separately), see the documentation that is shipped with the lock.

Secure your monitor to a table using the Kensington security lock.

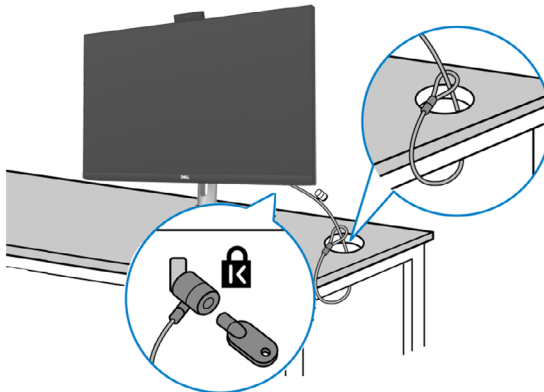

NOTE: The image is for illustration purpose only. Appearance of the lock may vary.



Removing the monitor stand

CAUTION: To prevent scratches on the LCD screen when removing the stand, ensure that the monitor is placed on a soft and clean surface.

NOTE: The following instructions are applicable only for the stand that is shipped with your monitor. If you are connecting a stand that you purchased from any other source, follow the setup instructions that were included with the stand.

To remove the stand:

1. Place the monitor on a soft cloth or cushion.
2. Press and hold the stand-release button.
3. Lift the stand up and away from the monitor.

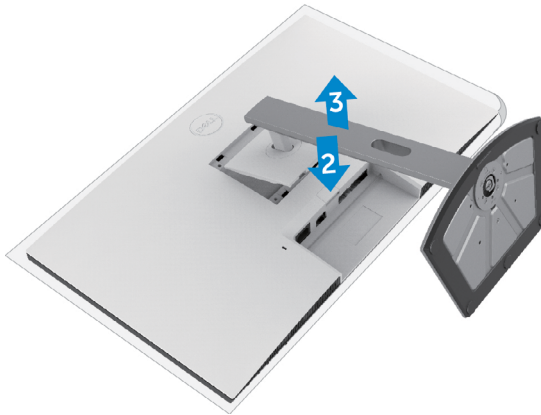

Wall mounting (optional)



NOTE: Use M4 x 11 mm screws to connect the monitor to the wall-mounting kit.

Follow the instructions that come with the VESA-compatible wall mounting kit.

1. Place the monitor on a soft cloth or cushion on a stable flat table.
2. Remove the stand.
3. Use a Phillips crosshead screwdriver to remove the four screws securing the plastic cover.
4. Attach the mounting bracket from the wall mounting kit to the monitor.
5. Mount the monitor on the wall as instructed in the documentation that shipped with the wall-mounting kit.

NOTE: For use only with UL or CSA or GS-listed wall mount bracket with minimum weight or load bearing capacity.

- S2422HZ: 15.52 kg (34.20 lb)
- S2722DZ: 20.72 kg (45.68 lb)



Operating the monitor

Power on the monitor

Press the  button to turn on the monitor.

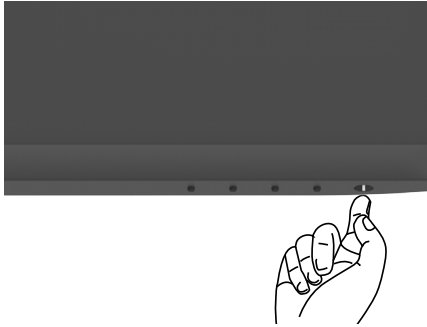



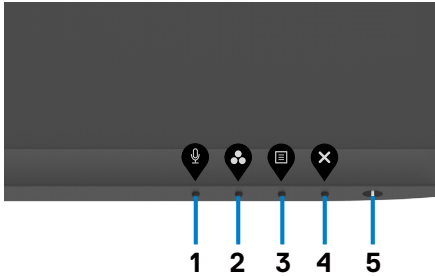

Using the front-panel controls

Use the control buttons at the bottom edge of the monitor to adjust the specifications of the image being displayed. When using the control buttons, an On-Screen Display (OSD) menu appears on the screen with numeric values.



The following table describes the front panel buttons:

Front-panel button	Description
1  Shortcut key: Microphone	Use this button to choose to unmute or mute the microphone. NOTE: Mute function on the Dell S2422HZ or S2722DZ works by pressing the Mute button, but the Mute icon on the UC platform is not sync (Icon shows unmute).
2  Shortcut key: Preset Modes	Use this button to choose from a list of preset color modes.
3  Menu	Use this menu button to launch the on-screen display (OSD) and select the OSD menu. See Accessing the menu system .
4  Exit	Use this button to go back to the main menu or exit the OSD main menu.
5  Power button (with power-status light)	Turn the monitor on or off. Solid white light indicates that the monitor is turned on and functioning normally. Blinking white light indicates that the monitor is in Standby Mode.



Using the OSD lock function

You can lock the front-panel control buttons to prevent access to the OSD menu and/or power button.

Using the Lock menu to lock one or more buttons

1. Select one of the following options.

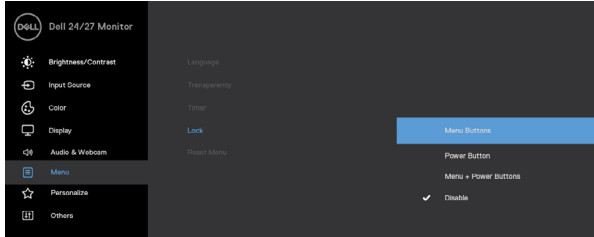

The following message appears.

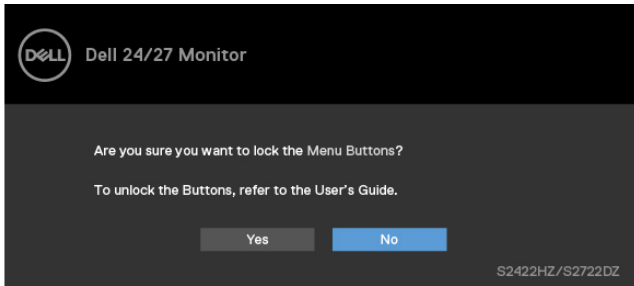

2. Select **Yes** to lock the buttons. Once locked, pressing any control button will display the lock icon  .





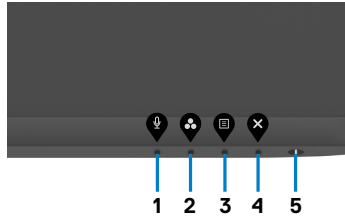

Using the front-panel control button to lock one or more buttons

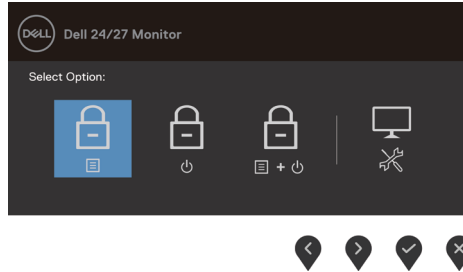

1. Press and hold **Button 4** for four seconds, a menu appears on the screen.



2. Select one of the following options:





Options	Description
1  Menu button lock	Select this option to lock OSD menu function.
2  Power button lock	Use this option to lock the power button. It prevents you to turn off the monitor using the power button.
3  Menu and Power button lock	Use this option to lock OSD menu and power button to turn off the monitor.
4  Built-in diagnostics	Use this option to run the built-in diagnostics. See Built-in diagnostics .

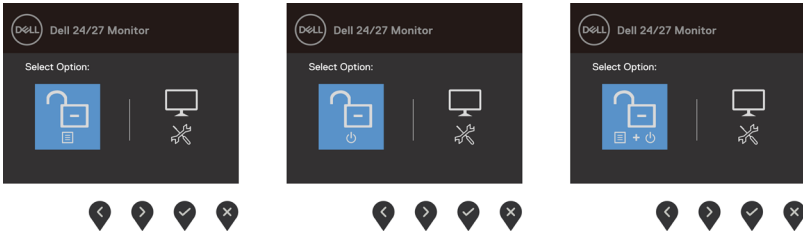

Unlocking the front-panel control buttons

Press and hold **Button 4** for four seconds until a menu appears on the screen. The following table describes the options to unlock the front-panel control buttons.







Options	Description
1  Menu button unlock	Use this option to unlock OSD menu function.
2  Power button unlock	Use this option to unlock power button to turn off the monitor.
3  Menu and power button unlock	Use this option to unlock OSD menu and power button to turn off the monitor.
4  Built-in diagnostics	Use this option to run the built-in diagnostics. See Built-in diagnostics .

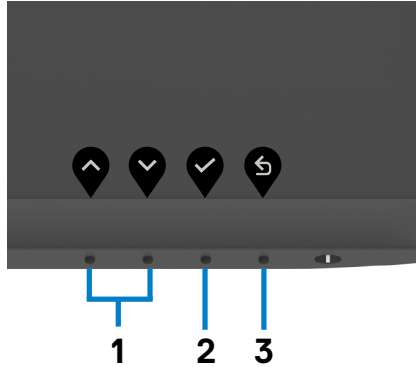

Front-panel buttons

Use the buttons at the front of the monitor to adjust the image settings.









Front-panel button	Description
1  Up  Down	Use the Up (increase) and Down (decrease) buttons to adjust items in the OSD menu.
2  OK	Use the OK button to confirm your selection.
3  Back	Use the Back button to go back to the previous menu.

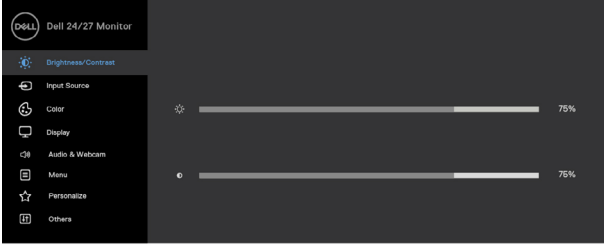





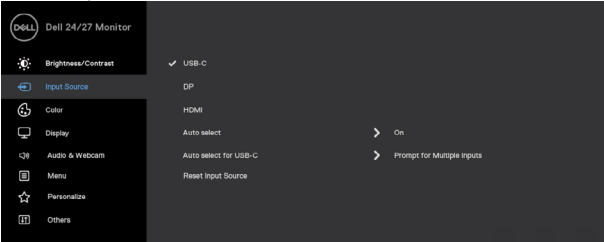

Using the On-Screen Display (OSD) menu

Accessing the menu system

Icon	Menu and submenus	Description
	Brightness/Contrast	Use this menu to activate brightness and contrast adjustment.
		
		
Brightness	Brightness adjusts the luminance of the backlight (minimum 0; maximum 100). Press the  button to increase brightness. Press the  button to decrease brightness.	
Contrast	Adjust the Brightness first, and then adjust Contrast only if further adjustment is necessary. Press the  button to increase contrast and press the  button to decrease contrast. Adjust the contrast between 0 – 100. Contrast adjusts the difference between darkness and lightness on the monitor.	



Icon	Menu and submenus	Description
	Input Source	Use the Input Source menu to select between different video inputs that are connected to your monitor.
		
		
USB-C	Use  to select the USB-C input source.	
DP	Use  to select the DP input source.	
HDMI	Use  to select the HDMI input source.	
Auto select	Use  to select Auto select to scan for available input signals.	
Auto select for USB-C	<p>Allows you to set Auto select for USB-C to:</p> <ul style="list-style-type: none"> · Prompt for Multiple Inputs: Always shows Switch to USB-C Video Input message for you to choose whether to switch or not. · Yes: The monitor always switches to USB-C video without asking while USB-C connected. · No: The monitor will NOT auto switch to USB-C video from another available input. 	
Reset Input Source	Resets all settings under the Input Source menu to the factory defaults.	



Icon	Menu and submenus	Description
------	-------------------	-------------



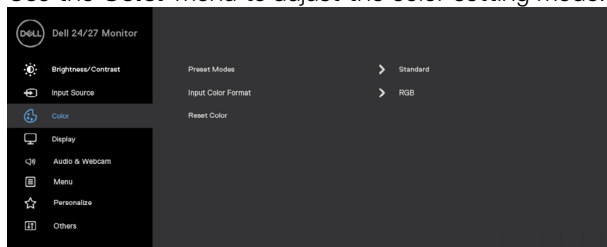

Color

Use the **Color** menu to adjust the color setting mode.

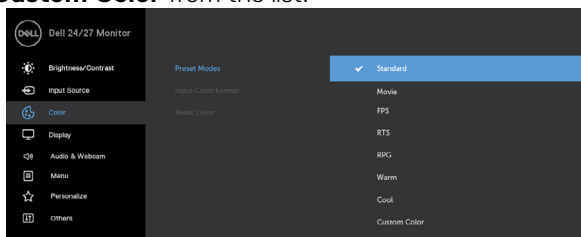

Preset Modes When you select **Preset Modes**, you can choose **Standard, Movie, FPS, RTS, RPG, Warm, Cool, or Custom Color** from the list.



- **Standard:** Default color settings. This mode is the default preset mode.
- **Movie:** Loads color settings ideal for movies.
- **FPS:** Loads color settings ideal for First-Person Shooter games.
- **RTS:** Loads color settings ideal for Real-Time Strategy games.
- **RPG:** Loads color settings ideal for Role-Playing games.
- **Warm:** Increases the color temperature. The screen appears warmer with a red or yellow tint.
- **Cool:** Decreases the color temperature. The screen appears cooler with a blue tint.
- **Custom Color:** Allows you to manually adjust the color settings. Press the  and  buttons to adjust the Red, Green, and Blue values and create your own preset color mode.



Icon	Menu and submenus	Description
------	-------------------	-------------



Input Color Format

Allows you to set the video input mode to:

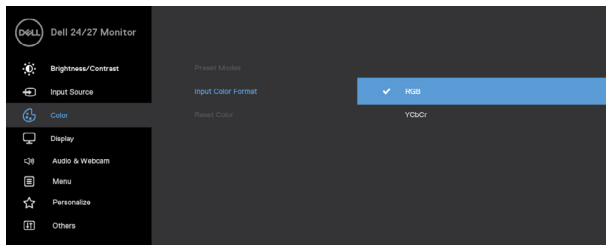
- ◆ **RGB:** Select this option if your monitor is connected to a computer (or DVD player) using the USB-C, DP, HDMI cable.
- ◆ **YCbCr:** Select this option if your DVD player supports only YCbCr output.





Hue

Use  or  to adjust the hue from 0 to 100.

NOTE: Hue adjustment is available only for Movie and FPS, RTS, RPG mode.

Saturation

Use  or  to adjust the saturation from 0 to 100.

NOTE: Saturation adjustment is available only for Movie and FPS, RTS, RPG mode.

Reset Color

Resets your monitor's color settings to the factory defaults.



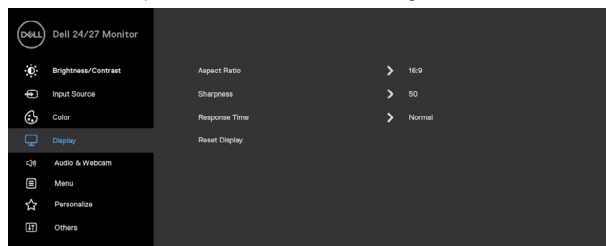

Display

Use the Display menu to adjust image.



Aspect Ratio Adjust the image ratio to **16:9, 4:3, 5:4**.



Icon	Menu and submenus	Description
	Sharpness	Makes the image look sharper or softer. Use  or  to adjust the sharpness from '0' to '100'.
	Response Time	Allows you to set the Response Time to Normal or Fast or Extreme .
	Reset Display	Resets all settings under the Display menu to the factory defaults.





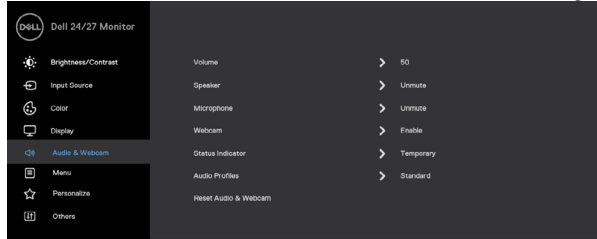

Audio & Webcam

Use the Audio & Webcam menu to adjust the settings.

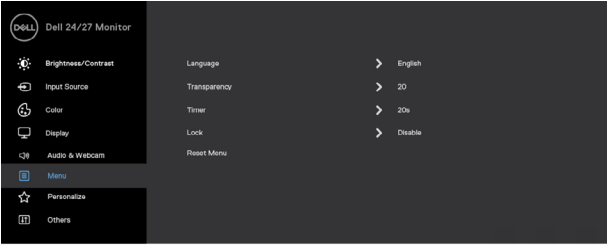

Volume	Allows you to increase the speaker volume. Press the  and  buttons to adjust the volume from '0' to '100'.
Speaker	Select Mute or Unmute the Speaker function.
Microphone	Select Mute or Unmute the Microphone function.
Webcam	Select Enable or Disable the Webcam function.
Status Indicator	Select Off or Temporary to show the status of speaker, microphone, and webcam.
Audio Profile	Select playback function.
Reset Audio & Webcam	Resets all settings under the Audio & Webcam menu to the factory defaults. NOTE: With the USB cable audio volume sync with windows volume and not to default settings. NOTE: If the user connects the HDMI cable to play audio and then plug in the USB-C cable, the audio channel moves to echo canceling. Monitor Volume also sync with computer.



Icon	Menu and submenus	Description
	Menu	<p>Select this option to adjust the OSD settings, such as the OSD languages, the amount of time the menu remains on screen, and so on.</p> 
	Language	<p>Set the OSD display to one of eight languages. (English, Spanish, French, German, Brazilian Portuguese, Russian, Simplified Chinese, or Japanese).</p>
	Transparency	<p>Select this option to change the menu transparency by using  and  (min. 0/max. 100).</p>
	Timer	<p>OSD Hold Time: Sets the length of time the OSD remains active after you press a button. Use the  and  buttons to adjust the slider in 1-second increments, from 5 to 60 seconds.</p>



Icon	Menu and submenus	Description
------	-------------------	-------------

Lock

With the control buttons on the monitor locked, you can prevent people from accessing the controls. It also prevents accidental activation in multiple monitors side-by-side setup.

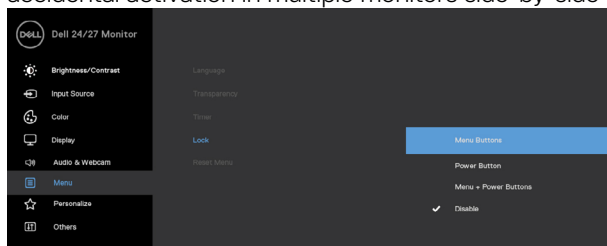

- **Menu Buttons:** Through OSD to lock the Menu buttons.
- **Power Button:** Through OSD to lock the Power button.
- **Menu + Power Buttons:** Through OSD to lock all Menu and Power buttons.
- **Disable:** Press and hold the  button next to the power button for four seconds to unlock the buttons.

Reset Menu

Resets all settings under the **Reset menu** to the factory defaults.

Personalize

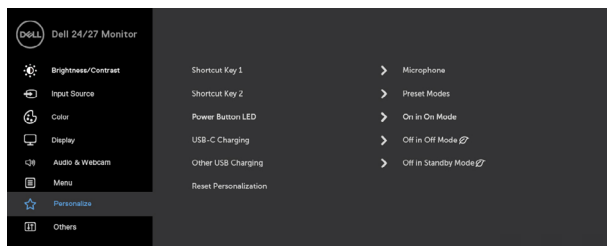

Shortcut key 1

Select from **Preset Modes, Brightness/Contrast, Input Source, Aspect Ratio, Volume, Speaker, Microphone, Webcam** set as shortcut key.

Shortcut key 2

Power Button LED

Allows you to set the state of the power light to save energy.



Icon	Menu and submenus	Description
	USB-C Charging	Allows you to enable or disable USB-C Charging charging function during monitor power off mode.
	Other USB Charging	Allows you to enable or disable Other USB Charging function during monitor Standby mode.
	Reset Personalization	Resets all settings under the Personalize menu to the factory preset values.



Others

Select this option to adjust the OSD settings such as the **DDC/CI, LCD conditioning**, and so on.

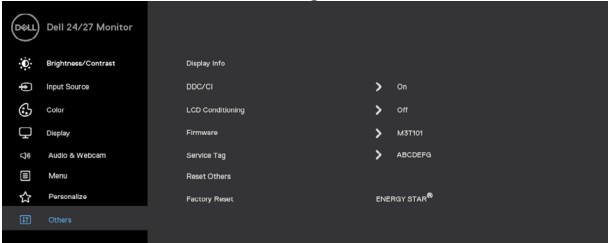



Display Info

Displays the monitor's current settings.

DDC/CI

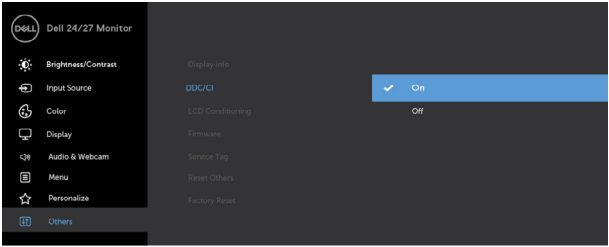
DDC/CI (Display Data Channel/Command Interface) allows your monitor parameters such as brightness, color balance, and so on to be adjustable through the software on your computer. You can disable this feature by selecting **Off**. Enable this feature for best user experience and optimum performance of your monitor.

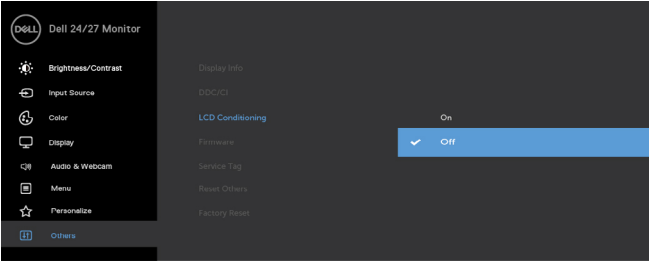

Icon	Menu and submenus	Description
	LCD Conditioning	Helps reduce minor cases of image retention. Depending on the degree of image retention, the program may take some time to run. You can enable this feature by selecting On .
	Display Info	DDDC/CI
	LCD Conditioning	On
	Firmware	✓ Off
	Service Tag	Reset Others
	Factory Reset	
	Firmware	Displays the firmware version of your monitor.
Service Tag	Displays the Service Tag. The Service Tag is a unique alphanumeric identifier that allows Dell to identify the product specifications and access warranty information.	NOTE: The Service Tag is also printed on a label that is at the back of the cover.
Reset Others	Resets all settings under the Others menu to the factory defaults.	Factory Reset
Restores all preset values to the factory default settings.		



OSD warning messages

When the monitor does not support a particular resolution mode, the following message is displayed.

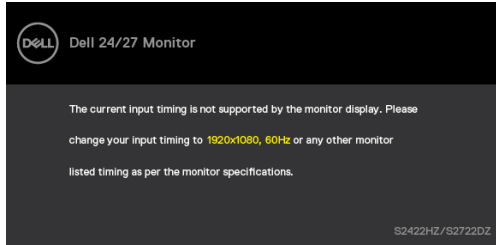

This message indicates that the monitor cannot synchronize with the signal that it is receiving from the computer. See [Monitor specifications](#) for the Horizontal and Vertical frequency ranges addressable by this monitor. Recommended mode is **1920 x 1080 (S2422HZ)/2560 x 1440 (S2722DZ)**.

The following message is displayed before the DDC/CI function is disabled.

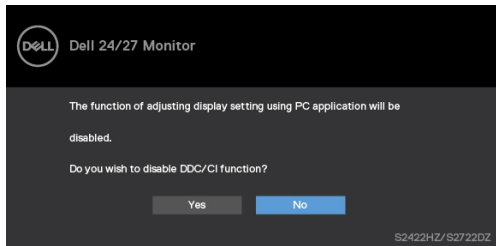

When the monitor enters the **Standby** mode, the following message is displayed.

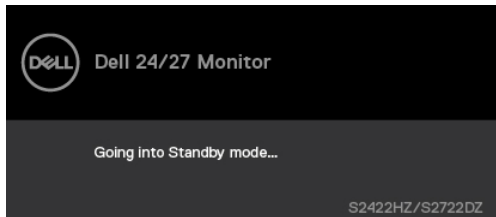

Activate the computer and wake up the monitor to gain access to the [OSD](#).



When the USB-C upstream cable is not connected, the microphone and webcam module is inactive, and the following message is displayed.

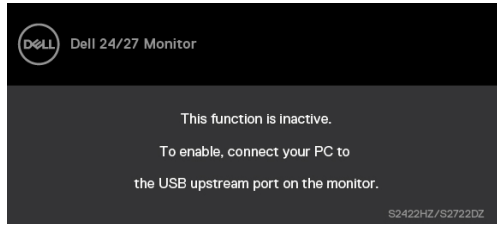

When you disable webcam only, the following message is displayed.

By default, **No** is selected. You can select “**Yes**” or “**Yes, and do not ask again.**”

If you reset Audio and Webcam, or if you restore factory setting, the following message is displayed again.

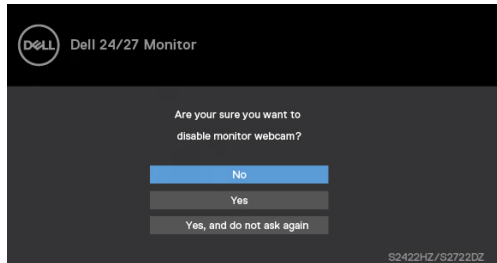

If you have disabled webcam in OSD, and then you press or retract the webcam, the following message is displayed.

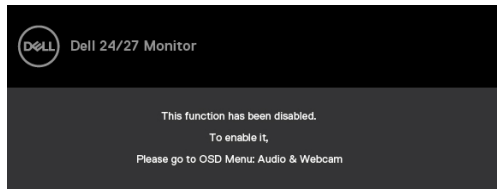

Status indicator is a semi transparent box that is aligned to the center and appears at the top of the screen, showing the status of speaker, microphone, and webcam.

When you change the status of speaker, microphone, webcam, or pop in or out of webcam module, the status indicator appears for two seconds.



If you want to disable it, select “Audio & Webcam->Status Indicator->Off” in the OSD menu.

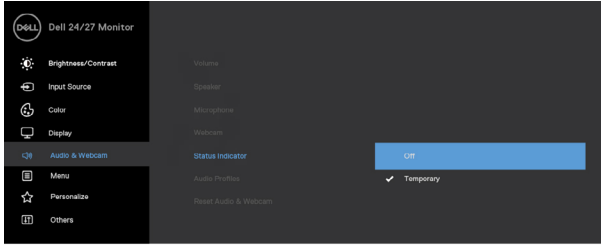

If you press any button other than the power button, the following messages appear depending on the selected input.

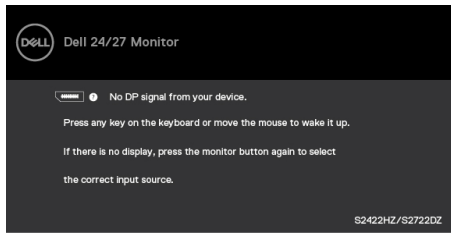

A message is displayed while the cable supporting DP alternate mode is connected to the monitor under the following conditions:

- When Auto select for **USB-C** is set to **Prompt for Multiple Inputs**.
- When the USB-C cable is connected to the monitor.

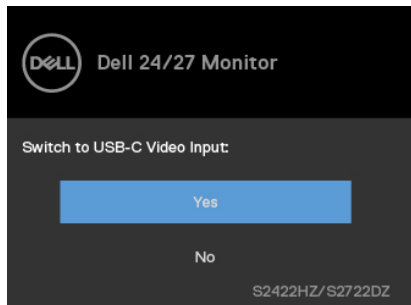

The following message is displayed if you select OSD items of **Factory Reset** in Other feature.

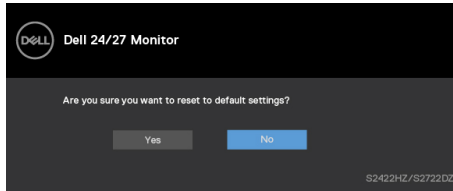

The following message is displayed when you select 'Yes' to reset to default settings.

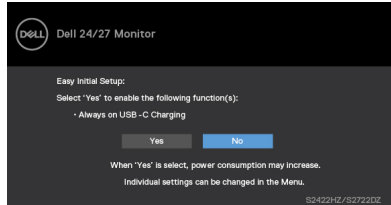

Select OSD items of **On in Standby Mode**  in Personalize feature, the following message is displayed.

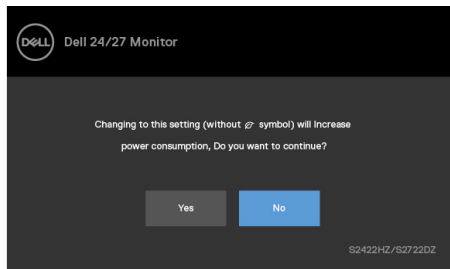

If you adjust the brightness level above the default level beyond 75%, the following message is displayed.

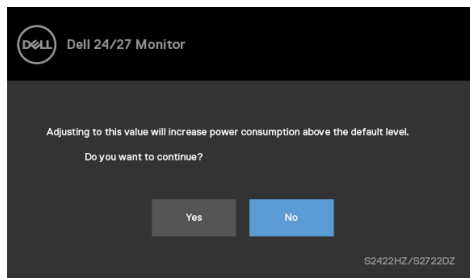

- When you select "Yes", the power message is displayed only once.
- When you select 'No', the power warning message is displayed again.



- The power warning message appears again only when you do a Factory Reset from the OSD menu.

If USB-C, DP, or HDMI input is selected and the corresponding cable is not connected, the following dialog box is displayed.

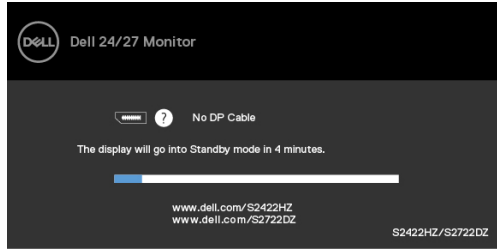

or

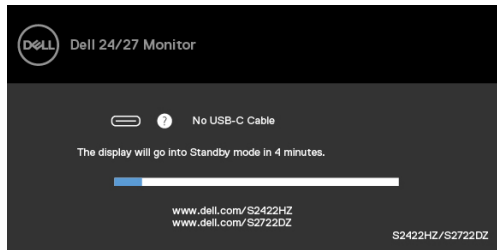

or

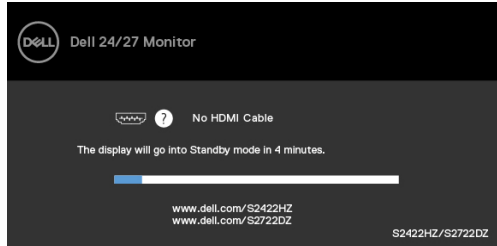

NOTE: For microphone and webcam to work, you must connect the USB-C to C upstream cable from the computer to the monitor.

See [Troubleshooting](#) for more information.



Setting the maximum resolution

In Windows 7, Windows 8, or Windows 8.1:

1. For Windows 8 or Windows 8.1 only, select the Desktop tile to switch to classic desktop. For Windows Vista and Windows 7, skip this step.
2. Right-click the desktop and click **Screen Resolution**.
3. Click the **Screen Resolution** drop-down list and select **1920 x 1080 (S2422HZ)/2560 x 1440 (S2722DZ)**.
4. Click **OK**.

In Windows 10:

1. Right-click the desktop and click **Display Settings**.
2. Click **Advanced display settings**.
3. Click **Resolution** drop-down list and select **1920 x 1080 (S2422HZ)/2560 x 1440 (S2722DZ)**.
4. Click **Apply**.

If you do not see **1920 x 1080 (S2422HZ)/2560 x 1440 (S2722DZ)** as an option, you may have to update your graphics driver. Depending on your computer, complete one of the following procedures:

1. If you have a Dell desktop or laptop, go to <https://www.dell.com/support>, enter your service tag, and download the latest driver for your graphics card.
2. If you are using a non-Dell computer (laptop or desktop):
 - Go to your computer manufacturer support website and download the latest graphic drivers.
 - Go to your graphics card manufacturer website and download the latest graphic drivers.



Setting up Windows Hello

In Windows 10:

1. Click Windows start menu, click **Settings**.

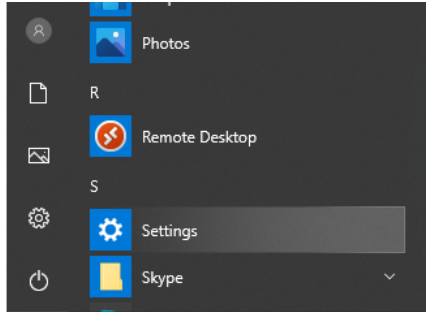

2. Click **Accounts**.

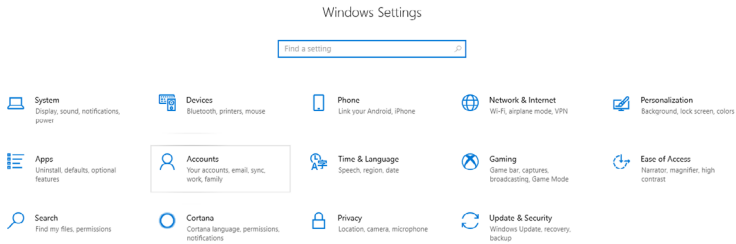

3. Click **Sign-in options**. Set a PIN before you enroll in Windows Hello.

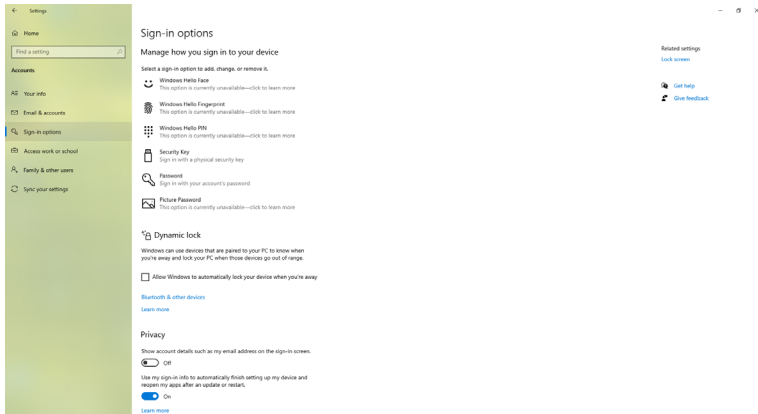

4. Click **Add** under **PIN**, enter to **Set up a PIN**. Enter New PIN and Confirm PIN, and then click **Next**.

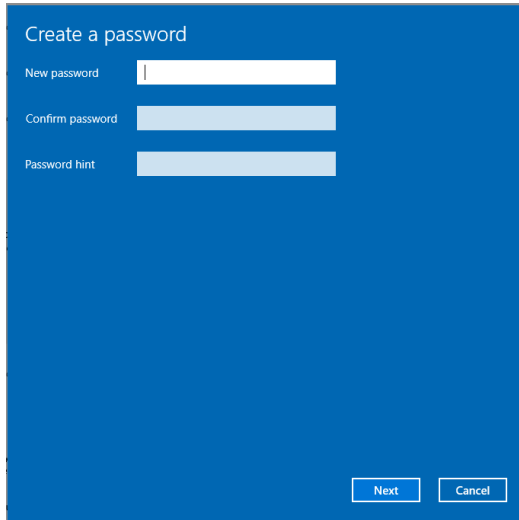

After you complete setting the PIN, the options to set up Windows Hello will unlock.

5. Click **Set up** under **Windows Hello**, enter to **Windows Hello setup**.

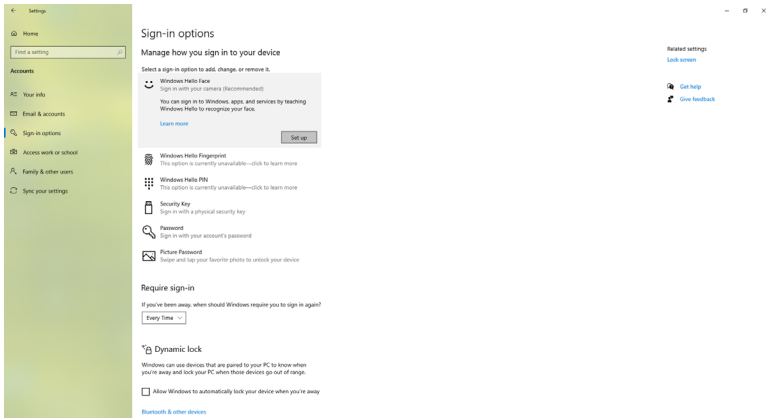

6. Click Get started.

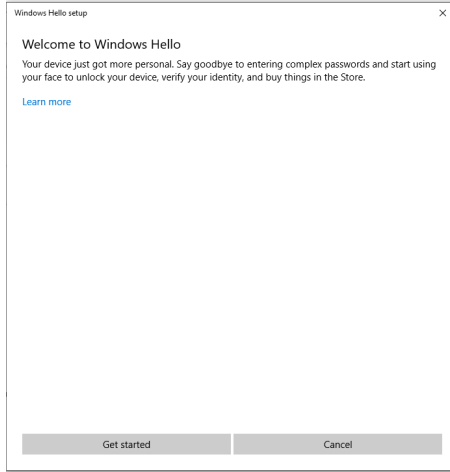

- 7.** Keep looking directly at your screen and position yourself so that your face is in the center of the frame that appears on screen. The webcam registers your face.

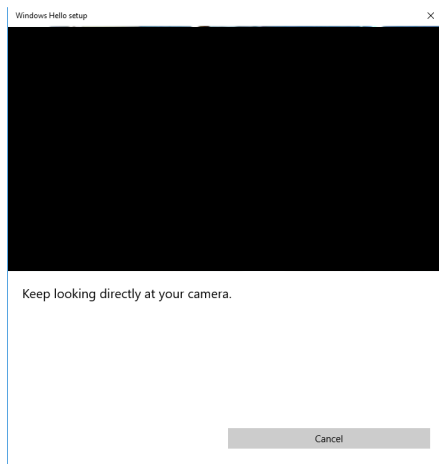

8. When the following message is displayed, click **Close** to exit **Windows Hello setup**.

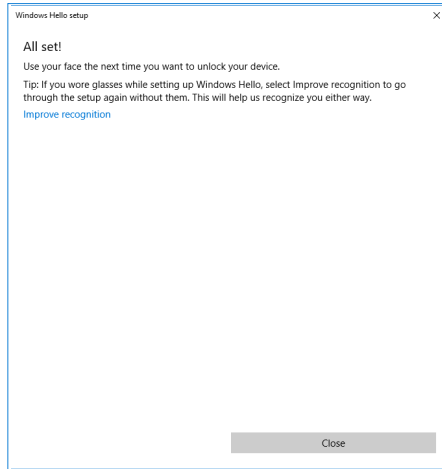

9. After the Windows Hello setup is complete, you can also improve the recognition. Click **Improve recognition**, if necessary.



Setting up the monitor webcam as default setting

When using a computer with built-in webcam to connect this monitor, in the device manager interface, you can find the computer built-in webcam and the monitor webcam. By default, they are enabled and the default setting is using computer built-in webcam.

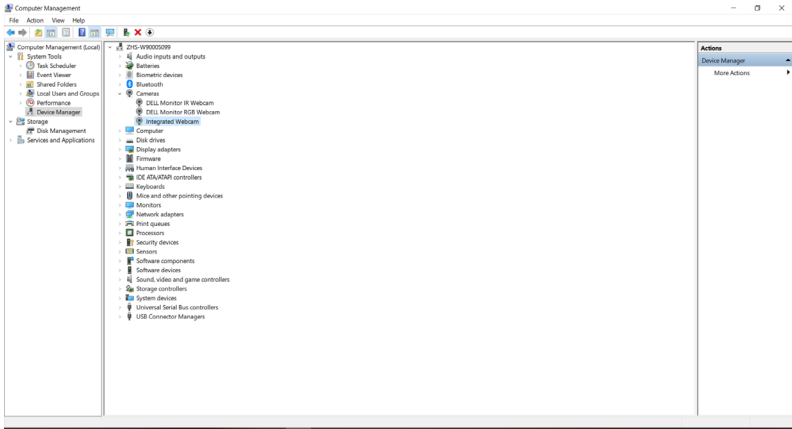

If you want to set up the monitor webcam as default setting, you must disable the computer built-in webcam. Follow these instructions to identify the computer built-in webcam and disable it:

1. Right-click **Dell Monitor Webcam**, and click **Properties** to open the **Dell Monitor Webcam Properties**.

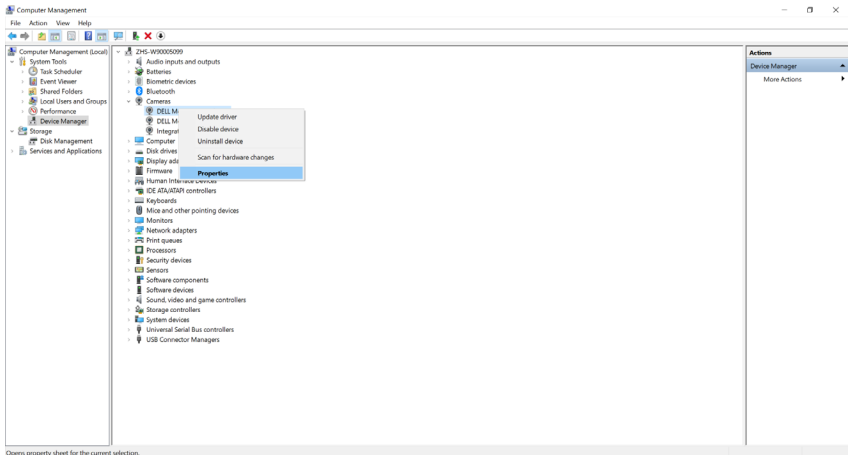

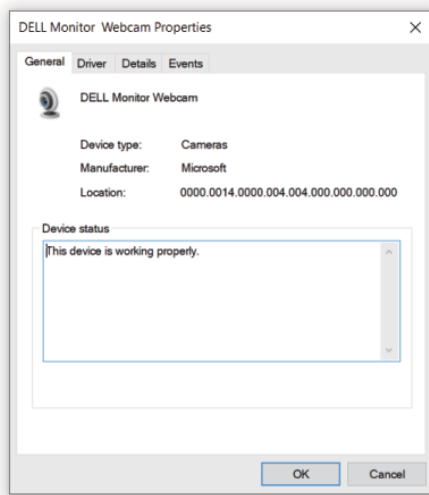

2. Click the **Details** tab. From the **Property** drop-down list, select **Hardware Ids**.

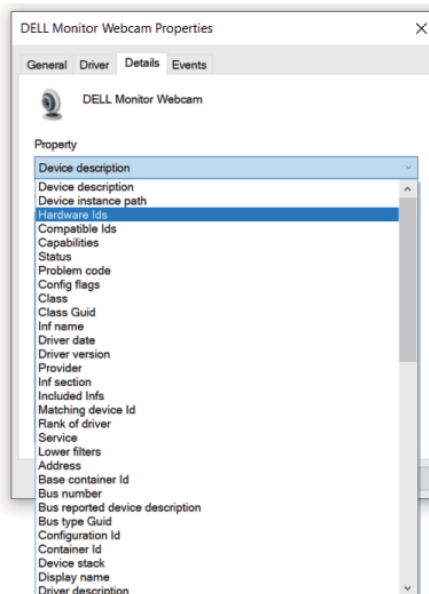

3. The **Value** section shows the detail hardware ids of this Dell Monitor IR Webcam. The hardware ids of the computer built-in webcam and the monitor webcam are different. The monitor webcam hardware ids are displayed as shown in the following image.

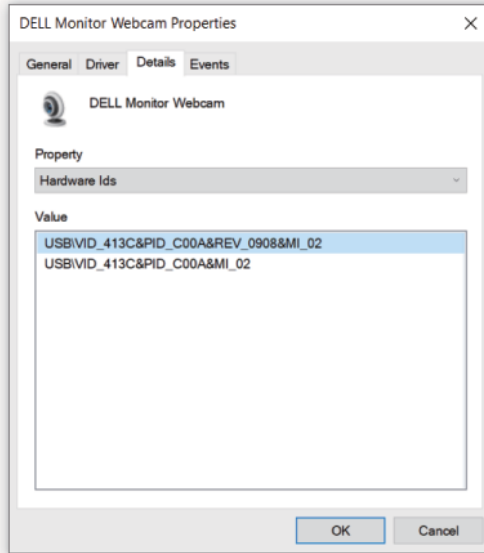

4. Right-click your computer webcam that has different hardware ids, and then click **Disable device**.

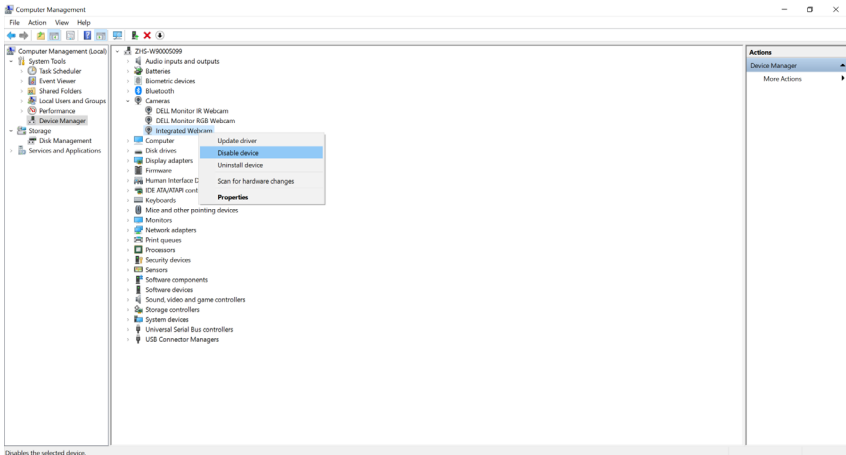

The following message is displayed.

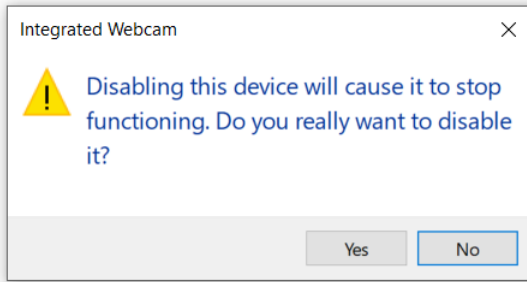

5. Click **Yes**. The computer webcam is now disabled and the monitor webcam is used as the default setting.

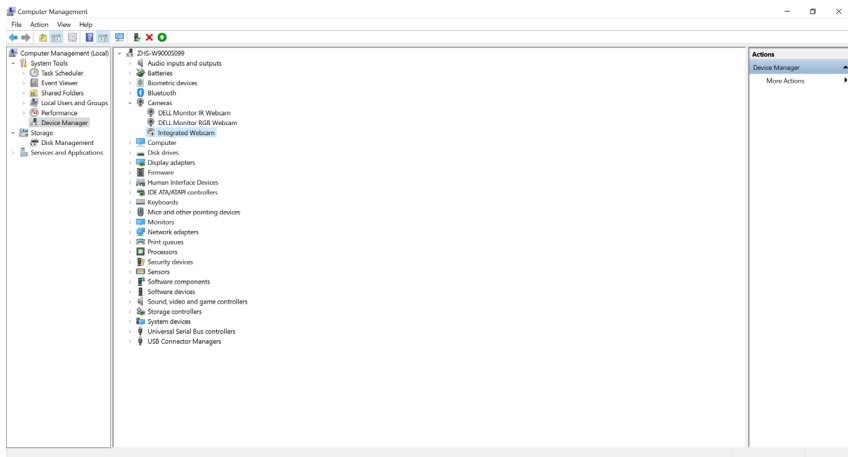

6. Restart the computer.



Setting up the monitor speaker as default setting

Follow these steps when your computer is connected to multiple speakers and if you want to set up the monitor speaker as the default setting:

1. Click the **Volume** icon in the Windows task bar notification area.



2. Click **Playback devices** to open the **Sound** dialog box. Click the playback device.

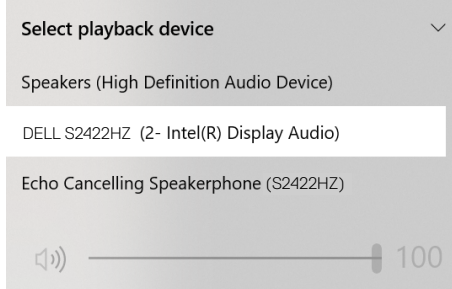

3. If only the HDMI or DP cable is connected from your monitor to the computer, only one speaker that is named as **DELL S2422HZ** or **DELL S2722DZ** is displayed in the **Sound** dialog box.

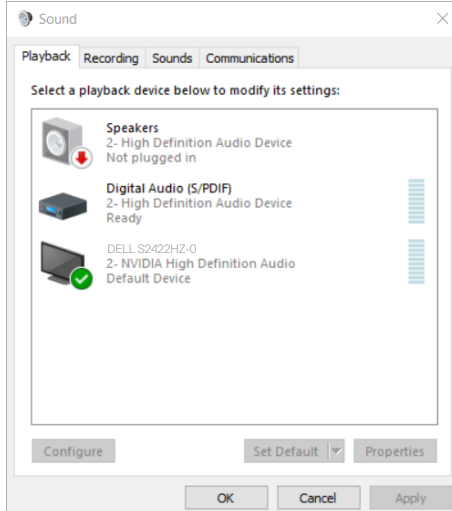

4. Select **DELL S2422HZ** or **DELL S2722DZ**, and then click **Set Default**. The monitor speaker is used as the default setting.

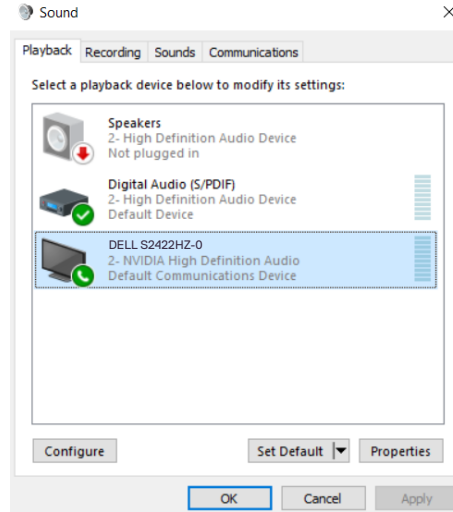

5. Click **OK** to close the **Sound** dialog box.

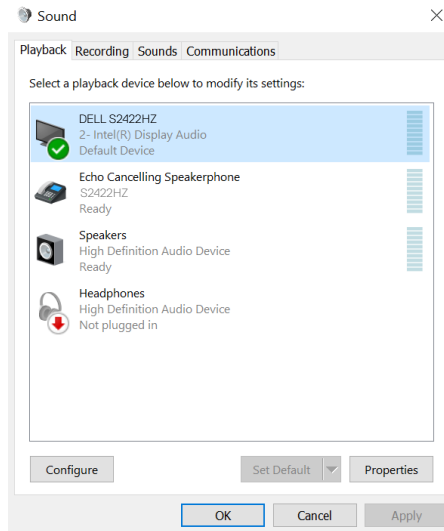

6. If the USB cable and the HDMI or DP cable are connected from monitor to the computer, two audio paths named **DELL S2422HZ** or **S2722DZ** and **Echo Cancelling Speakerphone (S2422HZ or S2722DZ)** from the monitor will show in the **Sound** dialog box. The **S2422HZ** or **S2722DZ** monitor would show options for two audio paths supported in the monitor.
- **Echo Cancelling Speakerphone (S2422HZ or S2722DZ)** audio path is where audio streams through USB. This is either through USB-C to USB-C cable or USB-A to USB-C cable. As the microphone path streams from monitor back to computer through USB, this selection is required for VoIP/ UC conference applications. Audio Recording and Playback works in this selection.
 - **DELL S2422HZ or S2722DZ** audio path is where audio streams through HDMI/DP/DP alternate mode. Microphone is not supported in this selection. This selection is suitable for Audio Playback only.

Audio Playback performance is same for both audio path options. Under normal Playback with USB-C to USB-C/USB-A to USB-C and/or for UC conference applications, it is recommended to select the default **Echo Cancelling Speakerphone (S2422HZ or S2722DZ)** audio path.

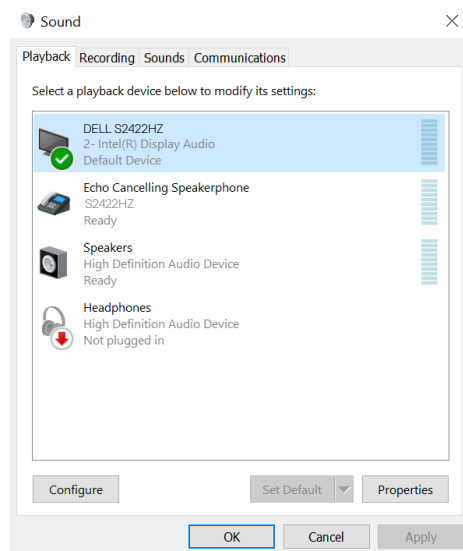

Troubleshooting

⚠ WARNING: Before you begin working on the following steps, follow the [Safety instructions](#).

Self-test

Your monitor provides a self-test feature that allows you to check whether your monitor is functioning properly. If your monitor and computer are properly connected but the monitor screen remains dark, run the monitor self-test by performing the following steps:

1. Turn off both your computer and the monitor.
2. Unplug the video cable from the back of the computer. To ensure proper Self-Test operation, remove all digital and the analog cables from the back of computer.
3. Turn on the monitor.

The following dialog box appears on the screen (against a black background), when the monitor cannot sense a video signal and is working correctly. While in self-test mode, the power LED remains white. Depending upon the selected input, one of the following dialog boxes will continuously scroll through the screen.

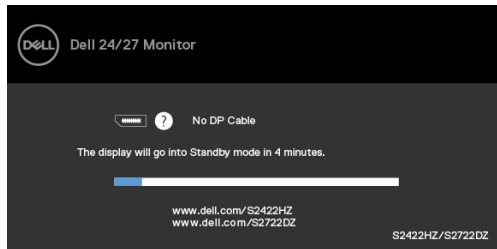

OR

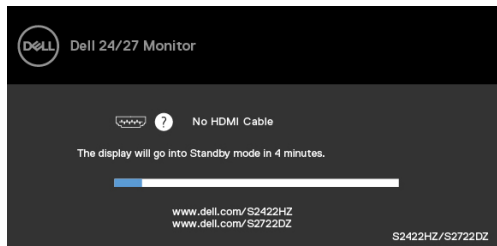

OR



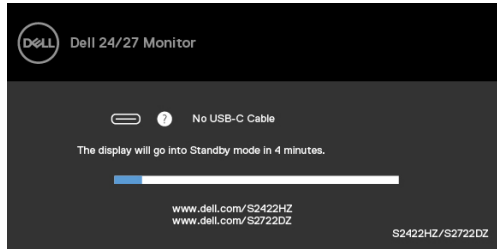

This dialog box also appears during normal operation and when the video cable is disconnected or damaged.

4. Turn off your monitor and reconnect the video cable; Then, turn on both your computer and the monitor.

If your monitor screen remains blank after you use the previous procedure, check your video controller and computer, as your monitor is functioning properly.

Built-in diagnostics

Your monitor has a built-in diagnostic tool. It helps you determine if the screen abnormality that you are experiencing is an inherent problem with your monitor, or with your computer and video card.

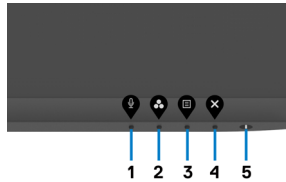

To run the built-in diagnostics:

1. Ensure that the screen is clean (no dust particles on the surface of the screen).
2. Press and hold **Button 4** for four seconds, a menu appears on the screen.
3. Select the Built-in diagnostics  option. A gray screen is displayed.
4. Observe if the screen has any defects or abnormalities.
5. Press **Button 1** on the front panel again. The color of the screen changes to red.
6. Observe if the screen has any defects or abnormalities.
7. Repeat steps 5 and 6 until the screen displays green, blue, black, and white colors. Note any abnormalities or defects.

The test is complete when the text screen is displayed. To exit, press **Button 1** again.

If you do not detect any screen abnormalities upon using the built-in diagnostic tool, the monitor is functioning properly. Check the video card and computer.



Common problems

The following table contains general information about common monitor problems you might encounter and the possible solutions:

Common symptoms	What you experience	Possible solutions
No video/ Power LED off	No picture	<ul style="list-style-type: none">• Ensure that the video cable connecting the monitor and the computer is connected properly and secure.• Verify that the power outlet is functioning properly using any other electrical equipment.• Ensure that the power button is pressed fully.• Ensure that the correct input source is selected in the Input Source menu.
No video/ Power LED on	No picture or no brightness	<ul style="list-style-type: none">• Increase brightness and contrast controls through OSD.• Perform monitor self-test feature check.• Check for bent or broken pins in the video cable connector.• Run the built-in diagnostics.• Ensure that the correct input source is selected in the Input Source menu.
Missing pixels	LCD screen has spots	<ul style="list-style-type: none">• Cycle power On-Off.• Pixel that is permanently off is a natural defect that can occur in LCD technology.• For more information about Dell Monitor Quality and Pixel Policy, see Dell Support site at https://www.dell.com/pixelguidelines.
Stuck-on pixels	LCD screen has bright spots	<ul style="list-style-type: none">• Cycle power On-Off.• Pixel that is permanently off is a natural defect that can occur in LCD technology.• For more information about Dell Monitor Quality and Pixel Policy, see Dell Support site at https://www.dell.com/pixelguidelines.
Brightness problems	Picture too dim or too bright	<ul style="list-style-type: none">• Reset the monitor to factory settings.• Adjust brightness and contrast controls through OSD.
Safety-related issues	Visible signs of smoke or sparks	<ul style="list-style-type: none">• Do not perform any troubleshooting steps.• Contact Dell immediately.



Common symptoms	What you experience	Possible solutions
Intermittent problems	Monitor malfunctions on and off	<ul style="list-style-type: none"> • Ensure that the video cable connecting the monitor to the computer is connected properly and is secure. • Reset the monitor to factory settings. • Perform monitor self-test feature check to determine if the intermittent problem occurs in self-test mode.
Missing color	Picture missing color	<ul style="list-style-type: none"> • Perform monitor self-test. • Ensure that the video cable connecting the monitor to the computer is connected properly and is secure. • Check for bent or broken pins in the video cable connector.
Wrong color	Picture color not good	<ul style="list-style-type: none"> • Change the settings of the Preset Modes in the Color menu OSD depending on the application. • Adjust R/G/B value under Custom Color in Color menu OSD. • Change the Input Color Format to PC RGB or YCbCr in the Color menu OSD. • Run the built-in diagnostics.
Image retention from a static image left on the monitor for a long period	Faint shadow from the static image that is displayed appears on the screen	<ul style="list-style-type: none"> • Set the screen to turn off after a few minutes of screen idle time. It can be adjusted in Windows Power Options or Mac Energy Saver setting. • Alternatively, use a dynamically changing screensaver.
Webcam does not work	<ul style="list-style-type: none"> • Webcam module does not pop up • USB cable not plugged in or the correct USB source is not selected 	<ul style="list-style-type: none"> • Retract the webcam module. • Plug in the USB cable. • Select the monitor webcam as the default in the computer.



Product specific problems

Problem	What you experience	Possible solutions
Screen image is too small	Image is centered on screen, but does not fill entire viewing area.	<ul style="list-style-type: none">• Check the Aspect Ratio setting in the Display menu OSD.• Reset the monitor to factory settings.
Cannot adjust the monitor with the buttons on the front panel	OSD does not appear on the screen	<ul style="list-style-type: none">• Turn off the monitor, unplug the monitor power cable, plug it back, and then turn on the monitor.
No input signal when user controls are pressed	No picture. The LED light is white.	<ul style="list-style-type: none">• Check the signal source. Ensure that the computer is not in the power-saving mode by moving the mouse or pressing any key on the keyboard.• Check whether the signal cable is plugged in properly. Connect the signal cable again, if necessary.• Reset the computer or video player.
The picture does not fill the entire screen	The picture cannot fill the height or width of the screen	<ul style="list-style-type: none">• Due to different video formats (aspect ratio) of DVDs, the monitor may display in full screen.• Run the built-in diagnostics.
No image when using DP connection to the computer	Blank screen	<ul style="list-style-type: none">• Verify if your graphics card is certified to DP 1.1a or DP 1.2 DP standard. Download and install the latest graphics card driver.• Some DP 1.1a graphics card cannot support DP 1.2 monitors. Go to OSD menu, under Input Source.
No image when using USB-C connection to computer, laptop, and so on	Blank screen	<ul style="list-style-type: none">• Verify if the USB-C interface of the device can support DP alternate mode.• Verify if the device required power charging.• USB-C interface of device cannot support DP alternate mode.• Set Windows to Projection mode.• Ensure that the USB-C cable is not damaged.



Problem	What you experience	Possible solutions
Not charging when using USB-C connection to computer, laptop, and so on	Not charging	<ul style="list-style-type: none"> • Verify if the device can support one of 5 V/9 V/15 V/20 V charging profiles. • Verify if the computer requires more than 65 W power adaptor. • If the computer requires more than 65 W power adaptor, it may not charge with the USB-C connection. • Ensure that you use only Dell approved adapter or the adapter that comes with the product. • Ensure that the USB-C cable is not damaged.
Intermittent charging when using USB-C connection to computer, laptop, and so on	Intermittent charging	<ul style="list-style-type: none"> • Check if the maximum power consumption of device is over 65 W. • Ensure that you use only Dell approved adapter or the adapter that comes with the product. • Ensure that the USB-C cable is not damaged.
Video recording not working	Video recording App not working with Windows 7	<ul style="list-style-type: none"> • Windows 7 is not supported. • Switch to Windows 10.
No sound heard from recorded video	No sound can be heard from recorded video with 11th Generation Tiger Lake processor	Disable Intel Smart Sound Technology for USB Audio driver in the Device Manager and restart the computer.
When you press Volume down or Volume up, OSD volume bar response is lagging or delayed.	When you press Volume down or Volume up, OSD volume bar response is lagging or delayed with monitor having 11th Generation Tiger Lake processor	Disable Intel Smart Sound Technology for USB Audio driver in the Device Manager and restart the computer.



Problem	What you experience	Possible solutions
Volume down or Volume up, OSD volume bar no response	When you press either Volume down or Volume up, OSD volume bar shows no response	Select Echo Cancelling Speakerphone (S2422HZ or S2722DZ) from Windows sound settings.
Volume of external audio devices cannot be adjusted	Volume of external audio devices cannot be adjusted	Select corresponding device in audio device list.
Mute or Unmute button on monitor, Mute icon on the UC platform is not sync	Mute or Unmute button on monitor, Mute icon on the UC platform is not sync	This is expected behavior. UC Platform not sync: Zoom, Google Hangouts, BlueJeans, Cisco Webex, Facetime, Slack, GoToMeeting.
No sound coming from the speakers	No sound coming from the speakers when you play audio/video on your computer	<ul style="list-style-type: none"> • Ensure that you have set the default playback device as Echo Cancelling Speakerphone (S2422HZ or S2722DZ) or DELL S2422HZ or S2722DZ. • Turn Off the monitor, unplug the monitor power cord, replug it, and then turn On the monitor. • Reset the monitor to Factory Settings.
Speaker volume is low or sounds soft	Speaker volume is low or sounds soft when speaker option is DELL S2422HZ or S2722DZ in Sound setting interface	<ul style="list-style-type: none"> • Increase the speaker volume of DELL S2422HZ or S2722DZ to maximum in the Sound dialog box. • Press the Volume Up button to increase the speaker volume of DELL S2422HZ or S2722DZ. • Set Microphone volume to 100 • Clean Microphone hole. • Close to monitor Microphone < 70cm.
OSD volume adjustment is lagging/delayed	OSD volume adjustment is lagging/delayed	Disable Intel Smart Sound Technology for USB Audio driver in the Device Manager and reboot computer.



Problem	What you experience	Possible solutions
Microphone not working or not detected	Microphone not working or not detected	<ul style="list-style-type: none"> • Ensure that the USB-C upstream cable is connected between the monitor and the computer or notebook. • Select “Echo Cancelling Speakerphone (S2422HZ or S2722DZ)” from Windows sound settings. Ensure that the monitor’s microphone is selected and enabled or unmuted on the setting in VoIP or UC application.
MAC MINI issue	MAC MINI issue	<ul style="list-style-type: none"> • The USB hub of the DUT cannot be detected by specific systems (Apple M1) when connecting DUT to the system through USB-C cable and then restarting the system. • Unplug or plug USB-C cable can recover.
Webcam is not detected	Webcam is not detected in the Windows Device Manager	<ul style="list-style-type: none"> • Ensure that the webcam module is popped up. • Ensure that the USB-C upstream cable is connected between the monitor and the computer or notebook. • Reconnect the USB-C upstream cable to the computer or laptop.
Webcam cannot connect or be disconnected	Cannot find camera in monitor or cannot change back to the computer camera	<ul style="list-style-type: none"> • Restore factory settings. Connect the power cord again. • Turn on the camera again.
Webcam blurry image	Webcam blurry image	Remove protection film on the camera lens.
Webcam image flicker	Webcam image flicker	Switch Flicker reduction rate from 60 Hz to 50 Hz in app.
Webcam poor resolution	Webcam poor resolution	Set image resolution in app.Max: 5MP (2560 x 1920)
Webcam image looks over-exposed	Webcam image looks over-exposed	<ul style="list-style-type: none"> • Turn on the camera again. Adjust the background environment. • Increase ambient light > 20lux



Problem	What you experience	Possible solutions
Webcam image looks grainy or dark	Webcam image looks grainy or dark	<ul style="list-style-type: none"> • Turn on the camera again. Adjust the background environment. • Increase ambient light > 20lux.
Camera cannot be focused	Camera cannot be focused	Adjust to suitable operating distance: 35 cm~70 cm.
Webcam image color is not accurate	Webcam image color is not accurate	Update to latest monitor firmware.
Webcam video noise	Webcam video noise	<ul style="list-style-type: none"> • Ensure webcam module is popped up. • Reconnect or replace the USB cable.
Webcam was working before the Windows update or driver update	Webcam was working before the Windows update or driver update	<ul style="list-style-type: none"> • Roll back driver to fix it • Restore Windows to an earlier restored point (if users ever set it)
Webcam is occupied and cannot be used	Webcam is occupied and cannot be used	Turn off conference software A before you run conference software B.
Windows OS level computer volume change, line out (when you select echo canceling speakerphone) volume cannot be adjustable	Windows OS level computer volume change, line out (when you select echo canceling speakerphone) volume should be adjustable	You can adjust the volume by adjusting the volume bar on the player APP (like media player), not Windows OS level or adjust the volume through the line out external speaker device.
Windows OS level computer mute, line out (when you select echo canceling speakerphone) continue to output audio	Windows OS level computer mute, line out (when you select echo canceling speakerphone) should be mute.	Select player APP (like media player) mute icon to mute or adjust the mute through the line out external speaker device.



Universal Serial Bus (USB) specific problems

Specific Symptoms	What You Experience	Possible Solutions
USB interface is not working	USB peripherals are not working	<ul style="list-style-type: none">• Ensure that your display is turned ON.• Reconnect the upstream cable to your computer.• Reconnect the USB peripherals (downstream connector).• Turn off the monitor and turn it on again.• Restart the computer.• Certain USB devices such as portable hard drives require higher power source; connect the drive to the computer directly.
Super speed USB 3.2 Gen 1 interface is slow.	Super speed USB 3.2 Gen 1 peripherals working slowly or not working at all	<ul style="list-style-type: none">• Ensure that your computer is USB 3.0-capable.• Some computers have USB 3.0, USB 2.0, and USB 1.1 ports. Ensure that the correct USB port is used.• Reconnect the upstream cable to your computer.• Reconnect the USB peripherals (downstream connector).• Restart the computer.
Wireless USB peripherals stop working when a USB 3.0 device is plugged in	Wireless USB peripherals responding slowly or only working as the distance between itself and its receiver decreases	<ul style="list-style-type: none">• Increase the distance between the USB 3.0 peripherals and the wireless USB receiver.• Position your wireless USB receiver as close as possible to the wireless USB peripherals.• Use a USB-extender cable to position the wireless USB receiver as far away as possible from the USB 3.0 port.
USB is not working	No USB functionalities	Refer to input source and USB pairing table.



Appendix

FCC notices (U.S. only) and other regulatory information

For FCC notices and other regulatory information, see the regulatory compliance website located at https://www.dell.com/regulatory_compliance.

Contacting Dell

For customers in the United States, call 800-WWW-DELL (800-999-3355).

 **NOTE: If you do not have an active Internet connection, you can find contact information on your purchase invoice, packing slip, bill, or Dell product catalog.**

Dell provides several online and telephone-based support and service options. Availability varies by country and product, and some services may not be available in your area.

To get online Monitor support content:

See <https://www.dell.com/support/monitors>.

To contact Dell for sales, technical support, or customer service issues:

1. Go to <https://www.dell.com/support>.
2. Verify your country or region in the Choose A Country/Region drop-down menu at the bottom-right corner of the page.
3. Click **Contact Us** next to the country drop-down list.
4. Select the appropriate service or support link based on your requirement.
5. Choose the method of contacting Dell that is convenient for you.

EU product database for energy label and product information sheet

S2422HZ: <https://eprel.ec.europa.eu/qr/755430>

S2722DZ: <https://eprel.ec.europa.eu/qr/755450>



Free Manuals Download Website

<http://myh66.com>

<http://usermanuals.us>

<http://www.somanuals.com>

<http://www.4manuals.cc>

<http://www.manual-lib.com>

<http://www.404manual.com>

<http://www.luxmanual.com>

<http://aubethermostatmanual.com>

Golf course search by state

<http://golfingnear.com>

Email search by domain

<http://emailbydomain.com>

Auto manuals search

<http://auto.somanuals.com>

TV manuals search

<http://tv.somanuals.com>