

User's Guide

Dell E2015HV

Dell E2215HV

Dell E2715H

Model No.: E2015HV / E2215HV / E2715H

Regulatory model: E2015HVf / E2215HVf / E2715Hf





NOTE: A NOTE indicates important information that helps you make better use of your monitor.



CAUTION: A CAUTION indicates potential damage to hardware or loss of data if instructions are not followed.



WARNING: A WARNING indicates a potential for property damage, personal injury, or death.

© 2014 Dell Inc. All rights reserved.

Information in this document is subject to change without notice. Reproduction of these materials in any manner whatsoever without the written permission of Dell Inc. is strictly forbidden.

Trademarks used in this text: *Dell* and the *DELL* logo are trademarks of Dell Inc. Microsoft and Windows are either registered trademarks or trademarks of Microsoft Corporation in the United States and/ or other countries. ENERGY STAR is a registered trademark of the U.S. Environmental Protection Agency. As an ENERGY STAR partner, Dell Inc. has determined that this product meets the ENERGY STAR guidelines for energy efficiency.

Other trademarks and trade names may be used in this document to refer to either the entities claiming the marks and names or their products. Dell Inc. disclaims any proprietary interest in trademarks and trade names other than its own.

2014 – 07 Rev. A00

Contents

Dell Display Manager User's Guide	6
Overview	6
Using the Quick Settings Dialog	6
Setting Basic Display Functions	7
Assigning Preset Modes to Applications	7
Applying Energy-Conservation Features	9
About Your Monitor	10
Package Contents	10
Product Features	11
Identifying Parts and Controls	12
Monitor Specifications	15
Power Management Modes	15
Pin Assignments	18
Plug and Play Capability	21
Flat-Panel Specifications	21
Resolution Specifications	22
Electrical Specifications	22
Preset Display Modes	23
Physical Characteristics	23
Environmental Characteristics	25
LCD Monitor Quality & Pixel Policy	26
Maintenance Guidelines	26
Caring for Your Monitor	26

Setting Up the Monitor	27
Attaching the Stand	27
Connecting Your Monitor	29
Connecting the blue VGA Cable	29
Connecting the white DVI cable (for E2715H only)	30
Connecting the white DP cable (for E2715H only).	30
Organizing Your Cables (for E2215HV / E2715H)	30
Attaching the Cable Cover (for only E2715H)	31
Removing the Monitor Stand	31
Wall Mounting (Optional)	33
Operating the Monitor	34
Power On the Monitor	34
Using the Front-Panel Controls	34
Front-Panel Keys	35
Using the On-Screen Display (OSD) Menu	36
Accessing the Menu System	36
OSD Messages	53
Setting the Maximum Resolution	57
Using the Tilt.	58
Troubleshooting	59
Self-Test	59
Built-in Diagnostics.	60
Common Problems.	61
Product-Specific Problems	63
Dell Soundbar Problems.	64
Appendix	67

FCC Notices (U.S. Only) and Other Regulatory Information	67
Contact Dell	67
Setting Up Your Monitor	68
Setting the display resolution to 1600 x 900 (for E2015HV) or 1920 x 1080 (for E2215HV/E2715H) (Maximum)	68
If you have a Dell desktop or a Dell portable computer with Internet access	69
If you have a non Dell desktop, portable computer, or graphics card	69
Procedures for setting up dual monitors in Windows Vista , Windows 7 , Windows 8 or Windows 8.1	70
For Windows Vista®.	70
For Windows® 7	72
For Windows® 8 or Windows 8.1.	74
Setting Display Styles For Multiple Monitor	76

Dell Display Manager User's Guide

Overview

Dell Display Manager is a Windows application used to manage a monitor or a group of monitors. It allows manual adjustment of the displayed image, assignment of automatic settings, energy management, image rotation and other features on select Dell models. Once installed, Dell Display Manager will run each time the system starts and will place its icon in the notification tray. Information about monitors connected to the system is always available when hovering over the notification tray icon.

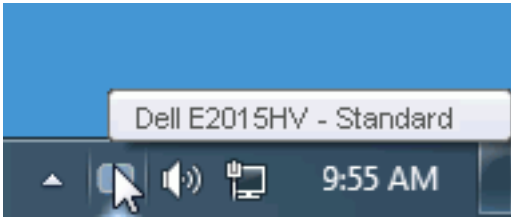

Using the Quick Settings Dialog

Clicking Dell Display Manager's notification tray icon opens the Quick Settings dialog box. When more than one supported Dell model is connected to the system, a specific target monitor can be selected using the menu provided. The Quick Settings dialog box allows convenient adjustment of the monitor's Brightness and Contrast levels, Preset Modes can be manually selected or set to Auto Mode, and the screen resolution can be changed.

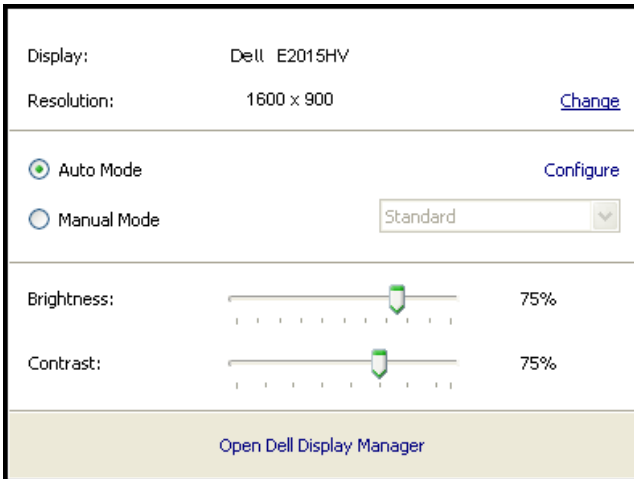

The Quick Settings dialog box also provides access to Dell Display Manager's advanced user interface which is used to adjust Basic functions, configure Auto Mode and access other features.

Setting Basic Display Functions

A Preset Mode for the selected monitor can be manually applied using the menu on the Basic tab. Alternatively, Auto Mode can be enabled. Auto Mode causes your preferred Preset Mode to be applied automatically when specific applications are active. An onscreen message momentarily displays the current Preset Mode whenever it changes.

The selected monitor's Brightness and Contrast can also be directly adjusted from the Basic tab.

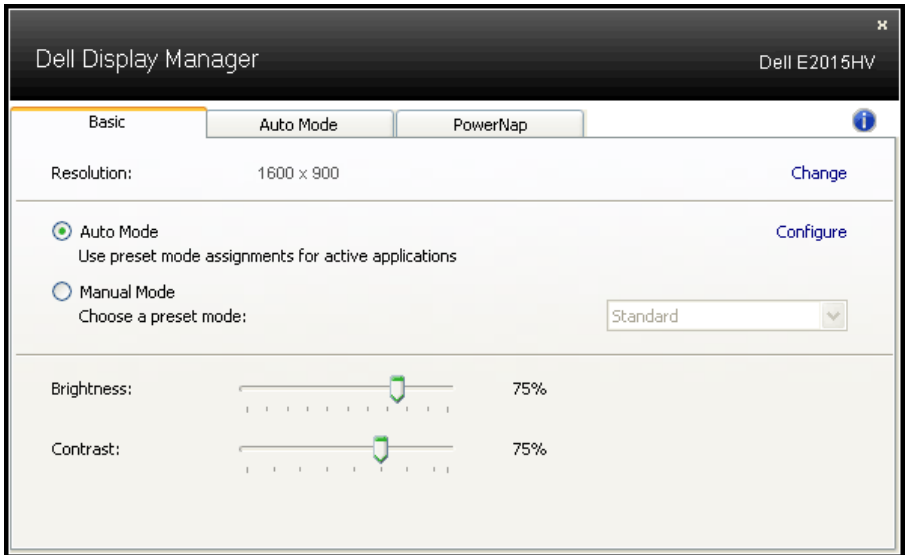

Assigning Preset Modes to Applications

The Auto Mode tab allows you to associate a specific Preset Mode with a specific application, and apply it automatically. When Auto Mode is enabled, Dell Display Manager will automatically switch to the corresponding Preset Mode whenever the associated application is activated. The Preset Mode assigned to a particular application may be the same on each connected monitor, or it can vary from one monitor to the next.

Dell Display Manager is pre-configured for many popular applications. To add a new application to the assignment list, simply drag the application from the desktop, Windows Start Menu or elsewhere, and drop it onto the current list.

NOTE: Preset Mode assignments targeting batch files, scripts, and loaders, as well as non-executable files such as zip archives or packed files, are not supported and will be ineffective.

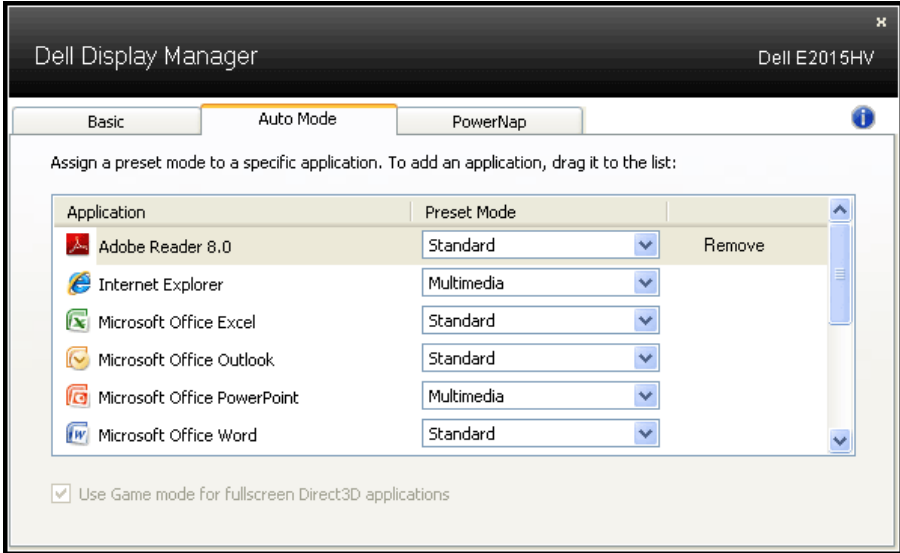

Applying Energy-Conservation Features

On supported Dell models, the PowerNap tab will be available to provide energy conservation options. When the screensaver activates, the monitor's Brightness can automatically be set to minimum level or the monitor can be put to sleep in order to save additional power.

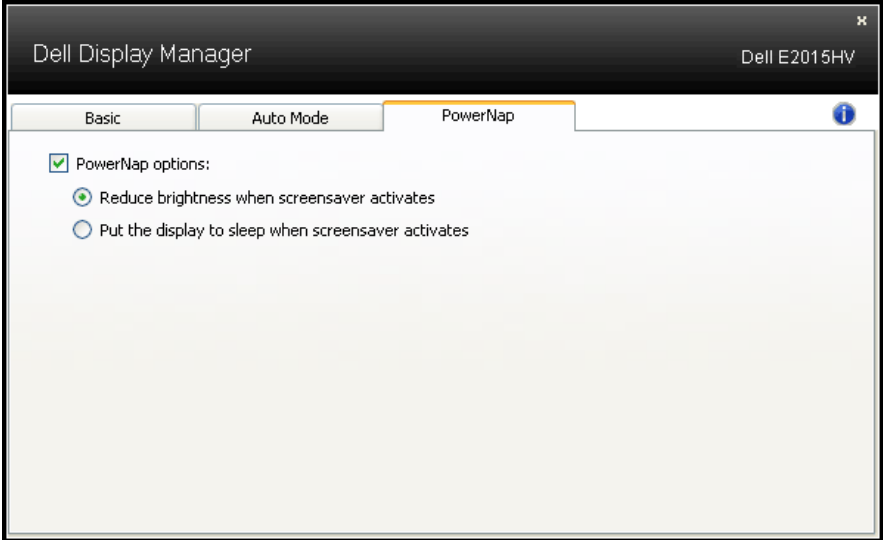



About Your Monitor

Package Contents

Your monitor ships with all the components shown below. Ensure that you have received all the components and **Contact Dell** if anything is missing.

 **NOTE:** Some items may be optional and may not ship with your monitor. Some features or media may not be available in certain countries.

	• Monitor
 E2015HV E2215HV E2715H	• Stand Riser
 E2015HV / E2215HV E2715H	• Stand Base
 E2015HV / E2215HV	• VESA™ Screw Cover
 E2715H	• Cable Cover
	• Power Cable (varies with countries)
	• VGA Cable

 <p style="text-align: center;">E2715H</p>	<ul style="list-style-type: none"> • DVI Cable
	<ul style="list-style-type: none"> • Drivers and Documentation media • Quick Setup Guide • Safety and Regulatory Information

Product Features

The Dell E2015HV/E2215HV/E2715H flat-panel display has an active matrix, Thin-Film Transistor, Liquid Crystal Display and LED backlight. The monitor's features include:

- **E2015HV**: 49.53cm (19.5 inches) diagonal viewable image size, 1600 x 900 resolution, plus full-screen support for lower resolutions.
- **E2215HV**: 54.69 cm (21.5 inches) diagonal viewable image size, 1920 x 1080 resolution, plus full-screen support for lower resolutions.
- **E2715H**: 68.58 cm (27.0 inches) diagonal viewable image size, 1920 x 1080 resolution, plus full-screen support for lower resolutions.
- Tilt adjustment capability.
- Removable pedestal and Video Electronics Standards Association (VESA) 100 mm mounting holes for flexible mounting solutions.
- Plug and play capability if supported by your system.
- On-Screen Display (OSD) adjustments for ease of set-up and screen optimization.
- Software and documentation media which includes an information file (INF), Image Color Matching File (ICM), and product documentation.
- Dell Display Manager Software
- ENERGY STAR-compliant.
- Security lock slot.
- **E2715H**: Stand lock.
- Asset Management Capability.
- **E2015HV/E2215HV**: EPEAT Sliver compliant.
- **E2715H**: EPEAT Gold compliant.
- CECP (for China).
- RoHS compliant.

- **E2715H:** TCO Certified Displays.
- **E2015HV/E2215HV:** Supports VGA.
- **E2715H:** Supports VGA, DVI-D, Displayport 1.2.
- Energy Gauge shows the energy level being consumed by the monitor in real time.

Identifying Parts and Controls

Front View

E2015HV:



E2215HV/E2715H:



1.	Function buttons (For more information, see Operating the Monitor)
2	Power On/Off button (with LED indicator)

Back View

E2015HV:

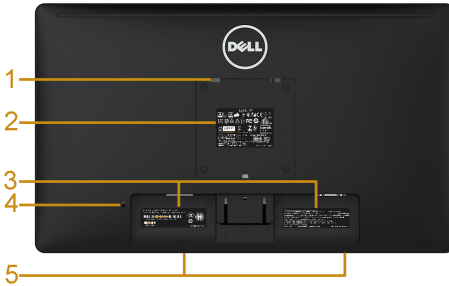

E2015HV



Back View with Monitor Stand

Label	Description	Use
1	VESA mounting holes (100 mm)	To mount the monitor.
2	Regulatory rating label	Lists the regulatory approvals.
3	Barcode serial number label	Refer to this label if you need to contact Dell for technical support.
4	Security lock slot	Secures monitor with security lock (security lock not included).
5	Dell soundbar mounting slots	To attach the optional Dell Soundbar.

E2215HV:

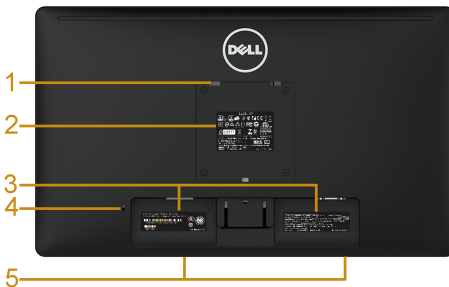

E2215HV



Back View with Monitor Stand

Label	Description	Use
1	VESA mounting holes (100 mm)	To mount the monitor.
2	Regulatory rating label	Lists the regulatory approvals.
3	Barcode serial number label	Refer to this label if you need to contact Dell for technical support.
4	Security lock slot	Secures monitor with security lock (security lock not included).
5	Dell soundbar mounting slots	To attach the optional Dell Soundbar.
6	Cable management slot	Use to organize cables by placing them through the slot.

E2715H:

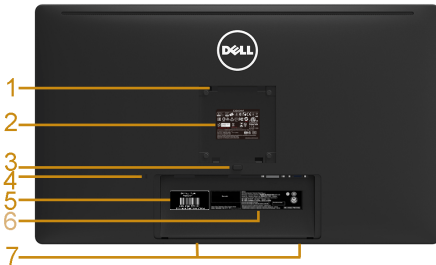

E2715H



Back View with Monitor Stand

Label	Description	Use
1	VESA mounting holes (100 mm)	To mount the monitor.
2	Regulatory rating label	Lists the regulatory approvals.
3	Stand release button	Release stand from monitor.
4	Security lock slot	Secures monitor with security lock (security lock not included).
5	Service Tag Label	The Dell service tag is used for Dell warranty and customer service management purposes and for records of the base system.
6	Barcode serial number label	Refer to this label if you need to contact Dell for technical support.
7	Dell soundbar mounting slots	To attach the optional Dell Soundbar.
8	Cable management slot	Use to organize cables by placing them through the slot.

Side View



E2015HV/E2215HV

E2715H

Right Side

Bottom View

E2015HV/E2215HV:



Label	Description	Use
1	AC power connector	To connect the monitor power cable.
2	VGA connector	To connect your computer to the monitor using a VGA cable.

E2715H:



Label	Description	Use
1	AC power connector	To connect the monitor power cable.
2	Displayport connector	To connect your computer to the monitor using a DP cable.
3	DVI connector	To connect your computer to the monitor using a DVI cable.
4	VGA connector	To connect your computer to the monitor using a VGA cable.

Monitor Specifications

The following sections give you information about the various power management modes and pin assignments for the various connectors of your monitor.

Power Management Modes

If you have VESA's DPM compliance display card or software installed in your PC, the monitor automatically reduces its power consumption when not in use. This is referred to as Power Save Mode. If the computer detects input from keyboard, mouse, or other input devices, the monitor automatically resumes functioning. The following table shows the power consumption and signaling of this automatic power-saving feature:

E2015HV:

VESA Modes	Horizontal Sync	Vertical Sync	Video	Power Indicator	Power Consumption
Normal operation	Active	Active	Active	White	20 W (Maximum)** 16 W (Typical)
Active-off mode	Inactive	Inactive	Blank	Glowing white	Less than 0.5 W
Switch off	-	-		Off	Less than 0.5 W *

E2215HV:

VESA Modes	Horizontal Sync	Vertical Sync	Video	Power Indicator	Power Consumption
Normal operation	Active	Active	Active	White	25 W (Maximum)** 18.5 W (Typical)
Active-off mode	Inactive	Inactive	Blank	Glowing white	Less than 0.5 W
Switch off	-	-		Off	Less than 0.5 W *

E2715H:

VESA Modes	Horizontal Sync	Vertical Sync	Video	Power Indicator	Power Consumption
Normal operation	Active	Active	Active	White	31 W (Maximum)** 25 W (Typical)
Active-off mode	Inactive	Inactive	Blank	Glowing white	Less than 0.5 W
Switch off	-	-		Off	Less than 0.5 W *

The OSD will only function in the *normal operation* mode. When any button except power button is pressed in Active-off mode, the following messages will be displayed:

Dell E2015HV / E2215HV

There is no signal coming from your computer. Press any key on the keyboard or move the mouse to wake it up.

E2715H

There is no signal coming from your computer. Press any key on the keyboard or move the mouse to wake it up. If there is no display, press the monitor button now to select the correct input source on the On-Screen-Display menu.

Activate the computer and monitor to gain access to the **OSD**.



NOTE: The Dell E2015HV/E2215HV/E2715H monitor is ENERGY STAR®-compliant.



* Zero-power consumption in OFF mode can only be achieved by disconnecting the main cable from the monitor.

** Maximum power consumption with max luminance and contrast.

Pin Assignments

15-pin D-Sub connector

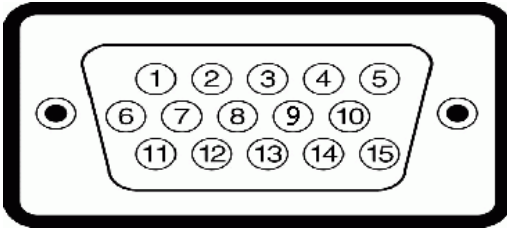

Pin Number	Monitor Side of the 15-pin Side Signal Cable
1	Video-Red
2	Video-Green
3	Video-Blue
4	GND
5	Self-test
6	GND-R
7	GND-G
8	GND-B
9	DDC +5 V
10	GND-sync
11	GND
12	DDC data
13	H-sync
14	V-sync
15	DDC clock

DVI Connector

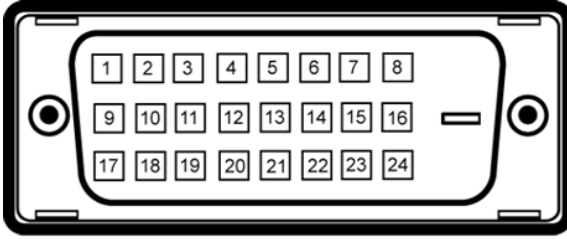

Pin Number	24-pin Side of the Connected Signal Cable
1	TMDS RX2-
2	TMDS RX2+
3	TMDS Ground
4	Floating
5	Floating
6	DDC Clock
7	DDC Data
8	Floating
9	TMDS RX1-
10	TMDS RX1+
11	TMDS Ground
12	Floating
13	Floating
14	+5 V power
15	Self test
16	Hot Plug Detect
17	TMDS RX0-
18	TMDS RX0+
19	TMDS Ground
20	Floating
21	Floating
22	TMDS Ground
23	TMDS Clock+
24	TMDS Clock-

DisplayPort connector

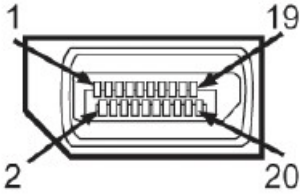

Pin Number	20-pin Side of the Connected Signal Cable
1	ML0(p)
2	GND
3	ML0(n)
4	ML1(p)
5	GND
6	ML1(n)
7	ML2(p)
8	GND
9	ML2(n)
10	ML3(p)
11	GND
12	ML3(n)
13	GND
14	GND
15	AUX(p)
16	GND
17	AUX(n)
18	HPD
19	DP_PWR_Return
20	+3.3 V DP_PWR

Plug and Play Capability

You can install the monitor in any Plug and Play compatible system. The monitor automatically provides the computer with its Extended Display Identification Data (EDID) using Display Data Channel (DDC) protocols so that the system can configure itself and optimize the monitor settings. Most monitor installations are automatic. You can select different settings if required.

Flat-Panel Specifications

Model number	E2015HV	E2215HV	E2715H
Screen type	Active matrix - TFT LCD	Active matrix - TFT LCD	Active matrix - TFT LCD
Panel Type	TN	TN	IPS / PLS
Viewable image			
Diagonal	495.3 mm (19.50 inches)	546.9 mm (21.53 inches)	685.8 mm (27.00 inches)
Horizontal Active Area	432.0 ± 1.92 mm (17.0 ± 0.08 inches)	476.64 mm (18.77 inches)	597.9 mm (23.54 inches)
Vertical Active Area	239.76 ± 3.42 mm (9.44 ± 0.13 inches)	268.11 mm (10.56 inches)	336.3 mm (13.24 inches)
Area	103576.3 ± 6.57 mm ² (160.57 ± 0.01 inches ²)	146168.58 mm ² (198.21 inches ²)	201073.77 mm ² (311.67 inches ²)
Pixel pitch	0.2712 x 0.2626 ± 0.0074 mm	0.2483 x 0.2483 mm	0.3114 x 0.3114 mm
Viewing angle:			
Horizontal	90° typical	90° typical	178° typical
Vertical	50° to 65° typical	50° to 65° typical	178° typical
Luminance output	200 cd/m ² (typical)	200 cd/m ² (typical)	300 cd/m ² (typical)
Contrast ratio	600 to 1 (typical)	600 to 1 (typical)	1000 to 1 (typical)
Faceplate coating	Antiglare with hard-coating 3H	Antiglare with hard-coating 3H	Antiglare with hard-coating 3H
Backlight	LED light bar system	LED light bar system	LED light bar system
Response Time	5 ms typical (black to white)	5 ms typical (black to white)	8 ms typical (grey to grey)

Color Depth	16.7 mil colors	16.7 mil colors	16.7 mil colors
Color Gamut	85 % (typical) **	85 % (typical) **	85 % (typical) **

** E2015HV/E2215HV/E2715H color gamut (typical) is based on CIE1976 (85 %) and CIE1931 (72 %) test standards.

Resolution Specifications

Model number	E2015HV	E2215HV/E2715H
Scan range	<ul style="list-style-type: none"> Horizontal 30 kHz to 83 kHz (automatic) Vertical 56 Hz to 76 Hz (automatic) 	
Maximum preset resolution	1600 x 900 at 60 Hz	1920 x 1080 at 60 Hz

Electrical Specifications

Model number	E2015HV/E2215HV	E2715H
Video input signals	Analog RGB: 0.7 Volts \pm 5 %, 75 ohm input impedance	<ul style="list-style-type: none"> Analog RGB: 0.7 Volts \pm 5 %, 75 ohm input impedance Digital DVI-D TMD5, 600 mV for each differential line, positive polarity at 50 ohm input impedance DisplayPort*, 600mV for each differential line, 100 ohm input impedance per differential pair
Synchronization input signals	Separate horizontal and vertical synchronizations, polarity-free TTL level, SOG (Composite SYNC on green)	
AC input voltage / frequency / current	100 VAC to 240 VAC / 50 Hz or 60 Hz \pm 3 Hz / 1.5 A (typical)	
Inrush current	120 V: 30 A (Max.) 240 V: 60 A (Max.)	

*Supports DP 1.2 (CORE) specification. Excludes Fast AUX transaction, 3D stereo transport , HBR Audio (or high data rate audio).

Preset Display Modes

The following table lists the preset modes for which Dell guarantees image size and centering:

E2015HV :

Display Mode	Horizontal Frequency (kHz)	Vertical Frequency (Hz)	Pixel Clock (MHz)	Sync Polarity (Horizontal/Vertical)
VESA, 720 x 400	31.5	70.1	28.3	-/+
VESA, 640 x 480	31.5	59.9	25.2	-/-
VESA, 640 x 480	37.5	75.0	31.5	-/-
VESA, 800 x 600	37.9	60.3	40.0	+/+
VESA, 800 x 600	46.9	75.0	49.5	+/+
VESA, 1024 x 768	48.4	60.0	65.0	-/-
VESA, 1024 x 768	60.0	75.0	78.8	+/+
VESA, 1152 x 864	67.5	75.0	108.0	+/+
VESA, 1280 x 1024	64.0	60.0	108.0	+/+
VESA, 1280 x 1024	80.0	75.0	135.0	+/+
VESA, 1600 x 900	55.5	60.0	97.8	+/-

E2215HV/E2715H :

Display Mode	Horizontal Frequency (kHz)	Vertical Frequency (Hz)	Pixel Clock (MHz)	Sync Polarity (Horizontal/Vertical)
VESA, 720 x 400	31.5	70.1	28.3	-/+
VESA, 640 x 480	31.5	59.9	25.2	-/-
VESA, 640 x 480	37.5	75.0	31.5	-/-
VESA, 800 x 600	37.9	60.3	40.0	+/+
VESA, 800 x 600	46.9	75.0	49.5	+/+
VESA, 1024 x 768	48.4	60.0	65.0	-/-
VESA, 1024 x 768	60.0	75.0	78.8	+/+
VESA, 1152 x 864	67.5	75.0	108.0	+/+
VESA, 1280 x 1024	64.0	60.0	108.0	+/+
VESA, 1280 x 1024	80.0	75.0	135.0	+/+
VESA, 1600 x 900	60.0	60.0	108.0	+/+
VESA, 1920 x 1080	67.5	60.0	148.5	+/+

Physical Characteristics

The following table lists the monitor's physical characteristics:

Model Number	E2015HV	E2215HV	E2715H
Connector type	15-pin D-subminiature (Blue connector)		15-pin D-subminiature (Blue connector); DVI-D: white connector; DP: Black connector
Signal cable type	VGA		VGA DVI-D DisplayPort
Dimensions: (with stand)			
Height	358.8 mm (14.12 inches)	395.8 mm (15.59 inches)	459.0 mm (18.07 inches)
Width	473.9 mm (typical), 468.6 mm (minimum) (18.66 inches (typical), 18.45 inches (minimum))	513.2 mm (20.21 inches)	641.5 mm (25.26 inches)
Depth	165.5 mm (6.52 inches)	165.5 mm (6.52 inches)	180.0 mm (7.09 inches)
Dimensions: (without stand)			
Height	276.3 mm (10.88 inches)	304.7 mm (12.00 inches)	379.9 mm (14.96 inches)
Width	473.9 mm (typical), 468.6 mm (minimum) (18.66 inches (typical), 18.45 inches (minimum))	513.2 mm (20.21 inches)	641.5 mm (25.26 inches)
Depth	46.5 mm (1.83 inches)	46.5 mm (1.83 inches)	46.5 mm (1.83 inches)

Stand dimensions:			
Height	149.0 mm (5.87 inches)	171.9 mm (6.77 inches)	339.1 mm (13.35 inches)
Width	180.6 mm (7.11 inches)	180.5 mm (7.11 inches)	220.0 mm (8.66 inches)
Depth	165.5 mm (6.52 inches)	165.5 mm (6.52 inches)	180.0 mm (7.09 inches)
Weight:			
Weight with packaging	3.65 kg (8.03 lb)	4.25 kg (9.35 lb)	8.55 kg (18.81 lb)
Weight with stand assembly and cables	3.00 kg (6.60 lb)	3.50 kg (7.70 lb)	6.15 kg (13.53 lb)
Weight without stand assembly (For wall mount or VESA mount considerations - no cables)	2.38 kg (5.24 lb)	2.90 kg (6.38 lb)	4.53 kg (9.97 lb)
Weight of stand assembly	0.33 kg (0.73 lb)	0.40 kg (0.88 lb)	1.19 kg (2.62 lb)

Environmental Characteristics

The following table lists the environmental conditions for your monitor:

Model Number	E2015HV	E2215HV	E2715H
Temperature <ul style="list-style-type: none"> Operating Non-operating 	0 °C to 40 °C (32 °F to 104 °F) Storage: -20 °C to 60 °C (-4 °F to 140 °F) Shipping: -20 °C to 60 °C (-4 °F to 140 °F)		
Humidity <ul style="list-style-type: none"> Operating Non-operating 	10 % to 80 % (non-condensing) Storage: 5 % to 90 % (non-condensing) Shipping: 5 % to 90 % (non-condensing)		
Altitude <ul style="list-style-type: none"> Operating Non-operating 	5,000 m (16,404 ft) max 12,191 m (40,000 ft) max		
Thermal dissipation	68.3 BTU/hour (maximum) 54.6 BTU/hour (typical)	85.3 BTU/hour (maximum) 63.1 BTU/hour (typical)	105.8 BTU/hour (maximum) 85.3 BTU/hour (typical)

LCD Monitor Quality & Pixel Policy



During the LCD Monitor manufacturing process, it is not uncommon for one or more pixels to become fixed in an unchanging state. The visible result is a fixed pixel that appears as an extremely tiny dark or bright discolored spot. When the pixel remains permanently lit, it is known as a "bright dot." When the pixel remains black, it is known as a "dark dot."

In almost every case, these fixed pixels are hard to see and do not detract from display quality or usability. A display with 1 to 5 fixed pixels is considered normal and within competitive standards. For more information, see Dell Support site at:

<http://www.dell.com/support/monitors>.

Maintenance Guidelines

Caring for Your Monitor

-  **CAUTION: Read and follow the safety instructions before cleaning the monitor.**
-  **CAUTION: Before cleaning the monitor, unplug the monitor power cable from the electrical outlet.**

For best practices, follow the instructions in the list below while unpacking, cleaning, or handling your monitor:

- To clean your antistatic screen, slightly dampen a soft, clean cloth with water. If possible, use a special screen-cleaning tissue or solution suitable for the antistatic coating. Do not use benzene, thinner, ammonia, abrasive cleaners, or compressed air.
- Use a slightly dampened, warm cloth to clean the plastics. Avoid using detergent of any kind as some detergents leave a milky film on the plastics.
- If you notice a white powder when you unpack your monitor, wipe it off with a cloth. This white powder occurs during the shipping of the monitor.
- Handle your monitor with care as a darker-colored monitor may scratch and show white scuff marks more than a lighter-colored monitor.
- To help maintain the best image quality on your monitor, use a dynamically changing screen saver and power off your monitor when not in use.

Setting Up the Monitor

Attaching the Stand

 **NOTE:** The stand base is detached when the monitor is shipped from the factory.

1. Assemble the stand riser to stand base.

E2015HV:

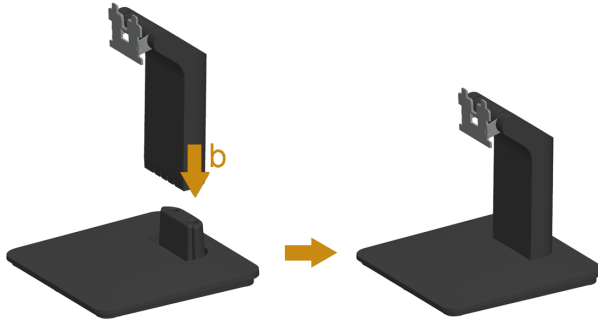

E2215HV:

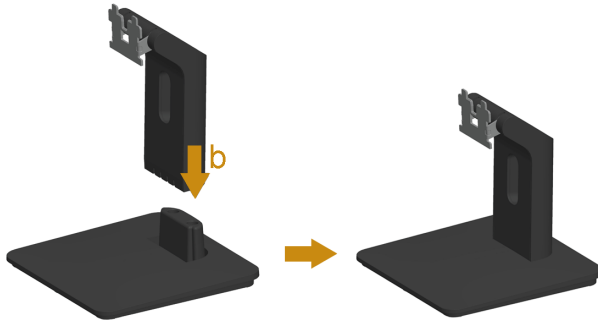

E2715H:

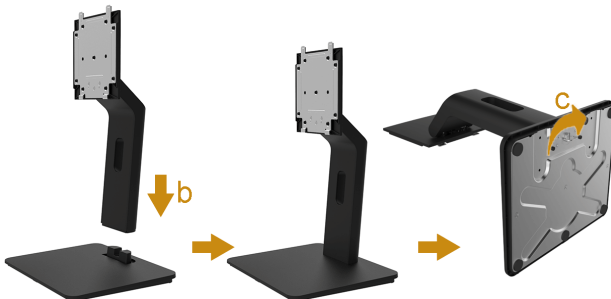

- a. Place the monitor stand base on a stable table top.
 - b. Slide the monitor stand body in the correct direction down onto the stand base until it clicks into place.
 - c. Tighten the screw located on the base.
2. Attach the stand assembly to the monitor:

E2015HV/E2215HV:



- a. Place the monitor on a soft cloth or cushion near the edge of desk.
- b. Align the stand assembly bracket to the monitor groove.
- c. Insert the bracket towards monitor until it locks in place.

E2715H:



- a. Remove the cover and place the monitor on a flat surface.
- b. Fit the two tabs on the upper part of the stand to the groove on the back of the monitor.
- c. Press the stand till it snaps into place.

Connecting Your Monitor

⚠ WARNING: Before you begin any of the procedures in this section, follow the **Safety Instructions**.

To connect your monitor to the computer:

1. Turn off your computer and disconnect the power cable.
2. Connect the white (digital DVI-D) or the blue (analog VGA) or the black (DisplayPort) display connector cable to the corresponding video port on the back of your computer. Do not use three cables at the same time. Use three the cables only when they are connected to three different computers with appropriate video systems.

Connecting the blue VGA Cable

E2015HV:



E2215HV:



E2715H:



Connecting the white DVI cable (for E2715H only)



Connecting the black DP cable (for E2715H only)



 **Note:** The graphics are used for the purpose of illustration only. Appearance on the computer may vary.

Organizing Your Cables (for E2215HV / E2715H)

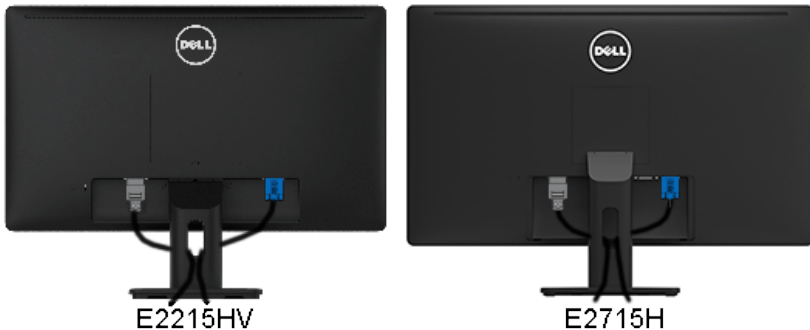

After attaching all necessary cables to your monitor and computer, (See Connecting Your Monitor for cable attachment), organize all cables as shown above.

Attaching the Cable Cover (for only E2715H)



NOTE: The Cable Cover is detached when the monitor is shipped from the factory.



To attach the Cable Cover:

1. Fit the two tabs on the bottom part of the Cable Cover to the groove on the back of the monitor.
2. Press the Cable Cover till it snaps into place.

Removing the Monitor Stand



Note: This is applicable for a monitor with a stand. When any other stand is bought, please refer to the respective stand setup guide for the removal instructions.

After placing the monitor panel on a soft cloth or cushion, complete the following steps to remove the base:

E2015HV:



E2215HV:



1. Use a long screwdriver to push the release latch located in a hole just above the stand.
2. Once the latch is released, remove the base away from the monitor.

E2715H:



1. Press and hold the stand-release button.
2. Lift the stand up and away from the monitor.

Wall Mounting (Optional)

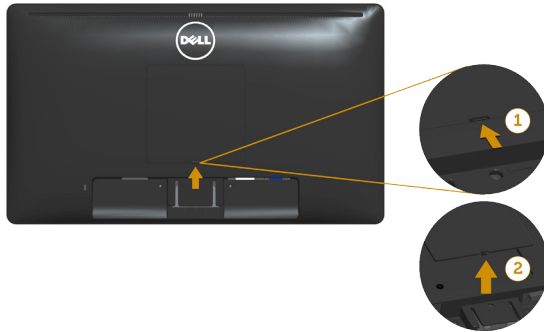

figure 1

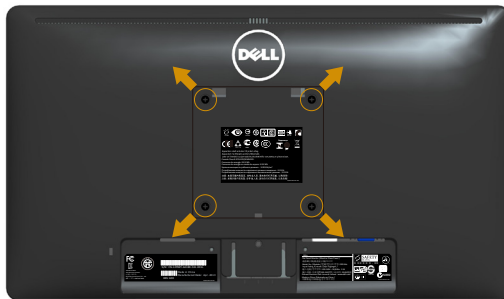



figure 2

(Screw dimension: M4 x 10 mm). Refer to the instructions that come with the VESA-compatible base mounting kit.

1. Place the monitor panel on a soft cloth or cushion on a stable flat table.
2. Remove the stand.
3. Remove the VESA Screw Cover (figure 1)
4. Use a screwdriver to remove the four screws securing the plastic cover. (figure 2)
5. Attach the mounting bracket from the wall mounting kit to the LCD.
6. Mount the LCD on the wall by following the instructions that came with the base mounting kit.

 **NOTE:** For use only with UL-listed wall-mount bracket with minimum weight/load bearing capacity of 2.38 kg (E2015HV)/2.90kg (E2215HV)/4.53 kg (E2715H)

Operating the Monitor

Power On the Monitor

Press the  button to turn on the monitor.

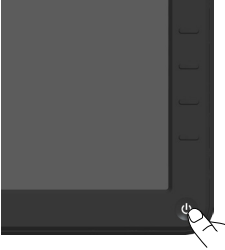



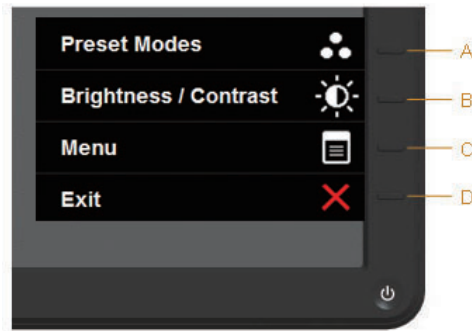

Using the Front-Panel Controls

Use the keys on the front of the monitor to adjust the image settings.





E2015HV/E2215HV:

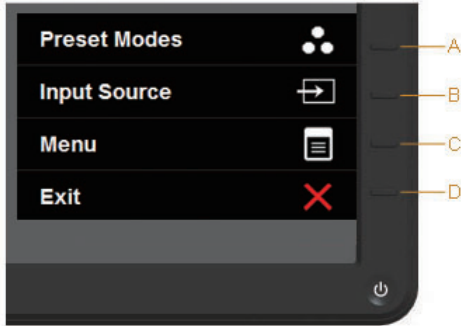

Front-Panel Keys		Description
A	 Preset modes	Use the Preset modes key to choose from a list of preset color modes. See Using the OSD Menu .
B	 Brightness / Contrast	Use the Brightness / Contrast key to direct access to the "Brightness" and "Contrast" control menu.
C	 Menu	Use the Menu key to open the on-screen display (OSD).
D	 Exit	Use the Exit key to exit on-screen display (OSD) from menu and sub-menus.





E2715H:



Front-Panel Keys		Description
A	 Preset modes	Use the Preset modes key to choose from a list of preset color modes. See Using the OSD Menu .
B	 Input Source	Use the Input Source key to select between different video signals that may be connected to your monitor. <ul style="list-style-type: none">• VGA input• DVI-D input• Displayport input
C	 Menu	Use the Menu key to open the on-screen display (OSD).
D	 Exit	Use the Exit key to exit on-screen display (OSD) from menu and sub-menus.

Front-Panel Keys



Front-Panel Keys		Description
A	 Up	Use the Up key to adjust (increase ranges) items in the OSD menu.
B	 Down	Use the Down key to adjust (decrease ranges) items in the OSD menu.
C	 OK	Use the OK key to confirm your selection.
D	 Back	Use the Back key to go back to the previous menu.

Using the On-Screen Display (OSD) Menu

Accessing the Menu System

 **NOTE:** If you change the settings and then either proceed to another menu or exit the OSD menu, the monitor automatically saves those changes. The changes are also saved if you change the settings and then wait for the OSD menu to disappear.

1. Press the  button to open the OSD menu and display the main menu.

Main Menu

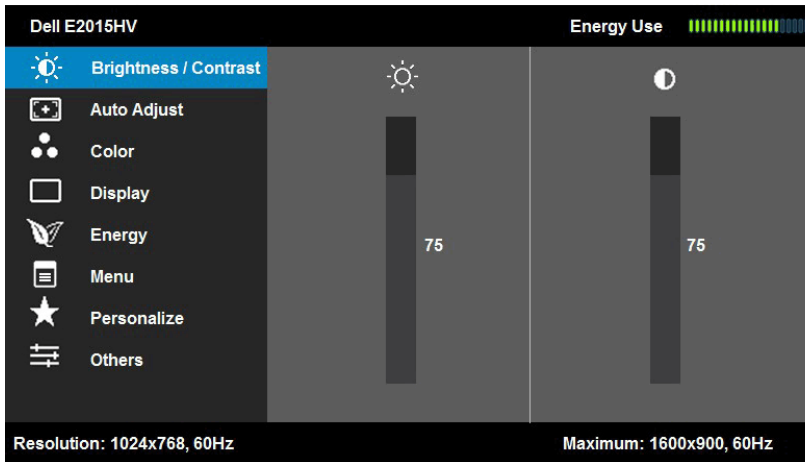

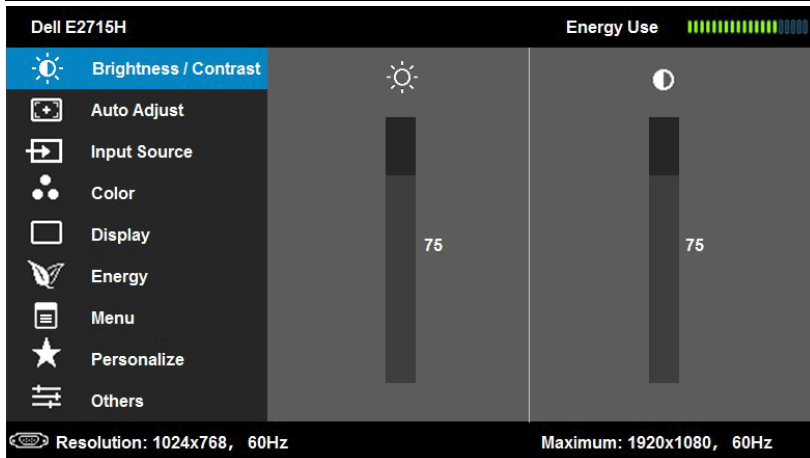
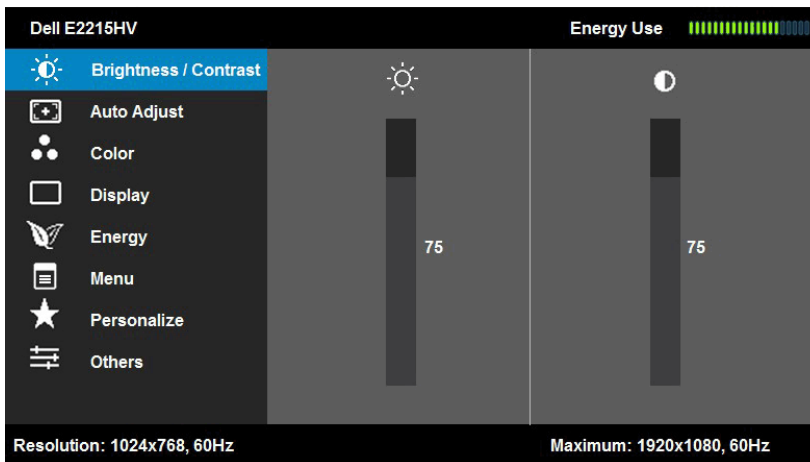





NOTE: Auto Adjust is only available when you use the analog (VGA) connector.

2. Press the and buttons to toggle between options in the Menu. As you move from one icon to another, the option name is highlighted.
3. To select the highlighted item on the menu press the button again.
4. Press the and buttons to select the desired parameter.
5. Press the button to enter the slide bar and then use the or buttons, according to the indicators on the menu, to make your changes.
6. Select the to return to previous menu without accepting current settings or to accept and return to previous menu.

The table below provides a list of all the OSD menu options and their functions.

Icon	Menu and Submenus	Description
	Energy Use	This meter shows the energy level being consumed by the monitor in real time.
	Brightness/ Contrast	Use the Brightness and Contrast menu to adjust the Brightness/Contrast.
<p>The screenshots illustrate the OSD menu for three monitor models:</p> <ul style="list-style-type: none"> Dell E2015HV: Shows the OSD menu with 'Brightness / Contrast' selected. The sliders for both are set to 75. The maximum resolution is 1600x900, 60Hz. Dell E2215HV: Shows the OSD menu with 'Brightness / Contrast' selected. The sliders for both are set to 75. The maximum resolution is 1920x1080, 60Hz. Dell E2715H: Shows the OSD menu with 'Brightness / Contrast' selected. The sliders for both are set to 75. The maximum resolution is 1920x1080, 60Hz. 		

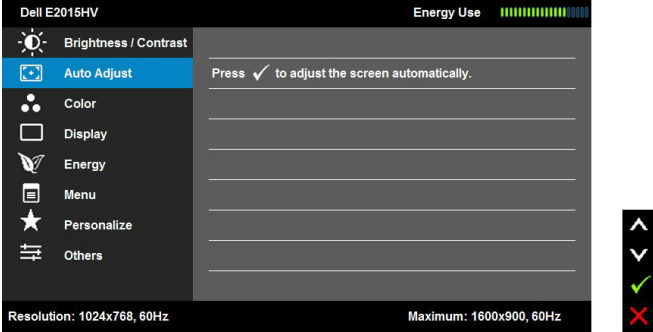
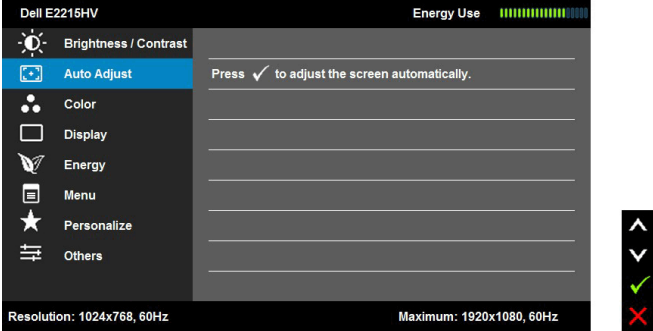
	Brightness	<p>Allows you to adjust the brightness or luminance of the backlight.</p> <p>Press the  key to increase brightness and press the  key to decrease brightness (min 0 ~ max 100).</p>
	Contrast	<p>Allows you to adjust the contrast or the degree of difference between darkness and lightness on the monitor screen. Adjust brightness first, and adjust contrast only if you need further adjustment.</p> <p>Press the  key to increase contrast and press the  key to decrease contrast (min 0 ~ max 100).</p>
	Auto Adjust	<p>Use this key to activate automatic setup and adjust menu.</p>  

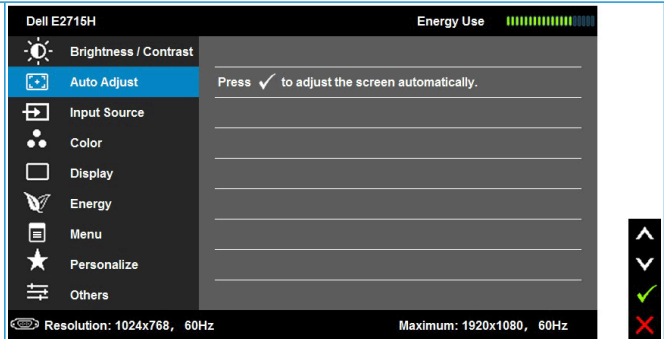

The following dialog appears on a black screen as the monitor self-adjusts to the current input:



Auto Adjustment allows the monitor to self-adjust to the incoming video signal. After using Auto Adjustment, you can further tune your monitor by using the Pixel Clock (Coarse) and Phase (Fine) controls under **Display**.

NOTE: Auto Adjust does not occur if you press the button while there are no active video input signals or attached cables.

This option is only available when you are using the analog (VGA) connector.



Input Source (for E2715H only)

Use the **Input Source** menu to select between different video signals that may be connected to your monitor.

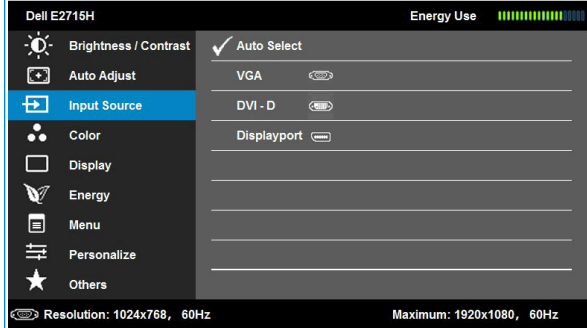

Auto Select

Select **Auto Select** to scan for available input signals.

VGA

Select **VGA** input when you are using the analog (VGA) connector. Push to select the VGA input source.

DVI-D

Select **DVI-D** input when you are using the Digital (DVI) connector. Push to select the DVI input source.

Displayport

Select **Displayport** input when you are using the DP connector. Push to select the DP input source.



Color

Use the **Color** menu to adjust the monitor's color settings.

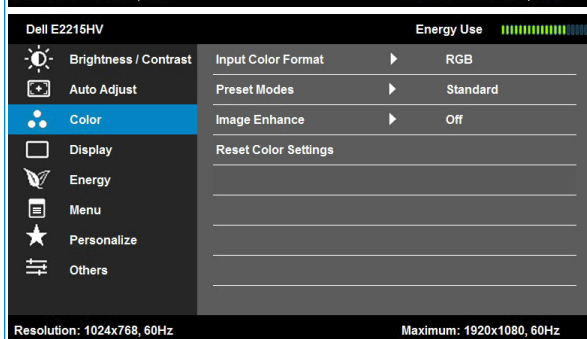
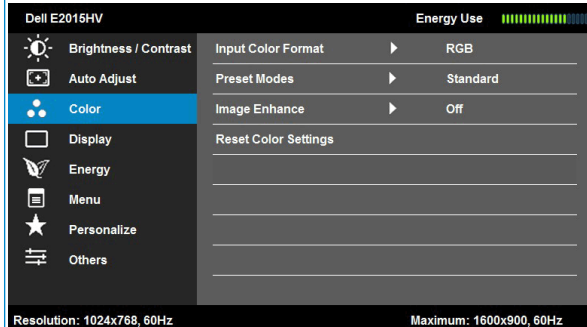

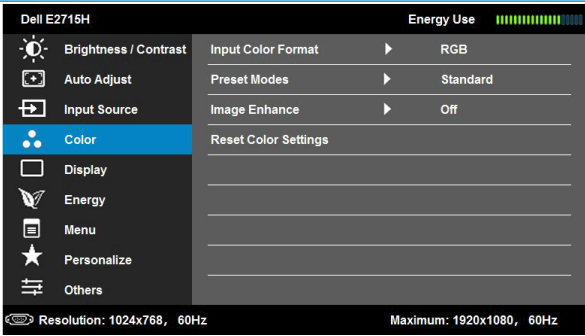
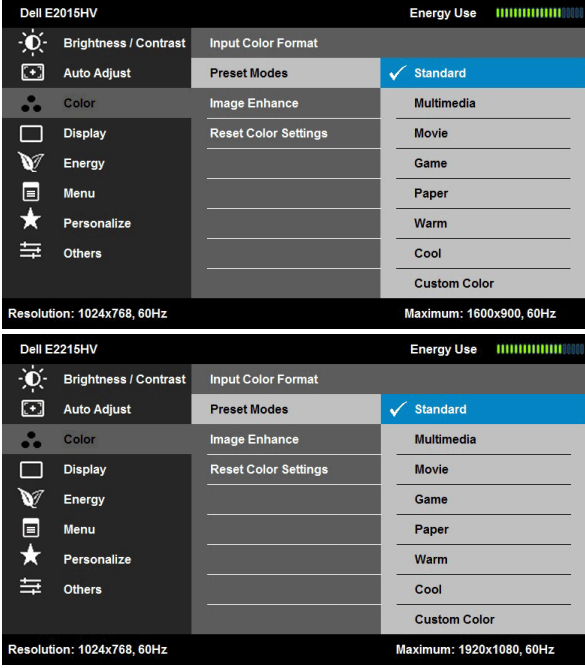
	
<p>Input Color Format</p>	<p>Allows you to set the video input mode to:</p> <ul style="list-style-type: none"> • RGB: Select this option if your monitor is connected to a computer or DVD player using the HDMI to DVI adapter. • YPbPr: Select this option if your DVD player supports only YPbPr output.
<p>Preset Modes</p>	<p>Allows you to choose from a list of preset color modes.</p> 

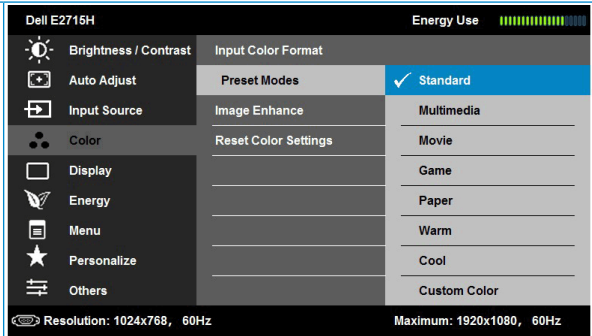

- **Standard:** Loads the monitor's default color settings. This is the default preset mode.
- **Multimedia:** Loads color settings ideal for multimedia applications.
- **Movie:** Loads color settings ideal for movies.
- **Game:** Loads color settings ideal for most gaming applications.
- **Paper:** Loads brightness and sharpness settings ideal for viewing text. Blend the text background to simulate paper media without affecting color images. Applies to RGB input format only.
- **Warm:** Increases the color temperature. The screen appears warmer with a red/yellow tint.
- **Cool:** Decreases the color temperature. The screen appears cooler with a blue tint.
- **Custom Color:** Allows you to manually adjust the color settings. Press the ▲ and ▼ keys to adjust the Red, Green, and Blue values and create your own preset color mode.





Hue







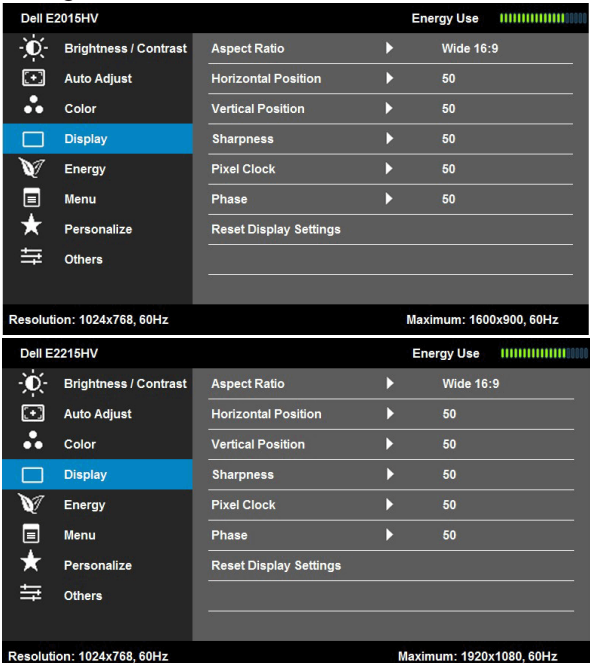

This feature can shift the color of the video image to green or purple. This is used to adjust the desired flesh tone color. Use ▲ or ▼ to adjust the hue from '0' to '100'.

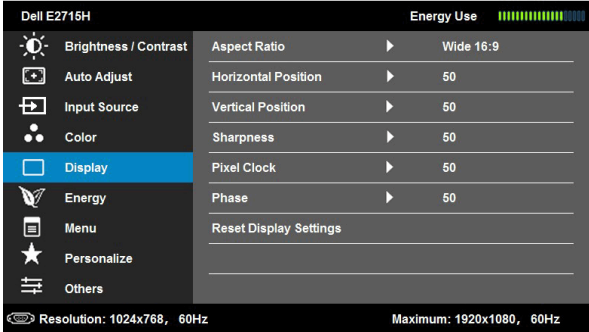
Press ▲ to increase the monochrome appearance of the video image.

Press ▼ to increase the colorful appearance of the video image.

NOTE: Hue adjustment is available only when you select **Movie** or **Game** preset mode.

<p>Saturation</p>	<p>This feature can adjust the color saturation of the video image. Use  or  to adjust the saturation from '0' to '100'.</p> <p>Press  to increase the monochrome appearance of the video image.</p> <p>Press  to increase the colorful appearance of the video image.</p> <p>NOTE: Saturation adjustment is available only when you select Movie or Game preset mode.</p>
<p>Image Enhance</p>	<p>Automatically sharpen images, enhance hues, boost color contrast and enhance image clarity.</p> <p>NOTE: Image Enhance is available only when you select Standard, Multimedia, Movie, or Game preset mode.</p>
<p>Reset Color Settings</p>	<p>Resets your monitor's color settings to the factory defaults.</p>
<p> Display</p>	<p>Use the Displays menu to adjust the monitor's display settings.</p>  <p>The screenshot shows two instances of the Dell OSD menu. The top instance is for the Dell E2015HV model, and the bottom instance is for the Dell E2215HV model. Both show the 'Display' menu selected, with settings for Aspect Ratio (Wide 16:9), Horizontal Position (50), Vertical Position (50), Sharpness (50), Pixel Clock (50), and Phase (50). The 'Reset Display Settings' option is also visible. The resolution and maximum resolution are shown at the bottom of each menu.</p>

	
Aspect Ratio	<p>Adjusts the image ratio as Wide 16:9, 4:3, or 5:4.</p> <p>NOTE: Wide 16:9 adjustment is not required at maximum preset resolution 1600 x 900 (for E2015HV) or 1920 x 1080 (for E2215HV/E2715H).</p>
Horizontal Position	<p>Use  or  the buttons to adjust image left and right. Minimum is '0' (-). Maximum is '100' (+).</p>
Vertical Position	<p>Use the  or  buttons to adjust image up and down. Minimum is '0' (-). Maximum is '100' (+).</p>
Sharpness	<p>This feature can make the image look sharper or softer. Use  or  to adjust the sharpness from '0' to '100'.</p>
Pixel Clock	<p>The Phase and Pixel Clock adjustments allow you to adjust your monitor to your preference. Use  or  buttons to adjust for best image quality.</p>
Phase	<p>If satisfactory results are not obtained using the Phase adjustment, use the Pixel Clock (coarse) adjustment and then use Phase (fine), again.</p> <p>NOTE: Pixel Clock and Phase adjustment are only available for VGA input.</p>
Reset Display Settings	<p>Select this option to restore default display settings.</p>



Menu

Select this option to adjust the settings of the OSD such as, the languages of the OSD, the amount of time the menu remains on screen, and so on.

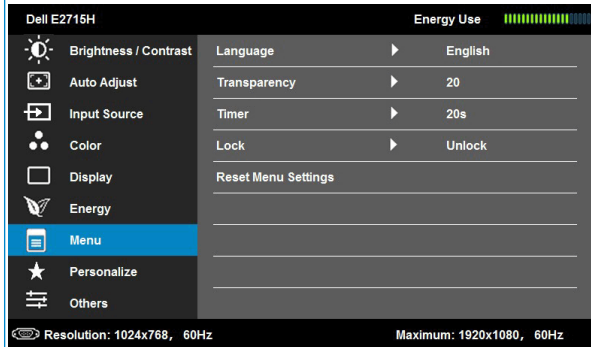
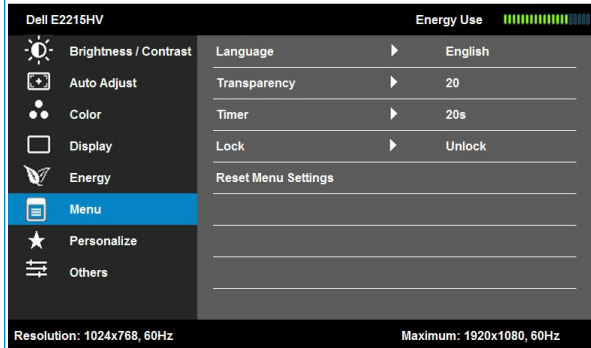
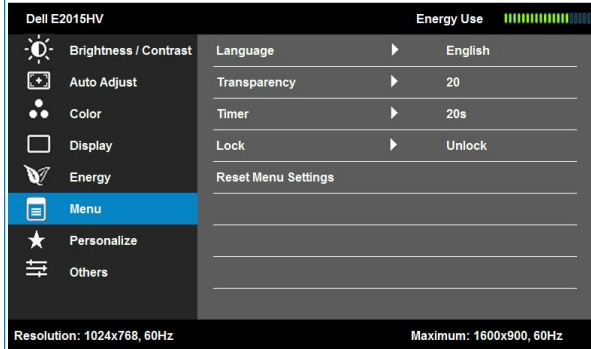





Language



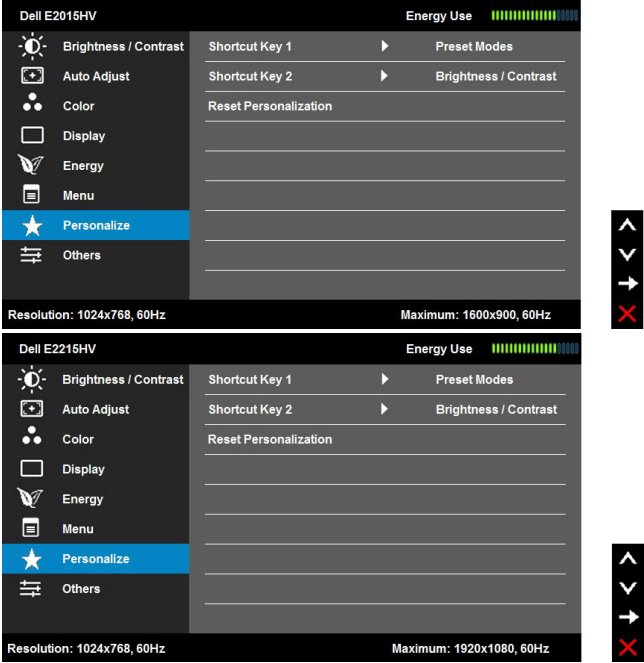

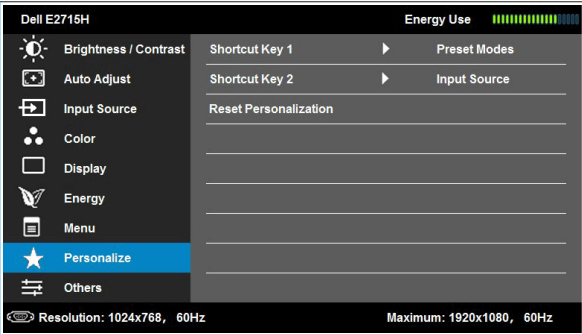
Allows you to set the OSD display to one of eight languages: English, Spanish, French, German, Brazilian Portuguese, Russian, Simplified Chinese, or Japanese.

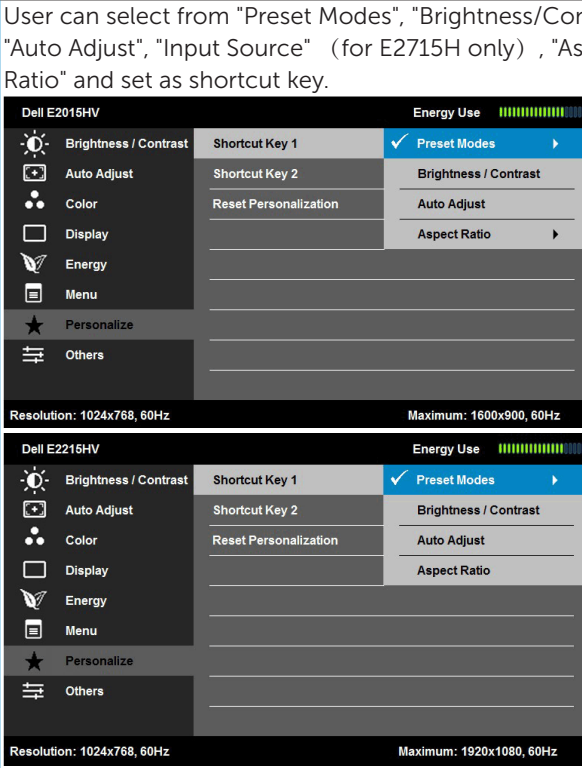

Transparency

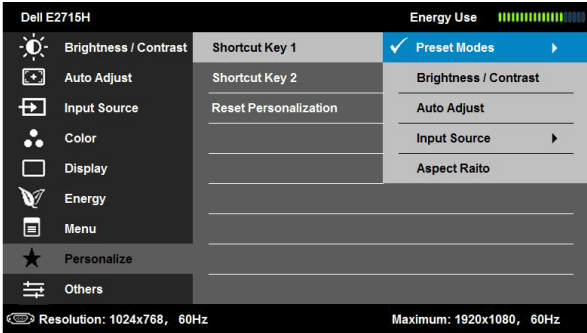
Allows you to adjust the OSD background from opaque to transparent.

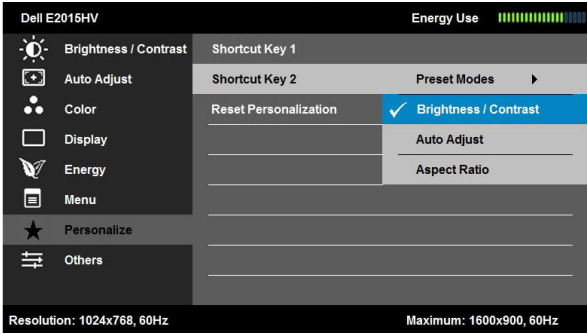
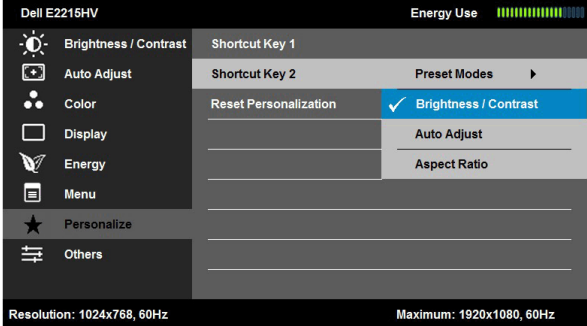
<p>Timer</p>	<p>Allows you to set the time for which the OSD remains active after you press a key on the monitor.</p> <p>Use the ▲ and ▼ keys to adjust the slider in 1 second increments, from 5 to 60 seconds.</p>
<p>Lock</p>	<p>Controls user access to adjustments. When Lock is selected, no user adjustments are allowed. All keys are locked except ⏻ key.</p> <p>NOTE: When the OSD is locked, pressing the menu key takes you directly to the OSD settings menu, with 'OSD Lock' pre-selected on entry. Press and hold ⏻ key for 10 seconds to unlock and allow user access to all applicable settings.</p>
<p>Reset Menu Settings</p>	<p>Select this option to restore default menu settings.</p>
<p>Personalize</p>	<p>Selecting this option allows you to set two shortcut keys.</p> 

		
<p>Shortcut Key 1</p>	<p>User can select from "Preset Modes", "Brightness/Contrast", "Auto Adjust", "Input Source" (for E2715H only), "Aspect Ratio" and set as shortcut key.</p> 	

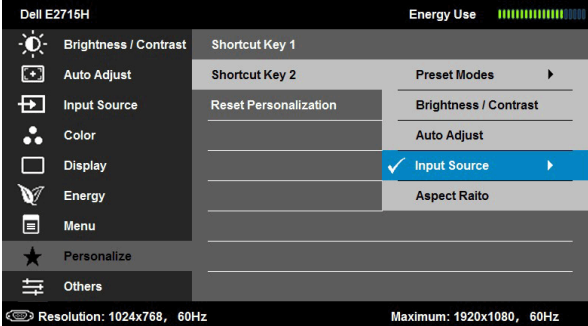
	 <p>Dell E2715H Energy Use [Progress Bar]</p> <ul style="list-style-type: none"> Brightness / Contrast: Shortcut Key 1 ✓ Preset Modes ▶ Auto Adjust: Shortcut Key 2 Brightness / Contrast Input Source: Reset Personalization Auto Adjust Color: Input Source ▶ Display: Aspect Ratio Energy Menu Personalize Others <p>Resolution: 1024x768, 60Hz Maximum: 1920x1080, 60Hz</p>	
<p>Shortcut Key 2</p>	<p>User can select from "Preset Modes", "Brightness/Contrast", "Auto Adjust", "Input Source" (for E2715H only) , "Aspect Ratio" and set as shortcut key.</p>  <p>Dell E2015HV Energy Use [Progress Bar]</p> <ul style="list-style-type: none"> Brightness / Contrast: Shortcut Key 1 Auto Adjust: Shortcut Key 2 Preset Modes ▶ Color: Reset Personalization ✓ Brightness / Contrast Display: Auto Adjust Energy: Aspect Ratio Menu Personalize Others <p>Resolution: 1024x768, 60Hz Maximum: 1600x900, 60Hz</p>  <p>Dell E2215HV Energy Use [Progress Bar]</p> <ul style="list-style-type: none"> Brightness / Contrast: Shortcut Key 1 Auto Adjust: Shortcut Key 2 Preset Modes ▶ Color: Reset Personalization ✓ Brightness / Contrast Display: Auto Adjust Energy: Aspect Ratio Menu Personalize Others <p>Resolution: 1024x768, 60Hz Maximum: 1920x1080, 60Hz</p>	

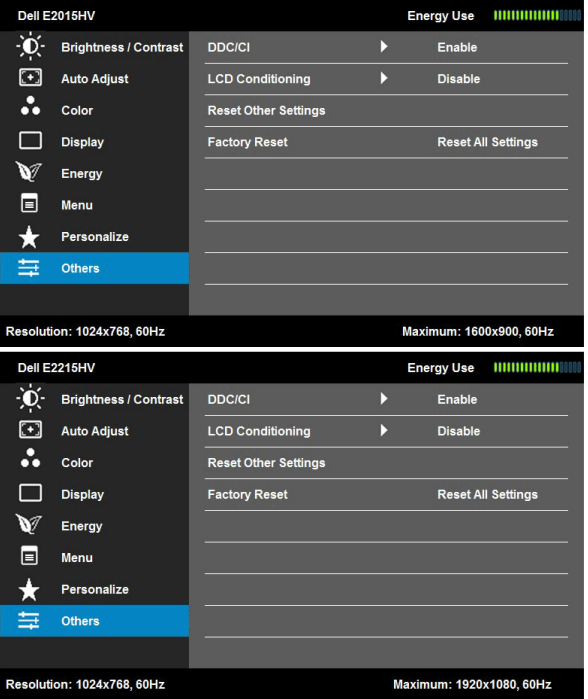
		 <p>Dell E2715H Energy Use [Progress Bar]</p> <ul style="list-style-type: none"> Brightness / Contrast Auto Adjust Input Source Color Display Energy Menu Personalize Others <p>Resolution: 1024x768, 60Hz Maximum: 1920x1080, 60Hz</p>
	<p>Reset Personalization</p>	<p>Allows you to restore shortcut key to the default setting.</p>
	<p>Other</p>	 <p>Dell E2015HV Energy Use [Progress Bar]</p> <ul style="list-style-type: none"> Brightness / Contrast Auto Adjust Color Display Energy Menu Personalize Others <p>Resolution: 1024x768, 60Hz Maximum: 1600x900, 60Hz</p> <p>Dell E2215HV Energy Use [Progress Bar]</p> <ul style="list-style-type: none"> Brightness / Contrast Auto Adjust Color Display Energy Menu Personalize Others <p>Resolution: 1024x768, 60Hz Maximum: 1920x1080, 60Hz</p>

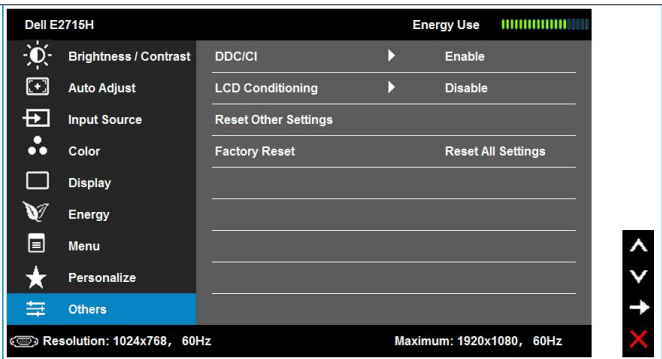
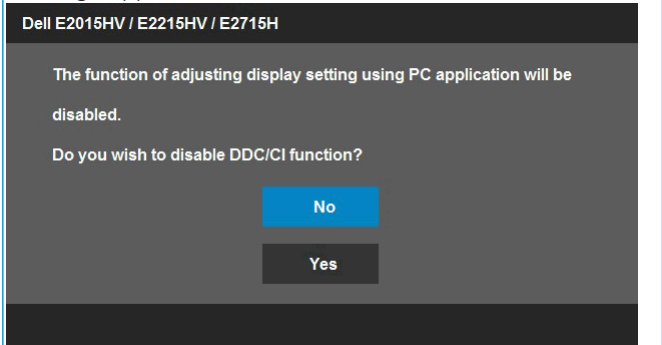
		
	<p>DDC/CI</p>	<p>DDC/CI (Display Data Channel/Command Interface) allows a software on your computer to adjust the monitor display settings like the brightness, color balance etc.</p> <p>Enable (Default): Optimizes the performance of your monitor and provides a better customer experience.</p> <p>Disable: Disables the DDC/CI option and the following message appears on the screen.</p> 

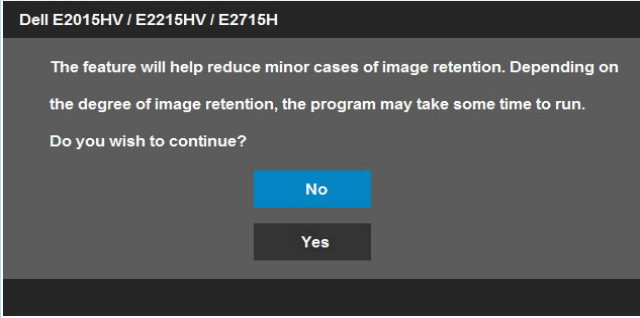
<p>LCD Conditioning</p>	<p>This feature will help reduce minor cases of image retention.</p> <p>If an image appears to be stuck on the monitor, select LCD Conditioning to help eliminate any image retention. Using the LCD Conditioning feature may take some time. LCD Conditioning feature cannot remove severe cases of image retention or burn-in.</p> <p>NOTE: Use LCD Conditioning only when you experience a problem with image retention.</p> <p>The below warning message appears once user selects "Enable" LCD Conditioning.</p>  <p>The screenshot shows a dark grey dialog box with the following text: "Dell E2015HV / E2215HV / E2715H", "The feature will help reduce minor cases of image retention. Depending on the degree of image retention, the program may take some time to run.", "Do you wish to continue?", and two buttons: "No" (highlighted in blue) and "Yes".</p>
<p>Reset Other Settings</p>	<p>Select this option to restore default other settings, such as DDC/CI.</p>
<p>Factory Reset</p>	<p>Resets all OSD settings to the factory preset values.</p>

OSD Messages

When the monitor does not support a particular resolution mode you will see the following message:

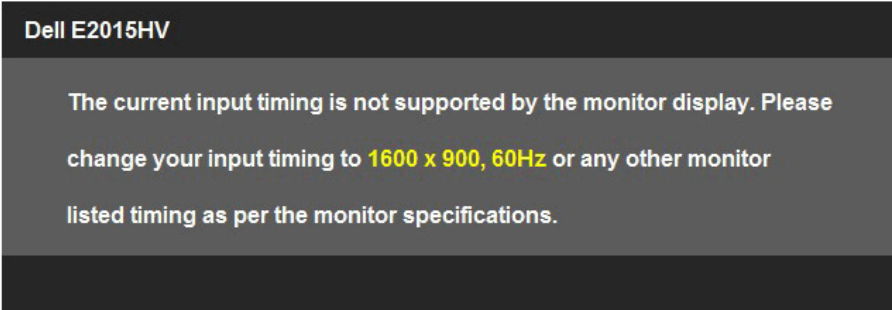

Dell E2215HV / E2715H

The current input timing is not supported by the monitor display. Please change your input timing to **1920 x 1080, 60Hz** or any other monitor listed timing as per the monitor specifications.

This means that the monitor cannot synchronize with the signal that it is receiving from the computer. See **Monitor Specifications** for the horizontal and vertical frequency ranges addressable by this monitor. Recommended mode is 1600 x 900 (for E2015HV) or 1920 x 1080 (for E2215HV/E2715H).

You will see the following message before the DDC/CI function is disabled.

Dell E2015HV / E2215HV / E2715H

The function of adjusting display setting using PC application will be disabled.

Do you wish to disable DDC/CI function?

No

Yes

When the monitor enters the **Power Save** mode, the following message appears:

Dell E2015HV / E2215HV / E2715H

Entering Power Save Mode.

Activate the computer and wake up the monitor to gain access to the **OSD**.

If you press any button other than the power button, the following messages will appear depending on the selected input:

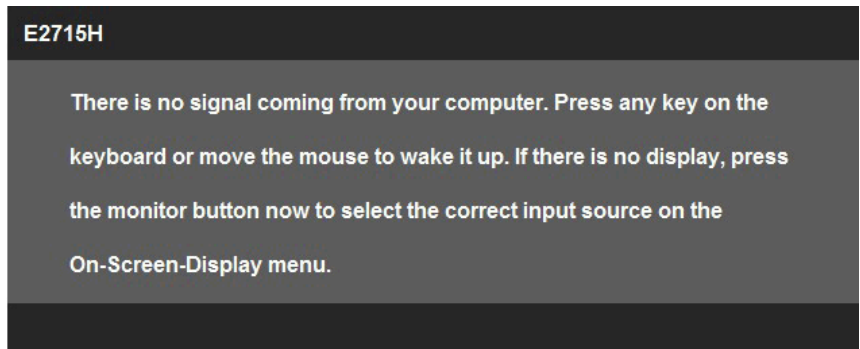
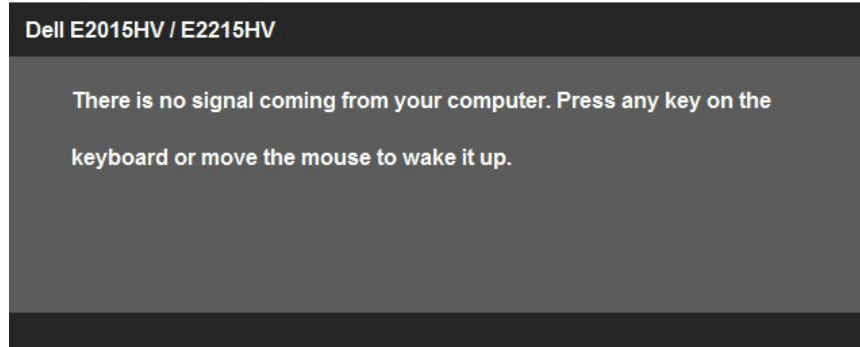

If VGA or DVI or DP cable is not connected, a floating dialog box as shown below appears. The monitor will enter **Power Save Mode after 5 minutes** if left at this state.

Dell E2015HV / E2215HV / E2715H



No VGA Cable

The display will go into Power Save Mode in 5 minutes

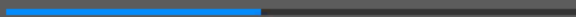

www.dell.com/support/monitors

Dell E2715H



No DVI-D Cable

The display will go into Power Save Mode in 5 minutes.



www.dell.com/support/monitors

Dell E2715H



No DisplayPort Cable

The display will go into Power Save Mode in 5 minutes.



www.dell.com/support/monitors

See [Solving Problems](#) for more information.

Setting the Maximum Resolution

Windows Vista® ,Windows® 7 ,Windows® 8 or Windows 8.1:

1. For Windows® 8 or Windows 8.1 only, select the Desktop tile to switch to classic desktop.
2. Right-click on the desktop and click **Screen Resolution**.
3. Click the dropdown list of the screen resolution and select 1600 x 900 (for E2015HV) or 1920 x 1080 (for E2215HV/E2715H).
4. Click OK.

If you do not see 1600 x 900 (for E2015HV) or 1920 x 1080 (for E2215HV/E2715H) as an option, you may need to update your graphics driver.

Depending on your computer, complete one of the following procedures:

If you have a Dell desktop or portable computer:

- Go to www.dell.com/support, enter your service tag, and download the latest driver for your graphics card.

If you are using a non-Dell computer (portable or desktop):

- Go to the support site for your computer and download the latest graphic drivers.
- Go to your graphics card website and download the latest graphic drivers.

Using the Tilt

Tilt

With the stand assembly, you can tilt the monitor for the most comfortable viewing angle.

E2015HV/E2215HV:

21° typical (maximum 22°) 5° typical (maximum 5.5°) 21° typical (maximum 22°) 5° typical (maximum 5.5°)



E2015HV



E2215HV

E2715H:

21° typical (maximum 22°) 5° typical (maximum 5.5°)



NOTE: The stand base is detached when the monitor is shipped from the factory.

Troubleshooting

 **WARNING:** Before you begin any of the procedures in this section, follow the [Safety Instruction](#)

Self-Test

Your monitor provides a self-test feature that allows you to check whether your monitor is functioning properly. If your monitor and computer are properly connected but the monitor screen remains dark, run the monitor self-test by performing the following steps:

1. Turn off both your computer and the monitor.
2. Unplug the video cable from the back of the computer. To ensure proper Self-Test operation, remove both Digital (white VGA / black DP connector) and the Analog (blue connector) cables from the back of computer.
3. Turn on the monitor.

The floating dialog box should appear on-screen (against a black background) if the monitor cannot sense a video signal and is working correctly. While in self-test mode, the power LED remains white. Also, depending upon the selected input, one of the dialogs shown below will continuously scroll through the screen.

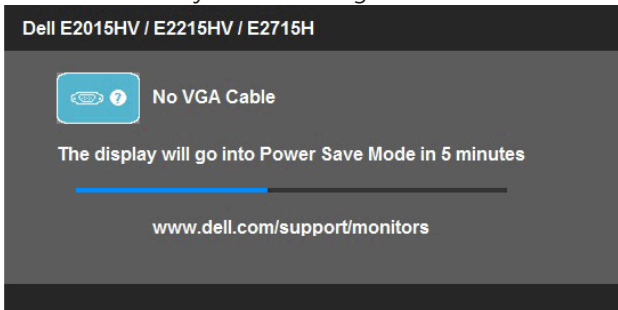

4. This box also appears during normal system operation, if the video cable becomes disconnected or damaged. The monitor will enter **Power Save Mode after 5 minutes** if left at this state.
5. Turn off your monitor and reconnect the video cable; then turn on both your computer and the monitor.

If your monitor screen remains blank after you use the previous procedure, check your video controller and computer, because your monitor is functioning properly.

 **NOTE:** Self-test feature check is not available for S-Video, Composite, and Component video modes.

Built-in Diagnostics

Your monitor has a built-in diagnostic tool that helps you determine if the screen abnormality you are experiencing is an inherent problem with your monitor, or with your computer and video card.

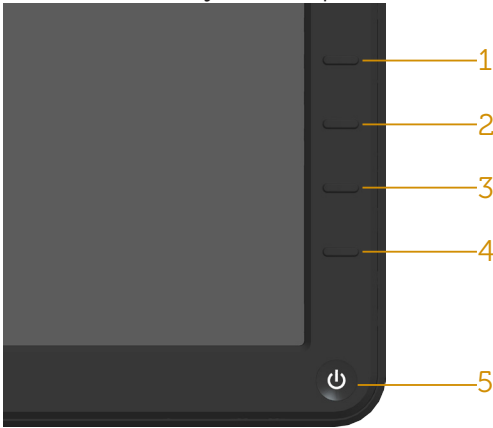

 **NOTE:** You can run the built-in diagnostics only when the video cable is unplugged and the monitor is in self-test mode.

To run the built-in diagnostics:

1. Ensure that the screen is clean (no dust particles on the surface of the screen).
2. Unplug the video cable(s) from the back of the computer or monitor. The monitor then goes into the self-test mode.
3. Press and hold the **Button 1** and **Button 4** on the front panel simultaneously for 2 seconds. A gray screen appears.
4. Carefully inspect the screen for abnormalities.
5. Press the **Button 4** on the front panel again. The color of the screen changes to red.
6. Inspect the display for any abnormalities.
7. Repeat steps 5 and 6 to inspect the display in green, blue, black, white screens.

The test is complete when the white screen appears. To exit, press the **Button 4** again.

If you do not detect any screen abnormalities upon using the built-in diagnostic tool, the monitor is functioning properly. Check the video card and computer.

Common Problems

The following table contains general information about common monitor problems you might encounter and the possible solutions.

Common Symptoms	What You Experience	Possible Solutions
No Video/Power LED off	No picture	<ul style="list-style-type: none"> • Ensure that the video cable connecting the monitor and the computer is properly connected and secure. • Verify that the power outlet is functioning properly using any other electrical equipment. • Ensure that the power button is depressed fully. • Ensure that the correct input source is selected via the Input Source Select button. • Check the “Power LED Button” option under Energy in OSD Menu.
No Video/Power LED on	No picture or no brightness	<ul style="list-style-type: none"> • Increase brightness & contrast controls via OSD. • Perform monitor self-test feature check. • Check for bent or broken pins in the video cable connector. • Ensure that the correct input source is selected via the Input Source Select menu. • Run the built-in diagnostics.
Poor Focus	Picture is fuzzy, blurry, or ghosting	<ul style="list-style-type: none"> • Perform Auto Adjust via OSD. • Adjust the Phase and Pixel Clock controls via OSD. • Eliminate video extension cables. • Reset the monitor to Factory Settings. • Change the video resolution to the correct aspect ratio (16:9).
Shaky/Jittery Video	Wavy picture or fine movement	<ul style="list-style-type: none"> • Perform Auto Adjust via OSD. • Adjust the Phase and Pixel Clock controls via OSD. • Reset the monitor to Factory Settings. • Check environmental factors. • Relocate the monitor and test in another room.

Missing Pixels	LCD screen has spots	<ul style="list-style-type: none"> • Cycle power on-off. • Pixel that is permanently off is a natural defect that can occur in LCD technology. <p>For more information on Dell Monitor Quality and Pixel Policy, see Dell Support site at: http://www.dell.com/support/monitors.</p>
Stuck-on Pixels	LCD screen has bright spots	<ul style="list-style-type: none"> • Cycle power on-off. • Pixel that is permanently off is a natural defect that can occur in LCD technology. <p>For more information on Dell Monitor Quality and Pixel Policy, see Dell Support site at: http://www.dell.com/support/monitors.</p>
Brightness Problems	Picture too dim or too bright	<ul style="list-style-type: none"> • Reset the monitor to Factory Settings. • Auto Adjust via OSD. • Adjust brightness & contrast controls via OSD.
Geometric Distortion	Screen not centered correctly	<ul style="list-style-type: none"> • Reset the monitor to Factory Settings. • Auto Adjust via OSD. • Adjust brightness & contrast controls via OSD. <p>NOTE: When using 'DVI-D / DP', the positioning adjustments are not available.</p>
Horizontal/Vertical Lines	Screen has one or more lines	<ul style="list-style-type: none"> • Reset the monitor to Factory Settings. • Perform Auto Adjust via OSD. • Adjust Phase and Pixel Clock controls via OSD. • Perform monitor self-test feature check and determine if these lines are also in self-test mode. • Check for bent or broken pins in the video cable connector. <p>NOTE: When using 'DVI-D / DP', the Pixel Clock and Phase adjustments are not available.</p>

Synchronization Problems	Screen is scrambled or appears torn	<ul style="list-style-type: none"> • Reset the monitor to Factory Settings. • Perform Auto Adjust via OSD. • Adjust Phase and Pixel Clock controls via OSD. • Perform monitor self-test feature check to determine if the scrambled screen appears in self-test mode. • Check for bent or broken pins in the video cable connector. • Restart the computer in the safe mode.
Safety-Related Issues	Visible signs of smoke or sparks	<ul style="list-style-type: none"> • Do not perform any troubleshooting steps. • Contact Dell immediately.
Intermittent Problems	Monitor malfunctions on & off	<ul style="list-style-type: none"> • Ensure that the video cable connecting the monitor to the computer is connected properly and is secure. • Reset the monitor to Factory Settings. • Perform monitor self-test feature check to determine if the intermittent problem occurs in self-test mode.
Missing Color	Picture missing color	<ul style="list-style-type: none"> • Perform monitor self-test feature check. • Ensure that the video cable connecting the monitor to the computer is connected properly and is secure. • Check for bent or broken pins in the video cable connector.
Wrong Color	Picture color not good	<ul style="list-style-type: none"> • Change the Color Setting Mode in the Color Settings OSD to Graphics or Video depending on the application. • Try different Color Preset Settings in Color Settings OSD. Adjust R/G/B value in Color Settings OSD if the Color Management is turned off. • Change the Input Color Format to PC RGB or YPbPr in the Advance Setting OSD.
Image retention from a static image left on the monitor for a long period of time	Faint shadow from the static image displayed appears on the screen	<ul style="list-style-type: none"> • Use the Power Management feature to turn off the monitor at all times when not in use (for more information, see Power Management Modes). • Alternatively, use a dynamically changing screensaver.

 **NOTE:** When choosing DVI-D / DP mode, the Auto Adjust function is not available.

Product-Specific Problems

Specific Symptoms	What You Experience	Possible Solutions
Screen image is too small	Image is centered on screen, but does not fill entire viewing area	<ul style="list-style-type: none"> • Check the Aspect Ratio setting in the Display OSD. • Reset the monitor to Factory Settings.
Cannot adjust the monitor with the buttons on the front panel	OSD does not appear on the screen	<ul style="list-style-type: none"> • Turn off the monitor, unplug the power cord, plug back, and then turn on the monitor. • Check whether the OSD menu is locked. If yes, press and hold the button beside the Power button for 10 seconds to unlock (for more information, see Lock).
No Input Signal when user controls are pressed	No picture, the LED light is white. When you press "up", "down" or "Menu" key, the message " No input signal" will appear.	<ul style="list-style-type: none"> • Check the signal source. Ensure the computer is not in the power saving mode by moving the mouse or pressing any key on the keyboard. • Check whether the signal cable is plugged in properly. Re-plug the signal cable if necessary. • Reset the computer or video player.
The picture does not fill the entire screen	The picture cannot fill the height or width of the screen	<ul style="list-style-type: none"> • Due to different video formats (aspect ratio) of DVDs, the monitor may display in full screen. • Run the built-in diagnostics.

Dell Soundbar Problems

Common Symptoms	What You Experience	Possible Solutions
No sound for system where the Soundbar draws power from an AC adapter	No power to Soundbar - the power indicator is off	<ul style="list-style-type: none"> • Turn the Power/Volume knob on the Soundbar clockwise to the middle position; check if the power indicator (white LED) on the front of the Soundbar is illuminated. • Confirm that the power cable from the Soundbar is plugged into the adapter.
No Sound	Soundbar has power - power indicator is on	<ul style="list-style-type: none"> • Plug the audio line-in cable into the computer's audio out jack. • Set all volume controls to their maximum and ensure that the mute option is not enabled. • Play some audio content on the computer (example, audio CD, or MP3). • Turn the Power/Volume knob on the Soundbar clockwise to a higher volume setting. • Clean and reseat the audio line-in plug. • Test the Soundbar using another audio source (For example: portable CD player, MP3 player).
Distorted Sound	Computer's sound card is used as the audio source	<ul style="list-style-type: none"> • Clear any obstructions between the Soundbar and the user. • Confirm that the audio line-in plug is completely inserted into the jack of the sound card. • Set all Windows volume controls to their midpoints. • Decrease the volume of the audio application. • Turn the Power/Volume knob on the Soundbar counter-clockwise to a lower volume setting. • Clean and re-seat the audio line-in plug. • Troubleshoot the computer's sound card. • Test the Soundbar using another audio source (For example: portable CD player, MP3 player). • Avoid using an audio cable extension or audio jack converter.

Distorted Sound	Other audio source is used	<ul style="list-style-type: none"> • Clear any obstructions between the Soundbar and the user. • Confirm that the audio line-in plug is completely inserted into the jack of the audio source. • Decrease the volume of the audio source. • Turn the Power/Volume knob on the Soundbar counter-clockwise to a lower volume setting. • Clean and reseat the audio line-in plug.
Unbalanced Sound Output	Sound from only one side of Soundbar	<ul style="list-style-type: none"> • Clear any obstructions between the Soundbar and the user. • Confirm that the audio line-in plug is completely inserted into the jack of the sound card or audio source. • Set all Windows audio balance controls (L-R) to their midpoints. • Clean and reseat the audio line-in plug. • Troubleshoot the computer's sound card. • Test the Soundbar using another audio source (For example: portable CD player, MP3 player).
Low Volume	Volume is too low	<ul style="list-style-type: none"> • Clear any obstructions between the Soundbar and the user. • Turn the Power/Volume knob on the Soundbar clockwise to the maximum volume setting. • Set all Windows volume controls to their maximum. • Increase the volume of the audio application. • Test the Soundbar using another audio source (For example: portable CD player, MP3 player)

Appendix

 **WARNING: Safety Instructions**

 **WARNING: Use of controls, adjustments, or procedures other than those specified in this documentation may result in exposure to shock, electrical hazards, and/or mechanical hazards.**

For information on safety instructions, see the *Product Information Guide*.

FCC Notices (U.S. Only) and Other Regulatory Information

For FCC notices and other regulatory information, see the regulatory compliance website located at www.dell.com/regulatory_compliance.

This device complies with Part 15 of the FCC Rules. Operation is subject to the following two conditions:

- (1) this device may not cause harmful interference
- (2) this device must accept any interference received including interference that may cause undesired operation

Contact Dell

For customers in the United States, call 800-WWW-DELL (800-999-3355).

 **NOTE:** If you do not have an active Internet connection, you can find contact information on your purchase invoice, packing slip, bill, or Dell product catalog.

Dell provides several online and telephone-based support and service options. Availability varies by country and product, and some services may not be available in your area.

To get online monitor support content:

1. Visit www.dell.com/support/monitors

To contact Dell for sales, technical support, or customer service issues:

1. Visit www.dell.com/support.
2. Verify your country or region in the **Choose A Country/Region** drop-down menu at the top left of the page.
3. Click **Contact Us** on the top left side of the page.
4. Select the appropriate service or support link based on your need.
5. Choose the method of contacting Dell that is convenient for you.

Setting Up Your Monitor

Setting the display resolution to 1600 x 900 (for E2015HV) or 1920 x 1080 (for E2215HV/E2715H) (Maximum)

For optimal display performance while using the Microsoft Windows operating systems, set the display resolution to 1600 x 900 (for E2015HV) or 1920 x 1080 (for E2215HV/E2715H) pixels by performing the following steps:

In Windows Vista®, Windows® 7, Windows® 8 or Windows 8.1:

1. For Windows® 8 or Windows 8.1 only, select the Desktop tile to switch to classic desktop.
2. Right-click on the desktop and click Screen Resolution.
3. Click the dropdown list of the screen resolution and select 1600 x 900 (for E2015HV) or 1920 x 1080 (for E2215HV/E2715H).
4. Click OK.

If you do not see 1600 x 900 (for E2015HV) or 1920 x 1080 (for E2215HV/E2715H) as an option, you may need to update your graphics driver. Please choose the scenario below that best describes the computer system you are using, and follow the provided

1: **If you have a Dell desktop or a Dell portable computer with Internet access**

2: **If you have a non Dell desktop, portable computer, or graphics card**

If you have a Dell desktop or a Dell portable computer with Internet access

1. Go to <http://www.dell.com/support>, enter your service tag, and download the latest driver for your graphics
2. After installing the drivers for your graphics adapter, attempt to set the resolution to 1600 x 900 (for E2015HV) or 1920 x 1080 (for E2215HV/E2715H) again.

 **NOTE:** If you are unable to set the resolution to 1600 x 900 (for E2015HV) or 1920 x 1080 (for E2215HV/E2715H), please contact Dell to inquire about a graphics adapter that supports these resolutions.

If you have a non Dell desktop, portable computer, or graphics card

In Windows Vista®, Windows® 7, Windows® 8 or Windows 8.1:

1. For Windows® 8 or Windows 8.1 only, select the Desktop tile to switch to classic desktop.
2. Right-click on the desktop and click Personalization.
3. Click Change Display Settings.
4. Click Advanced Settings.
5. Identify your graphics controller supplier from the description at the top of the window (e.g. NVIDIA, ATI, Intel etc.).
6. Please refer to the graphics card provider website for updated driver (for example, <http://www.ATI.com> OR <http://www.NVIDIA.com>).
7. After installing the drivers for your graphics adapter, attempt to set the resolution to 1600 x 900 (for E2015HV) or 1920 x 1080 (for E2215HV/E2715H) again.



 **NOTE:** If you are unable to set the resolution to 1600 x 900 (for E2015HV) or 1920 x 1080 (for E2215HV/E2715H), please contact the manufacturer of your computer or consider purchasing a graphics adapter that will support the video resolution of 1600 x 900 (for E2015HV) or 1920 x 1080 (for E2215HV/E2715H) .

Procedures for setting up dual monitors in Windows Vista®, Windows® 7 , Windows® 8 or Windows® 8.1

For Windows Vista®

Connect the external monitor(s) to your laptop or desktop using a video cable (VGA, DVI, DP, HDMI etc.) and follow any of the below setup method.

Method 1: Using keyboard shortcut “Win+P”

1. Press the **Windows logo key + P** on your keyboard.  + 
2. While holding down the **Windows logo key**, press **P** to toggle between the display selections.

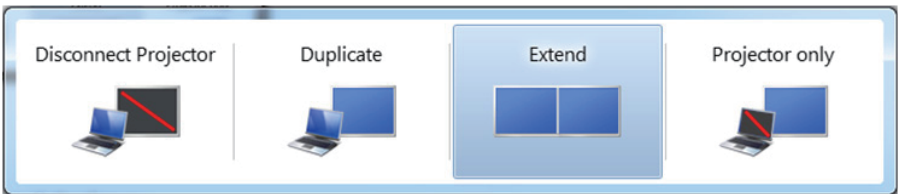

Method 2: Using the “Personalize” menu

1. Right-click on the desktop and click **Personalize**.



2. Click Display Settings.

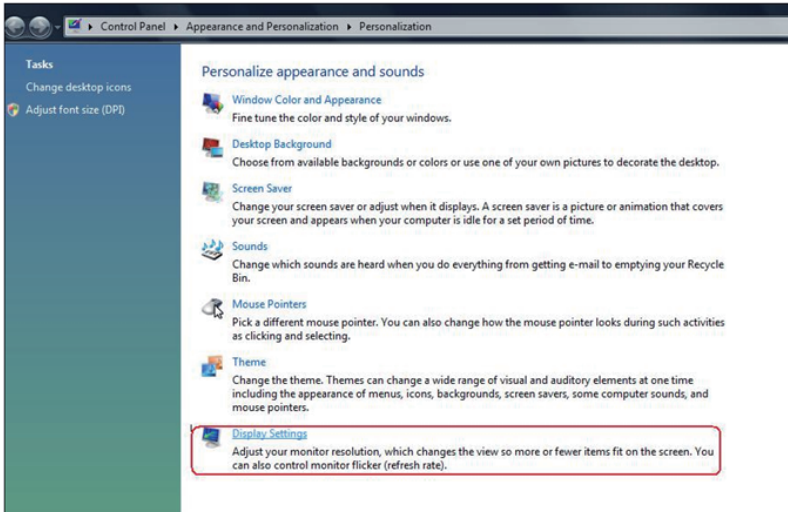

3. Click Identify Monitors.

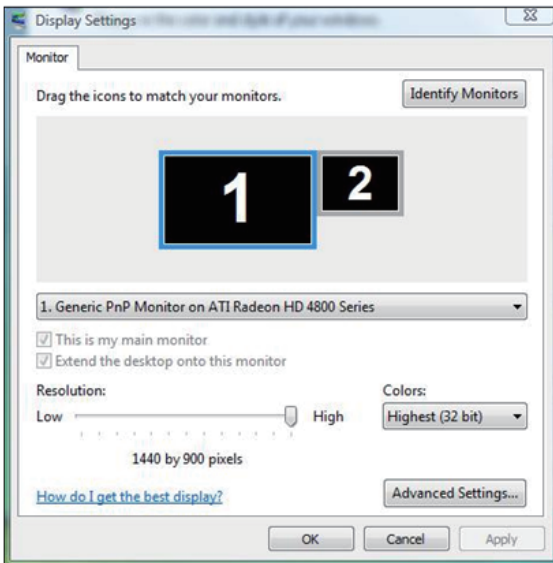

- You may need to restart your system and repeat steps 1 to 3 if the system does not detect the added monitor.



For Windows® 7

Connect the external monitor(s) to your laptop or desktop using a video cable (VGA, DVI, DP, HDMI etc.) and follow any of the below setup method.

Method 1: Using keyboard shortcut “Win+P”

1. Press the **Windows logo key + P** on your keyboard.  + 
2. While holding down the **Windows logo key**, press **P** to toggle between the display selections.



Method 2: Using the “Screen Resolution” menu

1. Right-click on the desktop and click **Screen resolution**.

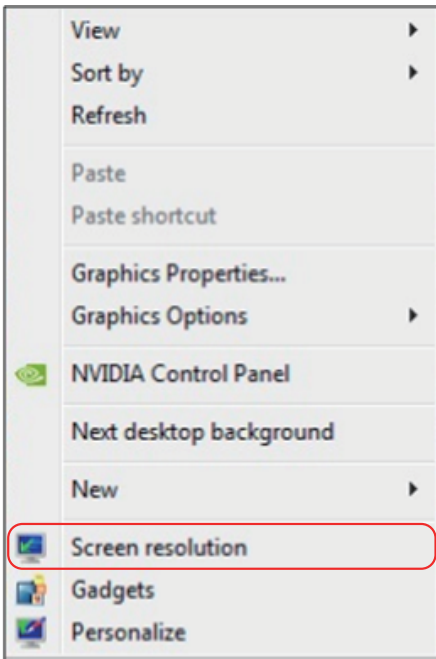

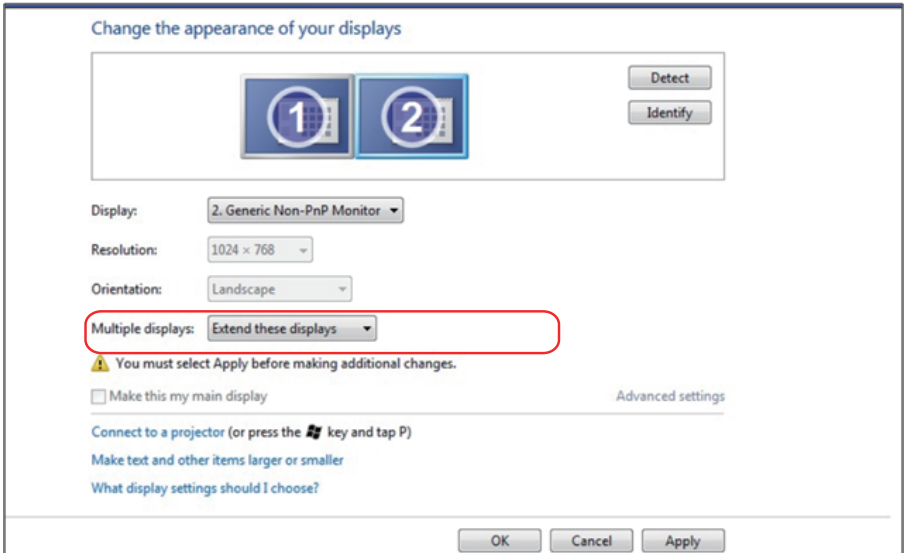

2. Click **Multiple displays** to choose a display selection. If you do not see the additional monitor listed, click **Detect**.
- You may need to restart your system and repeat steps 1 to 3 if the system does not detect the added monitor.



For Windows® 8 or Windows 8.1

Connect the external monitor(s) to your laptop or desktop using a video cable (VGA, DVI, DP, HDMI etc.) and follow any of the below setup method.

Method 1: Using keyboard shortcut “Win+P”

1. Press the **Windows logo key** + **P** on your keyboard.  + 
2. While holding down the **Windows logo key**, press **P** to toggle between the display selections.

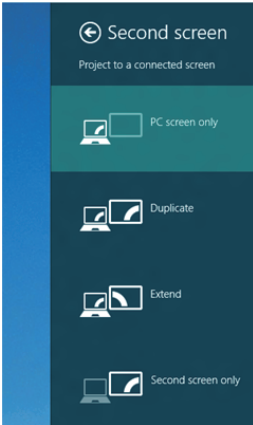

Method 2: Using the “Screen Resolution” menu

1. From the Start screen, select **Desktop** tile to switch to the Classic Windows desktop.



2. Right-click on the desktop and click **Screen resolution**.

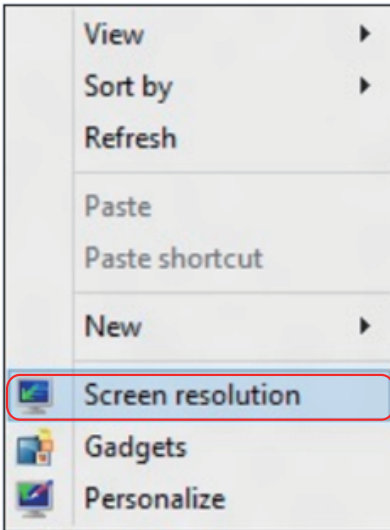

3. Click **Multiple displays** to choose a display selection. If you do not see the additional monitor listed, click Detect.

- You may need to restart your system and repeat steps 1 to 3 if the system does not detect the added monitor.

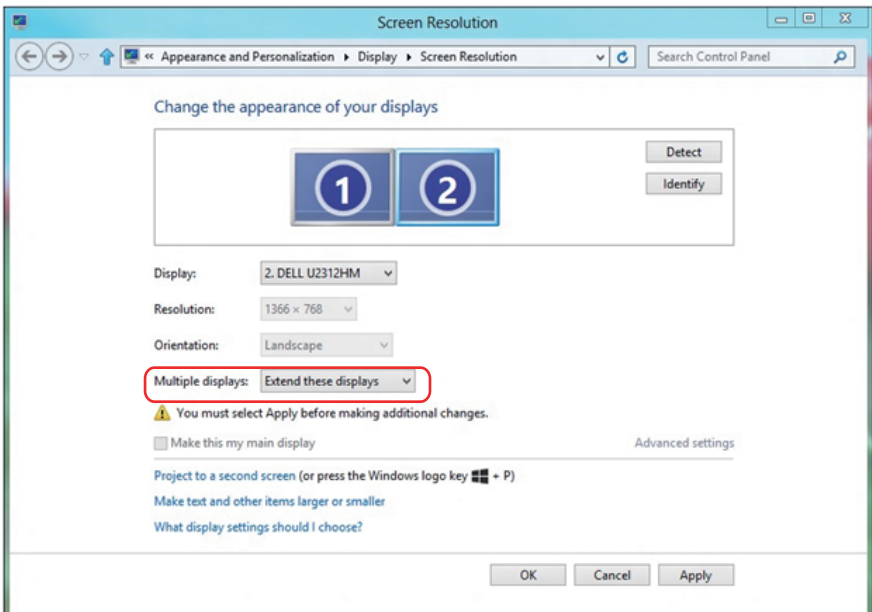

Setting Display Styles For Multiple Monitor

After the external monitor(s) have been set up, users can select the desired display style from **Multiple displays** menu: Duplicate, Extend, Show Desktop On.

- **Duplicate these displays:** Duplicate the same screen on two monitors with the same resolution, chosen based on the monitor with a lower resolution.

For Windows Vista®

[DUPLICATE NOT AVAILABLE]

For Windows® 7

Change the appearance of your displays

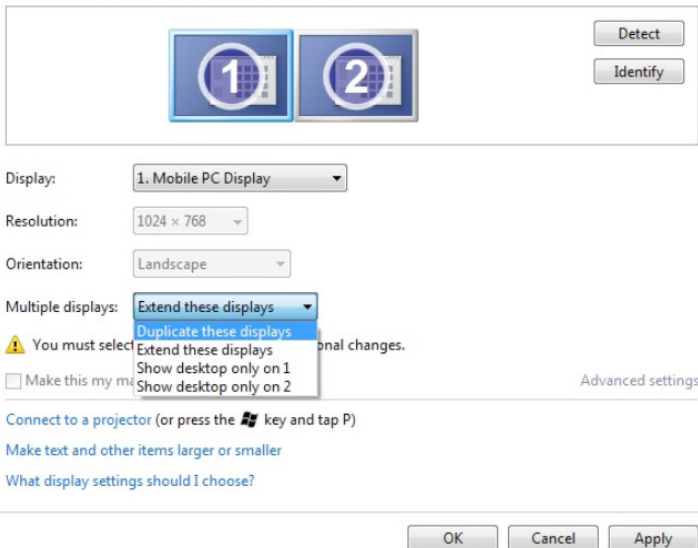

The screenshot shows the Windows 7 Display Settings window. At the top, there are two monitor icons labeled '1' and '2'. To the right are 'Detect' and 'Identify' buttons. Below the icons, the 'Display' dropdown is set to '1. Mobile PC Display', 'Resolution' is '1024 x 768', and 'Orientation' is 'Landscape'. The 'Multiple displays' dropdown is open, showing options: 'Extend these displays' (selected), 'Duplicate these displays', 'Show desktop only on 1', and 'Show desktop only on 2'. A warning icon and text state: 'You must select a display style when you make additional changes.' There is also a checkbox for 'Make this my main display' and a link for 'Advanced settings'. At the bottom, there are 'OK', 'Cancel', and 'Apply' buttons.

For Windows® 8 or Windows 8.1

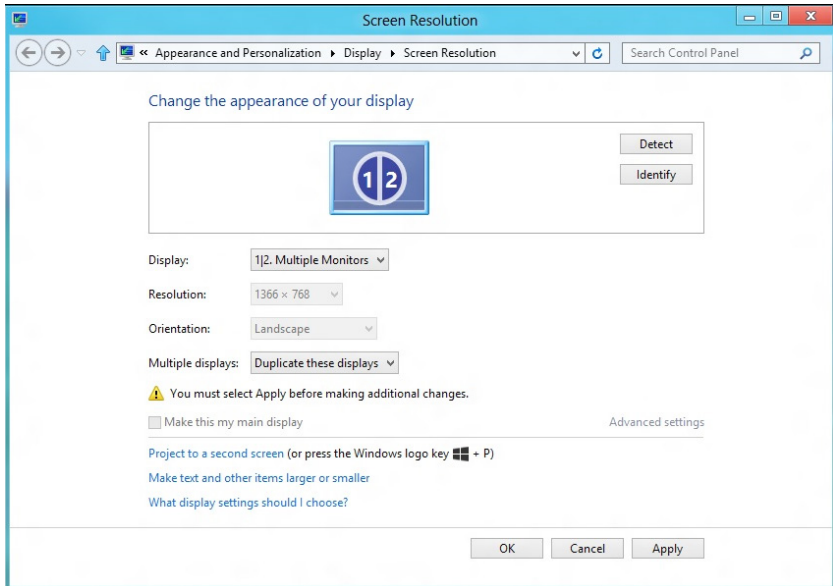

- **Extend these displays:** This option is recommended when an external monitor is connected to a laptop, and each monitor can display different screen independently to improve user convenience. The relative position of the screens can be set up here, for example monitor 1 may be set up to be to the left of monitor 2 or vice versa. This depends on the physical position of the LCD monitor in relation to the laptop. The horizontal line displayed on both monitors can be based on the laptop or external monitor. These are all adjustable options, and all a user need do is drag the monitor of the main screen to the extended monitor.

For Windows Vista®

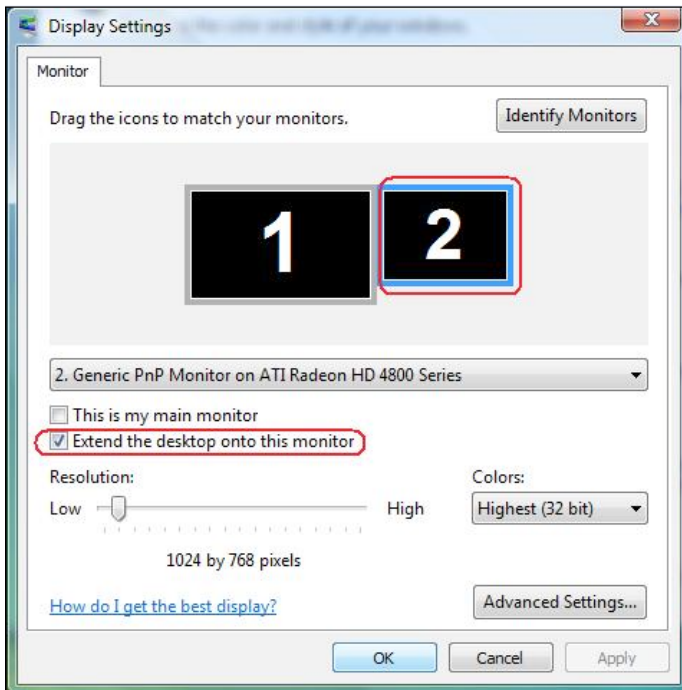

For Windows® 7

Change the appearance of your displays

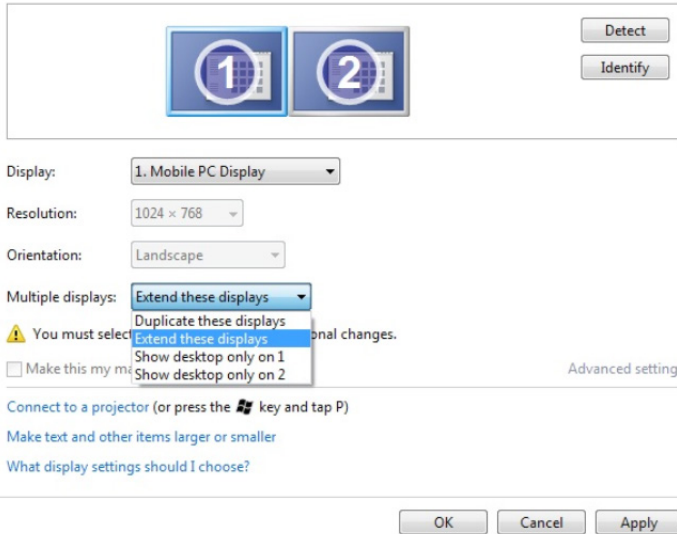

The screenshot shows the Windows 7 Display Settings dialog box. At the top, there are two monitor icons labeled '1' and '2'. To the right are 'Detect' and 'Identify' buttons. Below the icons, the 'Display:' dropdown is set to '1. Mobile PC Display'. The 'Resolution:' dropdown is set to '1024 x 768'. The 'Orientation:' dropdown is set to 'Landscape'. The 'Multiple displays:' dropdown is open, showing options: 'Extend these displays' (selected), 'Duplicate these displays', 'Show desktop only on 1', and 'Show desktop only on 2'. A yellow warning icon is present with the text 'You must select a display mode before making additional changes.' Below this is a checkbox for 'Make this my main display' which is unchecked. To the right of the checkbox is a link for 'Advanced settings'. At the bottom of the dialog are 'OK', 'Cancel', and 'Apply' buttons.

For Windows® 8 or Windows 8.1

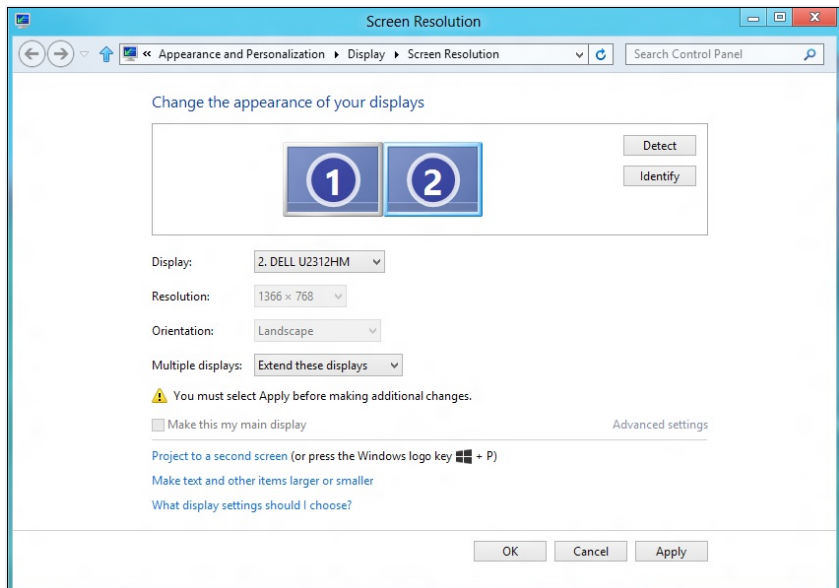

The screenshot shows the Windows 8/8.1 Screen Resolution dialog box. The title bar reads 'Screen Resolution'. The breadcrumb path is 'Appearance and Personalization > Display > Screen Resolution'. Below the breadcrumb is a search bar for the Control Panel. The main heading is 'Change the appearance of your displays'. There are two monitor icons labeled '1' and '2'. To the right are 'Detect' and 'Identify' buttons. Below the icons, the 'Display:' dropdown is set to '2. DELL U2312HM'. The 'Resolution:' dropdown is set to '1366 x 768'. The 'Orientation:' dropdown is set to 'Landscape'. The 'Multiple displays:' dropdown is set to 'Extend these displays'. A yellow warning icon is present with the text 'You must select Apply before making additional changes.' Below this is a checkbox for 'Make this my main display' which is unchecked. To the right of the checkbox is a link for 'Advanced settings'. Below the checkbox is a link for 'Project to a second screen (or press the Windows logo key + P)'. Below that are links for 'Make text and other items larger or smaller' and 'What display settings should I choose?'. At the bottom of the dialog are 'OK', 'Cancel', and 'Apply' buttons.

- **Show desktop only on...:** Display the status of a particular monitor. This option is typically chosen when the laptop is used as a PC so the user can enjoy a large external monitor. Most current laptops support mainstream resolutions. As shown in the figure above, the resolution of the laptop monitor is only 1280 x 800, but after connecting a 27" external LCD monitor, users can immediately improve their visual enjoyment to 1920 x 1080 Full HD quality.

For Windows Vista®

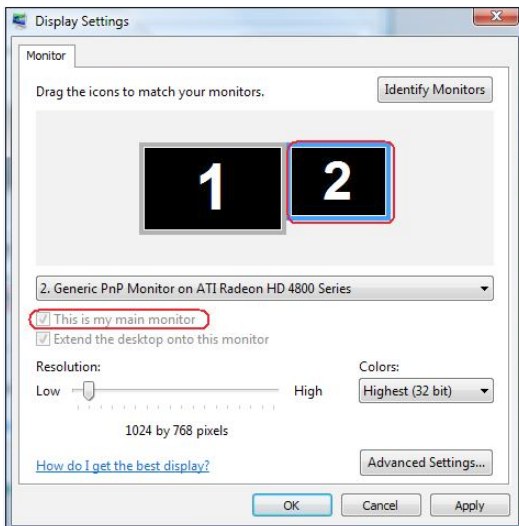
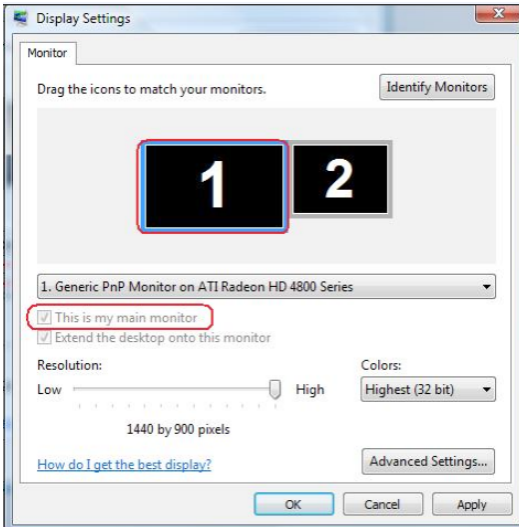

For Windows® 7

Change the appearance of your displays

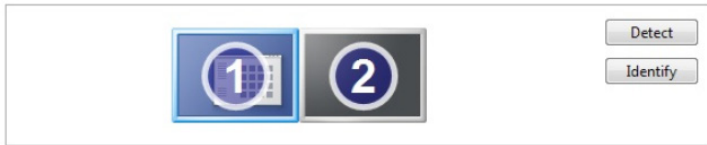

Display: 1. Mobile PC Display

Resolution: 1024 × 768

Orientation: Landscape

Multiple displays: Show desktop only on 1

 You must select a display mode for each monitor. [Advanced settings](#)

Make this my main display

[Connect to a projector](#) (or press the  key and tap P)

[Make text and other items larger or smaller](#)

[What display settings should I choose?](#)

OK

Cancel

Apply

Change the appearance of your displays



Display: 1. Mobile PC Display

Resolution: 1024 × 768

Orientation: Landscape

Multiple displays: Show desktop only on 2

 You must select a display mode for each monitor. [Advanced settings](#)

Make this my main display

[Connect to a projector](#) (or press the  key and tap P)

[Make text and other items larger or smaller](#)

[What display settings should I choose?](#)

OK

Cancel

Apply

For Windows® 8 or Windows 8.1

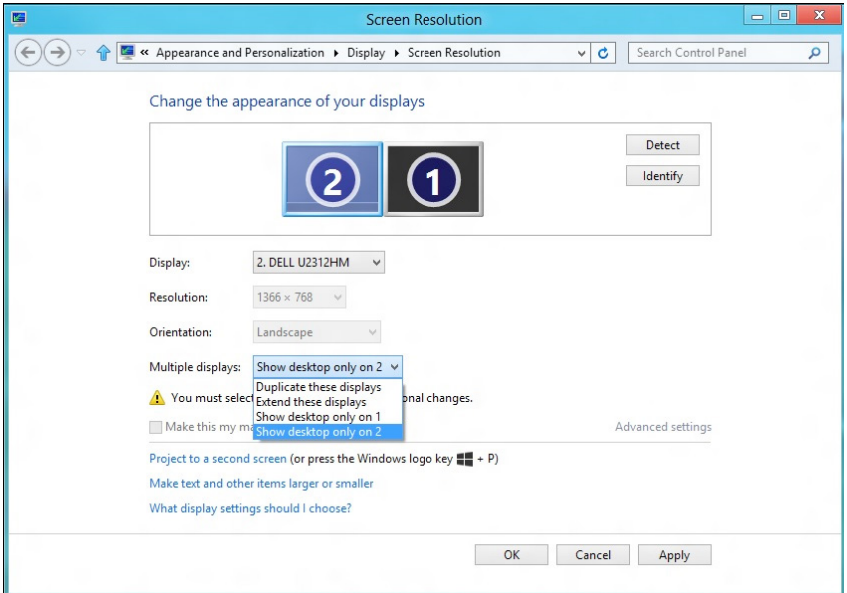
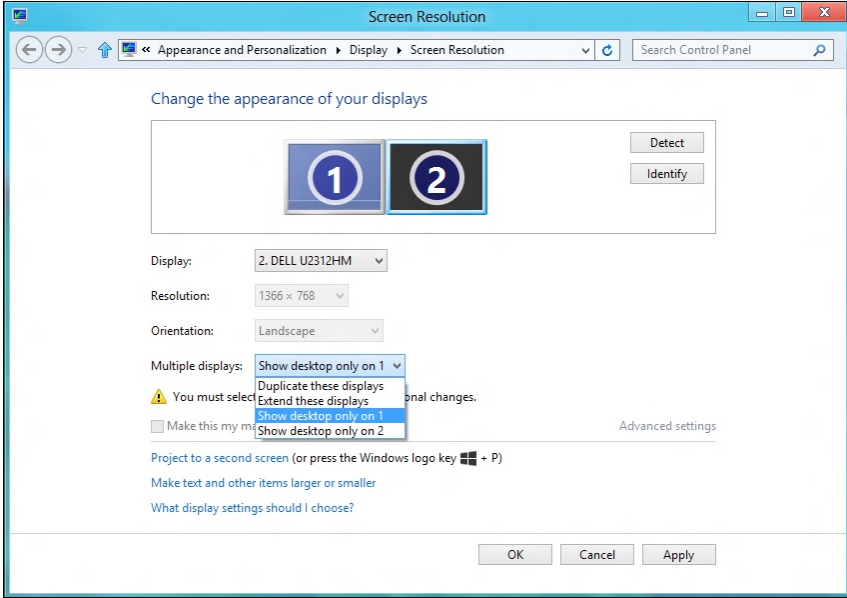

Free Manuals Download Website

<http://myh66.com>

<http://usermanuals.us>

<http://www.somanuals.com>

<http://www.4manuals.cc>

<http://www.manual-lib.com>

<http://www.404manual.com>

<http://www.luxmanual.com>

<http://aubethermostatmanual.com>

Golf course search by state

<http://golfingnear.com>

Email search by domain

<http://emailbydomain.com>

Auto manuals search

<http://auto.somanuals.com>

TV manuals search

<http://tv.somanuals.com>