

SUB

612

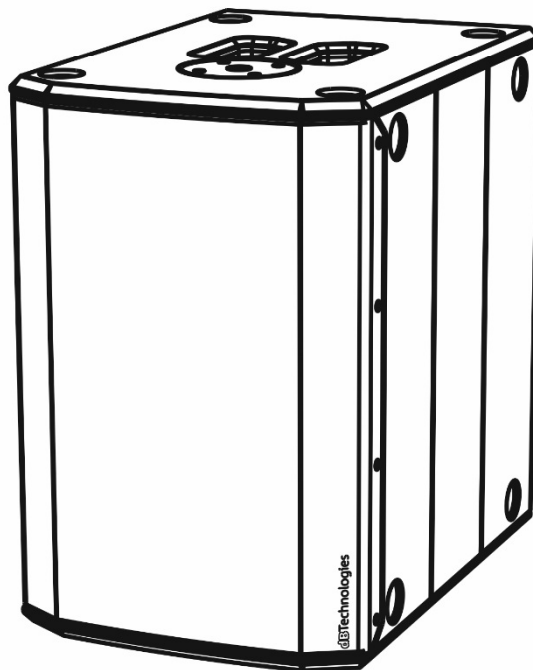

Quick start user manual *Section 1*

The warnings in this manual must be observed together with the "USER MANUAL - Section 2".

Le avvertenze nel presente manuale devono essere osservate congiuntamente al "MANUALE D'USO - Sezione 2".

Die Warnungen in diesem Handbuch müssen in Verbindung mit der "BEDIENUNGSANLEITUNG - Abschnitt 2" beobachtet werden".

Les avertissements spécifiés dans ce manuel doivent être respectés ainsi que les "CARACTERISTIQUES TECHNIQUES - Section 2".

Las advertencias del presente manual se deben tener en cuenta conjuntamente con las del "MANUAL DEL USUARIO" - Sección 2".

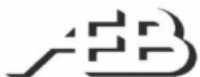

A.E.B. Industriale Srl Via Brodolini, 8 Località Crespellano 40053 VALSAMOGGIA BOLOGNA (ITALIA)
Tel +39 051 969870 Fax +39 051 969725 www.dbtechnologies.com info@dbtechnologies-aeb.com



Thank you for choosing a dBTechnologies Product!

The new SUB 612 is an active subwoofer. It is equipped with one 12" transducer (2.5" voice coil). It is portable, thanks to the compact size, low weight and the convenient handle.

It allows a mono or stereo input and output connections, and a complete configuration with different parameters controls. Thanks to the settings of polarity, low-frequencies enhancement, and of possible crossover filtering in output, it is possible to use it in different scenarios. A typical configuration is the matching with B-Hype and Opera series speakers, thanks to the M20 pole mount on the top. The subwoofer is also stackable.

Check the site www.dbtechnologies.com for the complete user manual!

1) Unpacking

The box contains:

N°1 SUB 612

N°1 Mains cable (VDE)

This quick start and warranty documentation

2) Easy installation

SUB 612 is equipped with:

A – Houses for stack mounting

B – Handle (1 on the top)

C – M20 pole mount

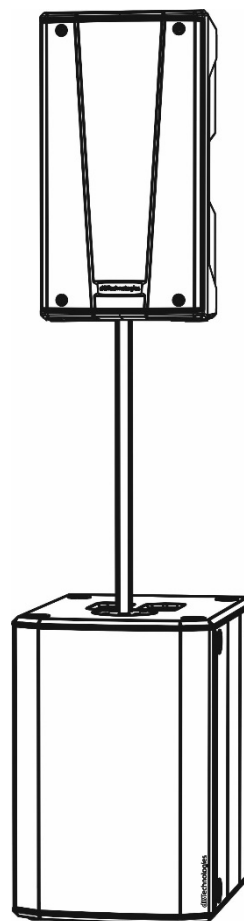
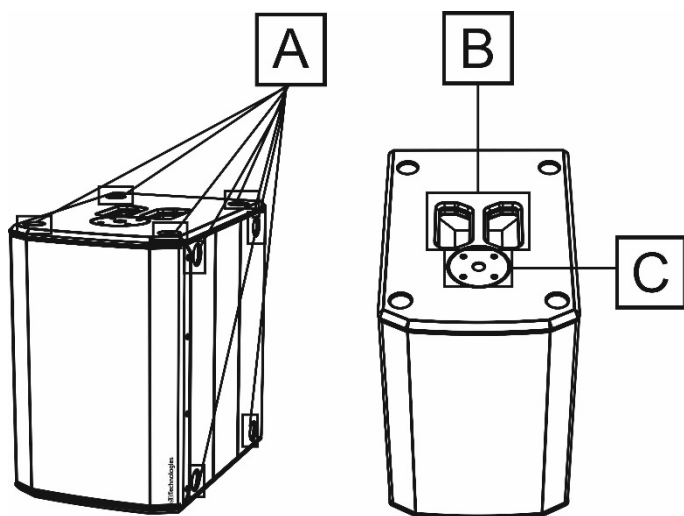

In the pictures above is shown an example of configuration for the use of SUB 612.

The matching with a speaker (like one of the OPERA or B-HYPE series) allows a perfect performance in an extended frequency range. SUB 612 is perfect for gigging bands, like for small-medium venue installations. The design allows the user also to install the subwoofer stacked (max 2 elements) in vertical or in horizontal position. For further information check the complete user manual.



NEVER USE THE HANDLES TO SUSPEND THE SPEAKER!

Those mechanical particulars were thought for an easy use and for different configuration needs.



IT IS MANDATORY TO READ AND FULLY UNDERSTAND THE COMPLETE USER MANUAL FOR THE ADMITTED CONFIGURATIONS OF THE PRODUCT, SAFETY INFORMATION, AND THE PROPER USE OF ACCESSORIES (IF ANY).

3) Connections and controls

All the connections and controls are in the amplifier panel side:

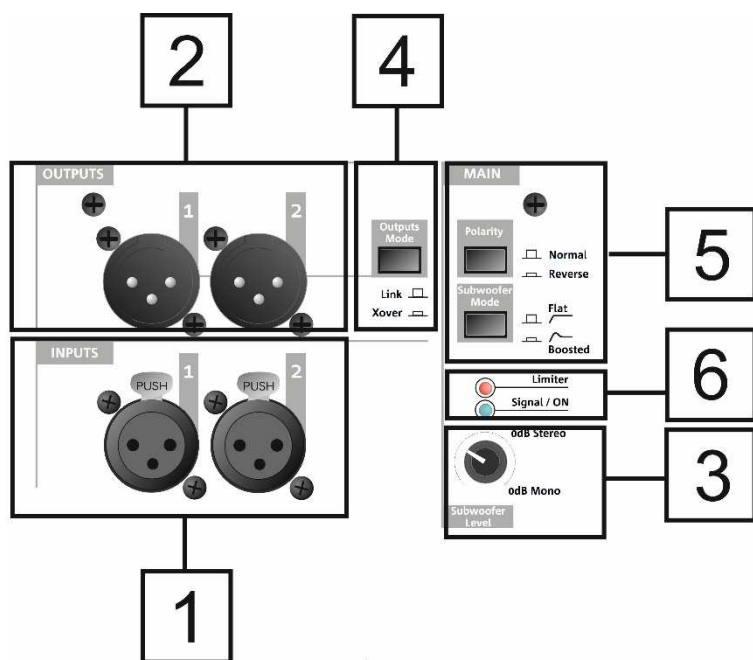

- 1 – Balanced XLR inputs
- 2 – Balanced XLR outputs
- 3 – Subwoofer level rotary
- 4 – Outputs Mode (Link or Xover mode)
- 5 – Subwoofer Setup (Polarity switch) and Subwoofer Mode button (Flat/Boosted)
- 6 – LEDs (Limiter, Signal / ON)
- 7 – Mains input connector
- 8 – Power switch (ON, OFF)

a) Once you have properly set up the desired configuration (see also the complete user manual and accessories instructions for further information), connect the audio input (mono) or inputs (stereo) (1). Connect the output (mono) or outputs (stereo) (2) and consequently set the Subwoofer level to 0 dB in the right position (3).

b) Set properly the Outputs Mode (4): “Link” in case of direct link connection, “Xover” for example in case of use with a OPERA or B-HYPE series model.

c) Choose the Subwoofer Polarity (Normal or Reverse) (5) to obtain the proper behavior. It is possible to add a low-frequencies boost (5) with the related Subwoofer Mode switch.

d) Connect the VDE cable to the related connector (7). Then turn ON the power switch (8). The, the “Signal/ON” LED (6) turns on, signaling the proper power connection, and starts blinking at the presence of audio signal (greater than -20 dBu).

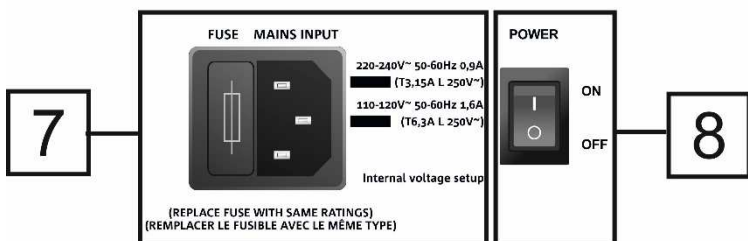
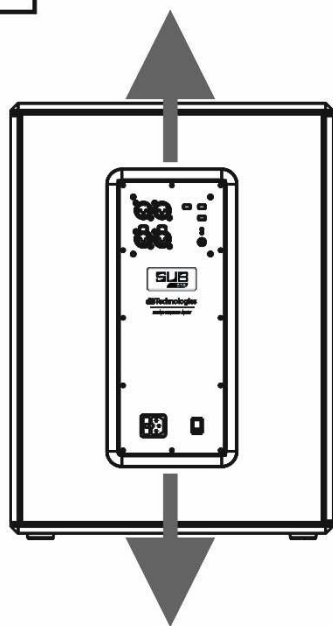

Check the complete user manual on www.dbtechnologies.com for further information about the system and available accessories.

Scarica il manuale completo da www.dbtechnologies.com per ogni ulteriore informazione sul sistema e sugli accessori disponibili.

Für weitere Informationen und verfügbares Zubehör lesen sie bitte die vollständige Bedienungsanleitung unter www.dbtechnologies.com.

Vérifiez le manuel de l'utilisateur complet sur www.dbtechnologies.com pour des informations complémentaires du système et des accessoires disponibles.

Compruebe el manual de usuario completo sobre www.dbtechnologies.com para la información adicional sobre el sistema y accesorios disponibles.

Technical Data

Speaker Type: Active subwoofer
Usable Bandwidth [-10 dB]: 46 - 123 Hz
Max SPL (1 m): 129 dB
LF: 12"
LF Voice Coil: 2.5"

Amplifier

Amp Technology: SMPS digital amplifier
Amp Class: Class-D – Passive cooling (convection)
RMS Power: 600 W
Peak Power: 1200 W

Operating voltage (factory set):

220-240V~ (50-60Hz) or
110-120V~ (50-60 Hz)

Processor and user interface

Controller: 28/56 bit DSP
Limiter: Peak, Thermal, RMS
Controls: Subwoofer level, Outputs mode, Polarity, Subwoofer mode

Inputs / Outputs

Signal Input: 2 x XLR (balanced)
Signal Out: 2 x XLR (balanced)
Mains connections: VDE

Mechanics

Housing: Plywood
Grille: Full metal grille
Pole Mount: Yes, M20
Width: 360 mm (14.72 in)
Height: 550 mm (21.65 in)
Depth: 525 mm (20.67 in)
Weight: 19.8 kg (43.65 lbs.)



Scan with your QR Reader
App to download the
complete User Manual

POWER SUPPLY SPECIFICATIONS (POWER ABSORPTION)

Draw at 1/8 of full power in average use conditions (*): 0.9 A (220-240V~) - 1.6 A (110-120V~)
Draw at 1/3 of full power in maximum use conditions (**): 1.7 A (220-240V~) - 2.8 A (110-120V~)
Power absorption with speaker turned on without signal (idle): 16 W

** INSTALLER NOTES: The values refer to 1/8 of full power, in average operating conditions (music program with infrequent or no clipping). It is recommended to consider them the minimum sizing values for any type of configuration.*
*** INSTALLER NOTES: The values refer to 1/3 of full power, in heavy operating conditions (music program with frequent clipping or activation of the limiter). We recommend sizing according to these values in case of professional installations and tours.*

Download the complete user manual on: www.dbtechnologies.com/EN/Downloads.aspx

EMI CLASSIFICATION

According to the standards EN 55103 this equipment is designed and suitable to operate in E3 (or lower E2, E1) Electromagnetic environments.
FCC CLASS B STATEMENT ACCORDING TO TITLE 47, PART 15, SUBPART B, §15.105

This equipment has been tested and found to comply with the limits for a Class B digital device, pursuant to part 15 of the FCC Rules. These limits are designed to provide reasonable protection against harmful interference in a residential installation.

This equipment generates, uses and can radiate radio frequency energy and, if not installed and used in accordance with the instructions, may cause harmful interference to radio communications.

However, there is no guarantee that interference will not occur in a particular installation. If this equipment does cause harmful interference to radio or television reception, which can be determined by turning the equipment off and on, the user is encouraged to try to correct the interference by one or more of the following measures:

1. Reorient or relocate the receiving antenna.
2. Increase the separation between the equipment and receiver.
3. Connect the equipment into an outlet on a circuit different from that to which the receiver is connected.
4. Consult the dealer or an experienced radio/TV technician for help.

Changes or modifications not expressly approved by the party responsible for compliance could void the user's authority to operate the equipment.

WARNING: Make sure that the loudspeaker is securely installed in a stable position to avoid any injuries or damages to persons or properties. For safety reasons do not place one loudspeaker on top of another without proper fastening systems. Before hanging the loudspeaker check all the components for damages, deformations, missing or damaged parts that may compromise safety during installation. If you use the loudspeakers outdoor avoid spots exposed to bad weather conditions.

Contact dB Technologies for accessories to be used with speakers. dBTechnologies will not accept any responsibility for damages caused by inappropriate accessories or additional devices.

Features, specification and appearance of products are subject to change without notice.

dBTechnologies reserves the right to make changes or improvements in design or manufacturing without assuming any obligation to change or improve products previously manufactured.

Free Manuals Download Website

<http://myh66.com>

<http://usermanuals.us>

<http://www.somanuals.com>

<http://www.4manuals.cc>

<http://www.manual-lib.com>

<http://www.404manual.com>

<http://www.luxmanual.com>

<http://aubethermostatmanual.com>

Golf course search by state

<http://golfingnear.com>

Email search by domain

<http://emailbydomain.com>

Auto manuals search

<http://auto.somanuals.com>

TV manuals search

<http://tv.somanuals.com>