

CT-S300 Casiotone

Quick Start Guide

After reading this document, keep it in a safe place along with the warranty certificate. Be sure to read the "Safety Precautions" in the separate "READ THIS!" sheet, and use the product correctly.

For more detailed information about the product and its operation, visit the CASIO website by accessing the nearby QR code or the URL below.
 Available Information: User's Guide, Music Scores, etc.
<https://support.casio.com/global/en/emi/manual/CT-S300/>



Included Accessories

- Music Stand
 - Leaflets
 - READ THIS! Sheet
 - Other (Warranty, etc.)
- Items included as accessories are subject to change without notice.

Preparation

Preparing a Power Supply

Using the AC Adaptor

- 1 Connect the AC adaptor as shown in the nearby illustration.

Using Batteries

- 1 Open
- 2 Load six AA-size batteries.
- 3 Close
- 4 Specify the battery type.
 - See "Configuring Function Settings" on the reverse side of this sheet.

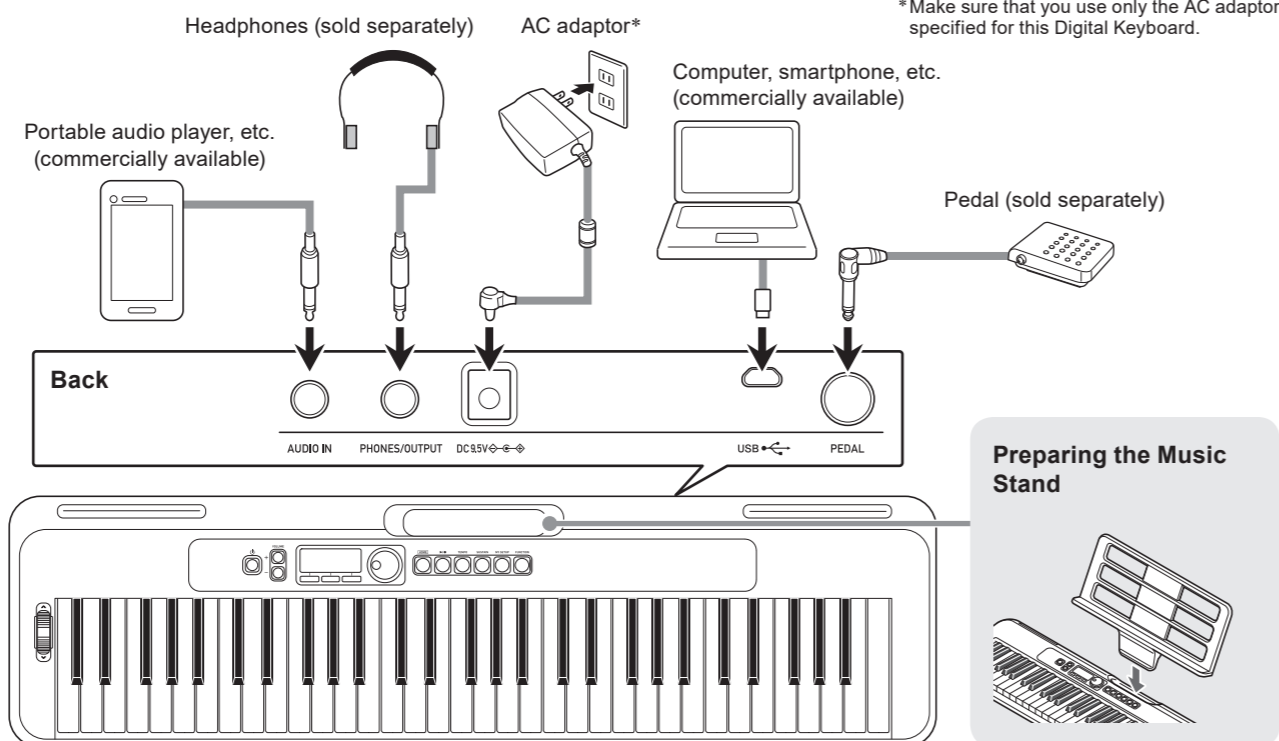

Preparing the Music Stand

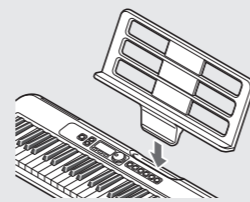

Selecting a Tone

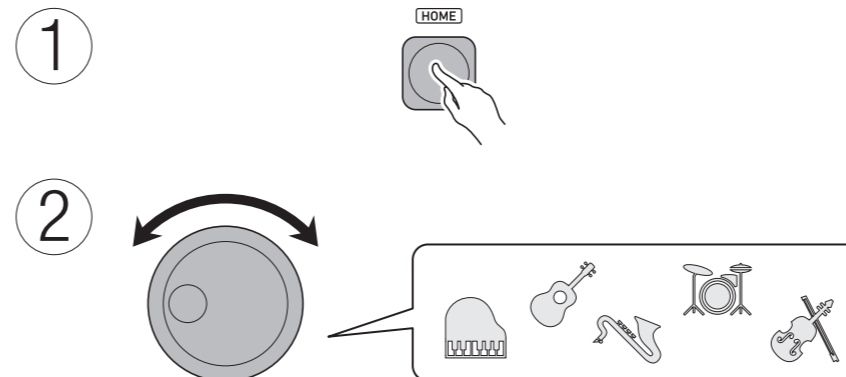

Category	No.	Category	No.
PIANO	001 - 014	BRASS	121 - 140
ELECTRIC PIANO	015 - 028	REED/PIPE	141 - 165
CHROMATIC PERC.	029 - 042	SYNTH-LEAD	166 - 202
ORGAN	043 - 064	SYNTH-PAD	203 - 242
GUITAR	065 - 078	INDIAN	243 - 253
BASS	079 - 088	ETHNIC	254 - 266
STR/ORCHESTRA	089 - 100	GM TONES	267 - 394
ENSEMBLE	101 - 120	DRUM SET	395 - 400

Saving and Loading Instrument Settings

To save to My Setups

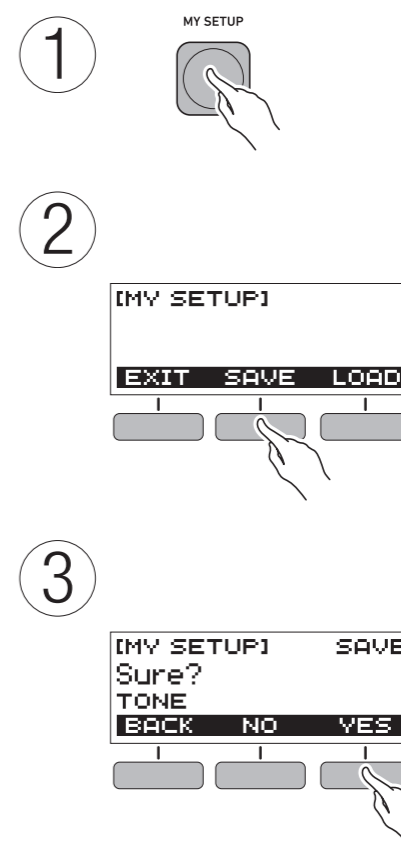

To load from My Setups

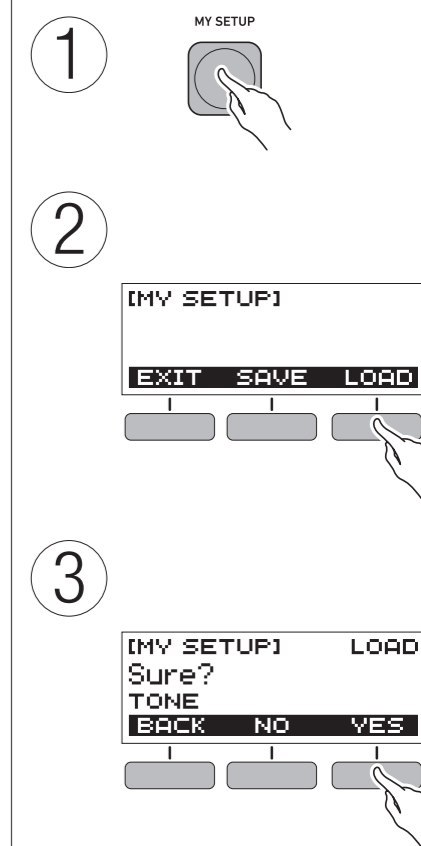

Basic Operation

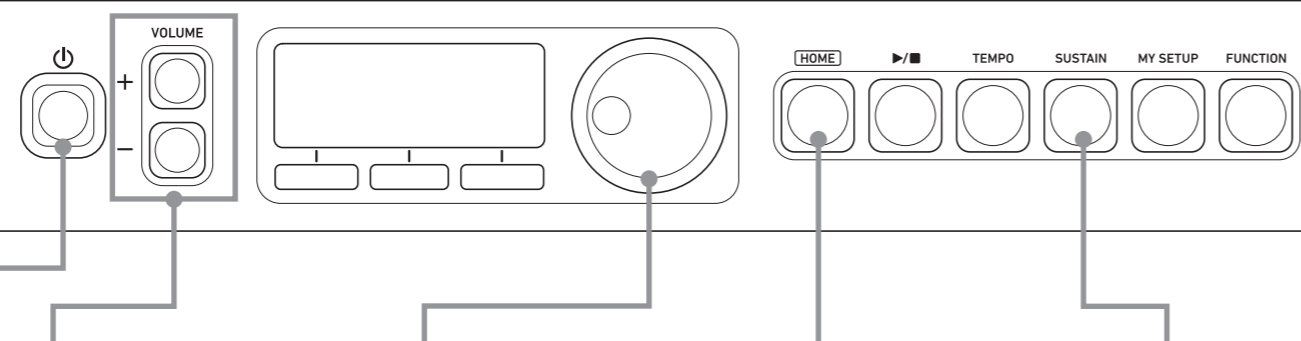

- Power button**
Press to turn on power. To turn off power, hold down this button until the display goes blank.
- Volume buttons**
Use to adjust the overall volume level range.
- Dial**
Rotate to change a displayed number or value.
- HOME button**
Press to return to the Home (tone selection) screen.
- SUSTAIN button**
Pressing causes notes to be sustained longer when keyboard keys are released. Pressing again returns to unsustained notes.

- Pitch Bend Wheel**
Rotate for a smooth change in the pitch of a note that is sounding.
- Auto Power Off**
Automatically turns off power after 30 minutes of non-use. (On, Off switchable)
- Pedal**
Sustains notes played while the pedal is depressed. Even if the keys played are released, notes are sustained as if the keys remain pressed, until the pedal is released.
- Touch Response**
Pressing a key harder produces louder sound, while a softer key press produces softer sound.

Sounding the Metronome

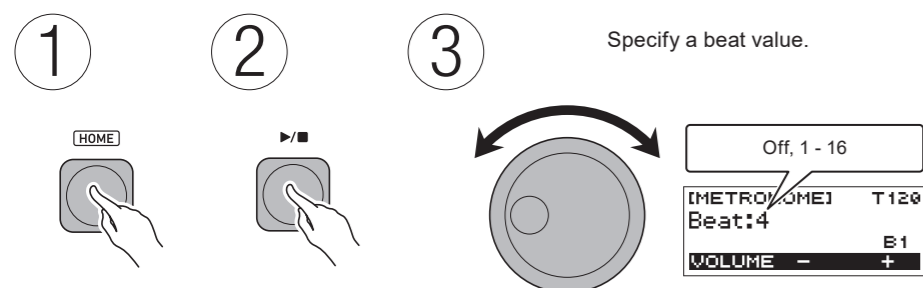

Changing the Tempo

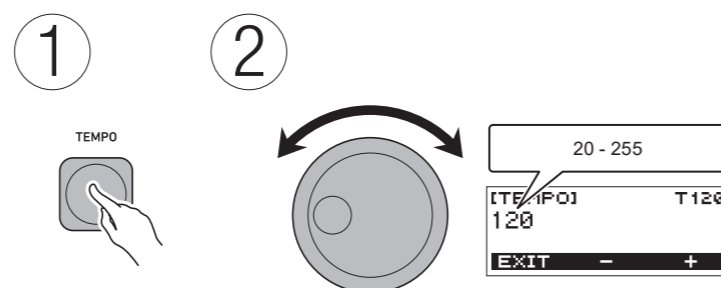

Playing a Built-in Song

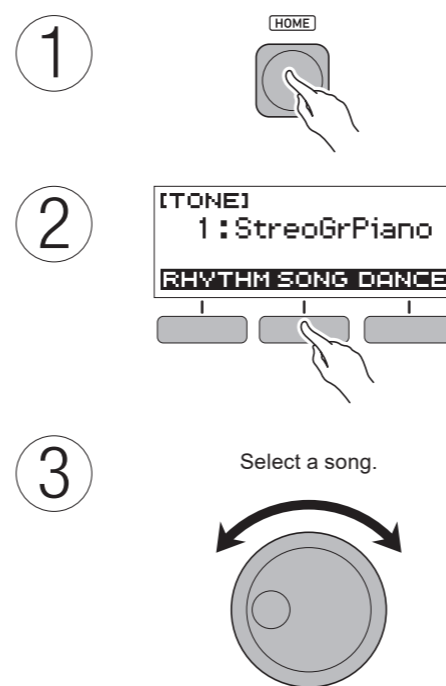

Category	No.
PIANO/CLASSICS	01 - 30
EVENT	31 - 35
WORLD	36 - 60

To play the song

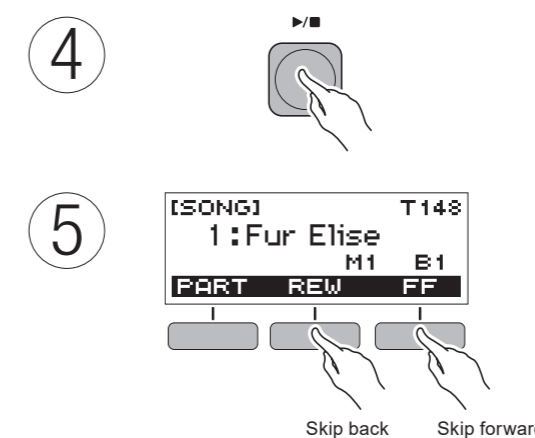

To practice a particular part

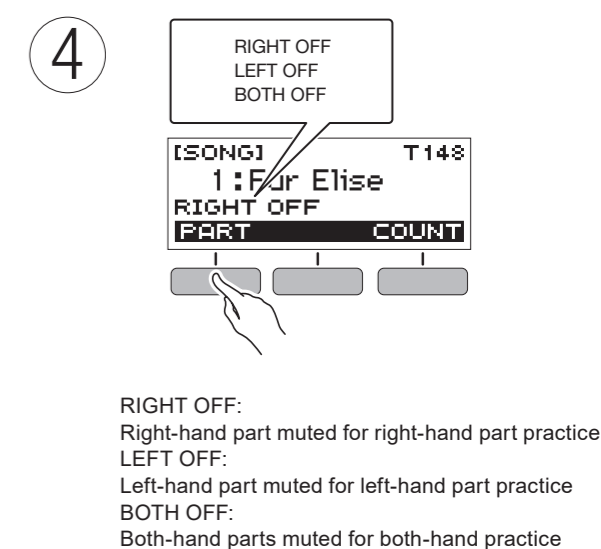

To sound a count

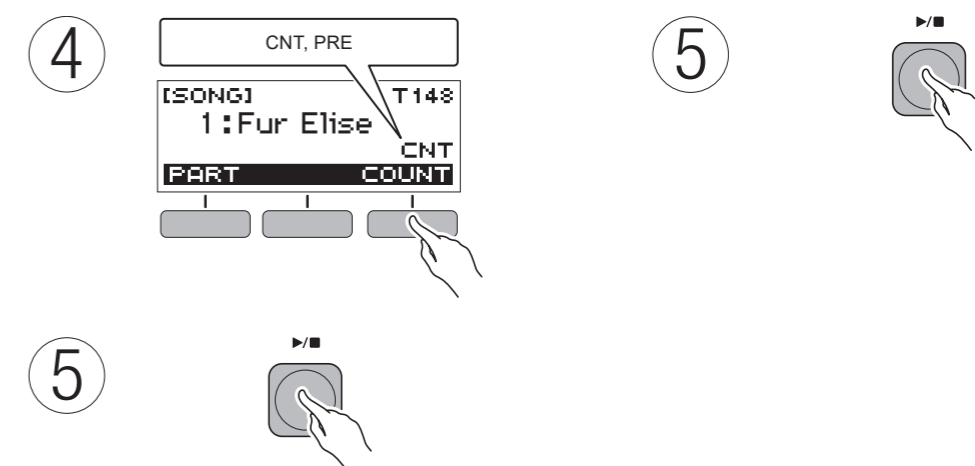

Enjoying DJ Play in the Dance Music Mode

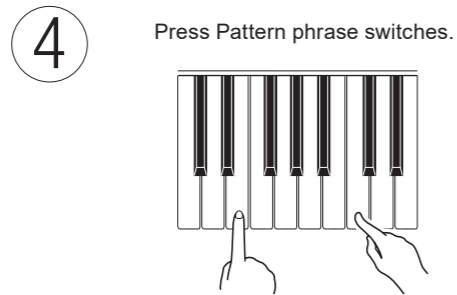
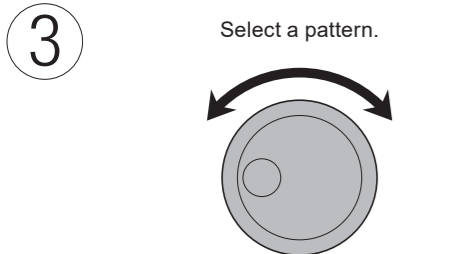
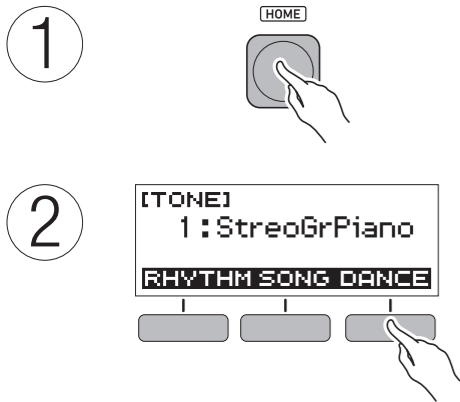

- Pressing the phrase switch of a phrase that is sounding stops the phrase.
- By selecting phrases for each part, you can perform dance music incorporating various combinations.
- You can also start or stop phrase play by pressing the ►/■ button.

Category	No.
EDM	01 - 35
HOUSE	36 - 45
HIP-HOP	46 - 50

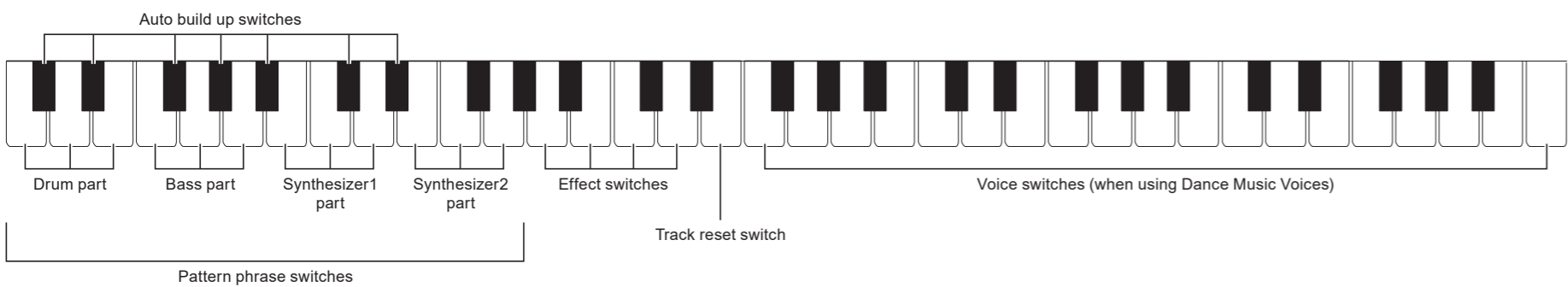

To use a Dance Music voice

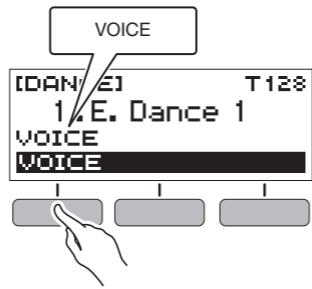

Press a Voice Switch.

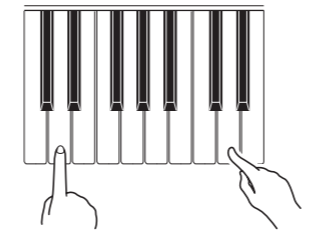

Configuring Function Settings

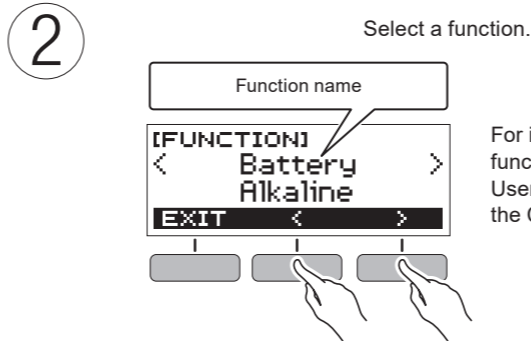

For information about functions, refer to the User's Guide available on the CASIO Website.

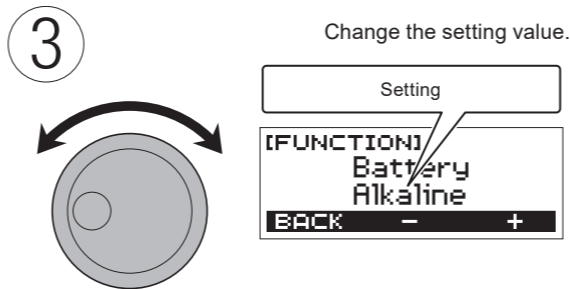

Example: To specify the battery type
Alkaline: Alkaline batteries
Ni-MH: Rechargeable nickel metal hydride batteries

To initialize a setting

Select "Initialize".

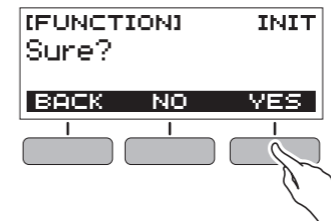
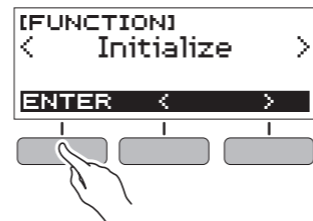

Playing a Rhythm

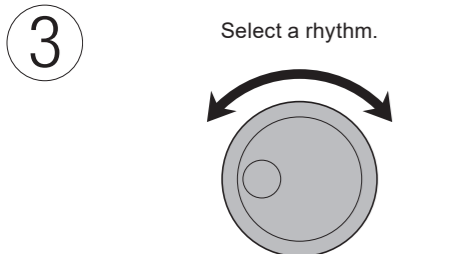
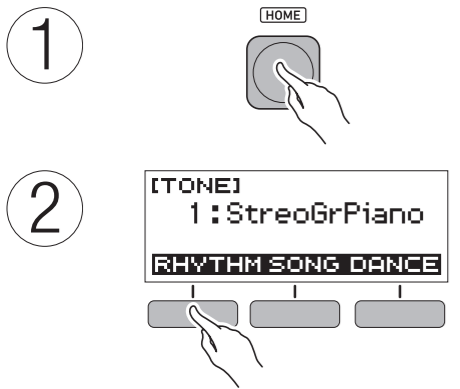

To change the pattern

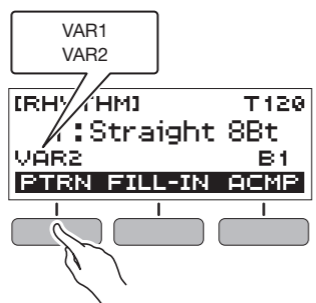

To sound the accompaniment pattern with chords

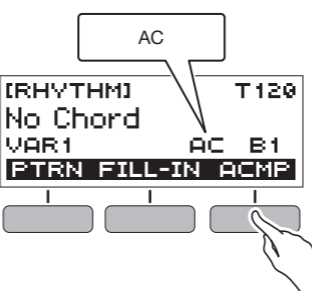

To insert a fill-in

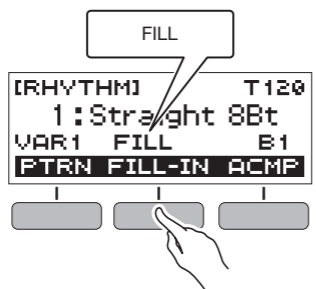

Use the chord input keyboard to play chords.



Chord Progression Example

Input the following chords for the progression:
C → F → C → G.
Inputting a chord when there is a change from one measure to the next is recommended.

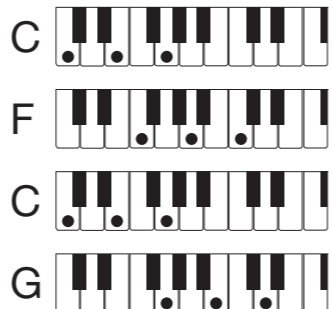

Category	No.	Category	No.	Category	No.
8 BEAT	001 - 002	ROCK	017 - 020	WORLD	059 - 073
16 BEAT	003 - 005	JAZZ	021 - 024	VARIOUS	074 - 075
BALLAD	006 - 009	EUROPEAN	025 - 032	PIANO RHYTHMS	076 - 077
DANCE	010 - 013	LATIN	033 - 044		
POPS	014 - 016	INDIAN	045 - 058		

Product Specifications

- Model:** CT-S300
- Keyboard:** 61 keys
- Touch Response:** 2 levels, Off
- Maximum polyphony:** 48 tones
- Sound Source:** 400 preset tones (1 stereo piano tone)
- Effects:** Reverb (10 types, Off)
- Metronome:** Bell sound off, 1 to 16 beats; Tempo Range: 20 to 255
- Song Bank:** 60 preset songs; Part Off Function: Left-hand, right-hand, both-hand
- Auto Accompaniment:** 77 preset rhythms, 77 one-touch presets, INTRO, ENDING; chord input mode switching
- Dance Music Mode:** 50 preset patterns; Dance Music effects
- Demo Function:** Looped play of all built-in Song Bank songs (60 songs)
- Function Volume Adjustment:** Metronome, Rhythm, Song, Dance Music
- Other Functions:** Transpose (±1 octave; -12 to 0 to +12 semitones), Tuning (A4 = 415.5 to 465.9 Hz; Default = 440.0 Hz)
- APP Function:** iOS, Android (Connects via USB port)
- Pitch Bend Wheel:** 0 to 12 semitones
- Input/Output Terminals:** PHONES/OUTPUT jack: Stereo mini jack (3.5mm); AUDIO IN jack: Stereo mini jack (3.5mm) (Input impedance: 10kΩ, Input sensitivity: 200mV); USB port: micro B; PEDAL jack: Standard jack (6.3mm) (Pedal sustain, sostenuto, soft, start/stop)
- Power Jack:** 9.5VDC
- Power Supply:** 2-Way Power; 6 AA-size alkaline batteries or AA-size rechargeable nickel metal hydride batteries, Continuous operation: approximately 19 hours (alkaline batteries), approximately 15 hours (rechargeable nickel metal hydride batteries)*, actual battery life may be shorter depending on battery type, performance style, or operation environment; AD-E95100L AC adaptor (JEITA Standard, with unified polarity plug), 30-minute Auto Power Off (Can be disabled.)
- * Measured values while using eneloop batteries. eneloop is a trademark of Panasonic Corporation.
- Speakers:** 13 cm × 6 cm (oval) × 2 (Output: 2.5W+2.5W)
- Power consumption:** 9.5V --- 5.5W
- LCD:** Adjustable contrast
- Dimensions:** 93.0(W) × 25.6(D) × 7.3(H) cm (36 5/8 × 10 1/16 × 2 7/8 inch)
- Weight:** Approximately 3.3kg (7.3 lbs) (Excluding batteries)

Specifications and designs are subject to change without notice.

- Any reproduction of the contents of this manual, either in part or its entirety, is prohibited. Except for your own, personal use, any other use of the contents of this manual without the consent of CASIO is prohibited under copyright laws.
- IN NO EVENT SHALL CASIO BE LIABLE FOR ANY DAMAGES WHATSOEVER (INCLUDING, WITHOUT LIMITATION, DAMAGES FOR LOSS OF PROFITS, BUSINESS INTERRUPTION, LOSS OF INFORMATION) ARISING OUT OF THE USE OF OR INABILITY TO USE THIS MANUAL OR PRODUCT, EVEN IF CASIO HAS BEEN ADVISED OF THE POSSIBILITY OF SUCH DAMAGES.
- The contents of this manual are subject to change without notice.
- Company and product names used in this manual may be registered trademarks of others.

Declaration of Conformity

Model Number: CT-S300
Trade Name: CASIO COMPUTER CO., LTD.
Responsible party: CASIO AMERICA, INC.
Address: 570 MT. PLEASANT AVENUE, DOVER, NEW JERSEY 07801
Telephone number: 973-361-5400
This device complies with Part 15 of the FCC Rules, Operation is subject to the following two conditions:
(1) This device may not cause harmful interference, and (2) this device must accept any interference received, including interference that may cause undesired operation.

A labels rating is affixed to the bottom of the product.

CASIO COMPUTER CO., LTD.
6-2, Hon-machi 1-chome
Shibuya-ku, Tokyo 151-8543, Japan

Free Manuals Download Website

<http://myh66.com>

<http://usermanuals.us>

<http://www.somanuals.com>

<http://www.4manuals.cc>

<http://www.manual-lib.com>

<http://www.404manual.com>

<http://www.luxmanual.com>

<http://aubethermostatmanual.com>

Golf course search by state

<http://golfingnear.com>

Email search by domain

<http://emailbydomain.com>

Auto manuals search

<http://auto.somanuals.com>

TV manuals search

<http://tv.somanuals.com>