



Verify that you have the most current version of this document from www.hvacpartners.com, the **Carrier Partner Community** website, or your local Carrier office.

Important changes are listed in **Document revision history** at the end of this document.

©2022 Carrier. All rights reserved.



Contents

What is the TruVu™ ChillerVu™ Plant Controller?	1
Critical Product Announcement	2
Specifications	3
Zone sensors	6
Touchscreen devices	6
To mount the TV-PSM	7
To attach I/O expanders	9
TruVu MPC I/O expander configurations.....	9
To attach TruVu MPC I/O expanders.....	13
To attach MPC Open XPIO expanders	14
Wiring for power	15
To wire for power	15
Addressing the TV-PSM	16
Rotary switch settings.....	17
To set up autobaud.....	17
To set the IP address.....	18
To set the Port S1 address and baud rate	20
To set the Port S2 address and baud rate	20
Configuring BACnet Device Instance and network number.....	21
To set up BACnet Broadcast Management Devices (BBMDs)	22
Wiring for communications	25
Wiring specifications	25
To connect the TV-PSM to the Ethernet.....	26
To wire to a BACnet/ARCNET network.....	26
To wire to a BACnet MS/TP network	27
To wire a third-party device	27
Wiring devices to the TV-PSM's Rnet port	28
To communicate through the BACnet/IP Service Port network	29
Adjusting the TV-PSM driver properties	30
Driver	30
Device	32
Notification Classes.....	33
Calendars	34
Common and Specific Alarms	34
Custom Translation Tables.....	34
BACnet Router Properties	35
BACnet Firewall.....	35
Network Diagnostics - Statistics.....	35
Network Diagnostics - Packet Capture.....	36
I/O Bus and Xnet Expanders.....	38
Communication Status	40
To set up Network Statistic trends.....	40
To set up the controller through the Service Port	42
ModStat tab.....	42
Device tab	43
Ports tab.....	44
BACnet tab.....	45
Modbus tab.....	46
Security tab.....	46
To communicate locally through the Rnet port	47

Troubleshooting	48
LEDs	48
To get a Module Status report	50
To get a Device Log	50
To get the TV-PSM's serial number	51
To replace the TV-PSM's fuses	51
To take the TV-PSM out of service	52
Compliance	53
FCC Compliance	53
CE and UKCA Compliance	53
Industry Canada Compliance	53
BACnet Compliance	53
Appendix A: Module Status field descriptions	54
Appendix B: TV-PSM wire lists	56
TV-PSM wire list	56
MPC Open XPIO48 wire list	58
MPC Open XPIO816 wire list	60
Document revision history	63

The TV-PSM has 4 physical ports for BACnet or Modbus communication:

Port	Port type	For routing this type of communication...	At...
Gig-E	10/100/1000 Mbps Ethernet	BACnet/IP, BACnet/Ethernet, and/or Modbus TCP/IP	10, 100, or 1000 Mbps (1 Gbps)
S1	High-speed EIA-485 port	BACnet/ARCNET or BACnet/MSTP or Modbus Serial	156 kbps 9.6 to 115.2 kbps 9.6 to 115.2 kbps
S2	Electrically isolated EIA-485 port	BACnet/MSTP or Modbus Serial	9.6 to 115.2 Kbps 9.6 to 115.2 kbps
Service Port	10/100 Mbps Ethernet HTTP/IP	BACnet/IP Service Port	10 or 100 Mbps

NOTE The TV-PSM does not support CCN networks.

The TV-PSM also has the following ports:

- I/O Bus port for wired TruVu™ MPC I/O expanders
- I/O bus edge connector for directly-connected TruVu™ MPC I/O expanders
- Xnet port for MPC Open XPIO expanders
- Rnet port for ZS sensors, Wireless Adapter for wireless sensors, and an Equipment Touch
- USB port for recovery
- Ethernet Service Port for connecting locally to controller setup pages and the TruVu™ ET Display

Critical Product Announcement

Due to the global semiconductor supply chain uncertainty, the TV-PSM does not yet support communication over the ARCNET network. References to ARCNET in this document are for future use and should be ignored at this time.

The TV-PSM's driver properties and controller setup pages only show available communication selection options.

Specifications

Driver	drv_fwex_< version >.driverx
Maximum number of control programs*	999
Maximum number of BACnet objects*	12000
Third-party BACnet integration points	1500
Third-party Modbus integration points	1000
* Depends on available memory.	
Power	24 Vac \pm 10%, 50–60 Hz, 50 VA 26 Vdc \pm 10%, 15 W
I/O expanders	Supports up to 9 TruVu™ MPC I/O expanders and/or 6 MPC Open XPIO expanders, but no more than 9 expanders total.
Gig-E port	10/100/1000 BaseT, full duplex, Ethernet port for BACnet/IP and/or BACnet/Ethernet, or Modbus TCP/IP communication.
Port S1	For communication with either of the following: <ul style="list-style-type: none"> • A BACnet ARCNET network at 156 kbps • A BACnet MS/TP network at 9600 to 115200 bps • A Modbus serial network at 9600 to 115200 bps This port's End of Net? switch can be set to Yes to terminate the network segment.
Port S2	For communication with either of the following: <ul style="list-style-type: none"> • A BACnet MS/TP network at 9600 to 115200 bps • A Modbus serial network at 9600 to 115200 bps This port's End of Net? switch can be set to Yes to terminate the network segment.
Rnet port	<ul style="list-style-type: none"> • Supports Up to 15 ZS wireless and/or ZS sensors, and one Equipment Touch or TruVu™ ET Display • Supports local connection for a laptop running the i-Vu® application • Supplies 12 Vdc/62.5 mA power across its rated temperature range. NOTE Ambient temperature and power source fluctuations may reduce the power supplied by the Rnet port. <p>NOTE If the total power required by the sensors on the Rnet exceeds the power supplied by the Rnet port, use an external power source. The Wireless Adapter, Equipment Touch, or TruVu™ ET Display must be powered by an external power source. See the specifications in each device's Installation and Start-up Guide to determine the power required.</p>
I/O Bus port	Provides communication for a wired TruVu™ MPC I/O expander that is powered by an external power supply. See <i>TruVu™ MPC I/O expander configurations</i> (page 9) to determine how many TruVu™ MPC I/O expanders you can connect to this port.
I/O bus edge connector	6-pin connector that provides communication and power to a directly-connected TruVu™ MPC I/O expander. See <i>TruVu™ MPC I/O expander configurations</i> (page 9) to determine how many TruVu™ MPC I/O expanders you can use with the edge connector.
Xnet port	For communication with up to 6 MPC Open XPIO expanders powered by an external power supply.

Service Port	Ethernet port at 10 or 100 Mbps for setting up the controller and troubleshooting through a local connection to a computer or connecting to the TruVu™ ET Display
USB port	USB 2.0 host port for device recovery
Microprocessor	32-bit ARM Cortex-A8, 600MHz, processor with multi-level cache memory
Memory	16 GBs eMMC Flash memory and 256 MB DDR3 DRAM (22 MB available to use). User data is archived to non-volatile Flash memory when parameters are changed, every 90 seconds, and when the firmware is deliberately restarted. NOTE When you change a parameter, you must wait 30 seconds before turning the power off, in order for the change to be saved.
Real-time clock	Real-time clock keeps track of time in the event of a power failure for up to 3 days.
Protection	The TV-PSM has two fast acting, 5mm x 20mm glass fuses: <ul style="list-style-type: none"> • A 2A fuse for the TV-PSM's power • A 4A fuse for the I/O bus edge connector <p>The power and network ports comply with the EMC requirements EN50491-5-2.</p> <p> CAUTION To protect against large electrical surges on serial EIA-485 networks, place a PROT485 at each place wire enters or exits the building.</p>
LED status indicators	<ul style="list-style-type: none"> • Tricolor Net LED to show network status • Tricolor Sys LED to show system status • A Tx (Transmit) and Rx (Receive) LED for the following ports: <ul style="list-style-type: none"> ○ Gig-E ○ I/O Bus ○ Port S1 ○ Port S2 ○ Xnet ○ Rnet <p>See <i>LEDs</i> (page 48).</p>
Environmental operating range	-40 to 158 °F (-40 to 70 °C), 10-95% relative humidity, non-condensing NOTES <ul style="list-style-type: none"> • The TV-PSM is suitable for installation inside or outside the building envelope. • Install in a UL Listed enclosure only. • Do not change the position of the power or End of Net switch at temperatures below -22 °F (-30C) to ensure proper operation and electrical connectivity.
Physical	Fire-retardant plastic ABS, UL94-5VA
Terminal blocks and connectors	Screw-type terminal blocks. 0.2 in (5.08 mm) pitch connectors
Mounting	35mm DIN rail mounting or screw mounting

Overall dimensions	A: 7.1 in. (18.03 cm) B: 6.95 in. (17.65 cm) Depth: 2.09 in. (5.31 cm)	
Screw mounting dimensions	C: 6.45 in. (16.38 cm) D: 4.1 in. (10.4 cm)	
Weight	1 lb. (0.45 kg)	
BACnet support	Conforms to the BACnet Building Controller (B-BC) Standard Device Profile as defined in ANSI/ASHRAE Standard 135-2012 (BACnet) Annex L, Protocol Revision 14	
Compliance	<p>United States of America: FCC compliant to Title CFR47, Chapter 1, Subchapter A, Part 15, Subpart B, Class A; UL Listed to UL 916, PAZX, Energy Management Equipment</p> <p>Canada: Industry Canada Compliant, ICES-003, Class A cUL Listed UL 916, PAZX7, Energy Management Equipment</p> <p>Europe: Mark, UK: EN50491-5-2:2009; Part 5-2: EMC requirements for HBES/BACS used in residential, commercial and light industry environment RoHS Compliant: 2015/863/EU REACH Compliant</p> <p>Australia and New Zealand: C-Tick Mark, AS/NZS 61000-6-3</p>	

Zone sensors

You can wire ZS sensors and/or a Wireless Adapter that communicates with wireless sensors to the TV-PSM's Rnet port. You can have up to 15 ZS and/or wireless sensors.

NOTES

- A control program can use no more than 5 ZS sensors, so you must use multiple control programs if your Rnet network has more than 5 sensors.
- ZS and wireless sensors can share the Rnet with an Equipment Touch or TruVu™ ET Display.



CAUTION Rnet power

The Rnet port provides 12 Vdc at 62.5 mA maximum that can be used to power zone sensors. When determining which devices to put on the Rnet, verify that the total current draw of the sensors does not exceed the controller's Rnet power. See the sensor's *Installation and Start-up Guide* to determine the power required.

Touchscreen devices

You can connect the TruVu™ ET Display to the TV-PSM's Ethernet Service port to view or change the controller's driver properties. You can also create a custom Touch file to provide a graphic representation of the controlled equipment or to provide access to schedules, view trends and alarms, and more without having to access the system's server.

NOTES

- These touchscreen devices are not powered by the Ethernet port.
- The TruVu™ ET Display requires a 24 Vdc external power source.



CAUTION A touchscreen device can share a power supply with the Carrier controller if:

- The power source shared by the controller and Equipment Touch is AC power.
- The power source shared by the controller and TruVu™ ET Display is DC power.
- You maintain the same polarity.
- You use the power source only for Carrier controllers.

To mount the TV-PSM

The TV-PSM can be mounted on a DIN rail or screwed to a surface.

NOTE We recommend screw mounting when installing in a high temperature and high humidity environment.

DIN rail mount

- 1 Push down and pull out the center tabs shown below to clear the DIN rail trough on the back of the controller.

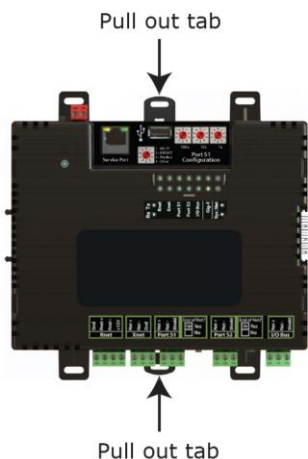

- 2 Place the controller on the DIN rail so that the rail is in the trough on the back of the controller.

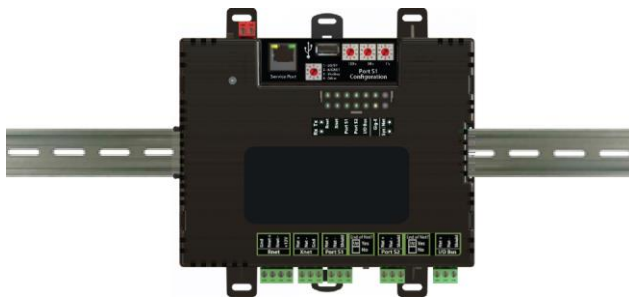

- 3 Push the center tabs towards the controller until you hear them click.
- 4 Pull gently on the controller to verify that it is locked in place.

To mount the TV-PSM

Screw Mount

Leave about 2 in. (5 cm) on each side of the controller for wiring.

Insert #6 screws through the mounting tabs. Use no more than 8 in.lbs. torque to secure plastic tab to mounting surface.

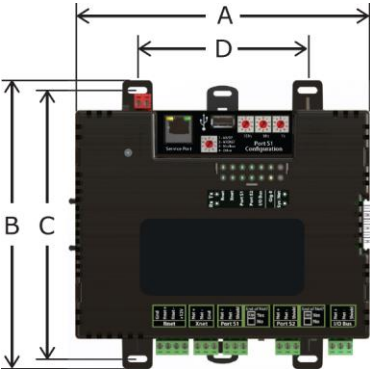

- A: 7.1 in. (18.03 cm)
- B: 6.95 in. (17.65 cm)
- C: 6.45 in. (16.38 cm)
- D: 4.1 in. (10.4 cm)
- Depth: 2.09 in (5.31 cm)

To attach I/O expanders

To add inputs or outputs to the TV-PSM, you can attach up to 9 TruVu™ MPC I/O expanders and/or 6 MPC Open XPIO expanders, but no more than 9 expanders total. Each expander must have a unique address (1 through 9) set on its rotary switch. An MPC Open XPIO expander's address must be in the range from 1 to 6.

See:

TruVu™ MPC I/O expander configurations (page 9)

To attach TruVu™ MPC I/O expanders (page 13)

To attach MPC Open XPIO expanders (page 14)

The expander's Installation and Start-up Guide

TruVu MPC I/O expander configurations

The expanders' outputs return to their unconfigured state if they are removed from the program or the program is deleted from the controller. Also, outputs time out and return to their unconfigured or off state after two minutes of inactivity. The unconfigured state results in:

- Not running control programs that are due to download
- Losing power to the controller, but not the expander

NOTE This does not apply to outputs that have been locked in the i-Vu® application.

The TruVu™ MPC I/O expander can be connected to the TV-PSM in one of the following ways:

- Directly-connected to the I/O bus edge connector that provides power and communication

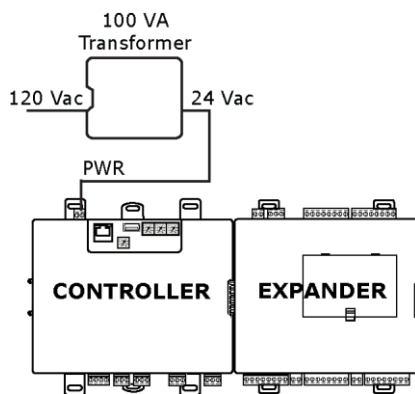

To attach I/O expanders

- Wired to the I/O Bus port for communication and then wired to an external transformer for power

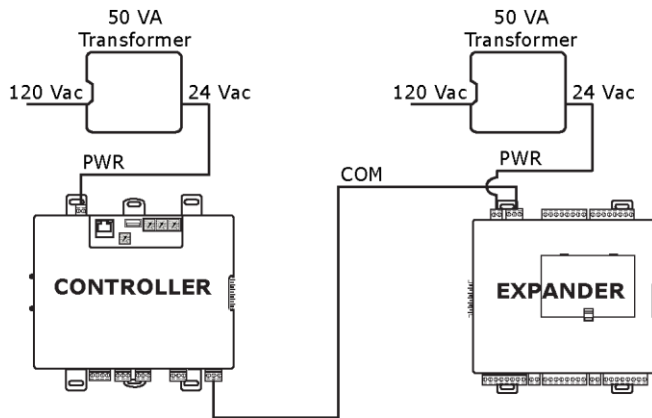

The connection/wiring configuration that you use depends on:

- The number of TruVu™ MPC I/O expanders you need
- Whether you use AC or DC power supply
- The size of the power supply

NOTE The controller has built-in I/O bus network termination and must be the first device on the expander network. Add termination to the last TruVu™ MPC I/O expander on the network by setting I/O Bus **End of Net?** switch to **Yes** (Up).



WARNING Do not apply line voltage (mains voltage) to the controller's ports and terminals.



CAUTIONS

- The TV-PSM is powered by a Class 2 power source. Take appropriate isolation measures when mounting it in a control panel where non-Class 2 circuits are present.
- Carrier controllers can share a power supply as long as you:
 - Maintain the same polarity.
 - Use the power supply only for Carrier controllers.

Using AC power

The controller and the TruVu™ MPC I/O expander each draw 50 VA. The following images are two possible configurations when using AC power, but many more configurations exist depending on the size of the transformers (50 or 100 VA) and the number of TruVu™ MPC I/O expanders you have.

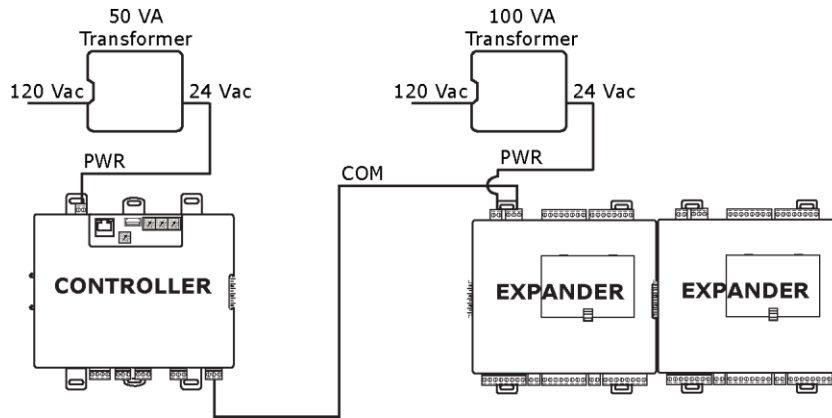

The following configuration shows a combination of connections using the I/O bus edge connector and daisy-chained wiring to the I/O Bus ports.

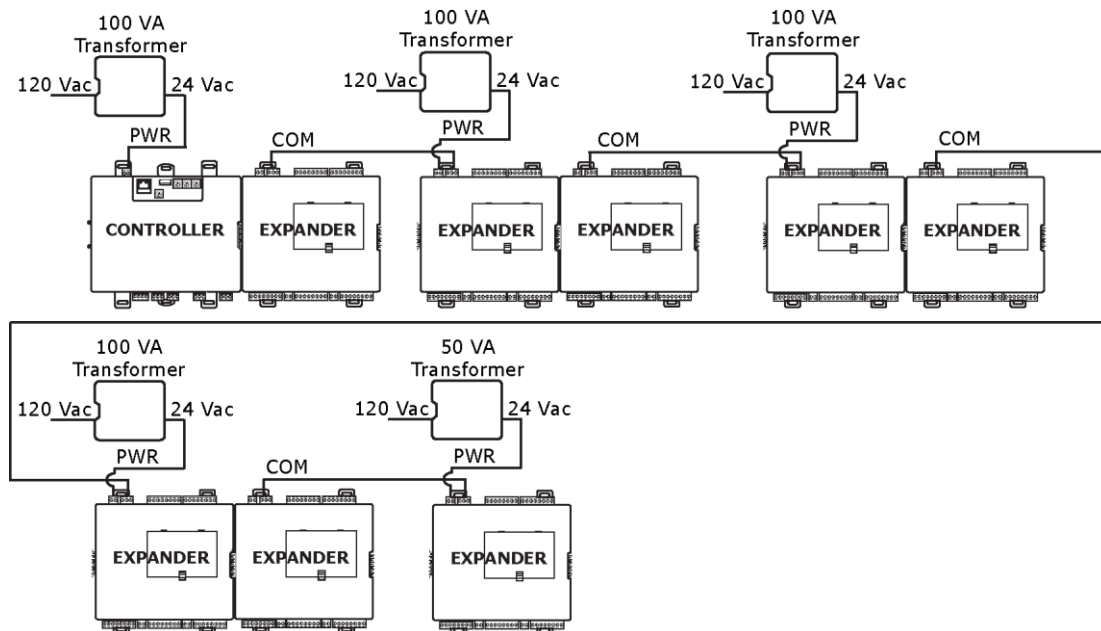

To attach I/O expanders

Using DC power

The controller draws 15 W and the TruVu™ MPC I/O expander draws 12 W. In the following image, the 100 W power supply can supply power to one controller and 7 expanders. The TruVu™ MPC I/O expanders are connected to the controller and to each other using the I/O bus edge connector that provides power and communication. The configuration also shows a combination of connections using the edge connector and wiring to the I/O Bus ports.

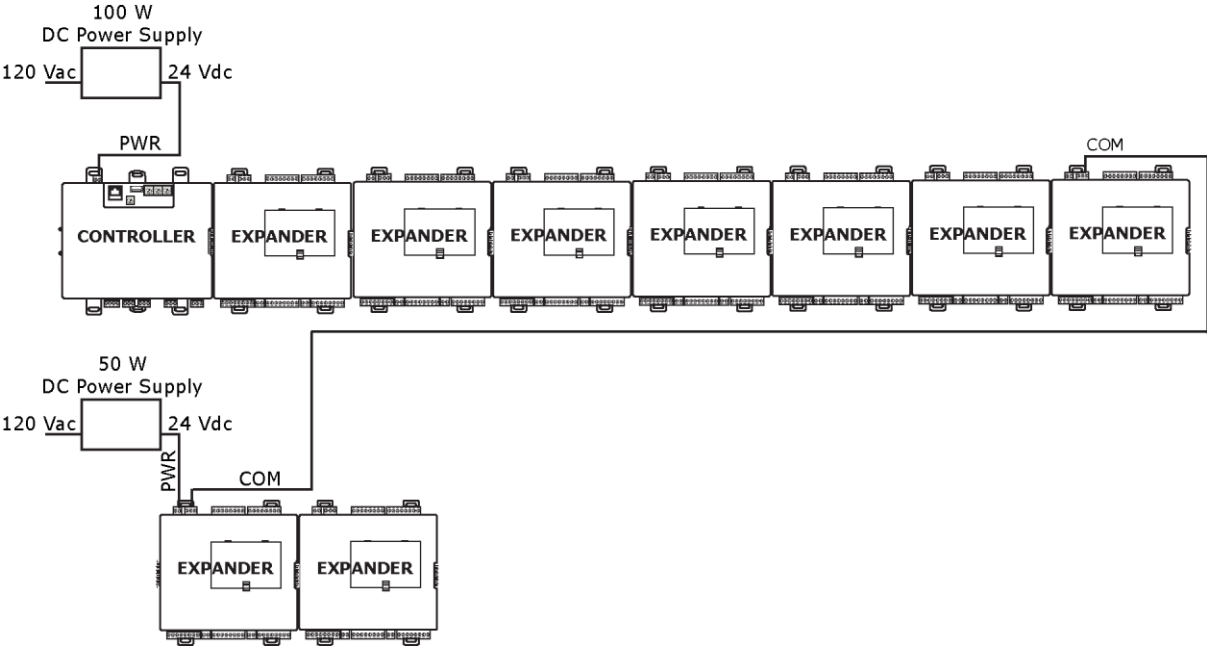

To attach TruVu MPC I/O expanders

A TruVu™ MPC I/O expander can be directly-connected to the TV-PSM's I/O bus edge connector or wired to the TV-PSM's **I/O Bus** port.

To connect the TruVu™ MPC I/O expander to the I/O bus edge connector

NOTE The following instructions assume that the controller is already mounted either on a DIN rail or using screws.

- 1 Turn **off** the TV-PSM's power.
- 2 Remove the plastic protective cap from the TV-PSM's I/O bus edge connector and the expander's edge connector. Squeeze the plastic tabs to pull the cap off.

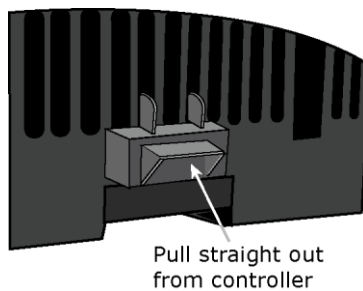

⚠ WARNING This connector provides power and communication. To prevent risk of shock, do not touch the bare edge connector if the controller's power is on.

- 3 DIN rail mounting only—Push down and pull out the expander's center tabs shown below.

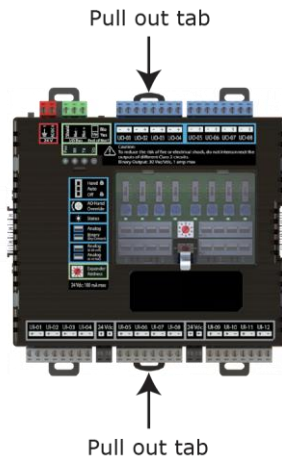

- 4 Slide the expander's left edge connector down onto the TV-PSM's edge connector.
- 5 Do one of the following:
 - DIN rail mounting—Push in the expander's center tabs towards the expander until you hear them click. Pull gently on the expander to verify that it is locked to the DIN rail.
 - Screw mounting—Insert #6 screws through the expander's mounting holes.
- 6 Optional: If using DC power, you may connect additional TruVu™ MPC I/O expanders in the same manner described above. See the diagrams in *TruVu™ MPC I/O expander configurations* (page 9).

To wire the TruVu™ MPC I/O expander to the I/O Bus port

Use a 22 AWG, low-capacitance, twisted, stranded, shielded copper wire to wire the TruVu™ MPC I/O expander to the controller. Do not exceed 1000 feet (305m) total wire length for the I/O bus.



WARNING Do not apply line voltage (mains voltage) to the expander's ports and terminals.

- 1 Turn off the controller's and expander's power.
- 2 Wire the expander's **I/O Bus** port to the same port on the controller.

NOTES

- To use more than one expander, wire their **I/O Bus** ports together in a daisy-chain configuration. The controller must be the first device on the expander network.
 - Use the same polarity throughout the network segment.
- 3 On the last expander on the I/O bus, set the I/O Bus **End of Net?** switch to **Yes** to apply network termination and bias.

NOTE The controller has built-in I/O bus network termination and must be the first device on the expander network.

- 4 Mount the TruVu™ MPC I/O expander to a DIN rail or using screws as described in steps 3 and 5 above.
- 5 Turn on the controller's and expander's power.

To attach MPC Open XPIO expanders

Use a 22 AWG, low-capacitance, twisted, stranded, shielded copper wire to wire the MPC Open XPIO expander to the controller. Do not exceed 100 feet total wire length. See the *Open Controller Network Wiring Guide* for complete wiring specifications.

Wire the TV-PSM's **Xnet** port to the MPC Open XPIO expander's **Xnet Remote Expansion** port. To use more than one expander, wire their **Xnet Remote Expansion** ports together in a daisy-chain configuration.

The TV-PSM has built-in Xnet termination and must be the first device on the expander network. Add termination to the last MPC Open XPIO expander by placing the **Term** jumper (if provided) in the up position. If the MPC Open XPIO expander does not have a **Term** jumper, you must add external network termination.

NOTE You must set the Xnet baud rate to 500 kbps in the i-Vu® interface on the driver's **I/O Bus and Xnet Expanders** page. See *Adjusting TV-PSM driver properties* (page 30).

Wiring for power

WARNING Do not apply line voltage (mains voltage) to the controller's ports and terminals.

CAUTIONS

- The TV-PSM is powered by a Class 2 power source. Take appropriate isolation measures when mounting it in a control panel where non-Class 2 circuits are present.
- Carrier controllers can share a power supply as long as you:
 - Maintain the same polarity.
 - Use the power supply only for Carrier controllers.

To wire for power

- 1 Make sure the TV-PSM's power switch is in the **OFF** position to prevent it from powering up before you can verify the correct voltage.

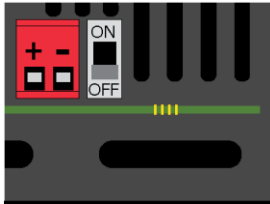

- 2 Remove power from the power supply.
- 3 Pull the red screw terminal connector from the controller's power terminals labeled **24 Vac/Vdc (+/-)**.
- 4 Connect the power supply's wires to the red screw terminal connector.
- 5 Connect an 18 AWG or larger wire from the power supply's negative (-) terminal to earth ground. This wire must not exceed 12 in. (30.5 cm).
- 6 Apply power to the power supply.
- 7 Measure the voltage at the red screw terminal connector to verify that the voltage is within the operating range of 20 to 30 Vac or 23.4 to 30 Vdc.
- 8 Insert the red screw terminal connector into the controller's power terminals.
- 9 To verify the polarity of the wiring, measure the voltage from the negative terminal of the red screw terminal connector to a nearby ground. The reading should be 0V.
- 10 Turn on the expander's power switch.
- 11 Verify that the  LED on top of the controller is on.
- 12 Measure the voltage at the red screw terminal connector to verify that the voltage is within the operating range of 20 to 30 Vac or 23.4 to 30 Vdc.

Addressing the TV-PSM

Set this port's address ...	In this location...	See...
IP	Service Port	To set the IP address (page 18)
Port S1	On the controller's rotary switches	To set the Port S1 address and baud rate (page 20)
Port S2	Service Port	To set the Port S2 address and baud rate (page 20)

To access the controller setup through the **Service Port**:

- 1 Connect an Ethernet cable from a computer to the controller as shown below.

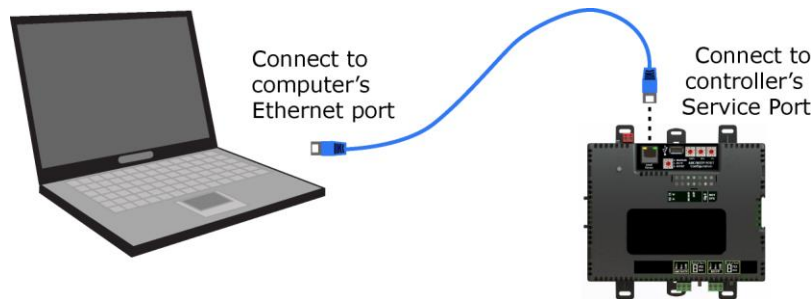

- 2 Turn off the computer's Wi-Fi if it is on.
- 3 If your computer uses a static IP address, use the following settings:
 - o Address: 169.254.1.x, where x is 2 to 7
 - o Subnet Mask: 255.255.255.248
 - o Default Gateway: 169.254.1.1
- 4 If it uses a DHCP address, leave the address as it is.
- 5 Open a web browser on the computer.
- 6 Navigate to <http://local.access> or <http://169.254.1.1> to see the Service Port controller setup pages.

See *To set up the controller through the Service Port* (page 42) for general information on using the controller setup pages.

Rotary switch settings

Rotary switch settings (see example below) are used to determine the following items in your system, so you should plan carefully before setting the switches.

- If you use a **Default IP address**, the final octet is the number created by the three rotary switch settings (must be a unique number from 1 to 253). See *To set the IP address* (page 18).
- If you autogenerate the following:
 - Device Instance**, the number is automatically set to a number equal to the ((IP network number x 100) + rotary switch settings).
 - BACnet Network Number** for Port S1, the number is automatically set to a number equal to the ((IP network number + rotary switch settings) x 10).

Autogenerating is set up through the *controller setup pages* (page 42).
- The rotary switch settings determine the router number in the i-Vu® interface.

EXAMPLE The switches below are set to 125.

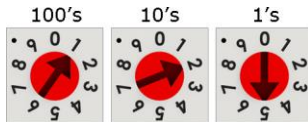

CAUTION Do not leave the rotary switches set at 0 (the factory default). The TV-PSM cannot be discovered if the rotary switches are left at 0.

To set up autobaud

The TV-PSM can automatically receive or establish the baud rate on a serial network. When you configure a device on the network for autobaud and then power it up, the device detects the incoming baud rate on the network and sets its baud to match.

Autobaud does not work unless there is a device on the network, whether Carrier or third party, that has the baud rate already set. You can manually set the baud rate on more than one device, as long as the rate is the same for every device.

NOTES

- The received baud rate stays intact during power cycles.
- We recommend you set the baud rate manually on the router for the network.

MS/TP

MSTP Autobaud can be configured in either the:

- **Service Port** controller setup pages > **BACnet** tab > **Port S1** or **Port S2**
or
- The i-Vu® interface, right-click your TV-PSM on the navigation tree, and select **Driver Properties** > **BACnet Router Properties** > **MS/TP Configuration** on Port S1 or on Port S2. See *BACnet Router Properties* (page 35).

Modbus

Modbus Serial Autobaud can be configured in either the:

- **Service Port** controller setup pages > **Modbus** tab > **Modbus RS-485** > **Port Configuration**
or
- The i-Vu® interface, right-click your TV-PSM on the navigation tree, and select to **Driver Properties** > **Communication Status** > **Modbus Serial**

NOTE See the *Modbus Integration Guide*.

NOTE If you set **Autobaud** or make other changes in the controller setup pages, you must upload the changes to the system database the first time you access the controller in the i-Vu® interface. This preserves those settings when you download memory or parameters to the controller.

To set the IP address

You must define the TV-PSM's IP addressing (IP address, subnet mask, and default gateway) in the Service Port controller setup pages so that the controller can communicate with the i-Vu Server on the IP network.

Use one of the IP addressing schemes described below with the associated instructions that follow.

Use a...	If...
DHCP IP Address generated by a DHCP server	The IP network uses a DHCP server for IP addressing
Custom Static IP Address from your network administrator	You do not use a DHCP server and the answer to any of the following questions is yes. Will the i-Vu® system: <ul style="list-style-type: none"> • Share a facility's existing IP data network? • Have 254 or more devices with static IP addresses? • Be connected to the Internet? • Have at least one device located on the other side of an IP router? • Have any third-party IP devices?
Default IP Address that your system creates	The answer to all of the above questions is no.

NOTE Carefully plan your addressing scheme to avoid duplicating addresses. If third-party devices are integrated into the system, make sure your addresses do not conflict with their addresses.

To set a DHCP IP address

- 1 On the controller setup **Modstat** tab, find the controller's **Ethernet MAC address** and write it down.
- 2 On the **Ports** tab under **IP Port**, select **DHCP**.
- 3 Click **Save**.
- 4 Write down the **IP Address**.
- 5 Give the DHCP network administrator the IP address and Ethernet MAC address and ask him to reserve that IP address for the controller so that it always receives the same IP address from the DHCP server.

To set a custom IP address

- 1 Obtain the IP address, subnet mask, and default gateway address for the controller from the facility network administrator.
- 2 On the controller setup **Ports** tab under **IP Port**, select **Custom Static**.
- 3 Enter the **IP Address**, **Subnet Mask**, and **Default Gateway** addresses that the network administrator gave you.
- 4 Click **Save**.

To set a default IP address

Default IP addressing assigns the following to the controller:

- IP address = 192.168.168.**x**
where **x** is the setting on the rotary switches in the range from 1 to 253
- Subnet Mask = 255.255.255.0
- Default Gateway = 192.168.168.254

- 1 Set the controller's three rotary switches to a unique address on the network. Set the left rotary switch to the hundreds digit, the middle switch to the tens digit, and the right switch to the ones digit.

EXAMPLE The switches below are set to 125.

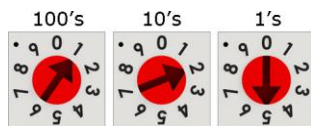

- 2 On the controller setup **Ports** tab under **IP Port**, select **Default IP Address**.
- 3 Click **Save**.

CAUTIONS

- The Default IP address range is 1 to 253. Setting the rotary switches to 0 will set the Default IP address to 1. Setting the switches to 255 will set the Default IP to 253. Do not set the switches to 254.
- If you set the Default IP address on the controller setup **Ports** tab and then change the rotary switches, you must do one of the following to correct the IP address in the controller:
 - Go to the controller setup **Ports** tab and click the **Update IP Address**.
 - Cycle the controller's power.

You will then need to correct the IP address in the i-Vu® application using **Find Devices** and **Upload All Content**. See the i-Vu® Help for more information.

NOTE The default address is an intranet address. Data packets from this address are not routable to the Internet.

To set the Port S1 address and baud rate

The address should be in one of the following ranges based on the port's use.

Port address

- For ARCNET, the range is 1 to 254.
- For MS/TP, the range is 0 to 127.
- For Modbus, the range is 1 to 247.

For MS/TP, set up autobaud or the port's baud rate

- 1 On the controller setup **BACnet** tab under **Port S1**, select the **MSTP Baud Rate** or select **Yes** for **MSTP Autobaud**. The default is 76,800 bps.

NOTES

- See *To set up autobaud* (page 17) for details.
 - If not using autobaud, enter the identical baud rate for all devices on the same MS/TP network segment.
- 2 Click **Save**.

Modbus

For Modbus, see the *Modbus Integration Guide*.

To set the Port S2 address and baud rate

For MS/TP, set up autobaud or the port's baud rate

- 1 On the controller setup **BACnet** tab under **Port S2**, type the address in the **MSTP Address** field. The address must be in the range 0 to 127.
- 2 Select the **MSTP Baud Rate** or select **Yes** for **MSTP Autobaud**. The default is 76,800 bps.

NOTES

- See *To set up autobaud* (page 17) for details.
 - If not using autobaud, enter the same baud rate for all devices on the MS/TP network.
- 3 Click **Save**.

Modbus

For Modbus, see the *Modbus Integration Guide*.

Configuring BACnet Device Instance and network number

The TV-PSM controller must have a unique Device Instance and Name. These BACnet addresses are automatically generated and usually do not require modification. However, sometimes you need to override the automatic addressing assignments.

Autogenerated addressing scheme:

The TV-PSM's rotary address setting determines the automatic BACnet addressing scheme for the connected Open network.

Legend

16 = Carrier's BACnet Vendor ID

xxx = TV-PSM's rotary switch address (See NOTES below.)

yy = Controller's rotary switch address (ARCNET/MSTP MAC address)

For the TV-PSM:

- BACnet Device Instance Number = (IP network number x 100) + rotary switch address
- BACnet Device Instance Name = the name "device" + the Device Instance
- BACnet IP Network Number = 1600
- BACnet ARC/MSTP Port S1 Network Number = ((IP network number + rotary switch address) x 10)
- Port S1 MSTP MAC Address = 0 by default (user configurable)
- Port S1 ARCNET Address = 254 by default (user configurable)
- BACnet MSTP Port S2 Network Number = ((IP network number + rotary switch address) x 10) + 3
- Port S2 MSTP MAC Address = 0 by default (user configurable)

For the Open controllers connected to the TV-PSM

- BACnet MSTP Device Instance Number = BACnet MSTP Network Number + yy
- BACnet ARCNET Device Instance Number = BACnet ARCNET Network Number + yy
- BACnet MSTP Device Instance Name = the name "device" + Device Instance
- BACnet ARCNET Device Instance Name = the name "device" + Device Instance
- BACnet MSTP or ARCNET MAC Address = yy
- BACnet MSTP Network Number = 161xx (learned from the router, defaults to 16101 if no TV-PSM is operating)

NOTES

- Do not configure the rotary switches on the TV-PSM to a number greater than 127 unless Port S1 is enabled for ARCNET. Doing so will not allow the i-Vu® server to discover the TV-PSM. If you change the TV-PSM's switches or jumpers, you must cycle its power for the changes to take effect.
- If the BACnet automatic settings need to be changed, see *To communicate through the Local Access port* (page 42).

To set up BACnet Broadcast Management Devices (BBMDs)

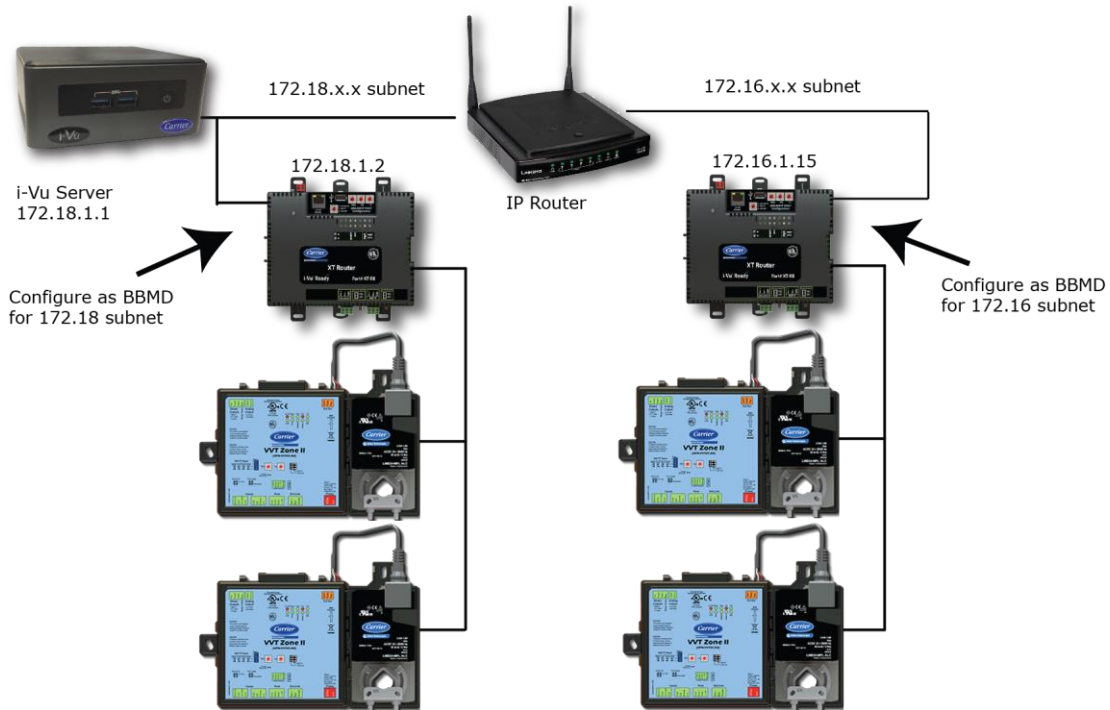

If your system has multiple routers that reside on different IP subnets, you must set up one router on each IP subnet as a BACnet/IP Broadcast Management Device (BBMD).

Every subnet with a router must have a BBMD configured in order for broadcasts from routers on that subnet to reach the rest of the routers on the network.

NOTES

- The i-Vu® Standard or Plus application - If the i-Vu® web server is on a separate subnet than the rest of the routers, the internal router must be assigned a routable IP address and configured as a BBMD.
- The i-Vu® Pro application - If the i-Vu® Pro server is on a separate subnet than the rest of the routers, you must register it as a foreign device to a router acting as a BBMD device.

Use the **BBMD Configuration Tool** to:

- Write/read the **Broadcast Distribution Table** (BDT) of each BBMD device
- Allow controllers on one subnet to communicate with controllers on other subnets
- Enable the i-Vu® application to see, upload, or configure controllers on different subnets

To set up BBMDs using the BBMD Configuration Tool

- 1 Assign an IP address, subnet mask, and default gateway for each TV-PSM on the IP network. See *Addressing the TV-PSM* (page 16).
- 2 Acquire the **BBMD Configuration Tool** from the Tech Tools USB drive or from either of the *Carrier Control Systems Support Sites* <http://www.hvacpartners.com/>. This is a stand-alone executable file and no installation is necessary.
- 3 Make a list of the IP addresses for each router that will function as a BBMD in your system.

In the above illustration, the Carrier router, address 172.18.1.2, must be configured as a BBMD for the 172.18 subnet, while the Carrier router, address 172.16.1.15, must be configured as a BBMD for the 172.16 subnet.



CAUTIONS

- Define only one BBMD per subnet. Multiple BBMDs on an IP subnet disrupt network communications.
 - Unless explicitly modified, the UDP Port for BACnet/IP is 0xBACO (47808). Do not change this parameter unless you made a change in the router.
- 4 In a text editor such as Notepad, create a list of the routers that will be BBMDs. List each IP address on a separate line. (Maximum of 50 IP addresses per file)

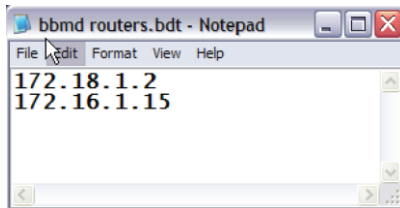

- 5 Save the file to your folder of choice with a .bdt, .bbmd, or .text extension instead of .txt.
- 6 Open the **BBMD Configuration Tool**.
- 7 In the **IP Address** or **Host Name** field, type the IP address of the router that functions as the BBMD (BACnet Broadcast Management Device) for its subnet.
- 8 To check if the router has an existing BBMD table, click the **Broadcast Distribution Table Read** button.
- 9 If the **Broadcast Distribution Table** contains IP addresses that are not in your file, verify that they are valid BBMDs and, if so, add them to your file.

NOTES

- The BDTs in each BBMD should be identical. Repeat this entire process whenever a BBMD is added.
 - If needed, disable the checkbox next to **Show Broadcast** to limit the amount of scrolling text that is displayed.
- 10 Click the **Broadcast Distribution Table Browse** button and select the file that you made in step 4.
 - 11 Verify that the appropriate IP address is still in the **IP Address** or **Host Name** field.
 - 12 Click the **Broadcast Distribution Table Write** button.
 - 13 Click **Read** again to verify that the new file was written to the router. See example below.

NOTE If you have a large BDT, you may have to re-size the **BBMD Configuration Tool** window to see the **Broadcast Distribution Table**.

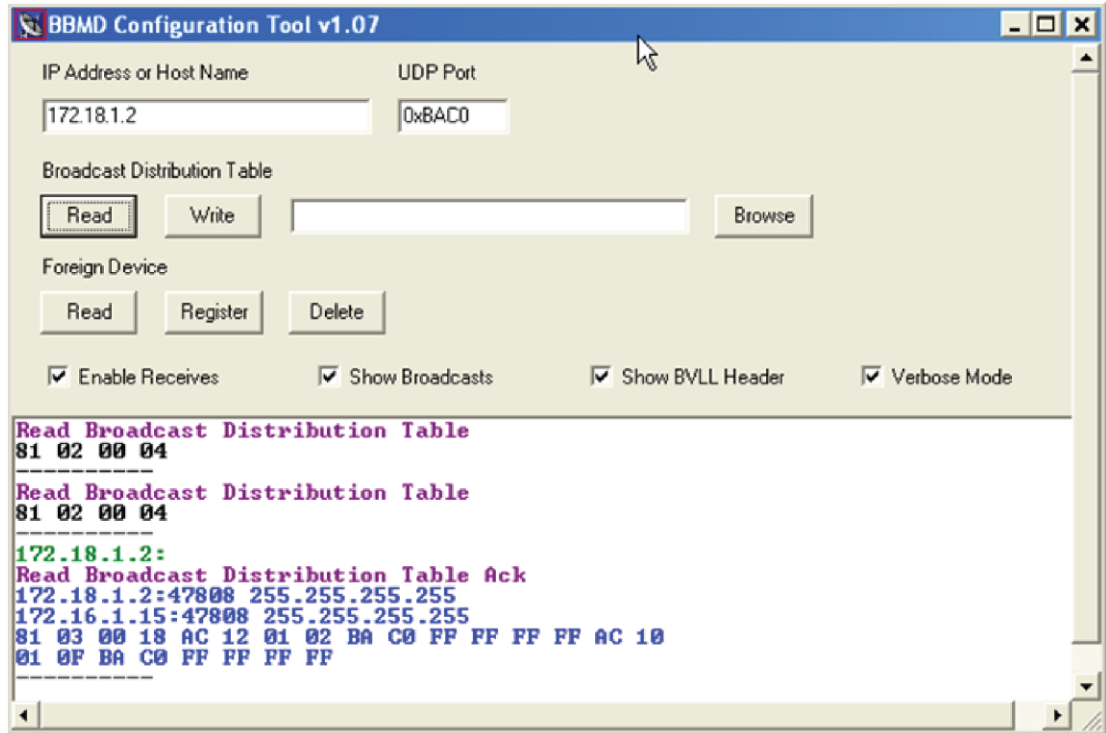

- Using the next IP address in the file, repeat steps 7 through 14 until every file has been updated.

NOTE To clear the BBMD entries from a router, follow the steps above using an empty (blank) file. A cleared BBMD table contains just the router's IP address without entries in the BBMD table, as shown below.

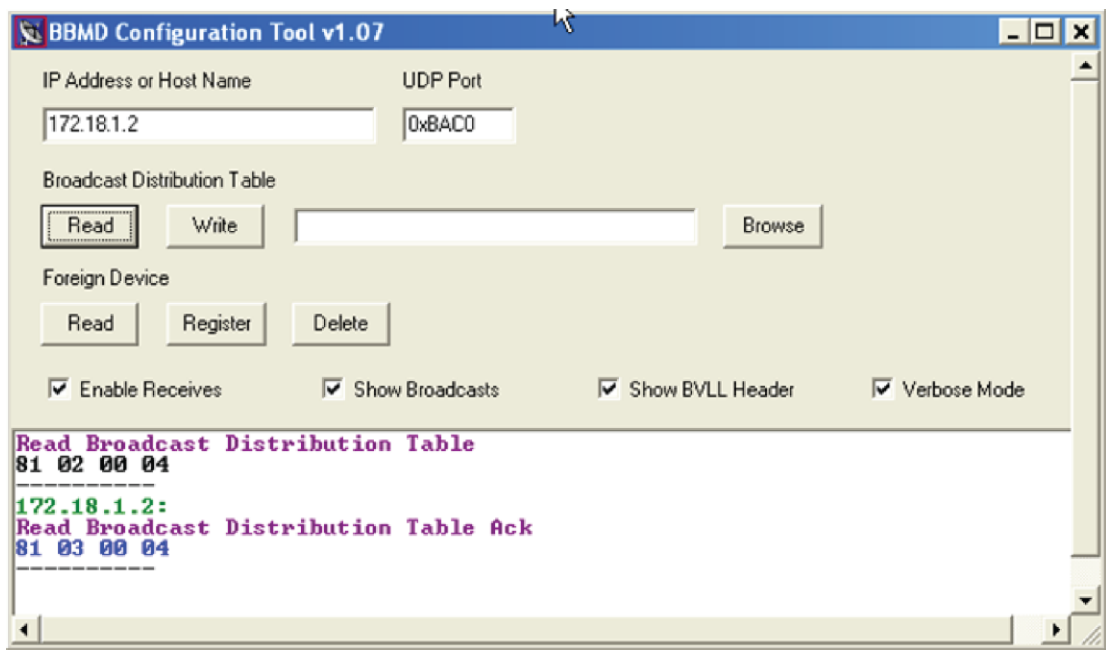

Wiring for communications

The TV-PSM communicates on the following ports.

Port	Protocol	Port type(s)	Speed(s)
Gig-E	BACnet/IP BACnet/Ethernet Modbus TCP/IP	Ethernet	10, 100, or 1000 Mbps (1 Gbps)
Port S1 ¹	BACnet/ARCNET	EIA-485	156 kbps
Port S1 ¹ or Port S2	BACnet/MSTP Modbus Serial	EIA-485	9.6 to 115.2 kbps ² 9.6 to 115.2 kbps ²
Service Port ³	HTTP/IP	Ethernet	10 Mbps 100 Mbps
USB Port	USB 2.0	USB	
Rnet Port	See <i>Wiring devices to the TV-PSM's Rnet port</i> (page 28).		
I/O Bus Port	See <i>To attach TruVu™ MPC I/O expanders</i> (page 13).		
Xnet Port	See <i>To attach MPC Open XPIO expanders</i> (page 14).		

¹ Set the **Port S1 Configuration** rotary switch to:

- 0** if port is not used
- 1** for MS/TP
- 2** for ARCNET
- 3** for Modbus
- NOTE 4** is for future use.

² Default for MS/TP is 76.8 kbps.
Default for Modbus is 38.4 kbps.

³ See *To set up the controller through the Service Port* (page 42).

Wiring specifications

For...	Use...	Maximum Length
BACnet/IP Ethernet	Cat5e or higher Ethernet cable	328 feet (100 meters)
MS/TP* ARCNET*	22 AWG, low-capacitance, twisted, stranded, shielded copper wire *	2000 feet (610 meters)

* For details see the *Open Controller Network Wiring Guide*.



WARNING Do not apply line voltage (mains voltage) to the controller's ports and terminals.

To connect the TV-PSM to the Ethernet

Connect an Ethernet cable to the Gig-E Ethernet port.

NOTE If your system has controllers on different IP subnets separated by an IP router, you must configure one controller on each subnet as a BACnet Broadcast Management Device (BBMD). Do not configure more than one BBMD per subnet as this may cause circular routes. See *To set up BACnet Broadcast Management Devices (BBMDs)* (page 22).

To wire to a BACnet/ARCNET network

- 1 Turn **off** the TV-PSM's power.
- 2 Check the communications wiring for shorts and grounds.
- 3 Connect the communications wiring to **Port S1**'s screw terminals labeled **Net +**, **Net -**, and **Shield**.
NOTE Use the same polarity throughout the network segment.
- 4 If the controller has a **Port S1 Configuration** rotary switch, set it to 2.
- 5 If the TV-PSM is at either end of a network segment, set the port's **End of Net** switch to **Yes**.
NOTE The controller's **End of Net** switch applies network termination and bias. See the *Open Controller Network Wiring Guide*.
- 6 Turn on the controller's power.
- 7 To verify communication with the network, get a Module Status report in the i-Vu® interface for a controller on the ARCNET network.
NOTE This step requires that you have discovered and uploaded the controller in the i-Vu® application.

To wire to a BACnet MS/TP network

An MS/TP network can be wired to either **Port S1** or **Port S2**.

- 1 Turn **on** the TV-PSM's power.
- 2 Check the communications wiring for shorts and grounds.
- 3 Connect the communications wiring to the **Port S1** or **Port S2** screw terminals labeled **Net +**, **Net -**, and **Shield**.

NOTE Use the same polarity throughout the network segment.
- 4 If you are using **Port S1**, and the controller has a **Port S1 Configuration** rotary switch, set it to 1.

NOTE If **Port S1** is not being used for any network, set this rotary switch to 0.
- 5 If the TV-PSM controller is at either end of a network segment, set the port's **End of Net?** switch to **Yes**.

NOTE The controller's **End of Net** switch applies network termination and bias. See the *Open Controller Network Wiring Guide*.
- 6 Turn on the controller's power.
- 7 To verify communication with the network, get a Module Status report in the i-Vu® interface for a controller on the MS/TP network.

NOTE This step requires that you have discovered and uploaded the controller in the i-Vu® application.

To wire a third-party device

BACnet: You can wire a third-party BACnet device to the TV-PSM's **Gig-E** port, **Port S1**, or **Port S2**. See the *BACnet Integration Guide* for the TV-PSM.

Modbus: You can wire a third-party Modbus TCP/IP device (client or server) to the TV-PSM's **Gig-E** port or a Modbus master or slave device to **Port S1** or **Port S2**. See *Modbus Integration Guide* for the TV-PSM.

Wiring devices to the TV-PSM's Rnet port

You can wire the following devices to the TV-PSM's Rnet port in a daisy-chain configuration:

- ZS sensors
- Wireless Adapter that communicates with wireless sensors
- Equipment Touch
- TruVu™ ET Display

See the device's *Installation and Start-up* Guide for complete wiring instructions.

NOTES

- ZS sensors, a Wireless Adapter, and an Equipment Touch can share the same Rnet.
- The Rnet communicates at a rate of 115.2 kbps.

To communicate through the BACnet/IP Service Port network

You can connect to the Service Port to access your network through:

- Field Assistant
- The Carrier touchscreen device

1 Connect an Ethernet cable from a computer to the controller as shown below.

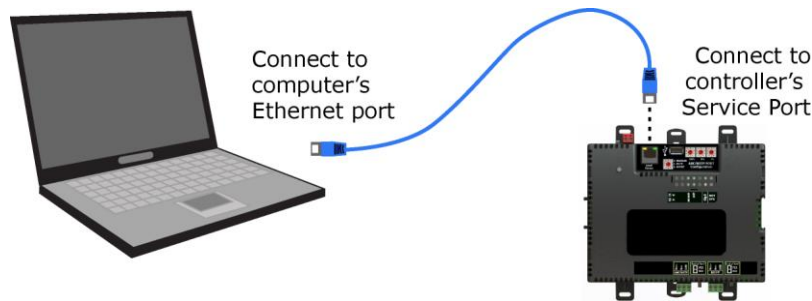

2 Turn off the computer's Wi-Fi if it is on.

3 Launch Field Assistant.

4 Select a **System Name**.

5 If you need to create a new **System Name**, click . Enter the **System Name**, then click **Create**. The **System Name** cannot:

- Begin with a number.
- Contain special characters other than a dash or an underscore.
- Exceed 40 characters.
- Contain capital letters or spaces. Use an underscore or dash between words.

6 Under **Communications**, select **BACnet/IP Service Port**.

7 Click  to start your system. This opens a new browser window.

8 On the **Devices** page > **Manage** tab, click **Find Devices** to discover your routers.

9 Once routers are found, select one router at a time in the left-hand navigation tree and click **Upload**. Use **Ctrl+click**, **Shift+click**, or both to select multiple items.

Adjusting the TV-PSM driver properties

After you find and upload the TV-PSM in the i-Vu® interface, you may want to customize the TV-PSM's settings for your applications. You can change settings on the **Driver Properties** page.

- 1 In the i-Vu® interface, right-click the TV-PSM in the navigation tree and select **Driver Properties**.
- 2 Adjust the driver as desired.

Driver

The **Driver** page provides the following information plus the items described in the table below:

- The date/time of last parameter change or the last time the database was archived
- If control programs, properties, and schedules were successfully stored in memory
- Undelivered Alarm Status

TouchScreen Control	
TouchScreen Schedule Edit Enable	<p>Check this field to allow a user to edit this controller's schedules from an Equipment Touch or System Touch Schedules screen.</p> <p>NOTE Schedules edited on an Equipment Touch or System Touch are not uploaded to the i-Vu® application. This could result in the controller operating on a schedule that differs from the one you see in the i-Vu® interface.</p>
Controller Clock	
Clock Fall Date and Time	Date and time the controller uses when its real-time clock is invalid.
Time Synch Sensitivity (seconds)	When the controller receives a time sync request, if the difference between the controller's time and the time sync's time is greater than this field's value, the controller's time is immediately changed. If the difference is less than this field's value, the controller's time is slowly adjusted until the time is correct.
Network Microblocks	
BACnet third party integration points capacity, integration points requested, and integration points active	<p>Shows how many third-party BACnet points the TV-PSM allows (capacity), how many points are in the control program (requested), and how many are currently active (not disabled in i-Vu®).</p> <p>For example, if the controller allows 400 points, the control program has 350 points, and you disabled 30 points in i-Vu®, you would see: Integration points capacity: 400 Integration points requested: 350 Integration points active: 320</p>
Modbus integration points capacity and integration points active	Shows how many Modbus points the TV-PSM allows (capacity) and how many are currently active.
Number of poll retries before Network Input Microblocks Indicate failure	The maximum number of retries after the initial attempt that a Network microblock will attempt to communicate with its target device. If unsuccessful, the point will transition to an idle state for 30 seconds before attempting to communicate again. Change this field only if directed by Technical Support.

Periodic rebinding interval	If a microblock uses a wildcard in its address, this timer determines how often the microblock will attempt to find the nearest instance of its target. For example, if an outside air temperature address uses a wildcard, a VAV application will look for the outside air temperature on the same network segment or on the nearest device containing that object.
BACnet COV Throttling	
Enable COV Throttling	<p>Under normal circumstances, COV Throttling should be enabled to prevent excessive network traffic if an object's COV Increment is set too low. See EXCEPTION below.</p> <p>When enabled, if an object generates excessive COV broadcasts (5 updates in 3 seconds), the driver automatically throttles the broadcasts to 1 per second. Also, if the object's value updates excessively for 30 seconds, an alarm is sent to the i-Vu® application listing <u>all</u> objects that are updating excessively. A Return-to-normal alarm is sent only after <u>all</u> objects have stopped updating excessively.</p> <p>EXCEPTION: In rare circumstances, such as process control, a subscribing object may require COV updates more frequently than once per second. For these situations, clear this checkbox, but make sure that your network can support the increased traffic. You will also need to disable the Excessive COV alarms under the driver's Common Alarms.</p>
Trend Sampling	
Collect a daily midnight sample for all points in this controller that are sampling on COV	For values that change infrequently, select to verify at midnight daily that the point is still able to communicate trend values.
Local Network Configuration	
Allow Local Network Configuration from other devices on the local network for 24 hours	You can unlock a device for 24 hours to make IP address changes.
Locator LED	
Blink	Click the Blink button to prompt the Net and Sys LEDs to blink on a device, allowing you to verify the physical location.
Debug	
Enable Debug Messages	Enable only if directed by Carrier Control Systems Support.

Device

The **Device** page provides the following information plus the items described in the table below:

- BACnet device object properties for the TV-PSM
- The character sets supported by this device for BACnet communication

Configuration	
BACnet System Status	The current state of the controller: Operational Download in Progress Download Required Backup in Progress Non-Operational
The following fields refer to all networks over which the TV-PSM communicates.	
APDU Timeout	How many milliseconds the device will wait before resending a message if no response is received.
APDU Segment Timeout	How many milliseconds the device will wait before resending a message segment if no response is received.
Number of APDU Retries	The number of times the device will resend a message.
Controller Clock	
Time Broadcaster will synchronize time every ____	If you have third-party BACnet devices on one of the router's networks, you can have the router send a BACnet time sync to those devices at the interval you define in this field.
Time Synchronization Recipients	To define third-party BACnet devices as Time Synchronization Recipients: <ol style="list-style-type: none"> 1 Click Add. 2 Select Device ID, Address, Local Broadcaster, or Global Broadcaster in the Recipient Type field. 3 If you selected Device ID or Address, enter the information. 4 Click Accept.

Notification Classes

A BACnet alarm's Notification Class defines:

- Alarm priority for Alarm, Fault, and Return to Normal states
- Options for BACnet alarm acknowledgment
- Where alarms should be sent (recipients)

Alarms in the i-Vu® application use Notification Class #1. The i-Vu® application is automatically a recipient of these alarms.

Priorities	NOTE BACnet defines the following Network message priorities for Alarms and Events.										
	<table border="1"> <thead> <tr> <th>Priority range</th> <th>Network message priority</th> </tr> </thead> <tbody> <tr> <td>00–63</td> <td>Life Safety</td> </tr> <tr> <td>64–127</td> <td>Critical Equipment</td> </tr> <tr> <td>128–191</td> <td>Urgent</td> </tr> <tr> <td>192–255</td> <td>Normal</td> </tr> </tbody> </table>	Priority range	Network message priority	00–63	Life Safety	64–127	Critical Equipment	128–191	Urgent	192–255	Normal
Priority range	Network message priority										
00–63	Life Safety										
64–127	Critical Equipment										
128–191	Urgent										
192–255	Normal										
Priority of Off-Normal	BACnet priority for Alarms.										
Priority of Fault	BACnet priority for Fault messages.										
Priority of Normal	BACnet priority for Return-to-normal messages.										
Ack Required for Off-Normal, Fault, and Normal	Specifies whether alarms associated with this Notification Class require a BACnet Acknowledgment for Off-Normal, Fault, or Normal alarms.										
	 TIP You can require operator acknowledgment for an Alarm or Return-to-normal message (stored in the i-Vu® database). In the i-Vu® interface on the Alarm > Enable/Disable tab, change the acknowledgment settings for an alarm source or an alarm category.										
Recipient List											
Recipients	<p>The first row in this list is from the i-Vu® application. Do not delete this row. Click Add if you want other BACnet devices to receive alarms associated with this Notification Class.</p> <p>NOTE Additional entries in this table may be lost after a download.</p>										
Recipient Description	Name that appears in the Recipients table.										
Recipient Type	<p>Use Address (static binding) for either of the following:</p> <ul style="list-style-type: none"> • Third-party BACnet device recipients that do not support dynamic binding • When you want alarms to be broadcast (you must uncheck Issue Confirmed Notifications). This use is rare. 										
Days and times	The days and times during which the recipient will receive alarms.										
Recipient Device Object Identifier	Type the Device Instance from SiteBuilder (or from the network administrator for third-party devices) in the # field.										
Process Identifier	Change for third-party devices that use a BACnet Process Identifier other than 1. The i-Vu® application processes alarms for any 32-bit Process Identifier.										
Issue Confirmed Notifications	Select to have a device continue sending an alarm message until it receives delivery confirmation from the recipient.										
Transitions to Send	Uncheck the types of alarms you do not want the recipient to get.										

Calendars

Calendars are provided in the driver for BACnet compatibility only. Instead, use the **Schedules** feature in the i-Vu® interface.

Common and Specific Alarms

On these pages, you can enable/disable, change BACnet alarm properties, or set delays for the following BACnet alarms:

Common alarms:

- All Programs Stopped
- Excessive COV
- Program Stopped
- Locked I/O
- Controller Halted
- Control Program
- Duplicate Address

Specific alarm:

- Dead Controller Timeout

NOTE To set up alarm actions for controller generated alarms, see *Setting up alarm actions* in the i-Vu® Help.

Controller Generated Alarm

Description	Short message shown on the Alarms page or in an alarm action when this type of alarm is generated.
Events	
Alarm Category and Alarm Template	See <i>Setting up an alarm source in the i-Vu® interface</i> in i-Vu® Help.
Enable	Clear these checkboxes to disable Alarm or Return to normal messages of this type from the TV-PSM.
Notification Class	In a typical i-Vu® system, the Notification Class is 1; however, if needed, you can associate a different notification class with the alarm. See <i>Notification Classes</i> (page 33) to set up alarm delivery options for a specific Notification Class.

Custom Translation Tables

Applies to the analog input of an attached expander.

You can set up a translation table that an analog input will use to translate the raw data from a non-linear sensor to the engineering units you want it to provide on the output wire of the Analog Input microblock. In the navigation tree, select **Custom Translation Table #1, #2, or #3**. The **Properties** page has instructions.

For the input to use the translation table, go to the control program's **Properties** page > **I/O Points** tab. Click the analog input in the **Name** column. On the **Details** tab, set **Sensor Type (Scaling Method)** to **Non-Linear, Custom Table #__**.

BACnet Router Properties



CAUTION Do not change the settings on this page as it will result in communication failure. Use *the controller setup pages* (page 42) to change settings and then resolve mismatches in the i-Vu® application.

BACnet Firewall

If this IP controller is accessible from the Internet, you can increase security by enabling its BACnet firewall. When enabled, this feature prevents the controller from responding to BACnet messages from unidentified sources and allows communication only with IP addresses that you define. These can be all private IP addresses and/or a list of IP addresses. Follow the instructions in the i-Vu® interface to set up the BACnet firewall.

Network Diagnostics - Statistics

This page shows the network statistics for each of the TV-PSM's ports that are in use. This same information is provided in a *Module Status report* (page 50).

Click the **Error Rate Trend** or **Packet Rate Trend** link at the bottom of each section to see the statistics displayed as trend graphs. You can also access these trends by clicking on the driver in the network tree, and then selecting **Trends > Enabled Points >** and the desired trend graph.

Click a port's **Reset** button to set all of the numbers to zero so the counting can start over.

Router Statistics	
Error Counters	Dropped Packets —Data packets that could not be delivered.
	Route Not Found —Packets that could not be delivered because the requested network does not exist.
	Route Unreachable —These are routed packets whose destination network is either busy or offline.
Network Activity	Shows the number of incoming and outgoing unicast and broadcast packets for each of the TV-PSM's networks.
Router Sourced Packets	Shows the number of packets initiated by the TV-PSM that are not in response to a request from another device. The numbers in this table will also appear in the appropriate columns in the Network Activity tab.
Trends	Error Rate Trend —Shows the total number of errors within the trend sampling interval.
	Packet Rate Trend —Shows the total number of packets transmitted and received within the trend sampling interval.

Gig-E Port Statistics	
BACnet/IP Statistics	BACnet/IP Rx Unicast Packets —BACnet/IP packets received from a single BACnet device.
	BACnet/IP Tx Unicast Packets —BACnet/IP packets transmitted to a single BACnet device.
	BACnet/IP Rx Broadcast Packets —BACnet/IP broadcast packets received by the TV-PSM.
	BACnet/IP Tx Broadcast Packets —BACnet/IP broadcast packets transmitted by the TV-PSM.
	Whitelist Rejections (if <i>BACnet Firewall</i> (page 35) is enabled)—Messages blocked by the BACnet Firewall because the IP address that sent the message was not in the whitelist.
Ethernet Statistics	Ethernet Rx packets —All packets (including non-BACnet packets such as a ping) received by the TV-PSM.
	Ethernet Tx packets —All packets (including non-BACnet packets such as a ping) transmitted by the TV-PSM.
	Receive Errors (total) —All errors related to received packets such as CRC errors, FIFO errors, frame errors, length errors, missed errors, and overrun errors.
	Transmit Errors (total) —All errors related to transmitted packets such as aborted errors, carrier errors, dropped errors, FIFO errors, heartbeat errors, and window errors.
	Dropped Packets —Packets dropped by the TV-PSM's Ethernet interface.
Trends	Error Rate Trend —Shows the total number of errors within the interval time.
	Packet Rate Trend —Shows the total number of packets transmitted and received within the trend sampling interval.

Network Diagnostics - Packet Capture

This page allows you to capture network communication on a port and then download the capture file for troubleshooting. Choose one of the following capture options:

- **Start/Stop** - Define the start and stop criteria, and then click **Start** and **Accept** to begin the capture. When the capture stops, the capture file is generated.

NOTE If a Start/Stop capture is running on any other port, the **Get capture file** button will be disabled until all Start/Stop captures have completed.

 - **Start capture:** - When you check **At (mm/dd/yyyy hh:mm AM/PM)**, enter the time and date, and click **Start**, the packet capture begins at the date and time you specified.

NOTE The hours field is validated from 0 to 12, and minute field is validated from 0 to 59.
 - **Continuous** - Click **Start** and **Accept** to begin the capture. Click **Save** to momentarily stop the capture and create the capture file. The capture will automatically resume. Click on the **Start/Stop** option to end the **Continuous** capture.
 - If the port is set up for MS/TP, select an option in the **Capture** section.

To download the capture file

Capture files are Wireshark files that are added to the Device Log Archive .tgz file. Do the following to view the files.

- 1 If you do not have Wireshark installed on your computer, download the latest version from the *Wireshark website* (<http://www.wireshark.org>).
- 2 Run the install program, accepting all defaults. Include WinPcap in the installation.
- 3 On the i-Vu® **Packet Capture** page, click **Get capture file** to download the .tgz file. The message appears "Retrieving the file, this may take a little while". Click **OK**.

NOTE If the size of the .tgz is large, there could be a considerable delay (for example, over 2 minutes) after you click **Get capture file** until your browser begins the download.

- 4 Open the .tgz file. The files are in the **captures** folder.

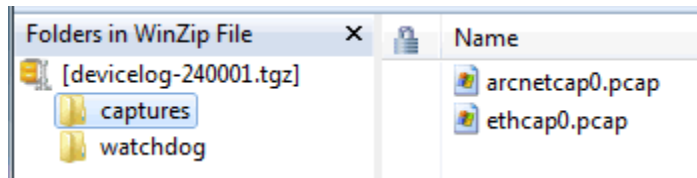

Capture file names are based on the ports.

NOTE Clicking **Get capture file** generates the port's .pcap file. If the port has a .pcap file from a previous capture, that file will be overwritten.

- 5 Extract the .pcap file from the .tgz file.
- 6 Open the .pcap file in Wireshark.

I/O Bus and Xnet Expanders

The **I/O Bus and Xnet Expanders** page provides the configuration and status information described in the table below.

I/O Bus Configuration		
Maximum I/O Bus Expanders	The controller can have no more than 9 TruVu™ MPC I/O expanders.	
Communication Timeout	If the TruVu™ MPC I/O expander does not receive communication from the controller for this amount of time, the expander will reset itself. The range is 15–300 seconds.	
I/O Bus Status		
The table shows information for all TruVu™ MPC I/O expanders that are communicating with the TV-PSM.		
Status	Possible statuses	Description
	Operational	TruVu™ MPC I/O expander is operating correctly.
	Error: Comm Fail	The controller and TruVu™ MPC I/O expander are not communicating.
	Error: Unsupported Type	The TruVu™ MPC I/O expander type is not compatible with the controller firmware version.
	Disabled	Status briefly shown before Error: Comm Fail appears.
	Download Required	The version of firmware in the TruVu™ MPC I/O expander is different than expander firmware in the TV-PSM.
	Downloading	The TruVu™ MPC I/O expander's firmware is being upgraded.
	Boot Running	Status briefly shown before Download Required appears.
	Error: Calibration	TruVu™ MPC I/O expander was not calibrated in the factory. Please return.
	Error: 15V Power Supply	TruVu™ MPC I/O expander has detected an issue with its 15V power supply.
	Error: 5V Power Supply	TruVu™ MPC I/O expander has detected an issue with its 5V power supply.
Input and Output Numbers	The number of inputs, HAOs, and outputs on the expander.	
FW Version	The version of firmware that is in the expander.	
Hardware Type	The number in this column should appear in the list of Expander Types Supported in the I/O Bus Firmware Inventory section.	
Network Termination	Shows if the expander's I/O Bus End of Net? switch is set to Yes (On) or No (Off).	
Model Type	The expander model.	

I/O Bus Firmware Inventory		
Version	The version of TruVu™ MPC I/O expander firmware that is in the TV-PSM.	
Expander Types Supported	The TruVu™ MPC I/O expander types supported by the TV-PSM.	
Xnet Configuration		
Data Rate	Set at 500 kbps.	
Maximum Xnet expanders	The controller can have no more than 6 MPC Open XPIO bus expanders.	
Communication Timeout (seconds)	If the MPC Open XPIO expander does not receive communication from the controller for this amount of time, the expander will reset itself. The range is 15–300 seconds.	
Xnet Expander Status		
The table shows information for all MPC Open XPIO expanders that are communicating with the TV-PSM.		
Status	Possible statuses	Description
	Operational	MPC Open XPIO expander is operating correctly.
	Error: Comm Fail	The controller and MPC Open XPIO expander are not communicating.
	Error: Unsupported Type	The MPC Open XPIO expander type is not compatible with the controller firmware version.
	Disabled	Status briefly shown before Error: Comm Fail appears.
	Download Required	The version of firmware in the MPC Open XPIO expander is different than expander firmware in the TV-PSM.
	Downloading	The MPC Open XPIO expander's firmware is being upgraded.
	Boot Running	Status briefly shown before Download Required appears.
Input and Output Numbers	The number of inputs, HAOs, and outputs on the expander.	
FW Version	The version of firmware that is in the expander.	
Hardware Type	The number in this column should appear in the list of Expander Types Supported in the I/O Bus Firmware Inventory section.	
Model Type	The expander model.	
Xnet Expander Firmware Inventory		
Version	The version of MPC Open XPIO expander firmware that is in the TV-PSM.	
Expander Types Supported	The MPC Open XPIO expander types supported by the TV-PSM.	

Communication Status

The **Communication Status** page shows the status of the protocols currently running on the TV-PSM's ports.

Standalone Controller Detection

You can use the fields on this page with a binary input in your control program to detect when the controller does not receive a write request from the selected network within the specified amount of time. The input remains OFF as long as write requests are received, but switches to ON if the controller does not receive a request within the specified time. The binary input must have the Expander number and Input number set to **99** and the I/O Type set to **Special**.

Modbus Serial, Modbus TCP/IP, and Modbus Error Definitions pages

If the controller will be used with Modbus devices, see the *Modbus Integration Guide* for information on using these pages.

To set up Network Statistic trends

PREREQUISITE To view Network Statistic trends, you must have a i-Vu® v6.5 or later system with the latest cumulative patch.

To view the *Network Statistics* (page 35) as trend graphs, select the controller in i-Vu®'s navigation tree and go to one of the following:

- On the **Driver Properties > Network Diagnostics > Statistics** page, click a **Trend** link at the bottom of each section.
- Click the **Trends** drop-down button, select **Enabled Points** and then the graph you want.

You can define:

- How the graph looks on the trend's **Configure** tab.
- How you want trend samples to be collected on the **Enable/Disable** tab. See table below.

Field	Notes
Sample every _:._: (hh:mm:ss)	(Recommended method) To record the value at a regular time interval, enter hh:mm:ss in this field.
Sample on COV (change of value)	To record the value only when the value changes by at least the amount of the COV Increment , set the Sample every field to 0:00:00 and enter a value in the COV Increment field.
Max samples	Network Statistic trends have a non-configurable maximum trend log buffer size of 1440. NOTE Trending consumes memory in the controller. Click Reset to delete all samples currently stored in the controller.

Field	Notes
Stop When Full	Check this field to stop trend sampling when the maximum number of samples is reached.
Enable trend log at specific times only	Collects trend data for the specific period of time you define in the time and date fields.
Enable Trend Historian	Archives trend data to the system database.
Store Trends Now	Writes all trend data in the controller to the system database without having to enable trend historian.
Write to historian every __ trend samples	Writes all trend data in the controller to the system database each time the controller collects the number of samples that you enter in this field. This number must be greater than zero and less than the number entered in the Max samples field. The number of trends specified must be accumulated at least once before the historical trends can be viewed. NOTE Any trends not stored in the historian will be lost if the controller loses power.
Trend samples accumulated since last notification	Shows the number of samples stored in the controller since data was last written to the database.
Last Record Written to Historian	Shows the number of trend samples that were last written to the database.
Keep historical trends for __ days	This is based on the date that the sample was read. Select the first option to use the system default that is defined on the System Options > System Settings > General tab. Select the second option to set a value for this trend only.

To set up the controller through the Service Port

To set up the controller through the Service Port

Using a computer and an Ethernet cable, you can communicate with the TV-PSM through a web browser to:

- View the controller's Module Status report
- View/change controller and network settings. Changes take effect immediately.
- Troubleshoot
- Use BACnet/IP Service Port to access the i-Vu® application or a touchscreen device. See To communicate through the BACnet/IP Service Port network.

- 1 Connect an Ethernet cable from a computer to the controller as shown below.

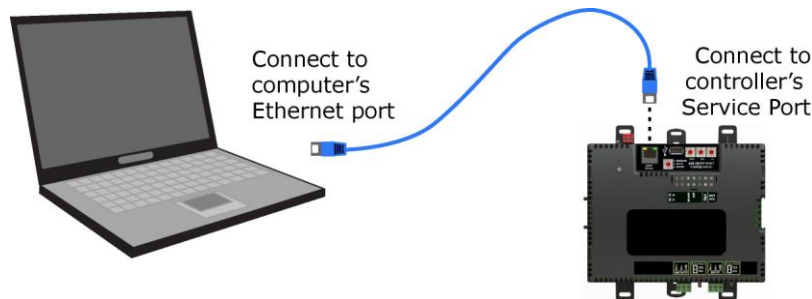

- 2 Turn off the computer's Wi-Fi if it is on.
- 3 If your computer uses a static IP address, use the following settings:
 - Address: 169.254.1.x, where x is 2 to 7
 - Subnet Mask: 255.255.255.248
 - Default Gateway: 169.254.1.1
- 4 If it uses a DHCP address, leave the address as it is.
- 5 Open a web browser on the computer.
- 6 Navigate to <http://local.access> or <http://169.254.1.1> to see the Service Port controller setup pages.

NOTE The first time you access the controller in the i-Vu® interface after you have changed settings through the Service Port, be sure to upload the changes to the system database. This will preserve those settings when you download memory or parameters to the controller.

ModStat tab

This tab provides the controller's Module Status report that gives information about the controller and network communication status. See *Appendix - Module Status field descriptions* (page 54).

Device tab

BACnet Object	
Device Instance	<p>Autogenerated—(Default) The Device ID is automatically set to a number equal to the (IP network number) x 100 + rotary switch address.</p> <p>Assigned—Lets you enter a specific number that is unique on the BACnet network.</p>
Device Name	<p>Autogenerated—(Default) The Device Name is automatically set as the word device + the Device Instance. For example, device2423911.</p> <p>Assigned—Lets you enter a specific name that is unique on the BACnet network.</p>
Device Location	You can enter an intuitive location for the device in the i-Vu® interface.
Device Description	You can enter an intuitive description for the device in the i-Vu® interface.
Configuration	
APDU Timeout	How many milliseconds the device will wait before resending a message if no response is received.
APDU Segment Timeout	How many milliseconds the device will wait before resending a message segment if no response is received.
APDU Retries	The number of times the device will resend a message.
Controller Information	
Clear Counts/Logs	Clears Reset counters and the three message history fields from the Module Status.
Data Backup and Restore	
Backup	Displays time of the last backup. Click button to backup the controller's control programs, properties, and schedules.
Restore	Displays time of the last restore. Click button to restore the most recent backup of the controller's control programs, properties, and schedules.
Network Factory Defaults	
Reset	Resets the controller to network factory default settings.

To set up the controller through the Service Port

Ports tab

IP Port	
IP Addressing	Select the type of addressing the controller is to use. See <i>Addressing the TV-PSM</i> (page 16).
Ethernet Port	
Address	A factory assigned Ethernet MAC Address for the Gig-E port.
Port S1	
End of Network	Indicates status of the controller's End of Net? switch.
Active Protocol	Indicates status of the controller's Port S1 Configuration rotary switch. 0=Disabled 1=MS/TP 2=ARCNET 3=Modbus
Port S2	
End of Network	Indicates status of the controller's End of Net? switch.
Protocol	Change active protocol, if needed.
Active Protocol	Indicates if Port S2 is enabled for Modbus.

BACnet tab

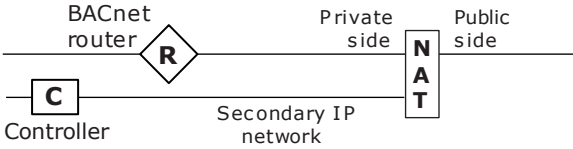
IP Port	
BACnet Network Number	<p>Disable Routing—Select if the IP port is not used.</p> <p>Autogenerated—The BACnet/IP network number is automatically set to 1600.</p> <p>Assigned—Lets you enter a specific number.</p>
BACnet UDP Port	The port that the i-Vu® application will use for BACnet communication.
Enable NAT Routing	<p>For future use.</p> <p>Check if the TV-PSM is behind a NAT router (firewall).</p>
BACnet Secondary IP Net Number	<p>If the TV-PSM has two BACnet/IP networks communicating on the Gig-E port, enter the second IP network number in this field.</p> <p>If the TV-PSM is behind a NAT router and there is a second network with BACnet/IP devices behind the NAT router, enter the second network number in this field to logically connect the TV-PSM to the devices on the second network.</p>  <p>The diagram illustrates a network topology. On the left, a box labeled 'C' (Controller) is connected to a diamond-shaped box labeled 'R' (BACnet router). This 'R' box is connected to a horizontal line representing the 'Private side' of a NAT router. A vertical box labeled 'NAT' is positioned at the junction of the 'Private side' and 'Public side' lines. Below the 'Private side' line, there is another horizontal line labeled 'Secondary IP network'.</p>
BACnet Secondary UDP Port	If the TV-PSM has two BACnet/IP networks communicating on the Gig-E port, enter the port number that the i-Vu® application will use for BACnet communication. This port must be different than the BACnet UDP Port .
Ethernet Port	
BACnet Network Number	Specify a number for the BACnet/Ethernet network or set to 0 if the port is not used.
Port S1	
Active Protocol	Indicates status of the controller's Port S1 rotary switch. 0=Disabled 1=MS/TP 2=ARCNET 3=Modbus
Address	The address that is set on the three rotary switches. See <i>To set the Port S1 address and baud rate</i> (page 20).
ARCNET Baud Rate	156000
BACnet Network Number	<p>Select:</p> <p>Disable Routing if Port S1 is not used.</p> <p>Autogenerated to have the network number for Port S1 automatically set to a number equal to ((IP network number + rotary switch address) x 10).</p> <p>Assigned to enter a specific number.</p>
Port S2	
Active Protocol	<p>Shows one of the following:</p> <ul style="list-style-type: none"> • Modbus if enabled on the Modbus tab • BACnet/MSTP if you enter a BACnet Network Number below for an MS/TP network • Disabled if neither of the above have been done
Home Network	This is typically the network that is communicating with the building automation system's application. This sets the BACnet Address of the Device object.

To set up the controller through the Service Port

Modbus tab

If the controller will be used with Modbus devices, see the *Modbus Integration Guide* for information on using this tab.

Security tab

BACnet Firewall

If your BACnet Firewall configuration in the i-Vu® interface did not include the i-Vu® server IP address, thus blocking communication with the i-Vu® server, you can disable the controller's BACnet Firewall on the controller setup **Security** tab.

NOTE You can enable the BACnet Firewall only in the i-Vu® interface.

To communicate locally through the Rnet port

You can connect a computer running Field Assistant to the TV-PSM's **Rnet** port to download or troubleshoot.

PREREQUISITES

- A computer with a USB port
- A USB Link (Part #USB-L)
- For the Field Assistant application to communicate with the controller, the controller must have been downloaded with at least its driver.
- A 3-pin screw terminal connector and 3-wire cable



CAUTIONS

- Maintain polarity when controllers share power.
- Failure to maintain polarity while using the USB Link on a computer that is grounded via its AC adapter may damage the USB Link and the controller.
- If multiple controllers share power but polarity was not maintained when they were wired, the difference between the controller's ground and the computer's AC power ground could damage the USB Link and the controller. If you are not sure of the wiring polarity, use a USB isolator between the computer and the USB Link. Purchase a USB isolator online from a third-party manufacturer. Plug the isolator into your computer's USB port, and then plug the USB Link cable into the isolator.

- 1 The USB Link driver is installed with a v6.5 or later system. Please refer to the Silicon Labs website and search "CP210x USB to UART Bridge VCP Drivers" for the most current device drivers. Install the driver before you connect the USB Link to your computer.
- 2 Connect one end of a piece of 3-wire cable to the 3-pin connector.

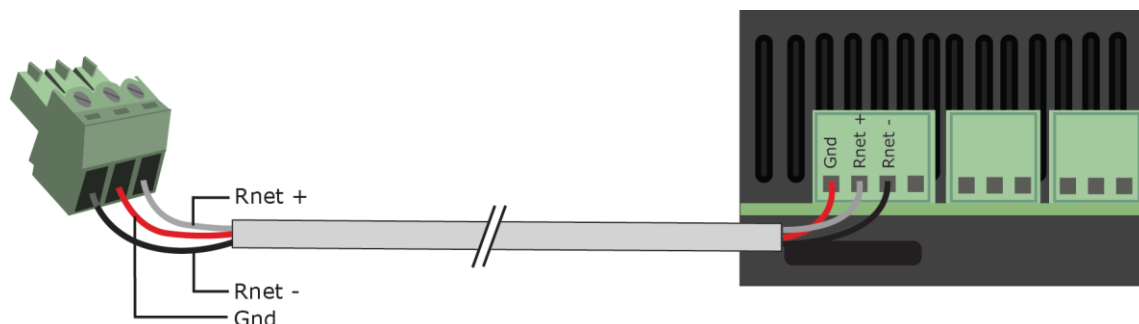

- 3 Connect the other end of the 3-wire cable to the TV-PSM's **Rnet** port as shown in the drawing above in step 1.
- 4 Connect the 3-pin connector to the portion of the USB link kit shown in the drawing below, then connect the USB connector to the computer.

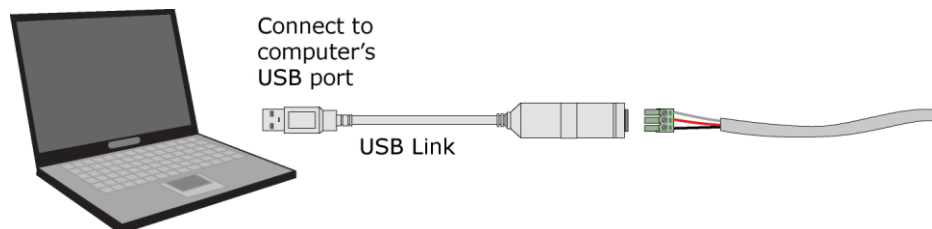

Troubleshooting

If you have problems mounting, wiring, or addressing the TV-PSM, contact Carrier Control Systems Support.

LEDs

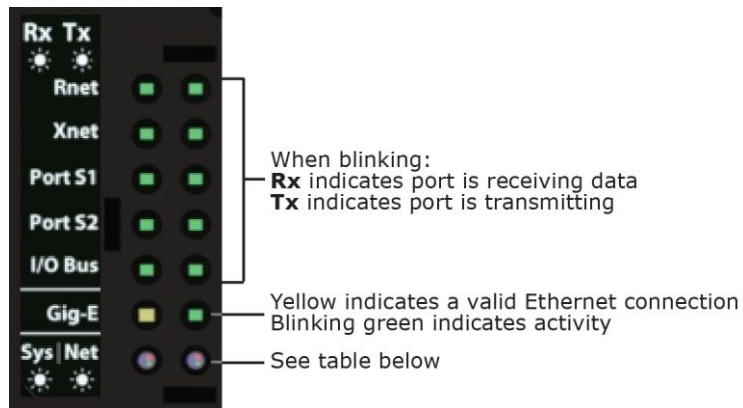

Net (Network Status) Tricolor LED

Color	Pattern	Condition	Message In Module Status	Possible Solutions
Red	On	Ethernet connection problem	No Ethernet Link	<ul style="list-style-type: none"> Connect Ethernet Cable Check other network components
Red	1 blink	One of the following BACnet/IP (Ethernet) DLL reporting issue: <ul style="list-style-type: none"> Unable to create tasks Unable to open socket for BACnet port 	BACnet/IP error	Cycle power
Red	2 blink	Current default IP address does not match the current rotary switch setting	Default IP address mismatch	<ul style="list-style-type: none"> Use the controller setup Ports tab to set the IP address Cycle power to accept new IP address Change rotary switches to match current default IP address

Net (Network Status) Tricolor LED

Color	Pattern	Condition	Message in Module Status	Possible Solutions
Blue	On	One of the following issues: <ul style="list-style-type: none"> Port communication firmware did not load properly Port communication firmware is not running Invalid protocol selected 	ARCNET/MSTP firmware error	<ul style="list-style-type: none"> Change rotary switch to select valid protocol Cycle power
Blue	1 blink	Invalid address selected for protocol	Invalid address selection for ARCNET/MSTP	Change rotary switch to valid address
Blue	2 blink	Controller has same MAC address as another connected device	Duplicate address on MSTP	Change rotary switch to unique address
Blue	3 blink	Controller is the only device on the network	No other devices detected on ARCNET/MSTP	<ul style="list-style-type: none"> Check that network cable is connected properly Check that baud rate is correct
Blue	4 blink	Excessive errors detected over 3 second period	Excessive communication errors on ARCNET/MSTP	<ul style="list-style-type: none"> Check that network cable is connected properly Check that baud rate is correct
Blue	5 blink	ARCNET traffic overload possibly due to circular route or excessive COVs (change of values)	Event System Error - FPGA RX FIFO full	<ul style="list-style-type: none"> Check the network configuration for a circular route Increase the time between COVs to reduce excessive COV traffic
Green	On	All enabled networks are functioning properly	No errors	No action required

Sys (System Status) Tricolor LED

Color	Pattern	Condition	Message in Module Status	Possible Solution
Red	2 blink	Restarting after an abnormal exit	Auto restart delay due to system error on startup	After 5 minute delay has expired, if condition occurs again then cycle power
Red	4 blink	Firmware image is corrupt	Firmware error	Download driver again
Red	Fast blink	Firmware error has caused the firmware to exit and restart	Fatal error detected	No action required
Green	1 blink	No errors	Operational	No action required
Green	2 blink	Download of driver is in progress	Download in progress	No action required

Sys (System Status) Tricolor LED

Color	Pattern	Condition	Message in Module Status	Possible Solution
Green	3 blink	BACnet Device ID is not set	Download required	Download the controller
Green	Fast blink	Installation of recently downloaded driver is occurring	N/A	No action required
Blue	On	Controller is starting up	N/A	No action required
Blue	Slow blink	Linux (operating system) is starting up	N/A	No action required
Blue	Fast blink	Linux is running but it could not start the firmware application	N/A	Download driver

To get a Module Status report

A Module Status report provides information about the controller and verifies proper network communication with the controller. You can get this report:

- In the i-Vu® application—Right-click the controller on the navigation tree, then select **Module Status**.
- In the Field Assistant application—Right-click the controller in the navigation tree and select **Module Status**.
- On the controller setup **ModStat** tab—See *To set up the controller through the Service Port* (page 42).

See Module Status field descriptions in the Appendix.

To get a Device Log

If Carrier Control Systems Support instructs you to get the controller's Device Log containing diagnostic information for troubleshooting:

- 1 Select the TV-PSM in the i-Vu® navigation tree.
- 2 On the **Properties** page, click **Device Log**.

NOTE You can click **Device Log Archive** to download a file containing multiple Device Logs to your computer. This also contains any network packet captures that have been run from the *Network Diagnostics - Packet Captures* (page 36) driver page.

To get the TV-PSM's serial number

If you need the controller's serial number when troubleshooting, the number is on:

- A Module Status report (Modstat).
- A laser-etched number and QR code on the circuit board inside the controller.
- Some controllers have a sticker on the front with the serial number, MAC address, and a QR code.



See *To get a Module Status report* (page 50).

To replace the TV-PSM's fuses

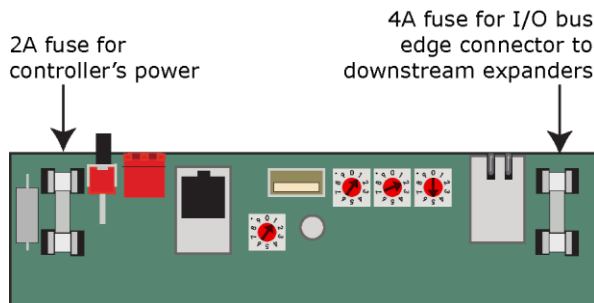
The TV-PSM has 2 fuses:



Symptoms of a blown fuse:

- TV-PSM's power fuse—The controller's  LED is not lit.
- I/O bus edge connector fuse—The  LED is not lit on downstream expanders connected to the edge connector.

NOTE If the TV-PSM's power fuse blows but not the I/O bus edge connector fuse, the TV-PSM will be off but not the downstream expanders.

If you suspect a fuse is blown, remove the fuse as described below, and use a multimeter to check it. If the fuse is blown, try to determine why it blew before you replace it. Check the power wiring polarity of the TV-PSM and any other devices that share the power supply. Use the same polarity for all of them.

The fuses are fast-acting, 5mm x 20mm glass fuses that you can purchase from one of the following vendors:

Manufacturer	Mfr. Part # for 2A fuse	Mfr. Part # for 4A fuse
Littelfuse	0217002.HXP	0217004.HXP
Bussmann	S500-2-R	S500-4-R
Belfuse	5SF 2-R	5SF 4-R
Optifuse	FSD-2A	FSD-4A

To replace the fuse:

- 1 Turn off the TV-PSM's power switch.
- 2 Remove the red power connector.
- 3 On both ends of the TV-PSM, insert a small flathead screwdriver as shown below, and then gently pry up the cover until it is released from the base.

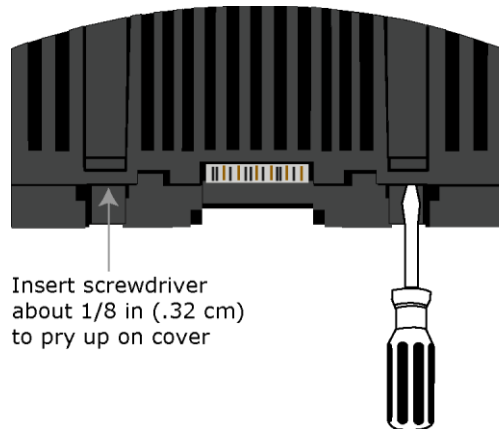

- 4 Remove the cover from the base.
- 5 Use a fuse puller to remove the blown fuse.
- 6 Use the fuse puller to snap the new fuse into the fuse holder.
- 7 Replace the TV-PSM's cover.
- 8 Replace the power connector.
- 9 Turn on the TV-PSM's power switch.
- 10 Verify the  LEDs on the TV-PSM and any downstream expanders are lit.

To take the TV-PSM out of service

If needed for troubleshooting or start-up, you can prevent the i-Vu® application from communicating with the TV-PSM by shutting down communication from the TV-PSM to the i-Vu® application. When **Out of Service**, i-Vu® no longer communicates properties, colors, trends, etc.

- 1 On the i-Vu® navigation tree, select the TV-PSM.
- 2 On the **Properties** page, check **Out of Service**.
- 3 Click **Accept**.

Compliance

FCC Compliance

This device complies with Part 15 of the FCC Rules. Operation is subject to the following two conditions:

- 1 This device may not cause harmful interference.
- 2 This device must accept any interference received, including interference that may cause undesired operation.

NOTE This equipment has been tested and found to comply with the limits for a Class A digital device, pursuant to Part 15 of the FCC Rules. These limits are designed to provide reasonable protection against harmful interference when the equipment is operated in a commercial environment. This equipment generates, uses, and can radiate radio frequency energy, and if it is not installed and used in accordance with this document, it may cause harmful interference to radio communications. Operation of this equipment in a residential area is likely to cause harmful interference, in which case the user will be required to correct the interference at his own expense.



CAUTION Any modifications made to this device that are not approved by Carrier will void the authority granted to the user by the FCC to operate this equipment.

CE and UKCA Compliance



WARNING This is a Class B product. In a light industrial environment, this product may cause radio interference in which case the user may be required to take adequate measures.

Industry Canada Compliance

This Class A digital apparatus complies with Canadian ICES-003.
Cet appareil numérique de la classe A est conforme à la norme NMB-003 du Canada.

BACnet Compliance

Compliance of listed products to requirements of ASHRAE Standard 135 is the responsibility of BACnet International. BTL® is a registered trademark of BACnet International.

Appendix A: Module Status field descriptions

Field	Description
Date/Time	Date and time the Modstat was run
CM	The controller's rotary switch address (MAC address)
Model Name	Identifies the Product Type
Device Instance	A unique ID assigned to the controller
Driver built	When the driver was built
Downloaded by	When and where the last download was performed
Application Software Version	The name of the first control program that is downloaded
Data Partition Version	Data Partition identifies the clipping used when the product was manufactured. NOTE This field will say None except for a Carrier product from the factory. If a Carrier product is subsequently downloaded in the field, then this field will say None .
# PRGs initialized # PRGs running	If applicable, the number of control programs that were downloaded vs. the number that are running. If these numbers are not the same, the controller has a problem such as lack of memory.
Driver version	The name, version, and date of the driver, as well as all the bundles and versions.
Reset Counters:	The number of times each of the following events have occurred since the last time the controller was commanded to clear the reset counters. See NOTE below this table.
Power failures	Interruption of incoming power
Commanded boots	Includes commands issued from the i-Vu® interface such as the zap manual command, plus commands issued during a memory download.
System errors	Error in the controller's firmware or hardware
S/W Watchdog timeouts	Watchdog is firmware that monitors the application firmware for normal operation. If the watchdog firmware detects a problem, it restarts the application firmware.
H/W Watchdog timeouts	H/W Watchdog will restart the controller if it detects a severe problem with the controller's operating system
System status	Gives the current status of the controller's operation. See <i>LEDs</i> (page 48) for all possible conditions.
Network status	Gives the current status of the controller's networks. See <i>LEDs</i> (page 48) for all possible conditions.
System error message history	High-severity errors since the last memory download. Shows the most recent 10 messages. See NOTE below this table.

Field	Description
Warning message history	Low-severity errors and warning messages since the last memory download. Shows the most recent 10 messages. See NOTE below this table.
Information message history	Information-only messages since the last memory download. Shows the most recent 10 messages. See NOTE below this table.
ARC156 reconfigurations during the last hour	An ARCNET network normally reconfigures itself when a controller is added to or taken off the network. The Total field indicates the number of reconfigurations in the last hour. Initiated by this node indicates the number of reconfigurations initiated by this controller. Typical sources of the problem could be this controller, the controller with the next lower rotary switch address, any controller located on the network between these two controllers, or the wiring between these controllers. An excessive number in these fields indicates a problem with the network.
Core and Base board hardware	Gives the following information about the controller's boards: <ul style="list-style-type: none"> Type and board numbers that are used internally by Carrier. The manufacture date and serial number.
Number of BACnet Objects	Indicates the number of BACnet objects that were created in the device and the number of those objects that are network visible
Database Partition	Non-Volatile partition (16 MB maximum) contains data that needs to be preserved through a power cycle and archived to flash such as parameters and trend data. Volatile partition (6 MB maximum) contains data that does not need to be preserved through a power cycle such as status values that are calculated during runtime.
IP Networks - BBMDs	Shows the following information for each active IP network: BBMD Active shows whether the BACnet Broadcast Management Device is currently active (1) or inactive (0). BBMD Entries —the number of entries in the BBMD table (500 maximum). FDT Entries —the number of entries in the Foreign Device Table (500 maximum).
Third party integration points	Shows number of points used.
Modbus integration points	Shows number of points used.
Network Information	The various network addresses for the controller. The Current and Assigned addresses will be the same unless the Enable IP configuration changeover on the BACnet Router Properties page is being implemented.
Statistics and Network Activity	Shows network communication statistics to assist with troubleshooting. See <i>Network Diagnostics - Statistics</i> (page 35) for more information.
Route Information Port Number	BACnet networks that a router is currently routing traffic to. The list changes as BACnet routers are added or removed from the system.

NOTE If you want to clear the Reset counters and the three message history fields, click the **Clear Counts/Logs** button on the controller's **Properties** page in the i-Vu® application or in the controller setup **Device** tab.

Appendix B: TV-PSM wire lists

TV-PSM wire list

**I-Vu® chiller plant system network
controller**

Project Name:					Controller:																					
Location:					Network Number:																					
					MAC Address:																					
<table border="1" style="margin: auto; border-collapse: collapse;"> <tr> <td style="padding: 2px;">Aux Power Out</td> <td style="padding: 2px; text-align: center;">1</td> <td style="padding: 2px;"></td> <td style="padding: 2px; text-align: center;">24 Vdc</td> <td style="padding: 2px;"></td> <td style="padding: 2px;"></td> <td style="padding: 2px;"></td> <td style="padding: 2px;"></td> <td style="padding: 2px;"></td> </tr> <tr> <td style="padding: 2px;"></td> <td style="padding: 2px; text-align: center;">2</td> <td style="padding: 2px;"></td> <td style="padding: 2px; text-align: center;">24 Vdc</td> <td style="padding: 2px;"></td> <td style="padding: 2px;"></td> <td style="padding: 2px;"></td> <td style="padding: 2px;"></td> <td style="padding: 2px;"></td> </tr> </table>									Aux Power Out	1		24 Vdc							2		24 Vdc					
Aux Power Out	1		24 Vdc																							
	2		24 Vdc																							
<p style="margin: 0;">Thermistor Dry-contact RTD</p> <div style="display: flex; justify-content: space-around; align-items: center;"> <div style="text-align: center;"> <p style="margin: 0;">0-20mA</p> </div> <div style="text-align: center;"> <p style="margin: 0;">0-10V</p> </div> </div> <p style="margin: 0;">Universal Input Mode Select (Jumper Position of Pins)</p>																										
Point/ Cable#	Universal Inputs (+)	(G)	Input Type	Jumper Position of Pins	I/O	Sensor code	Equipment Name	Point Name																		
1	1	2	0-20 mA	Left	UI-1																					
	1	2	Thermistor Dry contact RTD	Middle																						
	1	2	0-10 V	Right																						
2	3	4	0-20 mA	Left	UI-2																					
	3	4	Thermistor Dry contact RTD	Middle																						
	3	4	0-10 V	Right																						
3	5	6	0-20 mA	Left	UI-3																					
	5	6	Thermistor Dry contact RTD	Middle																						
	5	6	0-10 V	Right																						
4	7	8	0-20 mA	Left	UI-4																					
	7	8	Thermistor Dry contact RTD	Middle																						
	7	8	0-10 V	Right																						
5	9	11	0-20 mA	Left	UI-5																					
	9	11	Thermistor Dry contact RTD	Middle																						
	9	11	0-10 V	Right																						
6	10	11	0-20 mA	Left	UI-6																					
	10	11	Thermistor Dry contact RTD	Middle																						
	10	11	0-10 V	Right																						
7	12	14	0-20 mA	Left	UI-7																					

	12	14	Thermistor Dry contact RTD	Middle				
	12	14	0-10 V	Right				
8	13	14	0-20 mA	Left	UI-8			
	13	14	Thermistor Dry contact RTD	Middle				
	13	14	0-10 V	Right				
9	15	17	0-20 mA	Left	UI-9			
	15	17	Thermistor Dry contact RTD	Middle				
	15	17	0-10 V	Right				
10	16	17	0-20 mA	Left	UI-10			
	16	17	Thermistor Dry contact RTD	Middle				
	16	17	0-10 V	Right				
11	18	20	0-20 mA	Left	UI-11			
	18	20	Thermistor Dry contact RTD	Middle				
	18	20	0-10 V	Right				
12	19	20	0-20 mA	Left	UI-12			
	19	20	Thermistor Dry contact RTD	Middle				
	19	20	0-10 V	Right				

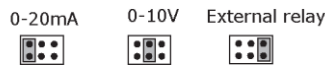

Universal Output Mode Select (Jumper Position of Pins)

Point/ Cable#	Universal Outs (+)	(G)	Output Type	Jumper Position of Pins	I/O	Sensor code	Equipment Name	Point Name
1	1	2	0-20 mA	Left	UO-1			
			0-10 Vdc	Middle				
			Relay	Right				
2	3	4	0-20 mA	Left	UO-2			
			0-10 Vdc	Middle				
			Relay	Right				
3	5	6	0-20 mA	Left	UO-3			
			0-10 Vdc	Middle				
			Relay	Right				
4	7	8	0-20 mA	Left	UO-4			
			0-10 Vdc	Middle				
			Relay	Right				
5	1	2	0-20 mA	Left	UO-5			
			0-10 Vdc	Middle				
			Relay	Right				
6	3	4	0-20 mA	Left	UO-6			
			0-10 Vdc	Middle				
			Relay	Right				
7	5	6	0-20 mA	Left	UO-7			
			0-10 Vdc	Middle				

			Relay	Right			
8	7	8	0-20 mA	Left	UO-8		
			0-10 Vdc	Middle			
			Relay	Right			

MPC Open XPIO48 wire list

System network MPC Open XPIO48 expander

Project Name:	Controller:
Location:	Network Number:
	MAC Address:

Aux Power Out	1		24 Vdc				
	2		24 Vdc				

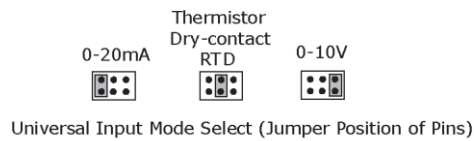

Point/ Cable#	Universal Inputs (+)	(G)	Input Type	Jumper Position of Pins	I/O	Sensor code	Equipment Name	Point Name
1	1	2	0-20 mA	Left	UI-1			
	1	2	Thermistor Dry contact RTD	Middle				
	1	2	0-10 V	Right				
2	3	4	0-20 mA	Left	UI-2			
	3	4	Thermistor Dry contact RTD	Middle				
	3	4	0-10 V	Right				
3	5	6	0-20 mA	Left	UI-3			
	5	6	Thermistor Dry contact RTD	Middle				
	5	6	0-10 V	Right				
+4	7	8	0-20 mA	Left	UI-4			
	7	8	Thermistor Dry contact RTD	Middle				
	7	8	0-10 V	Right				
5	1	2	0-20 mA	Left	UI-5			
	1	2	Thermistor Dry contact RTD	Middle				

	1	2	0-10 V	Right				
6	3	4	0-20 mA	Left	UI-6			
	3	4	Thermistor Dry contact RTD	Middle				
	3	4	0-10 V	Right				
7	5	6	0-20 mA	Left	UI-7			
	5	6	Thermistor Dry contact RTD	Middle				
	5	6	0-10 V	Right				
8	7	8	0-20 mA	Left	UI-8			
	7	8	Thermistor Dry contact RTD	Middle				
	7	8	0-10 V	Right				

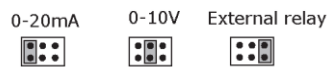

Universal Output Mode Select (Jumper Position of Pins)

Point/ Cable#	Universal Outs (+)	(G)	Output Type	Jumper Position of Pins	I/O	Sensor code	Equipment Name	Point Name
1	1	2	0-20 mA	Left	UO-1			
			0-10 Vdc	Middle				
			Relay	Right				
2	3	4	0-20 mA	Left	UO-2			
			0-10 Vdc	Middle				
			Relay	Right				
3	5	6	0-20 mA	Left	UO-3			
			0-10 Vdc	Middle				
			Relay	Right				
4	7	8	0-20 mA	Left	UO-4			
			0-10 Vdc	Middle				
			Relay	Right				

MPC Open XPIO816 wire list

System network
MPC Open XPIO816 expander

Project Name:	Controller:
Location:	Network Number:
	MAC Address:

Aux Power Out	1		24 Vdc				
	2		24 Vdc				

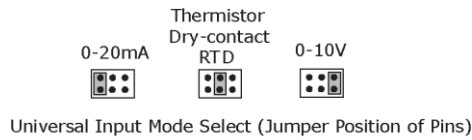

Point/ Cable#	Universal Inputs (+)	(G)	Input Type	Jumper Position of Pins	I/O	Sensor code	Equipment Name	Point Name
1	1	2	0-20 mA	Left	UI-1			
	1	2	Thermistor Dry contact RTD	Middle				
	1	2	0-10 V	Right				
2	3	4	0-20 mA	Left	UI-2			
	3	4	Thermistor Dry contact RTD	Middle				
	3	4	0-10 V	Right				
3	5	6	0-20 mA	Left	UI-3			
	5	6	Thermistor Dry contact RTD	Middle				
	5	6	0-10 V	Right				
4	7	8	0-20 mA	Left	UI-4			
	7	8	Thermistor Dry contact RTD	Middle				
	7	8	0-10 V	Right				
5	1	2	0-20 mA	Left	UI-5			
	1	2	Thermistor Dry contact RTD	Middle				
	1	2	0-10 V	Right				
6	3	4	0-20 mA	Left	UI-6			
	3	4	Thermistor Dry contact RTD	Middle				
	3	4	0-10 V	Right				
7	5	6	0-20 mA	Left	UI-7			
	5	6	Thermistor Dry contact RTD	Middle				
	5	6	0-10 V	Right				

8	7	8	0-20 mA	Left	UI-8			
	7	8	Thermistor Dry contact RTD	Middle				
	7	8	0-10 V	Right				
9	1	2	0-20 mA	Left	UI-9			
	1	2	Thermistor Dry contact RTD	Middle				
	1	2	0-10 V	Right				
10	3	4	0-20 mA	Left	UI-10			
	3	4	Thermistor Dry contact RTD	Middle				
	3	4	0-10 V	Right				
11	5	6	0-20 mA	Left	UI-11			
	5	6	Thermistor Dry contact RTD	Middle				
	5	6	0-10 V	Right				
12	7	8	0-20 mA	Left	UI-12			
	7	8	Thermistor Dry contact RTD	Middle				
	7	8	0-10 V	Right				
13	1	2	0-20 mA	Left	UI-13			
	1	2	Thermistor Dry contact RTD	Middle				
	1	2	0-10 V	Right				
14	3	4	0-20 mA	Left	UI-14			
	3	4	Thermistor Dry contact RTD	Middle				
	3	4	0-10 V	Right				
15	5	6	0-20 mA	Left	UI-15			
	5	6	Thermistor Dry contact RTD	Middle				
	5	6	0-10 V	Right				
16	7	8	0-20 mA	Left	UI-16			
	7	8	Thermistor Dry contact RTD	Middle				
	7	8	0-10 V	Right				



Universal Output Mode Select (Jumper Position of Pins)

Appendix B: TV-PSM wire lists

Point/ Cable#	Universal Outs (+)	(G)	Output Type	Jumper Position of Plns	I/O	Sensor code	Equipment Name	Point Name
1	1	2	0-20 mA	Left	U0-1			
			0-10 Vdc	Middle				
			Relay	Right				
2	3	4	0-20 mA	Left	U0-2			
			0-10 Vdc	Middle				
			Relay	Right				
3	5	6	0-20 mA	Left	U0-3			
			0-10 Vdc	Middle				
			Relay	Right				
4	7	8	0-20 mA	Left	U0-4			
			0-10 Vdc	Middle				
			Relay	Right				
5	1	2	0-20 mA	Left	U0-5			
			0-10 Vdc	Middle				
			Relay	Right				
6	3	4	0-20 mA	Left	U0-6			
			0-10 Vdc	Middle				
			Relay	Right				
7	5	6	0-20 mA	Left	U0-7			
			0-10 Vdc	Middle				
			Relay	Right				
8	7	8	0-20 mA	Left	U0-8			
			0-10 Vdc	Middle				
			Relay	Right				

Document revision history

Important changes to this document are listed below. Minor changes such as typographical or formatting errors are not listed.

Date	Topic	Change description	Code*
		No changes yet.	

* For internal use only



Carrier ©2022 · Catalog No. 11-808-884-01 · 6/28/2022

Free Manuals Download Website

<http://myh66.com>

<http://usermanuals.us>

<http://www.somanuals.com>

<http://www.4manuals.cc>

<http://www.manual-lib.com>

<http://www.404manual.com>

<http://www.luxmanual.com>

<http://aubethermostatmanual.com>

Golf course search by state

<http://golfingnear.com>

Email search by domain

<http://emailbydomain.com>

Auto manuals search

<http://auto.somanuals.com>

TV manuals search

<http://tv.somanuals.com>