

40GRQ / 38GRQ
 High--Wall Ductless Split System
 Sizes 09 to 18



Owner's Manual



NOTE: Read the entire instruction manual before starting the installation.

TABLE OF CONTENTS

	PAGE
SAFETY CONSIDERATIONS	2
SYSTEM REQUIREMENTS	2
Working temperature range	3
Model numbers	3
Parts name	4
Instructions - programming remote and air conditioner	5
Remote controller	6
Lost or damaged remote control	16
CLEANING AND MAINTENANCE	17
Troubleshooting	19
Installation diagram	23
Tools for installation	24
INDOOR UNIT INSTALLATION	26
OUTDOOR UNIT INSTALLATION FOR SINGLE ZONE APPLICATIONS (REFER TO THE 38GJ OWNER'S MANUAL FOR MULTIZONE)	31
Vacuum pumping	34
Leakage detection	34
Checking installation	35
Testing unit operation	35
Configuring connection pipe	36
Pipe expanding method	38

NOTE TO EQUIPMENT OWNER:

Please read this Owner's Information Manual carefully before installing and using this appliance and keep this manual for future reference.

For your convenience, please record the model and serial numbers of your new equipment in the spaces provided. This information, along with the installation data and dealer contact information, will be helpful should your system require maintenance or service.

UNIT INFORMATION

Model # _____

Serial # _____

INSTALLATION INFORMATION

Date Installed _____

DEALERSHIP CONTACT INFORMATION

Company Name: _____

Address: _____

Phone Number: _____

Technician Name: _____

SAFETY CONSIDERATIONS

Installing, starting up, and servicing air-conditioning equipment can be hazardous due to system pressures, electrical components, and equipment location (roofs, elevated structures, etc.).

Only trained, qualified installers and service mechanics should install, start-up, and service this equipment.

Untrained personnel can perform basic maintenance functions such as cleaning coils. All other operations should be performed by trained service personnel.

When working on the equipment, observe precautions in the literature and on tags, stickers, and labels attached to the equipment.

Follow all safety codes. Wear safety glasses and work gloves. Keep quenching cloth and fire extinguisher nearby when brazing. Use care in handling, rigging, and setting bulky equipment.

Read these instructions thoroughly and follow all warnings or cautions included in literature and attached to the unit. Consult local building codes and National Electrical Code (NEC) for special requirements. Recognize safety information. This is the safety-alert symbol . When you see this symbol on the unit and in instructions or manuals, be alert to the potential for personal injury. Understand these signal words: DANGER, WARNING, and CAUTION. These words are used with the safety-alert symbol. DANGER identifies the most serious hazards which **will** result in severe personal injury or death. WARNING signifies hazards which **could** result in personal injury or death. CAUTION is used to identify unsafe practices which **may** result in minor personal injury or product and property damage. NOTE is used to highlight suggestions which **will** result in enhanced installation, reliability, or operation.

When you see this symbol on the unit and in instructions or manuals, be alert to the potential for personal injury. Understand these signal words: DANGER, WARNING, and CAUTION. These words are used with the safety-alert symbol. DANGER identifies the most serious hazards which **will** result in severe personal injury or death. WARNING signifies hazards which **could** result in personal injury or death. CAUTION is used to identify unsafe practices which **may** result in minor personal injury or product and property damage. NOTE is used to highlight suggestions which **will** result in enhanced installation, reliability, or operation.



WARNING

ELECTRICAL SHOCK HAZARD

Failure to follow this warning could result in personal injury or death.

Before installing, modifying, or servicing system, main electrical disconnect switch must be in the OFF position. There may be more than 1 disconnect switch. Lock out and tag switch with a suitable warning label.



WARNING



EXPLOSION HAZARD

Failure to follow this warning could result in death, serious personal injury, and/or property damage.

Never use air or gases containing oxygen for leak testing or operating refrigerant compressors. Pressurized mixtures of air or gases containing oxygen can lead to an explosion.



CAUTION

EQUIPMENT DAMAGE HAZARD

Failure to follow this caution may result in equipment damage or improper operation.

Do not bury more than 36 in. (914 mm) of refrigerant pipe in the ground. If any section of pipe is buried, there must be a 6 in. (152 mm) vertical rise to the valve connections on the outdoor units. If more than the recommended length is buried, refrigerant may migrate to the cooler buried section during extended periods of system shutdown. This causes refrigerant slugging and could possibly damage the compressor at start-up.

SYSTEM REQUIREMENTS

Allow sufficient space for airflow and servicing unit. See Fig. 1 for minimum required distances between unit and walls or ceilings.

Recommended Connection Method for Power and Communication Wiring (To minimize communication wiring interference)

Power Wiring:

The main power is supplied to the outdoor unit. The field supplied connecting cable from the outdoor unit to indoor unit consists of three (3) wires and provides the power for the indoor unit. Two wires are high voltage AC power and one is a ground wire.

Consult your local building codes and the NEC (National Electrical Code) or CEC (Canadian Electrical Code) for special requirements.

All wires must be sized per NEC or CEC and local codes. Use Electrical Data table MCA (minimum circuit amps) and MOC (maximum over current protection) to correctly size the wires and the disconnect fuse or breakers respectively.

Per caution note, only copper conductors with a minimum 300 volt rating and 2/64-inch thick insulation must be used.

Communication Wiring:

A separate shielded copper conductor only, with a minimum 300 volt rating and 2/64-inch thick insulation, must be used as the communication wire from the outdoor unit to the indoor unit.

To minimize voltage drop of the control wire, use the following wire size and maximum lengths shown in the chart below:

Wire Size	Length ft (m)
18 AWG	50 (15)
16 AWG	50 (15) to 100 (30)

When installing in an application where there is high electrical frequency all wires should be shielded.



CAUTION

EQUIPMENT DAMAGE HAZARD

Failure to follow this caution may result in equipment damage or improper operation.

- Wires should be sized based on NEC and local codes.
- Use copper conductors only with a minimum 300 volt rating and 2/64 inch thick insulation.

Working temperature range

	Indoor side DB/WB(°F/°C)	Outdoor side DB/WB(°F/°C)
Maximum cooling		115/75(46.1/23.9)
Maximum heating	80/-(26.7/-)	75/64.9(23.9/18.3)

NOTICE:

- The operating temperature range (outdoor temperature) for cooling only unit is -0.4°F(-18°C) ~114.8°F(46°C) ; for heat pump unit is -22°F(-30°C)~ 72.5°F(24°C)

Model Numbers

System Tons	System Btuh	Volt-Ph@ 60Hz	Indoor Model Number	Outdoor Model Number Single Zone	Indoor unit Color
0.75	9,000	208/230-1	40GRQB09B--3	38GRQB09---3	Gray
0.75	9,000	208/230-1	40GRQB09H--3	38GRQB09---3	White
1	12,000	208/230-1	40GRQB12B--3	38GRQB12---3	Gray
1	12,000	208/230-1	40GRQB12H--3	38GRQB12---3	White
1.5	18,000	208/230-1	40GRQB18B--3	38GRQB18---3	Gray
1.5	18,000	208/230-1	40GRQB18H--3	38GRQB18---3	White

Model Number Reference

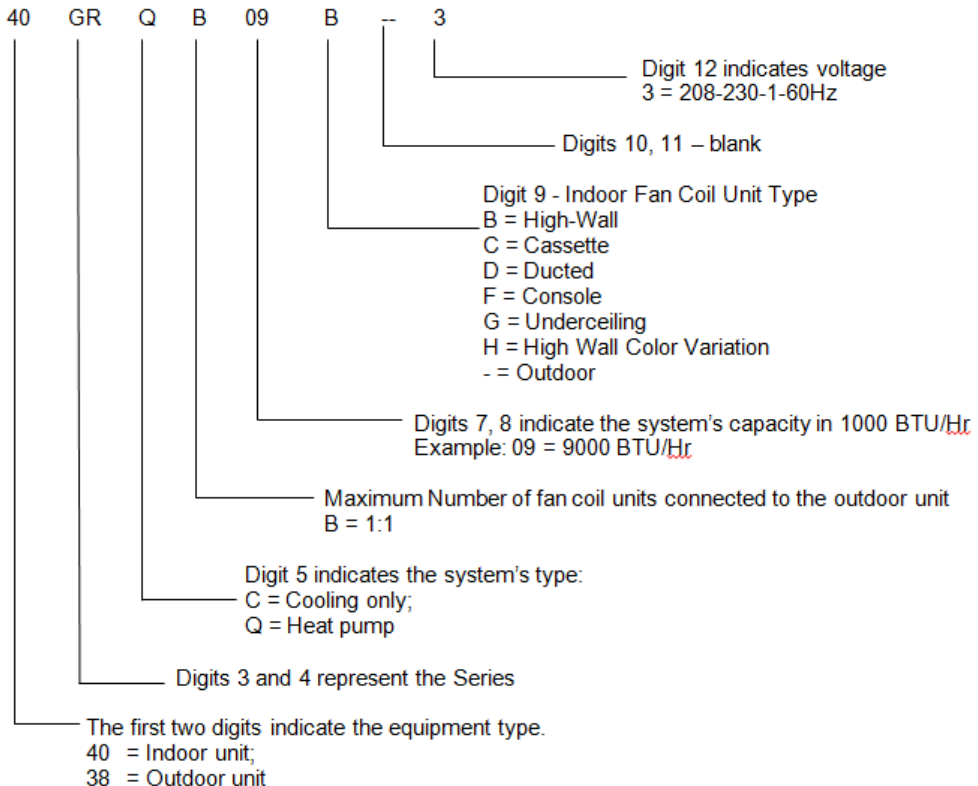

Parts name

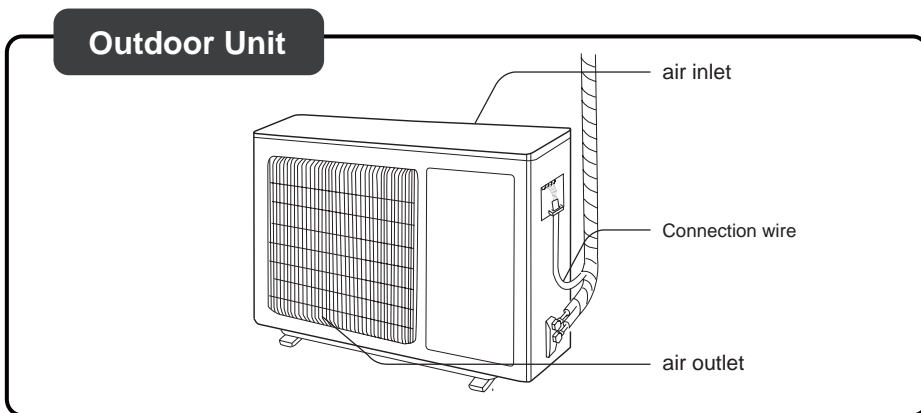
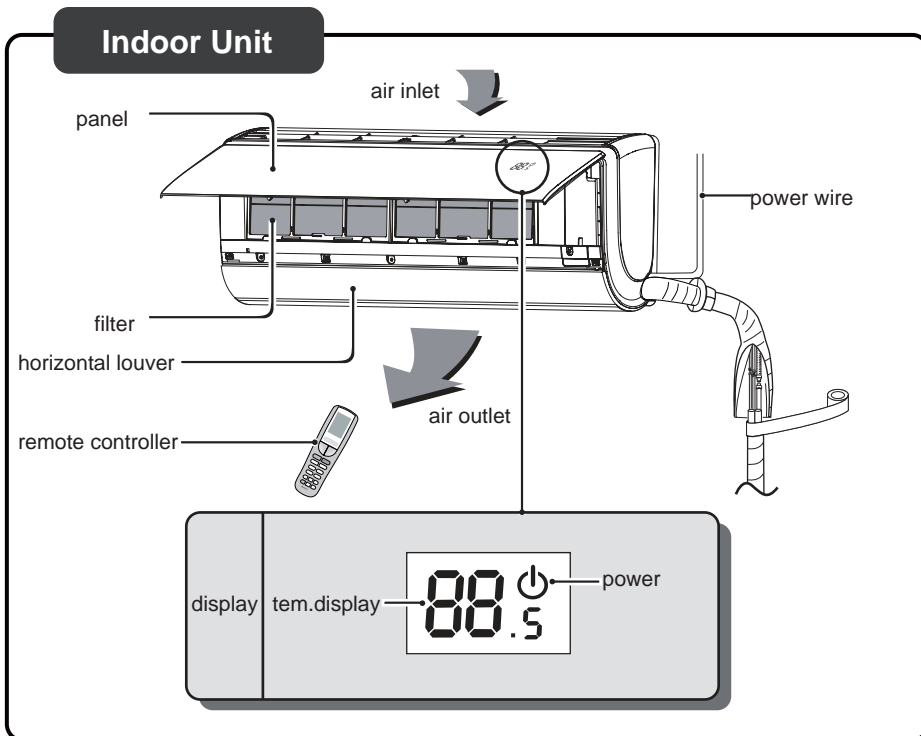

NOTE:
The illustration above is only a sketch. Different models may be slightly different.

Instructions - programming remote and air conditioner

The RF remote control must be synchronized with air conditioner prior to use. Follow the instructions below.

• Note •

- ▶ Synch remote controls within 6.5ft (2m) from air conditioning unit. While synching, the remote controller and air conditioner should be on standby status.
- ▶ Synching remote controller with air conditioner is a one-time requirement.

Programming remote control

- . Press standby status on air conditioner.
- . Stand near air conditioner while holding remote control. Press standby button on remote.
- . Synching will occur automatically.
- . If synch does not occur, move closer to unit and repeat steps.

Remote controller

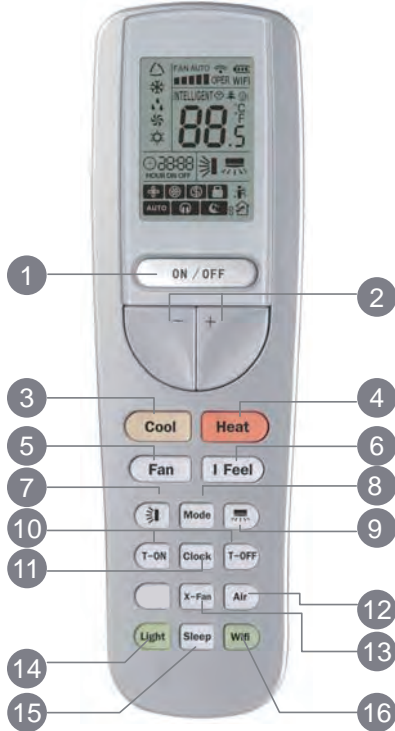

- 1 ON/OFF button
- 2 +/- button
- 3 Cool button
- 4 Heat button
- 5 Fan button
- 6 I FEEL button
- 7 up down swing button
- 8 Mode button
- 9 Left right swing button
- 10 T-ON/T-OFF button
- 11 Clock button
- 12 X-fan button
- 13 Air button
- 14 Light button
- 15 Sleep button
- 16 WIFI button

Introduction for icons on display screen

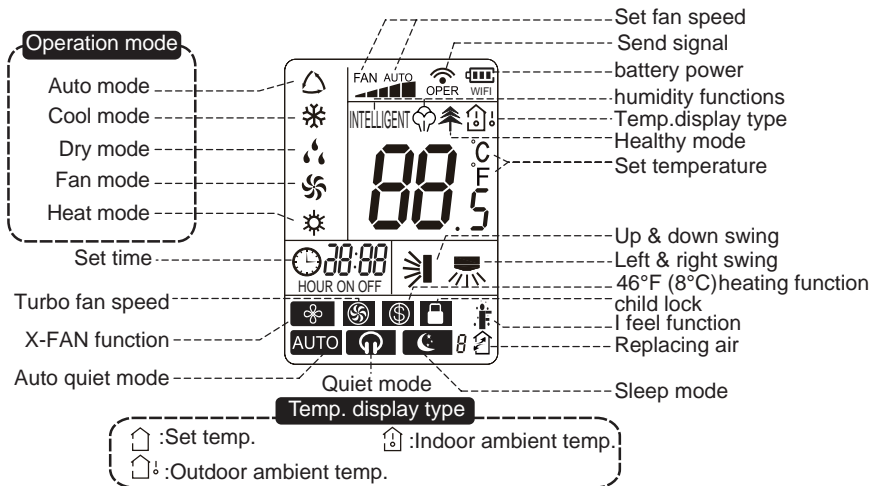

Matching Remote Control

The RF remote control must be synchronized with air conditioner prior to use. Follow the instructions below.

• Note •

- ▶ Synch remote controls within 6.5ft (2m) from air conditioning unit. While synching, the remote controller and air conditioner should be on standby status.
- ▶ Synching remote controller with air conditioner is a one-time requirement.

Programming remote control

- . Press standby status on air conditioner.
- . Stand near air conditioner while holding remote control. Press standby button on remote.
- . Synching will occur automatically.
- . If synch does not occur, move closer to unit and repeat steps.

REMOTE CONTROL FUNCTIONS

Note:

- After the air conditioner has been properly installed, you can use the remote control to operate the air conditioner. Press the power button on the remote control. The green indicator light will display on the air conditioner unit. Follow the instructions for using the remote control.

1 ON/OFF button

Use the ON/OFF remote button to turn on or turn off the air conditioner. The button on the remote will display ON when the air conditioner is on.

2 +/- button

The +/- button increases or decreases the temperature setting on the air conditioning unit. Hold the "+" or "-" for 2s to change the temperature setting. NOTE: Temperature setting can not be adjusted in "auto mode".

Press the "+" or "-" for setting and adjusting TIMER.

3 Cool button

Press the Cool button to operate in cool mode.

4 Heat button

Press the Heat button to operate in heat mode.

5 FAN button

Press the FAN button to adjust the fan circulation speed: low(■), low medium(■■), medium(■■■), medium high(■■■■), high(■■■■■), super, auto and quiet.





Note:

- Turbo function is not available under dry and auto mode.
- Automatically operate silent speed when starting sleep function.
- The unit operates at low speed under dry and auto dry mode. The speed can't be adjusted.
- Under AUTO speed, air conditioner will select proper fan speed automatically according to ambient temperature.





REMOTE CONTROL FUNCTIONS

6 I FEEL button

Press this button to start I FEEL function and "  " will be displayed on the remote controller. After this function is set, the remote controller will send the detected ambient temperature to the controller and the unit will automatically adjust the indoor temperature according to the detected temperature. Press this button again to close I FEEL function and "  " will disappear.

- Please put the remote controller near user when this function is set. Do not put the remote controller near the object of high temperature or low temperature in order to avoid detecting inaccurate ambient temperature.

7 button

- Under simple swing mode, press this button can turn on (display "  " icon) or turn off (not display "  " icon) left&right swing function.
- Under OFF status, press "+" button and "  " button simultaneously can switch between simple swing mode and fixed swing mode. During switching time, "  " icon on remote controller will flash twice.
- Under fixed-angle swing mode, press this button and the left and right swing status will change in the sequence as below:

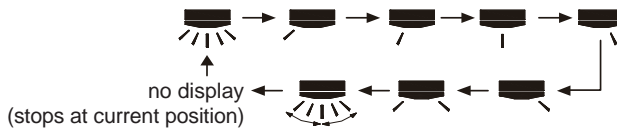

8 MODE button

Press this button to select your required operation mode.

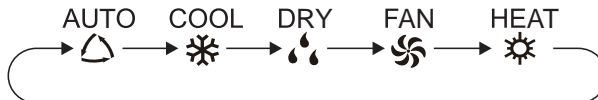

REMOTE CONTROL FUNCTIONS

- When selecting auto mode, air conditioner will operate automatically according to ambient temperature. Set temperature can't be adjusted and will not be displayed as well. Press "FAN" button can adjust fan speed. Press "☀" / "☂" button can adjust fan blowing angle.
- After selecting cool mode, air conditioner will operate under cool mode. Press "+" or "-" button to adjust set temperature. Press "FAN" button to adjust fan speed. Press "☀" / "☂" button to adjust fan blowing angle.
- When selecting dry mode, the air conditioner operates at low speed under dry mode. Under dry mode, fan speed can't be adjusted. Press "☀" / "☂" button to adjust fan blowing angle.
- When selecting fan mode, the air conditioner will only blow fan, Press "FAN" button to adjust fan speed. Press "☀" / "☂" button to adjust fan blowing angle.
- When selecting heating mode, the air conditioner operates under heat mode. Press "+" or "-" button to adjust set temperature. Press "FAN" button to adjust fan speed. Press "☀" / "☂" button to adjust fan blowing angle. (Cooling only unit won't receive heating mode signal. If setting heat mode with remote controller, press ON/OFF button can't start up the unit).

Note:

- For preventing cold air, after starting up heating mode, indoor unit will delay 1~5 minutes to blow air (actual delay time is depend on indoor ambient temperature).
- Set temperature range from remote controller: 16~30°C (61-86°F);

9

☂ button

- Under simple swing mode, press this button can turn on (display " ☂ " icon) or turn off (not display " ☂ " icon) up&down swing function.
- Under OFF status, press "+" button and "☂" button simultaneously can switch between simple swing mode and fixed swing mode. During switching time, " ☂ " icon on remote controller will flash twice.
- Under fixed swing mode, press this button and up and down swing status will change in the sequence as below:

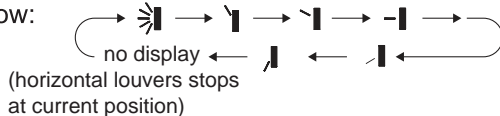

REMOTE CONTROL FUNCTIONS

10 T-ON/T-OFF button

- T-ON button

“T-ON” button can set the time for timer on. After pressing this button, "🕒" icon disappears and the word “ON” on remote controller blinks. Press “+” or “-” button to adjust T-ON setting. After each pressing “+” or “-” button, T-ON setting will increase or decrease 1min. Hold “+” or “-” button, 2s later, the time will change quickly until reaching your required time. Press “T-ON” to confirm it. The word “ON” will stop blinking. "🕒" icon resumes displaying. Cancel TIMER ON: Under the condition that T-ON is started up, press “T-ON” button to cancel it.

- T-OFF button

“T-OFF” button can set the time for timer off. After pressing this button, "🕒" icon disappears and the word "OFF" on remote controller blinks. Press "+" or "-" button to adjust T-OFF setting. After each pressing "+" or "-" button, T-OFF setting will increase or decrease 1min. Hold "+" or "-" button, 2s later, the time will change until reaching your required time. Press “T-OFF” to confirm it. The word “ON” will “OFF” will stop blinking. "🕒" icon resumes displaying. Cancel T-OFF. Under the condition that T-OFF is started up, press “T-OFF” button to cancel it.

Note:

- Under on and off status, you can set T-OFF or T-ON simultaneously.
- Before setting T-ON or T-OFF, please adjust the clock time.
- After starting up T-ON or T-OFF, set the constant circulating valid. After that, air conditioner will be turned on or turned off according to setting time. ON/OFF button has no effect on setting. If you don't need this function, please use remote controller to cancel it.

11 CLOCK button

Press this button to set clock time. "🕒" icon on remote controller will blink. Press "+" or "-" button within 5s to set clock time. Each pressing of "+" or "-" button, clock time will increase or decrease 1 minute. Hold "+" or "-" button, 2s later, time will change quickly. Release this button when reaching your required time. Press “CLOCK” button to confirm the time. "🕒" icon stops blinking.

Note:

- Clock time adopts 24-hour mode.
- The interval between two operations can't exceeds 5s. Otherwise, remote controller will quit setting status. Operation for TIMER ON/TIMER OFF is the same.

REMOTE CONTROL FUNCTIONS

12 X-FAN button

Pressing this button in COOL or DRY mode, the icon "☼" is displayed and the indoor fan will continue operation for 2 minutes in order to dry the indoor unit even though you have turned off the unit. After energization, X-FAN OFF is defaulted. X-FAN is not available in AUTO, FAN or HEAT mode.

This function indicates that moisture on evaporator of indoor unit will be blown after the unit is stopped to avoid mould.

- Having set X-FAN function on: After turning off the unit by pressing ON/OFF button indoor fan will continue running for about 2 min. at low speed. In this period, press X-FAN button to stop indoor fan directly.
- Having set X-FAN function off: After turning off the unit by pressing ON/OFF button, the complete unit will be off directly.

13 Air button

Press this button to select your required operation mode.

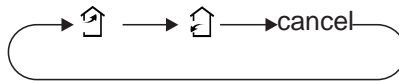

Note:there is no this function for this unit. If press this button,the main unit will click, but it also runs under original status.

14 LIGHT button

Pressing this button to turn off display light on indoor unit. Press this button again to turn on display light.

15 SLEEP button

- Pressing this button can select Sleep 1, Sleep 2,Sleep 3, Sleep 4 or cancel Sleep circularly as below:

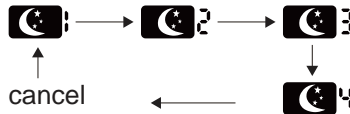

REMOTE CONTROL FUNCTIONS

- In Sleep 1 and Sleep 2, the air conditioner will run according to a group of presetting temperature curves.
- Sleep 3 - the sleep curve setting under DIY Sleep mode:
 - (1) Under Sleep 3 mode, long press "AIR" button, the remote controller will enter the setting of personalized sleep. In this case, the timer zone of remote controller will display "1 hr" and the set temperature zone "88" will display the corresponding temperature of the last set sleep curve and blink (The first entering will display according to the initial curve setting value of manufacturer);
 - (2) Press "+" and "-" button to adjust the corresponding temperature. After adjusting, press "AIR" button to confirm it;
 - (3) At this time, the timer time on the remote controller will increase automatically by 1hr (that is "2 hr" or "3 hr" ... or "8 hr"). The set temperature zone "88" will display the corresponding temperature of the last set sleep curve and blink;
 - (4) Repeat step(2) and step (3) until 8-hour temperature setting is finished, then the sleep curve is set successfully. After that, remote controller will resume displaying the original timer time and temperature zone will resume displaying the original set temperature.
- Sleep 3 - the sleep curve inquiry under DIY Sleep mode:

User can inquire the set sleep curve according to the setting method of sleep curve. Enter the setting of personalized sleep but do not change the temperature. Then press "AIR" button to confirm the setting.

Note: In the above setting or inquiry procedure, if there is no button pressing within 10s, remote controller will automatically exit the sleep curve setting and resume the HEATING button is pressed during the setting or inquiry procedure, remote controller original display. If ON/OFF, MODE, TIMER, HUMIDIFY, SLEEP, COOLING or will also exit the sleep curve setting.
- Sleep 4 is Siesta mode. The set temperature will change automatically according to the features of siesta.
- Sleep function will be disabled if the air condition is restarted after power failure; when sleep function is turned on, quite fan speed will be also turned on.
- Sleep function can not be set in AUTO mode.

16 Wifi button

- Press this button 3s can set wifi function on or OFF.
- At OFF status, press mode button and wifi button, can reset wifi mode parameter. and open wifi function.

REMOTE CONTROL FUNCTIONS - COMBINATION KEYS

X-FAN



This function indicates moisture levels will blow away after unit stops to prevent mold.

1. When X-FAN function is on: Press ON/OFF button (on remote) to turn off the unit. The indoor fan will run for approximately 2 minutes at low speed. Press X FAN button to stop indoor fan.
2. When X-FAN function is off: Press ON/OFF button (on remote) to turn off complete unit.

Auto Run

The Auto Run mode automatically adjusts to the room's temperature. The LCD on the unit does not show the temperature.

Lock

Press "+" and "-" buttons simultaneously to lock or unlock the remote control. If remote control is locked, the icon  will display; when this occurs press any button on the remote three times. The lock  will disappear. If the remote is not locked, the lock  will not appear.

Fahrenheit & Centigrade

Make sure the remote control is off. Press MODE and press "C" or "F" to switch between fahrenheit and centigrade.

Operating unit

1. After initializing unit, press the ON/OFF button on remote control to turn on air conditioner.
2. Press "MODE" on remote control to select mode: AUTO, COOL, DRY, FAN, or HEAT.
3. Press "+" or "-" button to set temperature. (Temperature can't be adjusted under auto mode).
4. Press "FAN" button to set fan speed: low, low medium, medium, medium high, high, super, auto and quiet speed.
5. Press "SWING" button to select fan blowing angle.

Replace batteries in remote control

1. Press the back side of remote control marked with "OPEN", as shown in the fig, and then push out the cover of battery box along the arrow direction.
2. Replace two AAA 1.5V dry batteries, and make sure the position of "+" polar and "-" polar are correct.
3. Reinstall the cover of battery box.

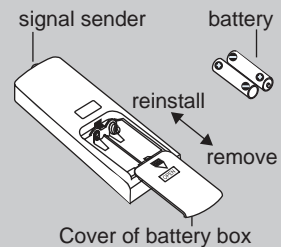

Battery level will be displayed on the remote controller. When "  " is flickering, please replace the batteries, otherwise, remote controller can't operate normally.

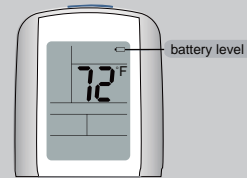

NOTICE

- During operation, point the remote control signal sender at the receiving window on indoor unit.
- The distance between signal sender and receiving window should be no more than 26ft(8m), and there should be no obstacles between them.
- Signal may be interfered by a fluorescent lamp or wireless telephone; remote control should be close to indoor unit during operation.
- Replace new batteries of the same model when replacement is required.
- When you don't use remote control for a long time, please remove the batteries.
- If the display on remote control is fuzzy or there's no display, please replace batteries.

Lost or damaged remote control

If the remote control is lost or damaged, the air conditioner can be turned off directly from the unit. Lift the display panel on top of the air conditioner, then press the AUX button to turn on or turn off the air conditioner. If the air conditioner is on, it will operate through the AUTO MODE.

As shown in the fig. Open panel, press aux. button to turn on or turn off the air conditioner. When the air conditioner is turned on, it will operate in auto mode.

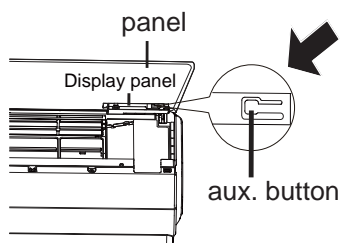

 Warning: Use insulated object to press the auto button

CLEANING AND MAINTENANCE

WARNING

- Turn off the air conditioner and disconnect the power before cleaning the air conditioner to avoid electric shock.
- Do not wash the air conditioner with water to avoid electric shock.
- Do not use volatile liquid to clean the air conditioner.

Clean surface of indoor unit

When the surface of indoor unit is dirty, it is recommended to use a soft dry cloth or wet cloth to wipe it.

NOTICE:

- Do not remove the panel when cleaning it.

CLEANING AND MAINTENANCE

Clean filter

- 1 Open panel**
Open the panel to a certain angle (less than 60°; do not open the panel too forcibly) along the arrow direction from the two sides of panel.



- 2 Remove filter**
Remove the filter as indicated in the fig.

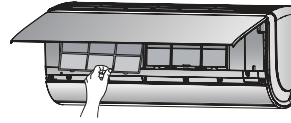

- 3 Clean filter**
- Use dust catcher or water to clean the filter.
 - When the filter is very dirty, use water (below 113°F (45°C)) to clean it, and then put it in a shady and cool place to dry.

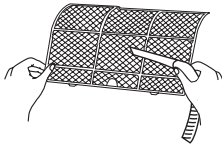

- 4 Install filter**
Install the filter and then close the panel cover tightly.

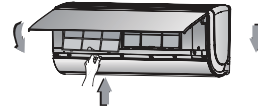

WARNING

- Clean filter every three months. If dust accumulates quickly, clean filter more frequently.
- After removing the filter, do not touch fins to avoid injury.
- Do not use fire or hair dryer to dry the filter to avoid deformation or fire hazard.

CLEANING AND MAINTENANCE

Preparing to clean filter

1. Check whether air inlets and air outlets are blocked.
2. Check whether air switch, plug and socket are in good condition.
3. Check whether filter is clean.
4. Check whether mounting bracket for outdoor unit is damaged or corroded.
If yes, please contact dealer.
5. Check whether drainage pipe is damaged.

Cleaning unit panel and filter

1. Disconnect power supply.
2. Clean filter and indoor unit's panel.
3. Check whether mounting bracket for outdoor unit is damaged or corroded.
If yes, please contact dealer.

Notice for recovery

1. Many packing materials are recyclable materials.
Please dispose them in appropriate recycling unit.
2. To dispose the air conditioner, please contact local dealer or consultant service center for the correct disposal method.

Troubleshooting

Please identify problems and possible solutions for requesting maintenance assistance. If problem can not be resolved by following the steps described, contact your dealer or a qualified professional.

Problem	Possible cause	Solution
Indoor unit can't receive remote control's signal or remote control has no action.	<ul style="list-style-type: none"> • Determine if interference has occurred due to severe static electricity or voltage surge. 	<ul style="list-style-type: none"> • Remove the plug from the wall outlet. Wait three minutes. Reinsert the plug into the outlet, then turn the unit on.
	<ul style="list-style-type: none"> • Determine if the remote control is within the signal receiving range. 	<ul style="list-style-type: none"> • Make sure the remote control is within the receiving range: 26.2ft(8m).
	<ul style="list-style-type: none"> • Determine if other obstacles are preventing signal receptivity. 	<ul style="list-style-type: none"> • Eliminate possible obstacles that can block signal reception.
	<ul style="list-style-type: none"> • Unit not responding to the remote control. 	<ul style="list-style-type: none"> • Select proper angle and point the remote controller at the receiving window on indoor unit.
	<ul style="list-style-type: none"> • Determine if remote control is working properly. Possible problems: low sensitivity, fuzzy display or no display. 	<ul style="list-style-type: none"> • Replace batteries if remote control performs slowly or poorly.
	<ul style="list-style-type: none"> • No display when operating remote controller? 	<ul style="list-style-type: none"> • Check whether remote controller appears to be damaged. If yes, replace it.
	<ul style="list-style-type: none"> • Fluorescent lamp in room? 	<ul style="list-style-type: none"> • Take the remote controller close to indoor unit. • Turn off the fluorescent lamp and then try it again.
Air conditioner unit does not release air.	<ul style="list-style-type: none"> • Air inlet or air outlet of indoor unit is blocked? 	<ul style="list-style-type: none"> • Eliminate obstacles.
	<ul style="list-style-type: none"> • Under heating mode, indoor temperature is reached to set temperature? 	<ul style="list-style-type: none"> • After reaching to set temperature, indoor unit will stop blowing out air.
	<ul style="list-style-type: none"> • Heating Mode not starting right after setting it in the remote control. 	<ul style="list-style-type: none"> • In order to prevent blowing out cold air, indoor unit will be started after delaying for several minutes, which is a normal phenomenon.

Troubleshooting

Problems	Possible Causes	Solutions
Air conditioner does not start.	• Power failure?	• Wait until power recovery.
	• Is plug loose?	• Reinsert the plug.
	• Air switch trips off or fuse is burnt out?	• Ask professional to replace air switch or fuse.
	• Wiring has malfunction?	• Ask professional to replace it.
	• Unit has restarted immediately after stopping operation?	• Wait for 3min, and then turn on the unit again.
	• Is remote control function setting correct?	• Reset the function.
Mist is coming out of indoor unit's air outlet.	• Indoor temperature and humidity is high?	• Occurs if indoor air rapidly cools down. After a while, indoor temperature and humidity will be decrease and mist will disappear.
Set temperature can't be adjusted.	• Unit is operating under auto mode?	• Temperature can't be adjusted under auto mode. Please switch the operation mode if you need to adjust temperature.
	• Your required temperature exceeds the set temperature range?	• Set temperature range: 16°C ~30°C .
Cooling or heating is inaccurate.	• Voltage is too low?	• Wait until the voltage resumes normal.
	• Filter is dirty?	• Clean the filter.
	• Set temperature is in proper range?	• Adjust temperature to proper range.
	• Door and window are open?	• Close door and window.

Troubleshooting

Problems	Possible causes	Solutions
Foul odors	<ul style="list-style-type: none"> • Sources of foul odors: furniture, cigarettes, etc. 	<ul style="list-style-type: none"> • Eliminate the odor source. • Clean the filter.
Air conditioner suddenly operates normally without repair	<ul style="list-style-type: none"> • Occurs when there's interference: thunder, wireless devices, etc. 	<ul style="list-style-type: none"> • Disconnect power, put back power, and then turn on the unit again.
Outdoor unit has vapor	<ul style="list-style-type: none"> • Heating mode is turned on? 	<ul style="list-style-type: none"> • During defrosting under heating mode, it may generate vapor, which is a normal occurrence.
"Water flowing" noise	<ul style="list-style-type: none"> • Air conditioner unexpectedly turns on or off and emits an unfamiliar sound. 	<ul style="list-style-type: none"> • The noise is the sound of refrigerant flowing inside the unit, which is a normal phenomenon.
Cracking noise	<ul style="list-style-type: none"> • The air conditioner makes an unusual cracking sound. 	<ul style="list-style-type: none"> • This is the sound of friction caused by expansion and/or contraction of panel or other parts due to the change of temperature.

Troubleshooting

Error Codes

- When air conditioner status is abnormal, temperature indicator on indoor unit will blink to display corresponding error code. Please refer to below list for identification of error code.

Error code	Troubleshooting
E5	It can be eliminated after restarting the unit. If not, contact qualified professionals for service.
E6	It can be eliminated after restarting the unit. If not, contact qualified professionals for service.
E8	It can be eliminated after restarting the unit. If not, contact qualified professionals for service.
U8	It can be eliminated after restarting the unit. If not, contact qualified professionals for service.
H6	It can be eliminated after restarting the unit. If not, contact qualified professionals for service.
C5	Please contact qualified professionals for service.
F1	Please contact qualified professionals for service.
F2	Please contact qualified professionals for service.

Note: If there are other error codes, please contact qualified professionals for service.



WARNING

- If below incidences occurs, please turn off air conditioner and disconnect power immediately, and then contact the dealer or qualified professionals for service.
 - Power cord is overheating or damaged.
 - There's abnormal sound during operation.
 - Air switch trips off frequently.
 - Air conditioner gives off burning smell.
 - Indoor unit is leaking.
- Do not repair or refit the air conditioner by yourself.
- If the air conditioner operates under abnormal conditions, it may cause malfunction, electric shock or fire hazard.

Installation diagram

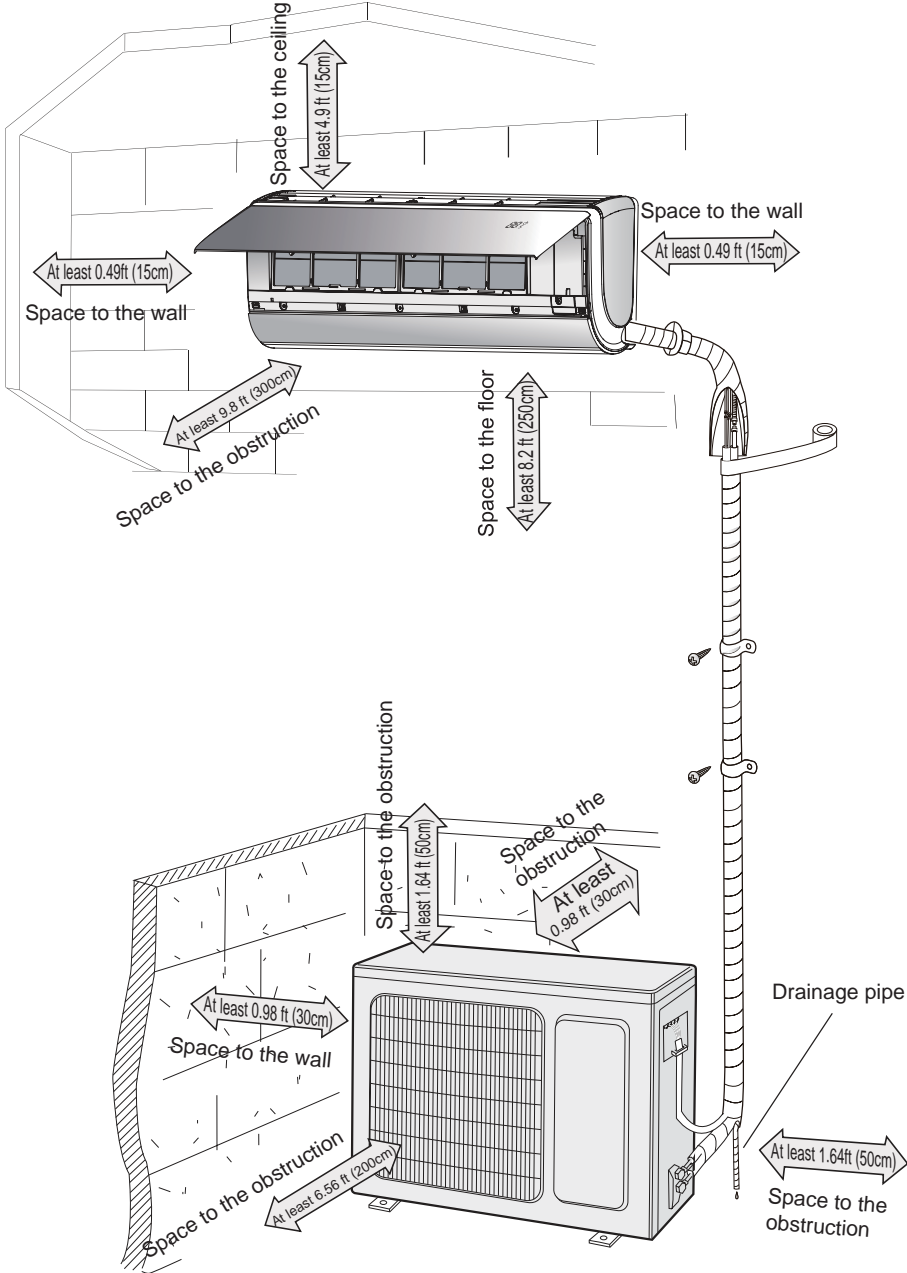

Tools for installation

1 Level meter	2 Screw driver	3 Impact drill
4 Drill head	5 Pipe expander	6 Torque wrench
7 Open-end wrench	8 Pipe cutter	9 Leakage detector
10 Vacuum pump	11 Pressure meter	12 Universal meter
13 Inner hexagon spanner		14 Measuring tape

Note:

- Please contact the local agent for installation.
- Don't use unqualified power cord.

INSTALLATION TIPS

Basic requirement

Installing the unit in the following places may cause malfunction. If it is unavoidable, please consult the local dealer:

1. The place with strong heat sources, vapors, flammable or explosive gas, or volatile objects spread in the air.
2. The place with high-frequency devices (such as welding machine, medical equipment).
3. The place near coast area.
4. The place with oil or fumes in the air.
5. The place with sulfureted gas.
6. Other places with special circumstances.
7. The appliance shall not be installed in the laundry.

Indoor unit

1. There should be no obstruction near air inlet and air outlet.
2. Select a location where the condensation water can be dispersed easily and won't affect other people.
3. Select a location which is convenient to connect the outdoor unit and near the power socket.
4. Select a location which is out of reach for children.
5. The location should be able to withstand the weight of indoor unit and won't increase noise and vibration.
6. The appliance must be installed 2.5m above floor.
7. Don't install the indoor unit right above the electric appliance.
8. Please try your best to keep way from fluorescent lamp.

Outdoor unit

1. Select a location where the noise and outflow air emitted by the outdoor unit will not affect neighborhood.
2. The location should be well ventilated and dry, so the outdoor unit won't be exposed directly to sunlight or strong wind.
3. The location should be able to withstand the weight of outdoor unit.
4. Make sure that the installation follows the requirement of installation dimension diagram.
5. Select a location which is out of reach for children and far away from animals or plants. If it is unavoidable, please add the fence for safety purpose.

Grounding requirement

1. The Air conditioner must be properly grounded to avoid electric shock.
2. The yellow-green wire in air conditioner is grounding wire, which can't be used for other purposes.
3. The grounding resistance should comply with national electric safety regulations.
4. The appliance must be positioned so that the plug is accessible.
5. An all-pole disconnection switch having a contact separation of at least 1/8 in (3mm) in all poles should be connected in fixed wiring. For models with a power plug, make sure the plug is within reach after installation ;
6. Including an air switch with suitable capacity, please note the following table. Air switch should be included magnet buckle and heating buckle function, it can protect the circuit-short and overload. (Caution: please do not use the fuse only for protect the circuit)

Air-conditioner	Air switch capacity
09K	15A
12K	20A
18K	30A

INDOOR UNIT INSTALLATION

Step one: choosing installation location

Recommend the installation location to the client and then confirm it with the client.

Step two: install wall-mounting frame

1. Hang the wall-mounting frame on the wall; adjust it in horizontal position with the level meter and then point out the screw fixing holes on the wall.
2. Drill the screw fixing holes on the wall with impact drill (the specification of drill head should be the same as the plastic expansion particle) and then fill the plastic expansion particles in the holes.
3. Fix the wall-mounting frame on the wall with tapping screws (ST4.2X25TA) and then check if the frame is firmly installed by pulling the frame. If the plastic expansion particle is loose, please drill another fixing hole nearby.

Step three: open piping hole

1. Choose the position of piping hole according to the direction of outlet pipe. The position of piping hole should be a little lower than the wall-mounted frame, shown as below.

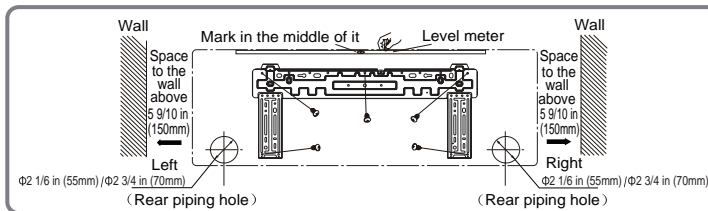

2. Open a piping hole with the diameter of $\Phi 2 \frac{1}{6}$ in (55mm) or $\Phi 2 \frac{3}{4}$ in (70mm) on the selected outlet pipe position. In order to drain smoothly, slant the piping hole on the wall slightly downward to the outdoor side with the gradient of 5-10°.

INDOOR UNIT INSTALLATION

Note:

- Pay attention to dust prevention and take relevant safety measures when opening the hole.
- The plastic expansion particles are not provided and should be bought locally.

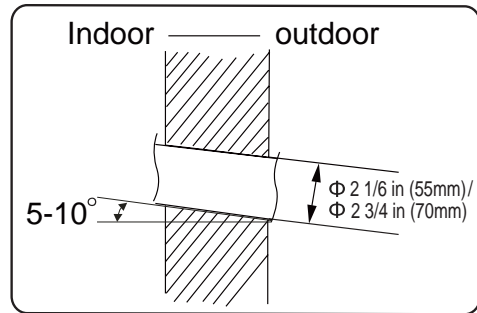

Step four: outlet pipe

1. The pipe can be led out in the direction of right, rear right, left or rear left.

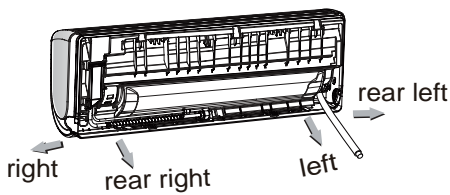

2. When select leading out the pipe from left or right, please cut off the corresponding hole on the bottom case.

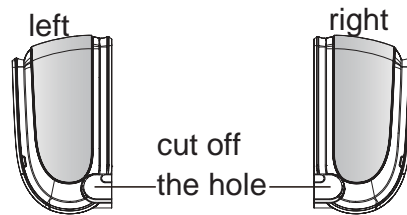

Step five: connect the pipe of indoor unit

1. Aim the pipe joint at the corresponding bellmouth.
2. Pretightening the union nut with hand.

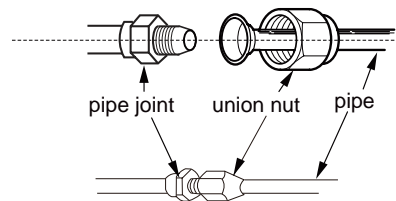

3. Adjust the torque force by referring to the following sheet. Place the open-end wrench on the pipe joint and place the torque wrench on the union nut. Tighten the union nut with torque wrench.

INDOOR UNIT INSTALLATION

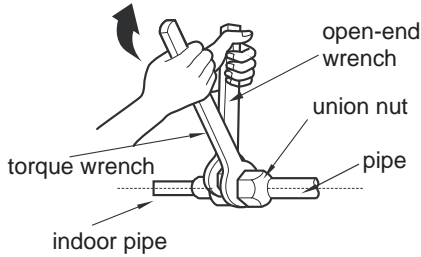

Hex nut diameter	Tightening torque
Φ 1/4 in (6 mm)	20.34~27.12 ft.lb(15~20 N.m)
Φ 3/8 in (9.52 mm)	40.68~54.24 ft.lb(30~40 N.m)
Φ 1/2 in (12 mm)	61.02~74.58 ft.lb(45~55 N.m)
Φ 5/8 in (16 mm)	81.36~88.14 ft.lb(60~65 N.m)
Φ 3/4 in (19 mm)	94.93~101.7 ft.lb(70~75 N.m)

4. Wrap the indoor pipe and joint of connection pipe with insulating pipe, and then wrap it with tape.

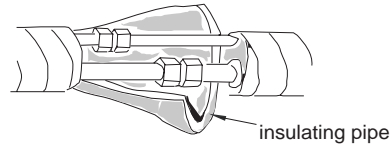

Step six: install drain hose

1. Connect the drain hose to the outlet pipe of indoor unit.

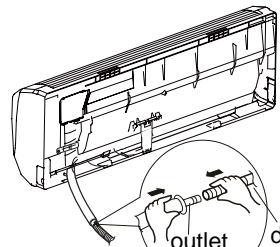

2. Bind the joint with tape.

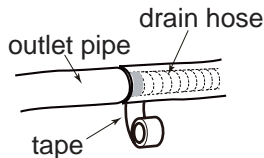

Note:

- Add insulating pipe in the indoor drain hose in order to prevent condensation.
- The plastic expansion particles are not provided.

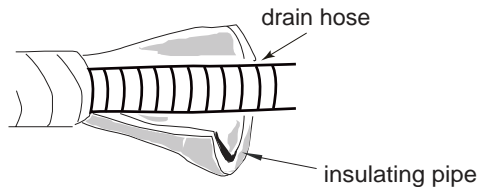

Step seven: connect wire of indoor unit

1. Open the panel, remove the screw on the wiring cover and then take down the cover.

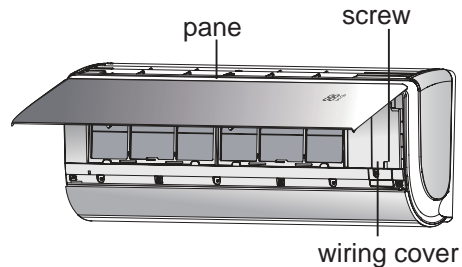

INDOOR UNIT INSTALLATION

2. Make the power connection wire go through the cable-cross hole at the back of indoor unit and then pull it out from the front side.

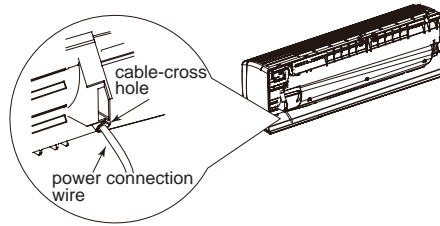

3. Remove the wire clip; connect the power connection wire to the wiring terminal according to the color; tighten the screw and then fix the power connection wire with wire clip. After finishing wiring, clamp the grounding wire (yellow-green wire) into the wire-crossing groove as shown in the following figure, in order to avoid pressing the wire when closing the electric box cover.

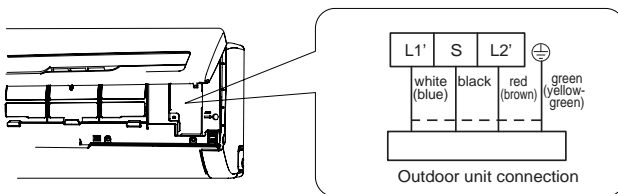

4. Put wiring cover back and then tighten the screw
5. Close the panel.

Note:

- All wires of indoor unit and outdoor unit should be connected by a professional.
- If the length of power connection wire is insufficient, please contact the supplier for a new one. Avoid extending the wire by yourself.
- For the air conditioner with plug, the plug should be reachable after finishing installation.
- For the air conditioner without plug, an air switch must be installed in the line. The air switch should be all-pole parting and the contact parting distance should be more than 2/17 in (3mm).

INDOOR UNIT INSTALLATION

Step eight: bind up pipe

1. Bind up the connection pipe, power cord and drain hose with the band.

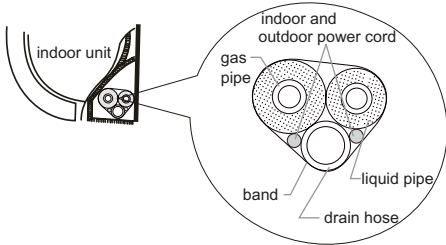

2. Reserve a certain length of drain hose and power cord for installation when binding them. When binding to a certain degree, separate the indoor power and then separate the drain hose.

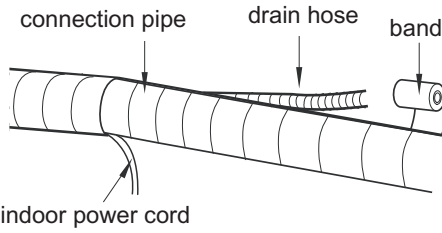

3. Bind them evenly.
4. The liquid pipe and gas pipe should be bound separately at the end.

Note:

- The power cord and control wire can't be crossed or winding.
- The drain hose should be bound at the bottom.

Step nine: hang the indoor unit

1. Put the bound pipes in the wall pipe and then make them pass through the wall hole.
2. Hang the indoor unit on the wall-mounting frame.
3. Stuff the gap between pipes and wall hole with sealing gum.
4. Fix the wall pipe.
5. Check if the indoor unit is installed firmly and closed to the wall.

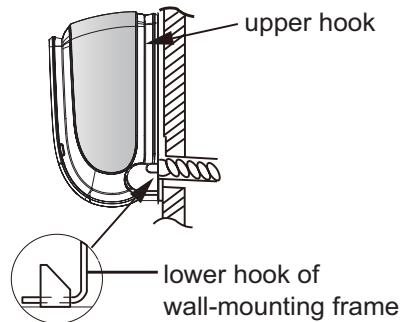
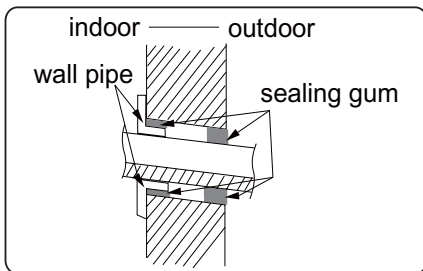

Note:

- Do not bend the drain hose too excessively in order to prevent blocking.

CAUTION NOTE



CAUTION

EQUIPMENT DAMAGE HAZARD

Failure to follow this caution may result in equipment damage or improper operation.

In regions with snowfall and cold temperatures, avoid installing the outdoor unit in areas where it can be covered by snow. If the outdoor unit is installed in areas where heavy snow is expected, a field supplied ice or snow stand and/or field supplied--installed wind baffle should be installed to protect the unit from snow accumulation and/or blocked air intake. Blocking the air intake may result in reduced airflow, significantly reduced performance and damage to the equipment.

OUTDOOR UNIT INSTALLATION FOR SINGLE ZONE APPLICATIONS (REFER TO THE 38GJ OWNER'S MANUAL FOR MULTIZONE)

Step one: fix the support of outdoor unit

(select it according to the actual installation situation)

1. Select installation location according to the house structure.
2. Fix the support of outdoor unit on the selected location with expansion screws.
3. Make sure the outdoor unit is mounted level and off the ground in areas where there is snow.

Note:

- Take sufficient protective measures when installing the outdoor unit.
- Make sure the support can withstand at least four times of the unit weight.
- The outdoor unit should be installed at least 1 1/6 in (3cm) above the floor in order to install drain joint.
- For the unit with cooling capacity of 3 HP~6 5/7 HP (2300W~5000W), 6 expansion screws are needed;
for the unit with cooling capacity of 8 HP~10 3/4 HP (6000W~8000W), 8 expansion screws are needed;
for the unit with cooling capacity of 13 2/5 HP~21 1/2 HP (10000W~16000W), 10 expansion screws are needed.

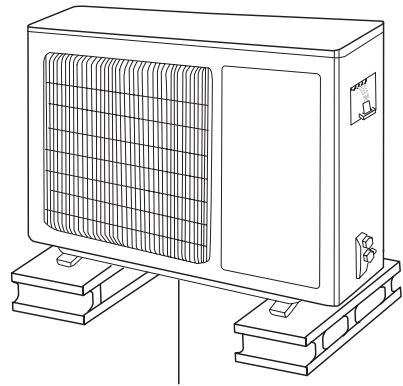

at least 1 1/6 in (3cm) above the floor

Step two: install drain joint (Only for cooling and heating unit)

1. Connect the outdoor drain joint into the hole on the chassis, as shown in the picture below.
2. Connect the drain hose into the drain vent.

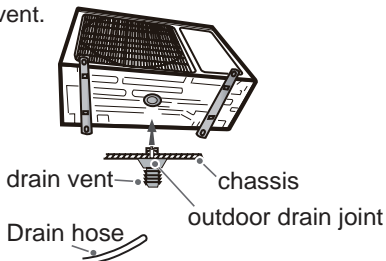

Step three: fix outdoor unit

1. Place the outdoor unit on the support.
2. Fix the foot holes of outdoor unit with bolts.

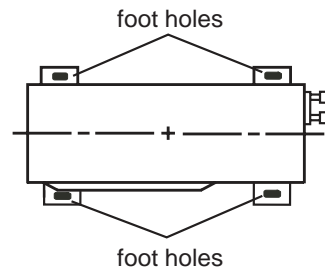

OUTDOOR UNIT INSTALLATION FOR SINGLE ZONE APPLICATIONS (REFER TO THE 38GJ OWNER'S MANUAL FOR MULTIZONE)

Step four: connect indoor and outdoor pipes

1. Remove the screw on the right handle of outdoor unit and then remove the handle.

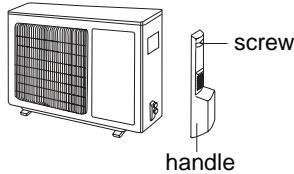

3. Pretightening the union nut with hand.

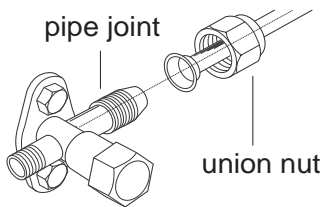

2. Remove the screw cap of valve and aim the pipe joint at the bellmouth of pipe.

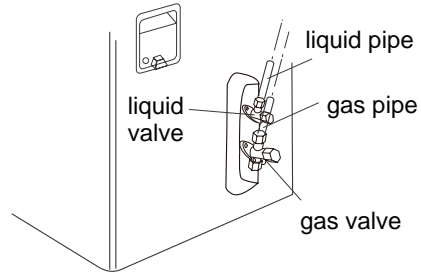

4. Tighten the union nut with torque wrench by referring to the sheet below.

Hex nut diameter	Tightening torque
Φ 1/4 in (6 mm)	20.34~27.12 ft.lb(15~20 N.m)
Φ 3/8 in (9.52 mm)	40.68~54.24 ft.lb(30~40 N.m)
Φ 1/2 in (12 mm)	61.02~74.58 ft.lb(45~55 N.m)
Φ 5/8 in (16 mm)	81.36~88.14 ft.lb(60~65 N.m)
Φ 3/4 in (19 mm)	94.93~101.7 ft.lb(70~75 N.m)

Step five: connect outdoor electric wire

1. Remove the wire clip; connect the power connection wire and signal control wire (only for heating unit) to the wiring terminal according to the color; fix them with screws.

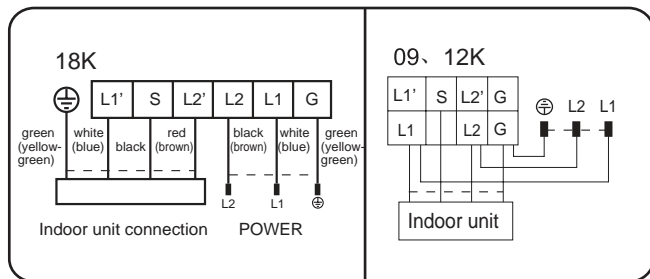
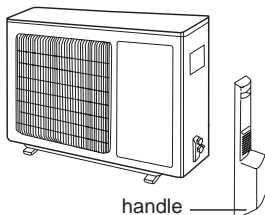

OUTDOOR UNIT INSTALLATION FOR SINGLE ZONE APPLICATIONS (REFER TO THE 38GJ OWNER'S MANUAL FOR MULTIZONE)

2. Fix the power connection wire and signal control wire with wire clip (only for cooling and heating unit).

Note:

- After tightening the screw, pull the power cord slightly to check if it is firm.
- Never cut the power connection wire to prolong or shorten the distance.

Step six: neaten the pipes

1. The pipes should be placed along the wall, bent reasonably and hidden possibly. Min. semidiameter of bending the pipe is 10cm.
2. If the outdoor unit is higher than the wall hole, you must set a U-shaped curve in the pipe before pipe goes into the room, in order to prevent rain from getting into the room.

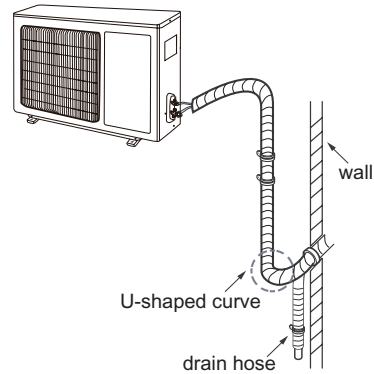

Note:

- The through-wall height of drain hose shouldn't be higher than the outlet pipe hole of indoor unit.
- Slant the drain hose slightly downwards. The drain hose can't be curved, raised and fluctuant, etc.

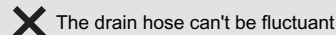
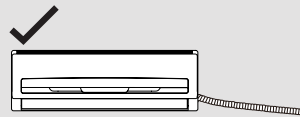
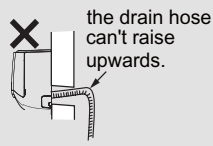
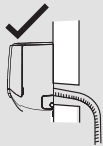

- The water outlet can't be placed in water in order to drain smoothly.

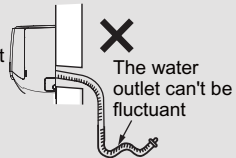
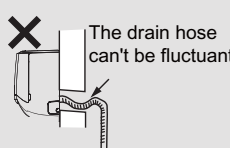
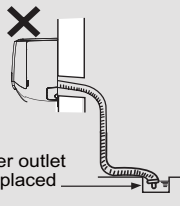

Vacuum pumping

Use vacuum pump

1. Remove the valve caps on the liquid valve and gas valve and the nut of refrigerant charging vent.
2. Connect the charging hose of piezometer to the refrigerant charging vent of gas valve and then connect the other charging hose to the vacuum pump.
3. Open the piezometer completely and operate for 10-15min to check if the pressure of piezometer remains in -14.5 PSI (-0.1 MPa).
4. Close the vacuum pump and maintain this status for 1-2min to check if the pressure of piezometer remains in -14.5 PSI (-0.1 MPa). If the pressure decreases, there may be leakage.
5. Remove the piezometer, open the valve core of liquid valve and gas valve completely with inner hexagon spanner.
6. Tighten the screw caps of valves and refrigerant charging vent.
7. Reinstall the handle.

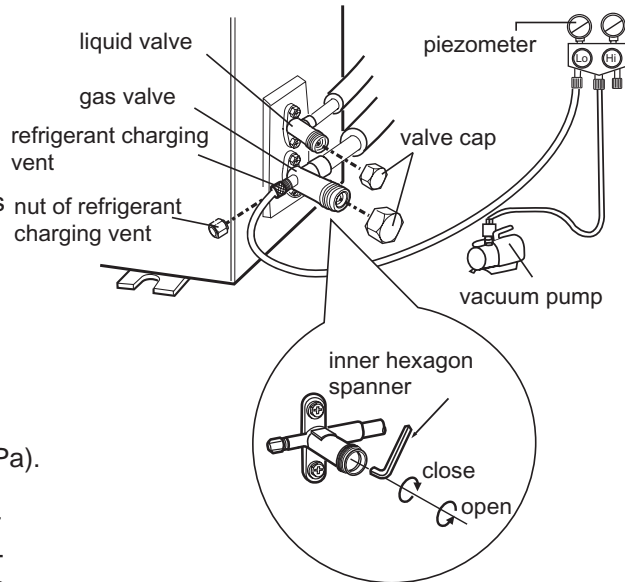

Leakage detection

1. With leakage detector:
Check if there is leakage with leakage detector.
2. With soap water:
If leakage detector is not available, please use soap water for leakage detection. Apply soap water at the suspected position and keep the soap water for more than 3min. If there are air bubbles coming out of this position, there's a leakage.

Checking installation

Check according to the following requirement after finishing installation.

Items to be checked	Possible problem
Has the unit been installed firmly?	The unit may drop, shake or emit noise.
Has the refrigerant leakage been tested?	It may cause insufficient cooling (heating) capacity.
Is heat insulation of pipeline sufficient?	It may cause condensation and water dripping.
Is water drained well?	It may cause condensation and water dripping.
Is the voltage of power supply according to the voltage marked on the nameplate?	It may cause malfunction or damaging the parts.
Is electric wiring and pipeline installed correctly?	It may cause malfunction or damaging the parts.
Is the unit grounded securely?	It may cause electric leakage.
Does the power cord follow the specification?	It may cause malfunction or damaging the parts.
Is there any obstruction in the air inlet and outlet?	It may cause insufficient cooling (heating) capacity.
The dust and sundries caused during installation are removed?	It may cause malfunction or damaging the parts.
The gas valve and liquid valve of connection pipe are open completely?	It may cause insufficient cooling (heating) capacity.

Testing unit operation

1. Preparation of test operation

- The client approves the air conditioner.
- Specify the important notes for air conditioner to the client.

2. Method of test operation

- Put through the power, press ON/OFF button on the remote controller to start operation.
- Press MODE button to select AUTO, COOL, DRY, FAN and HEAT to check whether the operation is normal or not.
- If the ambient temperature is lower than 60.8°F (16°C), the air conditioner can't start cooling.

Configuring connection pipe

1. Standard length of connection pipe
 - 16.4 ft (5 m), 24.6 ft (7.5 m), 26.2 ft (8 m)
2. Min. length of connection pipe is 9.8 ft (3 m).
3. Max. length of connection pipe and max. high difference.

Cooling capacity	Max length of connection pipe	Max height difference	Cooling capacity	Max length of connection pipe	Max height difference
5000Btu/h (1465W)	49.2 ft (15 m)	16.4 ft (5 m)	24000Btu/h (7032W)	82 ft (25 m)	32.8 ft (10 m)
7000Btu/h (2051W)	49.2 ft (15 m)	16.4 ft (5 m)	28000Btu/h (8204W)	98.4 ft (30 m)	32.8 ft (10 m)
9000Btu/h (2637W)	49.2 ft (15 m)	16.4 ft (5 m)	36000Btu/h (10548W)	98.4 ft (30 m)	65.6 ft (20 m)
12000Btu/h (3516W)	65.6 ft (20 m)	32.8 ft (10 m)	42000Btu/h (12306W)	98.4 ft (30 m)	65.6 ft (20 m)
18000Btu/h (5274W)	82 ft (25 m)	32.8 ft (10 m)	48000Btu/h (14064W)	98.4 ft (30 m)	65.6 ft (20 m)

4. The additional refrigerant oil and refrigerant charging required after prolonging connection pipe
 - After the length of connection pipe is prolonged for 32.8 ft (10m) at the basis of standard length, you should add 1/3 in³ (5 ml) of refrigerant oil for each additional 16.4 ft (5 m) of connection pipe.
 - The calculation method of additional refrigerant charging amount (on the basis of liquid pipe):
 - Additional refrigerant charging amount = prolonged length of liquid pipe × additional refrigerant charging amount per meter
 - When the length of connection pipe is above 16.4 ft (5 m), add refrigerant according to the prolonged length of liquid pipe. The additional refrigerant charging amount per meter is different according to the diameter of liquid pipe. See the following sheet.

Configuring connection pipe

Additional refrigerant charging amount for R410A

Diameter of connection pipe		Outdoor unit throttle	
Liquid pipe(in/mm)	Gas pipe(in/mm)	Cooling only(oz/ft (g/m))	Cooling and heating(oz/ft (g/m))
Φ 1/4 in (6 mm)	Φ3/8 in (9.52 mm) or Φ1/2 in (12 mm)	0.2 oz/ft (15 g/m)	0.2 oz/ft (20 g/m)
Φ 1/4 in (6 mm) or Φ3/8 in (9.52 mm)	Φ5/8 in (16 mm) or Φ3/4 in (19 mm)	0.2 oz/ft (15 g/m)	0.5 oz/ft (50 g/m)
Φ 1/2 in (12 mm)	Φ3/4 in (19 mm) or Φ7/8 in (22.2 mm)	0.3 oz/ft (30 g/m)	1.3 oz/ft (120 g/m)
Φ5/8 in (16 mm)	Φ1 in (25.4 mm) or Φ1 1/4 in (31.8mm)	0.6 oz/ft (60 g/m)	1.3 oz/ft (120 g/m)
Φ3/4 in (19 mm)	—	2.7 oz/ft (250 g/m)	2.7 oz/ft (250 g/m)
Φ7/8 in (22.2 mm)	—	3.8 oz/ft (350 g/m)	3.8 oz/ft (350 g/m)

Pipe expanding method

Note:

Improper pipe expanding is the main cause of refrigerant leakage. Please expand the pipe according to the following steps:

A: Cut the pipe

- Confirm the pipe length according to the distance of indoor unit and outdoor unit.
- Cut the required pipe with pipe cutter.

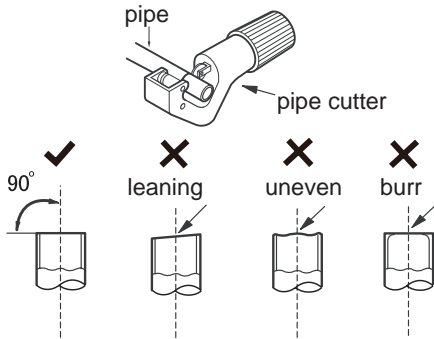

B: Remove the burrs

- Remove the burrs with shaper and prevent the burrs from getting into the pipe.

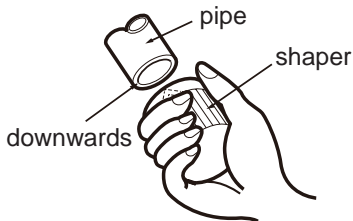

C: Put on suitable insulating pipe

D: Put on the union nut

- Remove the union nut on the indoor connection pipe and outdoor valve; install the union nut on the pipe.

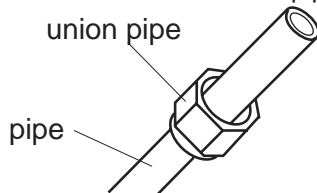

E: Expand the port

- Expand the port with expander.

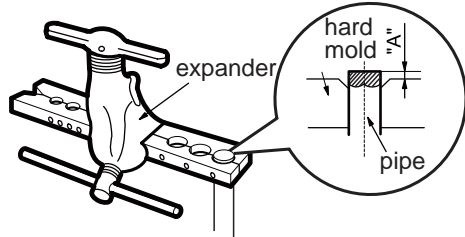

Note:

- "A" is different according to the diameter, please refer to the sheet below:

Outer diameter (mm (in))	A(in/mm)	
	Max	Min
Φ6-6.35(1/4")	1/20 in (1.3 mm)	0.02 in (0.7 mm)
Φ9.52(3/8")	3/50 in (1.6 mm)	1/24 in (1 mm)
Φ12-12.7(1/2")	0.07 in (1.8 mm)	1/24 in (1 mm)
Φ15.8-16(5/8")	1/10 in (2.4 mm)	2/25 in (2.2 mm)

F: Inspection

- Check the quality of expanding port. If there is any blemish, expand the port again according to the steps above.

smooth surface

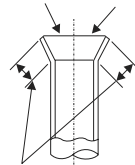

improper expanding

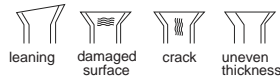

the length is equal



66129916984

Free Manuals Download Website

<http://myh66.com>

<http://usermanuals.us>

<http://www.somanuals.com>

<http://www.4manuals.cc>

<http://www.manual-lib.com>

<http://www.404manual.com>

<http://www.luxmanual.com>

<http://aubethermostatmanual.com>

Golf course search by state

<http://golfingnear.com>

Email search by domain

<http://emailbydomain.com>

Auto manuals search

<http://auto.somanuals.com>

TV manuals search

<http://tv.somanuals.com>