

Advanced User's Guide

MFC-J3520
MFC-J3720
MFC-J6520DW
MFC-J6720DW

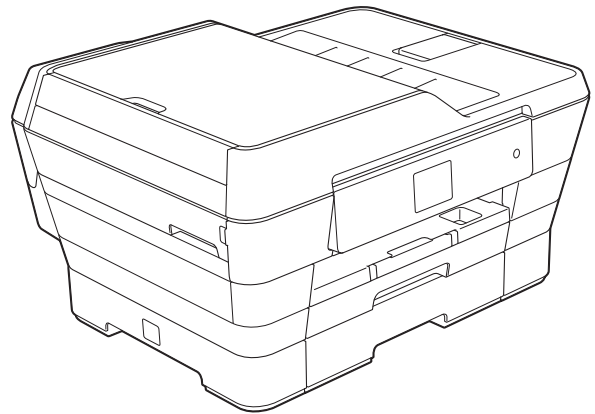

User's Guides and where do I find them?

Which Guide?	What's in it?	Where is it?
Product Safety Guide	Read this Guide first. Please read the Safety Instructions before you set up your machine. See this Guide for trademarks and legal limitations.	Printed / In the box
Quick Setup Guide	Follow the instructions for setting up your machine, and installing the drivers and software for the operating system and connection type you are using.	Printed / In the box
Basic User's Guide	Learn the basic Fax, Copy, Scan and PhotoCapture Center™ operations and how to replace consumables. See troubleshooting tips.	Printed / In the box
Advanced User's Guide	Learn more advanced operations: Fax, Copy, security features, printing reports and performing routine maintenance.	PDF file / CD-ROM
Software and Network User's Guide	This Guide provides instructions for Scanning, Printing, PC-Fax and other operations that can be performed by connecting your Brother machine to a computer. You can also find useful information about using the Brother ControlCenter utility, using your machine in a network environment, and frequently used terms.	HTML file / CD-ROM
Web Connect Guide	This Guide provides useful information about accessing Internet services from the Brother machine, as well as downloading images, printing data and uploading files directly to Internet services.	PDF file / Brother Solutions Center ¹
AirPrint Guide	This Guide provides information for using AirPrint to print from OS X v10.7.x, 10.8.x and your iPhone, iPod touch, iPad, or other iOS device to your Brother machine without installing a printer driver.	PDF file / Brother Solutions Center ¹
Google Cloud Print Guide	This Guide provides details on how to use Google Cloud Print™ services for printing over the Internet.	PDF file / Brother Solutions Center ¹
Wi-Fi Direct™ Guide	This Guide provides details on how to configure and use your Brother machine for wireless printing directly from a mobile device supporting the Wi-Fi Direct™ standard.	PDF file / Brother Solutions Center ¹
Mobile Print/Scan Guide for Brother iPrint&Scan	This Guide provides useful information about printing from your mobile device and scanning from your Brother machine to your mobile device when connected to a Wi-Fi network.	PDF file / Brother Solutions Center ¹

¹ Visit us at <http://solutions.brother.com/>.

Table of Contents

1	General setup	1
	IMPORTANT NOTE.....	1
	Memory Storage	1
	Setting Daylight Saving Time (Not available in South Africa)	1
	Automatic Daylight Saving Time (For South Africa only).....	2
	Sleep Mode	2
	Touchscreen LCD.....	3
	Changing the Touchscreen language (depending on your model).....	3
	Setting the Dim Timer for the backlight	3
	Dial Prefix (Not available in South Africa).....	4
	Setting up or changing the prefix number.....	4
2	Security features	5
	Secure Function Lock 2.0.....	5
	Before you begin to use Secure Function Lock 2.0.....	5
	Setting and changing the Administrator Password.....	6
	Setting up restricted users.....	6
	Turning Secure Function Lock on/off.....	7
	Switching users	8
	Changing to the Public mode	8
	Restricting dialling.....	8
	Dial pad restriction.....	8
	Address Book restriction.....	9
	Shortcut restriction.....	9
	LDAP Server restriction	9
3	Sending a fax	10
	Additional sending options.....	10
	Sending faxes using multiple settings	10
	Stop faxing.....	10
	Contrast.....	11
	Changing fax resolution.....	11
	Setting your changes as a new default.....	12
	Restoring fax options to the factory default	13
	Saving fax options as a Shortcut.....	13
	Additional sending operations.....	14
	Sending a fax manually	14
	Sending a fax at the end of a conversation	14
	Dual Access (Monochrome only).....	14
	Broadcasting (Monochrome only).....	15
	Real Time Transmission.....	17
	Overseas Mode	17
	Delayed Faxing (Monochrome only).....	18
	Delayed Batch Transmission (Monochrome only).....	18
	Checking and cancelling waiting jobs.....	19
	Polling.....	19
	Polled Transmit (Monochrome only).....	19

4 Receiving a fax 21

Memory Receive (Monochrome only).....	21
Fax Forwarding.....	21
Fax Storage.....	21
Printing a fax from the memory.....	22
Turning off Memory Receive operations.....	22
Changing Memory Receive operations.....	23
Remote Retrieval.....	24
Setting a Remote Access Code.....	24
Using your Remote Access Code.....	24
Remote Fax commands.....	25
Retrieving fax messages.....	26
Changing your Fax Forwarding number.....	26
Additional receiving operations.....	27
Out of Paper Reception.....	27
Printing a reduced incoming fax.....	27
Receiving a fax at the end of a conversation.....	27
Polling.....	28
Polling Receive.....	28

5 Dialling and storing numbers 31

Additional dialling operations.....	31
Combining Address Book numbers.....	31
Additional ways to store numbers.....	32
Storing Address Book numbers from the Outgoing Call history.....	32
Storing Address Book numbers from the Caller ID history (Only available for some countries).....	32
Setting up Groups for Broadcasting.....	33

6 Printing reports 35

Fax reports.....	35
Transmission Verification Report.....	35
Fax Journal (activity report).....	35
Reports.....	36
How to print a report.....	36

7 Making copies 37

Copy options.....	37
Stop copying.....	37
Improving copy speed and quality.....	37
Enlarging or reducing copies.....	38
Making N in 1 copies or a poster (Page Layout).....	39
2 in 1 ID copy (Page Layout).....	42
Sorting copies.....	43
Adjusting Density.....	43
Ink Save Mode.....	44
Thin Paper Copy.....	45
Auto Deskew.....	45
Book Copy.....	46
Watermark Copy.....	46
Remove Background Colour.....	47
2-sided copying.....	48
Setting your changes as a new default.....	49
Restoring all settings to the factory default.....	50
Saving copy options as a Shortcut.....	50
A3 Copy Shortcuts.....	51
A3 Copy Shortcut.....	51

8 Printing photos from a memory card or USB Flash drive 53

PhotoCapture Center™ operations.....	53
Memory cards, USB Flash drives and folder structures.....	53
Movie printing.....	54
Print Images.....	54
Print Index (Thumbnails).....	54
Printing Photos.....	55
Enhance Photos.....	55
ID Photo Print.....	57
Slide Show.....	58
DPOF printing.....	59
PhotoCapture Center™ print settings.....	59
Print Quality.....	59
Paper options.....	60
Auto Correct.....	61
Adjusting Brightness, Contrast and Colour.....	62
Cropping.....	64
Borderless printing.....	64
Date Print.....	65
Setting your changes as a new default.....	65
Restoring all settings to the factory default.....	66
Scan to a memory card or USB Flash drive.....	66
Auto Crop.....	66
How to set a new default.....	68
How to reset to the factory default.....	68
Saving scan options as a Shortcut.....	69

9	Printing photos from a camera	70
	Printing photos directly from a PictBridge camera	70
	PictBridge requirements	70
	Setting your digital camera	70
	Printing Images.....	71
	DPOF printing.....	72
	Printing photos directly from a digital camera (without PictBridge).....	72
	Printing Images.....	73
A	Routine maintenance	74
	Cleaning and checking the machine	74
	Cleaning the outside of the machine	74
	Cleaning the machine's printer platen	75
	Cleaning the paper feed rollers	76
	Cleaning the paper pick-up rollers.....	77
	Cleaning the paper pick-up rollers for paper tray #2 (MFC-J3720/MFC-J6720DW).....	78
	Checking the ink volume	79
	Packing and shipping the machine	79
B	Glossary	82
C	Index	86

IMPORTANT NOTE

- Most of the illustrations in this User's Guide show the MFC-J6720DW.

Memory Storage

Your menu settings are stored permanently, and in the event of a power failure, will not be lost. Temporary settings (for example, *Overseas Mode*) will be lost. If you have chosen *Set New Default* for your preferred *Fax, Scan, Copy and Photo* settings, those settings will not be lost. Also, during a power failure, the machine will retain the date and time and programmed fax timer jobs (for example, *Delayed Fax*) for up to 24 hours.



Setting Daylight Saving Time (Not available in South Africa)

You can set the machine to change for daylight saving time. When selecting *Forward Hour* it will forward the time by an hour and backward one hour when selecting *Backward Hour*. Make sure you have set the correct date and time in the *Date & Time* setting.

- 1 Press  (Settings).
- 2 Press All Settings.
- 3 Press ▲ or ▼ to display Initial Setup.
- 4 Press Initial Setup.
- 5 Press ▲ or ▼ to display Date & Time.
- 6 Press Date & Time.
- 7 Press ▲ or ▼ to display Daylight Save.
- 8 Press Daylight Save.
- 9 Press Forward Hour or Backward Hour.
- 10 Press .



Automatic Daylight Saving Time (For South Africa only)

You can set the machine to change automatically for daylight saving time. It will reset itself forward one hour in the spring and backward one hour in the autumn. Make sure you have set the correct date and time in the **Date & Time** setting.

- 1 Press  (Settings).
- 2 Press All Settings.
- 3 Press ▲ or ▼ to display Initial Setup.
- 4 Press Initial Setup.
- 5 Press ▲ or ▼ to display Date & Time.
- 6 Press Date & Time.
- 7 Press ▲ or ▼ to display Auto Daylight.
- 8 Press Auto Daylight.
- 9 Press Off (or On).
- 10 Press .

Sleep Mode



You can choose how long the machine will remain idle before it goes into Sleep Mode (up to 60 minutes). The timer will restart if any operation is carried out on the machine.

- 1 Press  (Settings).
- 2 Press All Settings.
- 3 Press ▲ or ▼ to display General Setup.
- 4 Press General Setup.
- 5 Press ▲ or ▼ to display Sleep Mode.
- 6 Press Sleep Mode.
- 7 Press ▲ or ▼ to display 1Min, 2Mins, 3Mins, 5Mins, 10Mins, 30Mins or 60Mins. Press the option you want to set.
- 8 Press .

Touchscreen LCD



Changing the Touchscreen language (depending on your model)

You can change the Touchscreen language.

- 1 Press  (Settings).
- 2 Press All Settings.
- 3 Press ▲ or ▼ to display Initial Setup.
- 4 Press Initial Setup.
- 5 Press ▲ or ▼ to display Local Language.
- 6 Press Local Language.
- 7 Press your language.
- 8 Press .

Setting the Dim Timer for the backlight

You can set how long the Touchscreen LCD backlight stays on after the last finger press.

- 1 Press  (Settings).
- 2 Press All Settings.
- 3 Press ▲ or ▼ to display General Setup.
- 4 Press General Setup.
- 5 Press ▲ or ▼ to display LCD Settings.
- 6 Press LCD Settings.
- 7 Press Dim Timer.
- 8 Press ▲ or ▼ to display 10Secs, 20Secs, 30Secs or Off, and then press the option you want.
- 9 Press .

Dial Prefix (Not available in South Africa)

11 Press .

The Dial Prefix setting will automatically dial a predefined number before every fax number you dial. For example, if your telephone system requires a “9” to dial an outside number, use this setting to automatically dial 9 for every fax you send.

Setting up or changing the prefix number

- 1 Press  (Settings).
- 2 Press All Settings.
- 3 Press ▲ or ▼ to display Initial Setup.
- 4 Press Initial Setup.
- 5 Press ▲ or ▼ to display Dial Prefix.
- 6 Press Dial Prefix.
- 7 Press On (or Off).
- 8 Press Dial Prefix.
- 9 Enter the prefix number (up to 5 digits) using the keyboard on the Touchscreen.
- 10 Press OK.

NOTE

- If your telephone system requires a timed break recall (hookflash), press ! on the Touchscreen.
 - You cannot use ! with any other numbers or characters.
 - (Not available in New Zealand) If the pulse dialling mode is on, # and * are not available to use.
-

Secure Function Lock 2.0

Secure Function Lock lets you restrict public access to certain machine functions:

- Fax Send
- Fax Receive
- Copy
- Scan
- Print from Media
- Scan to Media
- PC Print
- Colour Print
- Page Limit
- Web Upload
- Web Download

This feature also prevents users from changing the default settings of the machine by limiting access to the menu settings.

Before using the security features, you must first enter an administrator password.

Access to restricted operations can be enabled by creating a restricted user. Restricted users must enter a password to use the machine.

Make a careful note of your password. If you forget it, please contact Brother customer service for support.

NOTE

- Only administrators can set limitations and make changes for each user.
- If Fax Tx is disabled, you cannot use any functions in the Fax menu.
- Polled Transmit and Polling Receive are enabled only when both Fax Tx and Fax Rx are enabled.
- You cannot edit or delete a Shortcut when Secure Function Lock is set to On.

Before you begin to use Secure Function Lock 2.0

You can configure Secure Function Lock 2.0 settings using a Web browser. Before configuration, the following preparations are required:

- 1 Start your Web browser.
- 2 Type "http://machine's IP address/" into your browser's address bar (where "machine's IP address" is the IP address of the Brother machine).

- For example:

http://192.168.1.2/

NOTE

You can find the machine's IP address in the Network Configuration List.

(See Software and Network User's Guide.)

- 3 Enter a password in the **Login** box. (This is a password to log into the machine's Web page, not the administrator password for Secure Function Lock.) Click .

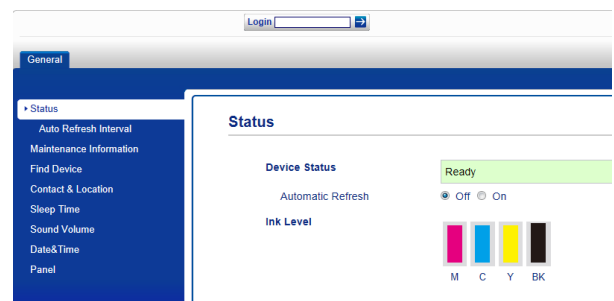

NOTE

If you are using a Web browser to configure the machine's settings for the first time, set a password.

- 1 Click **Please configure the password.**
- 2 Enter a password you want to use (up to 32 characters).
- 3 Re-enter the password in the **Confirm New Password** box.
- 4 Click **Submit.**

Setting and changing the Administrator Password

You can configure these settings using a Web browser. To set up the Web page, see *Before you begin to use Secure Function Lock 2.0* on page 5. Then follow the instructions below.

Setting the administrator password

The password you set in these steps is for the administrator. This password is used to set up users and to turn Secure Function Lock on or off. (See *Setting up restricted users* on page 6 and *Turning Secure Function Lock on/off* on page 7.)

- 1 Click **Administrator.**
- 2 Click **Secure Function Lock.**
- 3 Enter a four-digit number for the password in the **New Password** box.



- 4 Re-enter the password in the **Retype Password** box.
- 5 Click **Submit.**

Changing the administrator password

- 1 Click **Administrator.**
- 2 Click **Secure Function Lock.**
- 3 Enter a four-digit number for the new password in the **New Password** box.
- 4 Re-enter the new password in the **Retype Password** box.
- 5 Click **Submit.**

Setting up restricted users

You can set up users with restrictions and a password. You can set up to 10 users.

You can configure these settings using a Web browser.

To set up the Web page, see *Before you begin to use Secure Function Lock 2.0* on page 5. Then follow the instructions below:

- 1 Click **Administrator.**
- 2 Click **Secure Function Lock.**
- 3 Enter an alphanumeric Group name or User name (up to 15 characters) in the **ID Number/Name** box and then enter a four-digit password in the **PIN** box.



- 4 Uncheck the functions that you want to restrict in the **Function Restrictions** boxes. If you want to configure the maximum page count, check the **On** box in **Print Limits**, and then enter the number in the **Max. Pages** box. Then click **Submit**.

NOTE

- You cannot use the same password as another user's password.
 - You can set up one Public user. Public users do not need to enter a password.
- For more information, see *Software and Network User's Guide*.

Turning Secure Function Lock on/off

NOTE

If you enter the wrong password, the Touchscreen will show `Wrong Password`. Enter the correct password. If you forget it, please contact Brother customer service for support.

Turning Secure Function Lock on

- 1 Press  (Settings).
- 2 Press `All Settings`.
- 3 Press **▲** or **▼** to display `General Setup`.
- 4 Press `General Setup`.
- 5 Press **▲** or **▼** to display `Function Lock`.
- 6 Press `Function Lock`.
- 7 Press `Lock Off→On`.

- 8 Enter your four-digit administrator password using the keyboard on the Touchscreen.
Press **OK**.

NOTE

The Secure Function Lock icon is prominently displayed in the Home screen.



Turning Secure Function Lock off

- 1 Press .
- 2 Press `Lock On→Off`.
- 3 Enter your four-digit administrator password using the keyboard on the Touchscreen.
Press **OK**.

Switching users

This setting allows a restricted user to log on to the machine when the Secure Function Lock is turned on.

- 1 On the Touchscreen, press .
- 2 Press `Change User`.
- 3 Press `▲` or `▼` to display your user name.
- 4 Press your user name.
- 5 Enter your four-digit user password using the keyboard on the Touchscreen. Press `OK`.

Changing to the Public mode

- 1 Press .
- 2 Press `Go to Public`.

Restricting dialling

This feature prevents users from sending a fax or call to a wrong number by mistake. You can set the machine to restrict dialling when you use the dial pad, Address Book, Shortcut and LDAP search.

If you choose `Off`, the machine does not restrict the dialling method.

If you choose `Enter # Twice`, the machine will prompt you to re-enter the number, and will start dialling after you re-enter the number correctly. If you re-enter the wrong number, the Touchscreen will show `Try again`. Press `Close` and enter the number twice again.

If you choose `On`, the machine will restrict all fax sending and outbound calls for that dialling method.

NOTE



- The `Enter # Twice` setting will not work if you lift an external handset before entering the number. You will not be asked to re-enter the number.
- If you chose `On` or `Enter # Twice`, you cannot use the Broadcasting feature.

Dial pad restriction

- 1 Press  (`Settings`).
- 2 Press `All Settings`.
- 3 Press `▲` or `▼` to display `Fax`.
- 4 Press `Fax`.
- 5 Press `▲` or `▼` to display `Dial Restriction`.
- 6 Press `Dial Restriction`.
- 7 Press `▲` or `▼` to display `Dial Pad`.
- 8 Press `Dial Pad`.

- 9 Press **Enter # Twice, On or Off**.
- 10 Press .



Address Book restriction

- 1 Press  (Settings).
- 2 Press **All Settings**.
- 3 Press **▲ or ▼ to display Fax**.
- 4 Press **Fax**.
- 5 Press **▲ or ▼ to display Dial Restriction**.
- 6 Press **Dial Restriction**.
- 7 Press **▲ or ▼ to display Address Book**.
- 8 Press **Address Book**.
- 9 Press **Enter # Twice, On or Off**.
- 10 Press .



NOTE

If you combine Address Book numbers when dialling, the address will be recognized as dial pad input and will not be restricted.

Shortcut restriction

- 1 Press  (Settings).
- 2 Press **All Settings**.
- 3 Press **▲ or ▼ to display Fax**.
- 4 Press **Fax**.
- 5 Press **▲ or ▼ to display Dial Restriction**.
- 6 Press **Dial Restriction**.
- 7 Press **▲ or ▼ to display Shortcuts**.
- 8 Press **Shortcuts**.
- 9 Press **Enter # Twice, On or Off**.
- 10 Press .

LDAP Server restriction

- 1 Press  (Settings).
- 2 Press **All Settings**.
- 3 Press **▲ or ▼ to display Fax**.
- 4 Press **Fax**.
- 5 Press **▲ or ▼ to display Dial Restriction**.
- 6 Press **Dial Restriction**.
- 7 Press **▲ or ▼ to display LDAP Server**.
- 8 Press **LDAP Server**.
- 9 Press **Enter # Twice, On or Off**.
- 10 Press .

3

Sending a fax



Additional sending options

Sending faxes using multiple settings

When you send a fax, you can choose a combination of settings, such as Fax Resolution, Contrast, Glass Scan Size, and Real Time TX.

You can also choose Call History, Address Book, Broadcasting, Preview, Colour Setting, Delayed Fax, Batch TX, Polled TX, Polling RX, Overseas Mode, Set New Default, and Factory Reset.

Some settings are only available when sending mono faxes.

- 1 Load your document.
- 2 Do one of the following:
 - When Fax Preview is set to Off, press  (Fax).
 - When Fax Preview is set to On, press  (Fax) and then  (Sending Faxes).

The Touchscreen shows:

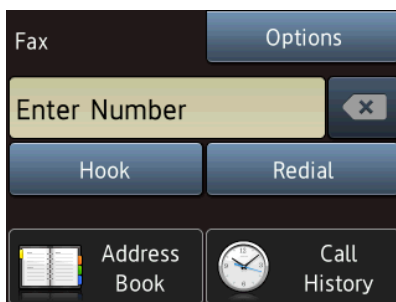

- 3 Press Options.

- 4 Press ▲ or ▼ to display the setting you want to change. When the setting is displayed, press it.
- 5 Press the option you want to set.
- 6 Go back to step 4 to change additional settings.
- 7 Press OK when you have finished changing settings.
- 8 Enter the fax number.
- 9 Press Fax Start.

NOTE

- Most settings are temporary, and the machine returns to its default settings after you send a fax.
- You can save some of the settings you use most often by making them the default settings. These settings will remain until you change them again. (See *Setting your changes as a new default* on page 12.)
- You can also save some of the settings you use most often by setting them as a Shortcut. (See *Saving fax options as a Shortcut* on page 13.)



Stop faxing

To stop faxing, press .

Contrast

If your document is very light or very dark, you may want to change the contrast. For most documents, the factory setting **Auto** can be used. **Auto** chooses the suitable contrast for your document.

Choose **Light** when sending a light document. Choose **Dark** when sending a dark document.

- 1 Load your document.
- 2 Do one of the following:
 - When Fax Preview is set to **Off**, press  (**Fax**).
 - When Fax Preview is set to **On**, press  (**Fax**) and then  (**Sending Faxes**).
- 3 Press **Options**.
- 4 Press **▲** or **▼** to display **Contrast**.
- 5 Press **Contrast**.
- 6 Press **Auto**, **Light** or **Dark**.
- 7 Press **OK**.
- 8 Enter the fax number.
- 9 Press **Fax Start**.



NOTE

Even if you choose **Light** or **Dark**, the machine will send the fax using the **Auto** setting in the following conditions:

- When you send a colour fax.
- When you choose **Photo** as the Fax Resolution.

Changing fax resolution

The quality of a fax can be improved by changing the fax resolution.

- 1 Load your document.
- 2 Do one of the following:
 - When Fax Preview is set to **Off**, press  (**Fax**).
 - When Fax Preview is set to **On**, press  (**Fax**) and then  (**Sending Faxes**).
- 3 Press **Options**.
- 4 Press **▲** or **▼** to display **Fax Resolution**.
- 5 Press **Fax Resolution**.
- 6 Press **▲** or **▼** to display **Standard**, **Fine**, **S.Fine** or **Photo**, and then press the option you want.
- 7 Press **OK**.
- 8 Enter the fax number.
- 9 Press **Fax Start**.

NOTE

You can choose four different resolution settings for monochrome faxes, and two for colour.



Monochrome	
Standard	Suitable for most typed documents.
Fine	Good for small print and transmits a little slower than Standard resolution.
S.Fine	Good for small print or artwork and transmits slower than Fine resolution.
Photo	Use when the document has varying shades of grey or is a photograph. Photo has the slowest transmission.

Colour	
Standard	Suitable for most typed documents.
Fine	Use when the document is a photograph. The transmission time is slower than Standard resolution.

If you choose S.Fine or Photo and then send a colour fax (choosing Colour in Colour Setting), the machine will send the fax using the Fine setting.

Setting your changes as a new default





You can save the settings for the fax options you use most often by setting them as the default settings, such as Fax Resolution, Contrast, Glass Scan Size, Preview, Real Time TX and Colour Setting. These settings will remain until you change them again.

- 1 Do one of the following:
 - When Fax Preview is set to Off, press  (Fax).
 - When Fax Preview is set to On, press  (Fax) and then  (Sending Faxes).
- 2 Press Options.
- 3 Press ▲ or ▼ to choose the menu option that you want to change. Press your new option.

Repeat this step for each setting you want to change.
- 4 After changing the last setting to your preferred option, press ▲ or ▼ to display Set New Default.
- 5 Press Set New Default.
- 6 The Touchscreen asks you to confirm the change to the new default settings. Press Yes to confirm.
- 7 Press .



Restoring fax options to the factory default

You can restore all the fax options you have changed back to the factory default. These settings will remain until you change them again.

- 1 Do one of the following:
 - When Fax Preview is set to *Off*, press  (Fax).
 - When Fax Preview is set to *On*, press  (Fax) and then  (Sending Faxes).
- 2 Press *Options*.
- 3 Press **▲** or **▼** to display *Factory Reset*.
- 4 Press *Factory Reset*.
- 5 The Touchscreen asks you to confirm to change back to the factory default. Press *Yes* to confirm.
- 6 Press .

Saving fax options as a Shortcut

You can store all the new fax options you use frequently by saving them as a Shortcut.

- 1 Do one of the following:
 - When Fax Preview is set to *Off*, press  (Fax).
 - When Fax Preview is set to *On*, press  (Fax) and then  (Sending Faxes).

- 2 Enter the fax number.

NOTE

If the Shortcut is to be used for broadcasting, press *Options* and choose *Broadcasting* in step 4 before entering the fax number in step 2.

(See *Broadcasting (Monochrome only)* on page 15.)

- 3 Press *Options*.
- 4 Press **▲** or **▼** to display *Fax Resolution*, *Contrast*, *Glass Scan Size*, *Preview*, *Colour Setting*, *Real Time TX* or *Overseas Mode*, and then press the setting you want to change. Then press the new option you want to set. Repeat this step for each setting you want to change.
- 5 When you have finished choosing new options, press *OK*.
- 6 Press *Save as Shortcut*.
- 7 Confirm the displayed list of options you have chosen for the Shortcut, and then press *OK*.
- 8 Enter a name for the Shortcut using the keyboard on the Touchscreen. (For help entering letters, see *Basic User's Guide: Entering Text*.) Press *OK*.
- 9 Press *OK* to save your Shortcut.

Additional sending operations



Sending a fax manually

Manual transmission lets you hear the dialling, ringing and fax-receiving tones while sending a fax.

NOTE

To send a multi-page fax, use the ADF.

(Not available in South Africa)

- 1 Load your document.
- 2 Do one of the following:
 - When Fax Preview is set to *Off*, press  (Fax).
 - When Fax Preview is set to *On*, press  (Fax) and then  (Sending Faxes).
- 3 To listen for a dial tone, press *Hook*.
- 4 Dial the fax number.
- 5 When you hear the fax tones, press *Fax Start*.
If you are using the scanner glass, press *Send* on the Touchscreen to send the fax.

(For South Africa only)

- 1 Load your document.
- 2 To listen for a dial tone, pick up the handset of the external telephone.
- 3 Dial the fax number using the external telephone.

- 4 When you hear the fax tones, press *Fax Start*.
If you are using the scanner glass, press *Send* on the Touchscreen to send the fax.
- 5 Replace the handset of the external phone.

Sending a fax at the end of a conversation

At the end of a conversation, you can send a fax to the other party before you both hang up.

- 1 Ask the other party to wait for the fax tones (beeps) and then to press the *Start* or *Send* key before hanging up.
- 2 Load your document.
- 3 Press *Fax Start*.
If you are using the scanner glass, press *Send* to send the fax.
- 4 Replace the handset of the external phone.

Dual Access (Monochrome only)

You can dial a number and start scanning the fax into memory—even when the machine is sending from memory, receiving faxes or printing PC data. The Touchscreen shows the new job number.

The number of pages you can scan into the memory will vary depending on the data that is printed on them.

NOTE

If the *Out of Memory* message appears, press  or *Quit* to cancel or *Send Now* to send the pages scanned so far.

Broadcasting (Monochrome only)

Broadcasting is automatically sending the same fax message to more than one fax number. You can include Groups, Address Book numbers, and up to 50 manually dialled numbers in the same broadcast.



After the broadcast is finished, a Broadcast Report will be printed.

Before you begin the broadcast

Address Book numbers must be stored in the machine's memory before they can be used in a broadcast. (See Basic User's Guide: *Storing Address Book numbers.*)

Group numbers must also be stored in the machine's memory before they can be used in a broadcast. Group numbers include many stored Address Book numbers for easier dialling. (See *Setting up Groups for Broadcasting* on page 33.)

How to broadcast a fax

- 1 Load your document.
- 2 Do one of the following:
 - When Fax Preview is set to Off, press  (Fax).
 - When Fax Preview is set to On, press  (Fax) and then  (Sending Faxes).
- 3 Press Options.
- 4 Press ▲ or ▼ to display Broadcasting.
- 5 Press Broadcasting.
- 6 Press Add Number.

- 7 You can add numbers to the broadcast in the following ways:

- Press Add Number and enter a number using the keyboard on the Touchscreen.
Press OK.

NOTE

If you downloaded Internet Fax:

If you want to broadcast using an E-mail address, press , enter the E-mail address, and press OK. (For help entering letters, see Basic User's Guide: *Entering Text.*)

- Press Add from Address book. Press ▲ or ▼ to display the number you want to add to the broadcast. Press the check boxes of the numbers you want to add to the broadcast. After you have checked all the numbers you want, press OK.
- Press Search in Address book. Enter the first letter of the name and press OK. Press the name, and then press the number you want to add to the broadcast.

- 8 After you have entered all the fax numbers by repeating steps 6 and 7, press OK.

- 9 Press **Fax Start**.

NOTE

Broadcasting is not available when you select **Colour** in **Colour Setting**.

Faxing from the ADF

- The machine starts scanning the document.

Faxing from the scanner glass

When the Touchscreen asks you **Next page?**, do one of the following:

- To send a single page, press **No**.
The machine starts sending the document.
- To send more than one page, press **Yes** and place the next page on the scanner glass.

Press **OK**.



The machine starts scanning the page. (Repeat this step for each page.)

After all the pages have been scanned, press **No** to start.

NOTE

- If you did not use up any of the numbers for **Groups**, you can “broadcast” faxes to as many as 250 different numbers.
- The machine’s available memory will vary depending on the types of jobs in the memory and the numbers used for broadcasting. If you broadcast to the maximum amount of numbers available, you will not be able to use dual access and delayed fax.
- If the **Out of Memory** message appears, press  or **Quit** to cancel or **Send Now** to send the pages scanned so far.



Cancelling a Broadcast in progress

- 1 Press .
- 2 Do one of the following:
 - To cancel the entire broadcast, press **Entire Broadcast**. Go to step 3.
 - To cancel the current job, press the name or number being dialled on the Touchscreen. Go to step 4.
 - To exit without cancelling, press .
- 3 When the Touchscreen asks if you want to cancel the entire broadcast, do one of the following:
 - Press **Yes** to confirm.
 - To exit without cancelling, press **No**.
- 4 Do one of the following:
 - To cancel the current job, press **Yes**.
 - To exit without cancelling, press **No**.

Real Time Transmission

When you are sending a fax, the machine will scan the documents into the memory before sending. Then, as soon as the telephone line is free, the machine will start dialling and sending.

Sometimes, you may want to send an important document immediately, without waiting for the machine to scan it into memory. You can do this by turning on Real Time TX.



- 1 Load your document.
- 2 Do one of the following:
 - When Fax Preview is set to Off, press  (Fax).
 - When Fax Preview is set to On, press  (Fax) and then  (Sending Faxes).
- 3 Press Options.
- 4 Press ▲ or ▼ to display Real Time TX.
- 5 Press Real Time TX.
- 6 Press On (or Off).
- 7 Press OK.
- 8 Enter the fax number.
- 9 Press Fax Start.

NOTE

- If you are sending a colour fax or if the memory is full and you are sending a monochrome fax from the ADF, the machine will send the document in real time (even if Real Time TX is set to Off).
- In Real Time Transmission, the automatic redial feature does not work when you are using the scanner glass.



Overseas Mode

If you are having difficulty sending a fax overseas due to possible interference on the telephone line, we recommend that you turn on Overseas Mode. After you send a fax using this feature, the feature will automatically turn itself off.

- 1 Load your document.
- 2 Do one of the following:
 - When Fax Preview is set to Off, press  (Fax).
 - When Fax Preview is set to On, press  (Fax) and then  (Sending Faxes).
- 3 Press Options.
- 4 Press ▲ or ▼ to display Overseas Mode.
- 5 Press Overseas Mode.
- 6 Press On (or Off).
- 7 Press OK.
- 8 Enter the fax number.
- 9 Press Fax Start.

Delayed Faxing (Monochrome only)

You can store up to 50 faxes in the memory to be sent within 24 hours. These faxes will be sent at the time of day you enter in step 9.

- 1 Load your document.
- 2 Do one of the following:
 - When Fax Preview is set to Off, press  (Fax).
 - When Fax Preview is set to On, press  (Fax) and then  (Sending Faxes).
- 3 Press Options.
- 4 Press ▲ or ▼ to display Delayed Fax.
- 5 Press Delayed Fax.
- 6 Press Delayed Fax.
- 7 Press On (or Off).
- 8 Press Set Time.
- 9 To enter the time you want the fax to be sent, do one of the following:
 - If you have set 12h Clock as the format in the Clock Type setting, enter the time (in 12-hour format) using the keyboard on the Touchscreen, and then press AM or PM. Press OK.
 - If you have set 24h Clock in the Clock Type setting, enter the time (in 24-hour format) using the keyboard on the Touchscreen. Press OK. (For example, enter 19:45 for 7:45 PM.)

NOTE

The number of pages you can scan into the memory depends on the amount of data that is printed on each page.





- 10 Press OK.
- 11 Enter the fax number.
- 12 Press Fax Start.

NOTE

Delayed Fax is not available when you select Colour in Colour Setting.



Delayed Batch Transmission (Monochrome only)

Before sending the delayed faxes, your machine will help you economize by sorting all the faxes in the memory by destination and scheduled time. All delayed faxes that are scheduled to be sent at the same time to the same fax number will be sent as one fax to save transmission time.

- 1 Do one of the following:
 - When Fax Preview is set to Off, press  (Fax).
 - When Fax Preview is set to On, press  (Fax) and then  (Sending Faxes).
- 2 Press Options.
- 3 Press ▲ or ▼ to display Batch TX.
- 4 Press Batch TX.
- 5 Press On (or Off).
- 6 Press .

Checking and cancelling waiting jobs

You can check which jobs are still waiting in the memory to be sent, or cancel a job. (If there are no jobs, the Touchscreen shows No Jobs Waiting.)

- 1 Press  (Settings).
- 2 Press All Settings.
- 3 Press ▲ or ▼ to display Fax.
- 4 Press Fax.
- 5 Press ▲ or ▼ to display Remaining Jobs.
- 6 Press Remaining Jobs. Any waiting jobs appear on the Touchscreen.
- 7 Press ▲ or ▼ to scroll through the jobs and press the job you want to cancel. Press OK.
- 8 Do one of the following:
 - To cancel, press Yes. If you want to cancel another job, go to step 7.
 - To exit without cancelling, press No.
- 9 When you have finished, press .

Polling



Polling lets you set up your machine so other people can receive faxes from you, but they pay for the call. It also lets you call somebody else's fax machine and receive a fax from it, so you pay for the call. The polling feature needs to be set up on both machines for this to work. Not all fax machines support polling.

Polled Transmit (Monochrome only)

Polled Transmit lets you set up your machine to wait with a document so another fax machine can call and retrieve it.

The document will be stored and can be retrieved by any other fax machine until you delete it from the memory. (See *Checking and cancelling waiting jobs* on page 19.)

Setting up Polled Transmit



- 1 Load your document.
- 2 Do one of the following:
 - When Fax Preview is set to Off, press  (Fax).
 - When Fax Preview is set to On, press  (Fax) and then  (Sending Faxes).
- 3 Press Options.
- 4 Press ▲ or ▼ to display Polled TX.
- 5 Press Polled TX.
- 6 Press Standard.
- 7 Press Fax Start.

- 8 If you are using the scanner glass, the Touchscreen will prompt you to choose one of the following options:
 - Press **Yes** to scan another page. Go to step 9.
 - Press **No** to store the document in the memory. Other fax machines can now call your machine and retrieve the document.
- 9 Place the next page on the scanner glass and press **OK**. Repeat steps 8 and 9 for each additional page. The document will be stored in the memory and will be sent when it is polled.

Setting up Secure Polled Transmit

Secure Polling lets you restrict who can get the documents you set up to be polled.

Secure Polling only works with Brother fax machines. If another person wants to retrieve a fax from your machine, they will have to enter the secure code.

- 1 Load your document.
- 2 Do one of the following:
 - When Fax Preview is set to **Off**, press  (Fax).
 - When Fax Preview is set to **On**, press  (Fax) and then  (Sending Faxes).
- 3 Press **Options**.
- 4 Press **▲** or **▼** to display **Polled TX**.
- 5 Press **Polled TX**.
- 6 Press **Secure**.
- 7 Enter a four-digit number. Press **OK**.

- 8 Press **Fax Start**.
- 9 If you are using the scanner glass, the Touchscreen will prompt you to choose one of the following options:
 - Press **Yes** to scan another page. Go to step 10.
 - Press **No** to store the document in the memory. Other fax machines can now call your machine and retrieve the document.
- 10 Place the next page on the scanner glass and press **OK**.
- 11 Repeat steps 9 and 10 for each additional page. The document will be stored in the memory and will be sent when it is polled.

Memory Receive (Monochrome only)

Memory Receive lets you receive faxes while you are away from the machine.

You can only use one Memory Receive operation at a time:

- Fax Forwarding
- Fax Storage
- PC-Fax Receive
- Off

You can change your selection at any time. If received faxes are still in the machine's memory when you change the Memory Receive operation, a message will appear on the Touchscreen. (See *Changing Memory Receive operations* on page 23.)

Fax Forwarding

When you choose **Fax Forward**, your machine stores the received fax in the memory. The machine will then dial the fax number you have programmed and forward the fax message.

- 1 Press  (Settings).
- 2 Press **All Settings**.
- 3 Press **▲** or **▼** to display **Fax**.
- 4 Press **Fax**.
- 5 Press **▲** or **▼** to display **Setup Receive**.
- 6 Press **Setup Receive**.
- 7 Press **▲** or **▼** to display **Memory Receive**.
- 8 Press **Memory Receive**.

- 9 Press **▲** or **▼** to display **Fax Forward**.
- 10 Press **Fax Forward**.
- 11 Enter the forwarding number (up to 20 digits) using the keyboard on the Touchscreen.
Press **OK**.
- 12 If **Fax Preview** is set to **Off**, press **Backup Print: On** or **Backup Print: Off**.

IMPORTANT

- If you choose **Backup Print: On**, the machine will also print the fax at your machine so you will have a copy. This is a safety feature in case there is a power failure before the fax is forwarded or a problem at the receiving machine.
- When you receive a colour fax, your machine prints the colour fax at your machine but does not forward the fax to the Fax Forwarding number you programmed.

- 13 Press .

Fax Storage

If you choose **Fax Storage**, your machine stores received faxes in the memory. You will be able to retrieve fax messages from another location using the Remote Retrieval commands.

If you have turned on **Fax Storage**, a backup copy will be printed at the machine.

- 1 Press  (Settings).
- 2 Press **All Settings**.
- 3 Press **▲** or **▼** to display **Fax**.
- 4 Press **Fax**.



- 5 Press ▲ or ▼ to display Setup Receive.
- 6 Press Setup Receive.
- 7 Press ▲ or ▼ to display Memory Receive.
- 8 Press Memory Receive.
- 9 Press ▲ or ▼ to display Fax Storage.
- 10 Press Fax Storage.
- 11 Press .

NOTE

Colour faxes cannot be stored in the memory. When you receive a colour fax, your machine prints the colour fax at your machine.

Printing a fax from the memory



If you have chosen Fax Storage, you can still print a fax from the memory when you are at your machine.

- 1 Press  (Settings).
- 2 Press All Settings.
- 3 Press ▲ or ▼ to display Fax.
- 4 Press Fax.
- 5 Press ▲ or ▼ to display Print Document.
- 6 Press Print Document.
- 7 Press OK.
- 8 Press .

NOTE

- (When Fax Preview is set to Off.)
You can also print a fax from the memory by pressing Print on the Touchscreen.
- When you print a fax from the memory, the fax data will be erased from your machine.

Turning off Memory Receive operations

- 1 Press  (Settings).
- 2 Press All Settings.
- 3 Press ▲ or ▼ to display Fax.
- 4 Press Fax.
- 5 Press ▲ or ▼ to display Setup Receive.
- 6 Press Setup Receive.
- 7 Press ▲ or ▼ to display Memory Receive.
- 8 Press Memory Receive.
- 9 Press Off.
- 10 Press .

NOTE

The Touchscreen will show you more options if there are still received faxes in the machine's memory. (See *Changing Memory Receive operations* on page 23.)

Changing Memory Receive operations

If there are received faxes in your machine's memory when you change the Memory Receive operations, the Touchscreen will ask you one of the following questions:

If all the received faxes have already been printed

- Erase all documents?
 - If you press **Yes**, faxes in the memory will be erased before the setting changes.
 - If you press **No**, faxes in the memory will not be erased and the setting will be unchanged.

If unprinted faxes remain in the memory

- Print all faxes?
 - If you press **Yes**, faxes in the memory will be printed before the setting changes. If a backup copy has already been printed, it will not be printed again.
 - If you press **No**, faxes in the memory will not be printed and the setting will be unchanged.

If received faxes are left in the machine's memory when you change to **PC Fax Receive** from another option [**Fax Forward** or **Fax Storage**], press **<USB>** or the name of the PC if you are on a network.

Press **OK**.

The Touchscreen will ask you the following question:

- Send Fax to PC?
 - If you press **Yes**, faxes in the memory will be sent to your PC before the setting changes. You will be asked if you want to turn on Backup Print.
(See Basic User's Guide: *PC-FAX Receiving (Windows®)*.)
 - If you press **No**, faxes in the memory will not be erased or transferred to your PC and the setting will be unchanged.

Remote Retrieval

You can call your machine from any touch-tone telephone or fax machine and then use the Remote Access Code and remote commands to retrieve fax messages.

Setting a Remote Access Code

The Remote Access Code lets you access the Remote Retrieval features when you are away from your machine. Before you can use the Remote Access and Retrieval features, you have to set up your own code. The factory default code is the inactive code (---*).

- 1 Press  (Settings).
- 2 Press `All Settings`.
- 3 Press `▲` or `▼` to display `Fax`.
- 4 Press `Fax`.
- 5 Press `▲` or `▼` to display `Remote Access`.
- 6 Press `Remote Access`.
- 7 Enter a three-digit code using numbers 0 to 9, *, or # using the keyboard on the Touchscreen.
Press `OK`.
(The preset '*' cannot be changed.)

NOTE

Do not use the same code as your Remote Activation Code (* 5 1 (* 9 1 for New Zealand)) or Remote Deactivation Code (# 5 1 (# 9 1 for New Zealand)). (See Basic User's Guide: *Operation from external and extension telephones.*)

- 8 Press .

NOTE

You can change your code at any time by entering a new one. If you want to deactivate your code, press and hold  in step 7 to restore the inactive setting (---*) and press `OK`.

Using your Remote Access Code

- 1 Dial your fax number from a touch-tone telephone or another fax machine.
- 2 When your machine answers, enter your Remote Access Code (3 digits followed by *) at once.
- 3 The machine signals if it has received any messages:
 - 1 long beep — Fax messages
 - No beeps — No messages
- 4 When the machine gives two short beeps, enter a command.
The machine will hang up if you wait longer than 30 seconds to enter a command.
The machine will beep three times if you enter an invalid command.
- 5 Press `9 0` to stop Remote Access when you have finished.
- 6 Hang up.

NOTE

- If your machine is set to `Manual` mode and you want to use the Remote Retrieval features, wait for about 100 seconds after it starts ringing, and then enter the Remote Access Code within 30 seconds.
- In some countries this function may not be available or supported by local telephone companies. (e.g. Australia)

Remote Fax commands

Follow the commands in the table to access features when you are away from the machine. When you call the machine and enter your Remote Access Code (3 digits followed by *), the system will give two short beeps and you must enter a remote command.

Remote commands		Operation details
95	Change the Fax Forwarding or Fax Storage settings	
	1 OFF	You can choose <code>OFF</code> after you have retrieved or erased all your messages.
	2 Fax Forwarding	One long beep means the change is accepted. If you hear three short beeps, the change was not accepted because something has not been set up (for example, a Fax Forwarding number has not been registered). You can register your Fax Forwarding number by entering 4. (See <i>Changing your Fax Forwarding number</i> on page 26.) Once you have registered the number, Fax Forwarding will work.
	4 Fax Forwarding number	
6 Fax Storage		
96	Retrieve a fax	
	2 Retrieve all faxes	Enter the number of a remote fax machine to receive stored fax messages. (See <i>Retrieving fax messages</i> on page 26.)
	3 Erase faxes from the memory	If you hear one long beep, fax messages have been erased from the memory.
97	Check the receiving status	
	1 Fax	You can check whether your machine has received any faxes. If yes, you will hear one long beep. If no, you will hear three short beeps.
98	Change the Receive Mode	
	1 External TAD	If you hear one long beep, your change has been accepted.
	2 Fax/Tel	
	3 Fax Only	
90	Exit	Pressing 9 0 allows you to exit Remote Retrieval. Wait for the long beep, then replace the handset.

Retrieving fax messages

You can call your machine from any touch-tone telephone and have your fax messages sent to another machine. Before you use this feature, you have to turn on Fax Storage or Fax Preview. (See *Fax Storage* on page 21 or see *Basic User's Guide: Fax Preview (Monochrome faxes only)*.)

- 1 Dial your fax number.
- 2 When your machine answers, enter your Remote Access Code (3 digits followed by *) at once. If you hear one long beep, you have messages.
- 3 When you hear two short beeps, press **9 6 2**.
- 4 Wait for a long beep, and then use the dial pad to enter the number of the remote fax machine where you want your fax messages sent, followed by **# #** (up to 20 digits).

NOTE

You cannot use * and # as dial numbers. However, press # if you want to create a pause.

- 5 Hang up after you hear your machine beep. Your machine will call the other fax machine, which will then print your fax messages.

Changing your Fax Forwarding number

You can change the default setting of your Fax Forwarding number from another touch-tone telephone or fax machine.

- 1 Dial your fax number.
- 2 When your machine answers, enter your Remote Access Code (3 digits followed by *) at once. If you hear one long beep, you have messages.
- 3 When you hear two short beeps, press **9 5 4**.
- 4 Wait for the long beep, enter the new number (up to 20 digits) of the remote fax machine you want your fax messages forwarded to using the dial pad, then enter **# #**.

NOTE

You cannot use * and # as dial numbers. However, press # if you want to create a pause.

- 5 Press **9 0** to stop Remote Access when you have finished.
- 6 Hang up after you hear your machine beep.

Additional receiving operations

Out of Paper Reception

As soon as the paper tray becomes empty during fax reception, the Touchscreen shows `No Paper Fed`. Put some paper in the paper tray. (See Basic User's Guide: *Loading paper and other print media*.)

If you don't put paper in the paper tray, the machine will continue receiving the fax. The remaining pages will be stored in the memory, if enough memory is available.

Further incoming faxes will also be stored in memory until the memory is full. To print the faxes, put fresh paper in the tray. When the memory is full, the machine will stop answering calls.

Printing a reduced incoming fax

If you choose `On`, the machine reduces each page of an incoming fax to fit on one sheet of Letter, Legal, Ledger, A4 or A3 size paper. The machine calculates the reduction ratio by using the page size of the fax and your Paper Size setting.

(MFC-J3520/MFC-J6520DW: See Basic User's Guide: *Paper Size* (MFC-J3520/MFC-J6520DW).)

(MFC-J3720/MFC-J6720DW: See Basic User's Guide: *Paper Size and Type* (MFC-J3720/MFC-J6720DW).)

- 1 Press  (Settings).
- 2 Press `All Settings`.
- 3 Press `▲` or `▼` to display `Fax`.
- 4 Press `Fax`.

- 5 Press `▲` or `▼` to display `Setup Receive`.
- 6 Press `Setup Receive`.
- 7 Press `▲` or `▼` to display `Auto Reduction`.
- 8 Press `Auto Reduction`.
- 9 Press `On` (or `Off`).
- 10 Press .

Receiving a fax at the end of a conversation

At the end of a conversation, you can ask the other party to fax you information before you both hang up. Make sure the ADF is empty.

- 1 Ask the other party to place the document in their machine and to press the `Start` or `Send` key.
- 2 When you hear the other machine's CNG tones (slowly repeating beeps), press `Fax Start`.

NOTE

If the Touchscreen is dark for Sleep mode, touch it to display `Fax Start`.

- 3 Press `Receive` to receive the fax.
- 4 Replace the handset of the external telephone.



Polling

Polling lets you set up your machine so other people can receive faxes from you, but they pay for the call. It also lets you call somebody else's fax machine and receive a fax from it, so you pay for the call. The polling feature needs to be set up on both machines for this to work. Not all fax machines support polling.

Polling Receive

Polling receive lets you call another fax machine to receive a fax.



Setting up Polling Receive

- 1 Do one of the following:
 - When Fax Preview is set to `Off`, press  (`Fax`).
 - When Fax Preview is set to `On`, press  (`Fax`) and then  (`Sending Faxes`).
- 2 Press `Options`.
- 3 Press `▲` or `▼` to display `Polling RX`.
- 4 Press `Polling RX`.
- 5 Press `Standard`.
- 6 Enter the fax number you are polling using `Address Book` or the dial pad on the `Touchpanel`.
- 7 Press `Fax Start`.

Setting up Secure Polling Receive



Secure Polling lets you restrict who can get the documents you set up to be polled.

Secure Polling only works with Brother fax machines. If you want to get a fax from a secured Brother machine you have to enter the secure code.

- 1 Do one of the following:
 - When Fax Preview is set to `Off`, press  (`Fax`).
 - When Fax Preview is set to `On`, press  (`Fax`) and then  (`Sending Faxes`).
- 2 Press `Options`.
- 3 Press `▲` or `▼` to display `Polling RX`.
- 4 Press `Polling RX`.
- 5 Press `Secure`.
- 6 Enter a four-digit secure code using the keyboard on the `Touchscreen`. This is the same as the security code of the fax machine you are polling. Press `OK`.
- 7 Enter the fax number you are polling by either using `Address Book` or the dial pad on the `Touchpanel`.
- 8 Press `Fax Start`.



Setting up Delayed Polling Receive

Delayed polling lets you set the machine to begin polling receive at a later time. You can only set up *one* delayed polling operation.

- 1 Do one of the following:
 - When Fax Preview is set to `Off`, press  (Fax).
 - When Fax Preview is set to `On`, press  (Fax) and then  (Sending Faxes).
- 2 Press `Options`.
- 3 Press `▲` or `▼` to display `Polling RX`.
- 4 Press `Polling RX`.
- 5 Press `Timer`.
- 6 Do one of the following:
 - If you have set `12h Clock` as the format in the `Clock Type` setting, enter the time (in 12-hour format) using the keyboard on the Touchscreen, and then press `AM` or `PM`. Press `OK`.
 - If you have set `24h Clock` in the `Clock Type` setting, enter the time (in 24-hour format) using the keyboard on the Touchscreen. Press `OK`. (For example, enter 19:45 for 7:45 PM.)
- 7 Enter the fax number you are polling by either using `Address Book` or the dial pad on the Touchpanel.
- 8 Press `Fax Start`. The machine makes the polling call at the time you entered.

Sequential Polling (Monochrome only)

Sequential polling lets you request documents from several fax machines in one operation.



- 1 Do one of the following:
 - When Fax Preview is set to `Off`, press  (Fax).
 - When Fax Preview is set to `On`, press  (Fax) and then  (Sending Faxes).
- 2 Press `Options`.
- 3 Press `▲` or `▼` to display `Polling RX`.
- 4 Press `Polling RX`.
- 5 Press `Standard`, `Secure` or `Timer`.
- 6 Do one of the following:
 - If you chose `Standard`, go to step 7.
 - If you chose `Secure`, enter a four-digit number, press `OK`, go to step 7.
 - If you chose `Timer`, do one of the following:
 - If you have set `12h Clock` in the `Clock Type` setting, enter the time (in 12-hour format) by pressing the keyboard on the Touchscreen, and then press `AM` or `PM`. Press `OK`.
 - If you have set `24h Clock` in the `Clock Type` setting, enter the time (in 24-hour format) by pressing the keyboard on the Touchscreen. Press `OK`. (For example, enter 19:45 for 7:45 PM.)

- 7 Press `Options`.
- 8 Press `▲` or `▼` to display `Broadcasting`.
- 9 Press `Broadcasting`.
- 10 Press `Add Number`.
- 11 You can add numbers to the broadcast in the following ways:
 - Press `Add Number` and enter a number using the keyboard on the Touchscreen.
Press `OK`.
 - Press `Add from Address book`. Press `▲` or `▼` to display the number you want to add to the broadcast. Press the check boxes of the numbers you want to add to the broadcast.
After you have checked all the numbers you want, press `OK`.
 - Press `Search in Address book`. Enter the first letter of the name and press `OK`.
Press the name, and then press the number you want to add to the broadcast.
- 12 After you have entered all the fax numbers by repeating steps 10 and 11, press `OK`.
- 13 Press `Fax Start`.
The machine polls each number or group in turn for a document.

Press  while the machine is dialling to cancel the polling process.

To cancel all sequential polling receive jobs, see *Cancelling a Sequential Polling Job* on page 30.

Cancelling a Sequential Polling Job

- 1 Press .
- 2 Do one of the following:
 - To cancel the entire sequential polling job, press `Entire Seq. Poll`. Go to step 3.
 - To cancel the current job, press the name or number being dialled on the Touchscreen. Go to step 4.
 - To exit without cancelling, press .
- 3 When the Touchscreen asks if you want to cancel the entire sequential polling job, do one of the following:
 - Press `Yes` to confirm.
 - To exit without cancelling, press `No`.
- 4 Do one of the following:
 - To cancel the current job, press `Yes`.
 - To exit without cancelling, press `No`.

Additional dialling operations



Combining Address Book numbers

Sometimes, you may want to choose from several long-distance carriers when you send a fax. Rates may vary depending on the time and destination. To take advantage of low rates, you can store the access codes of long-distance carriers and credit card numbers as Address Book numbers. (See Basic User's Guide: *Storing Address Book numbers*.)

You can store these long dialling sequences by dividing them and setting them up as separate Address Book numbers in any combination.

You can even include manual dialling using the dial pad.

For example, you might have stored '01632' on Address Book: Brother 1 and '960555' on Address Book: Brother 2. You can use them both to dial '01632-960555' as shown in the following example:

- 1 Press  (Fax).
- 2 Press  (Address Book).
- 3 Press ▲ or ▼ to display the number of Brother 1.
- 4 Press the number.
- 5 Press Apply.
- 6 Press Options.
- 7 Press ▲ or ▼ to display Address Book.
- 8 Press Address Book.

- 9 Press ▲ or ▼ to display the number of Brother 2.
- 10 Press the number.
- 11 Press Apply.
- 12 Press Fax Start.
You will dial '01632-960555'.

To temporarily change a number, you can use the dial pad to manually substitute part of the number. For example, to change the number to 01632-960556, you could enter the number (Brother 1: 01632) using



(Address Book), press Apply, and then press **960556** using the dial pad.



NOTE

If you must wait for another dial tone or signal at any point in the dialling sequence, create a pause in the number by pressing **Pause**. Each key press adds a 3.5 second delay. You can press **Pause** as many times as needed to increase the length of the pause.

Additional ways to store numbers



Storing Address Book numbers from the Outgoing Call history

You can also store Address Book numbers from the Outgoing Call history.

- 1 Press  (Fax).
- 2 Press  (Call History).
- 3 Press **Outgoing Call**.
- 4 Press **▲** or **▼** to display the number you want to store.
- 5 Press the number you want to store.
- 6 Press **Edit**.
- 7 Press **Add to Address Book**.
- 8 Press **Name**.
- 9 Enter the name (up to 16 characters) using the keyboard on the Touchscreen. Press **OK**.
(For help entering letters, see Basic User's Guide: *Entering Text*.)
- 10 If you want to store a second fax or telephone number, press **Address 2**. Enter the second fax or telephone number using the keyboard on the Touchscreen (up to 20 digits). Press **OK**.
- 11 Press **OK** to confirm the fax or telephone number you want to store.
- 12 Press .

Storing Address Book numbers from the Caller ID history (Only available for some countries)

If you have the Caller ID subscriber service from your telephone company, you can also store Address Book numbers from incoming calls in the Caller ID history. (See Basic User's Guide: *Caller ID*.)

- 1 Press  (Fax).
- 2 Press  (Call History).
- 3 Press **Caller ID history**.
- 4 Press **▲** or **▼** to display the name or number you want to store.
- 5 Press the name or number you want to store.
- 6 Press **Edit**.
- 7 Press **Add to Address Book**.
- 8 Press **Name**.
- 9 Enter the name (up to 16 characters) using the keyboard on the Touchscreen. Press **OK**.
(For help entering letters, see Basic User's Guide: *Entering Text*.)
- 10 If you want to store a second fax or telephone number, press **Address 2**. Enter the second fax or telephone number using the keyboard on the Touchscreen (up to 20 digits). Press **OK**.
- 11 Press **OK** to confirm the fax or telephone number you want to store.
- 12 Press .



Setting up Groups for Broadcasting

A Group, which is stored in the Address Book, allows you to send the same fax message to many fax numbers by pressing  (Fax),

 (Address Book), Apply and Fax Start.

(See *Broadcasting (Monochrome only)* on page 15.)

First, you'll need to store each fax number in the Address Book. (See Basic User's Guide: *Storing Address Book numbers.*) Then you can include them as numbers in the Group. Each Group uses up an Address Book number. You can have up to six Groups, or you can assign up to 198 numbers to a large Group.



- 1 Press  (Fax).
- 2 Press  (Address Book).
- 3 Press **Edit**.
- 4 Press **▲** or **▼** to display **Setup Groups**.
- 5 Press **Setup Groups**.
- 6 Press **Name**.
- 7 Enter the Group name (up to 16 characters) using the keyboard on the Touchscreen.
Press **OK**.
- 8 Press **Add/Delete**.
- 9 Add Address Book numbers to the Group by pressing them to display a red check mark. Press **OK**.
- 10 Read and confirm the displayed list of names and numbers you have chosen, and then press **OK** to save your Group.

- 11 Do one of the following:
 - To store another Group for broadcasting, repeat steps 3 to 10.
 - To finish storing Groups for broadcasting, press .

NOTE

You can print a list of all the Address Book numbers. (See *Reports* on page 36.)

Changing a Group name

- 1 Press  (Fax).
- 2 Press  (Address Book).
- 3 Press **Edit**.
- 4 Press **▲** or **▼** to display **Change**.
- 5 Press **Change**.
- 6 Press **▲** or **▼** to display the Group you want to change.
- 7 Press the Group.
- 8 Press **Name**.
- 9 Enter the new name (up to 16 characters) using the keyboard on the Touchscreen.
Press **OK**.
(For example, type **NEW CLIENTS**.)



NOTE

How to change the stored name:



If you want to change a character, press **◀** or **▶** to position the cursor to highlight the character you want to change, and then press . Enter the new character.
(For help entering letters, see Basic User's Guide: *Entering Text*.)

- 10 Press **OK**.
- 11 Press .

Deleting a Group

- 1 Press  (Fax).
- 2 Press  (Address Book).
- 3 Press `Edit`.
- 4 Press `▲` or `▼` to display `Delete`.
- 5 Press `Delete`.
- 6 Press `▲` or `▼` to display the Group you want to delete.
- 7 Press the Group name to add a check mark.
- 8 Press `OK`.
Press `Yes` to confirm.
- 9 Press .

Adding or Deleting a number in a Group

- 1 Press  (Fax).
- 2 Press  (Address Book).
- 3 Press `Edit`.
- 4 Press `▲` or `▼` to display `Change`.
- 5 Press `Change`.
- 6 Press `▲` or `▼` to display the Group you want to change.
- 7 Press the Group.
- 8 Press `▲` or `▼` to display `Add/Delete`.
- 9 Press `Add/Delete`.
- 10 Press `▲` or `▼` to display the number you want to add or delete.

- 11 Do the following for each number you want to change:
 - To add a number to the Group, press the check box of the number to *add* a check mark.
 - To delete a number from the Group, press the check box of the number to *remove* the check mark.
 Press `OK` to confirm all your changes.

- 12 Press `OK`.

- 13 Press .

Fax reports

Press  (Settings) on the Touchscreen to set up the Transmission Verification Report and the Journal Period.

Transmission Verification Report

You can use the Transmission Verification Report as proof that you sent a fax. (See Basic User's Guide: *Transmission Verification Report*.)

Fax Journal (activity report)

You can set the machine to print the Fax Journal report at specific intervals (every 50 faxes, 6, 12 or 24 hours, 2 or 7 days). If you set the interval to **Off**, you can still print the report by following the steps in *How to print a report* on page 36. The factory default is **Every 50 Faxes**.

- 1 Press  (Settings).
- 2 Press **All Settings**.
- 3 Press **▲** or **▼** to display **Fax**.
- 4 Press **Fax**.
- 5 Press **▲** or **▼** to display **Report Setting**.
- 6 Press **Report Setting**.
- 7 Press **Journal Period**.
- 8 Press **Journal Period**.
- 9 Press **▲** or **▼** to choose an interval. If you choose **Every 50 Faxes**, go to step 13.

- **6, 12, 24 hours, 2 or 7 days**

The machine will print the report at the chosen time and then erase all jobs from its memory. If the machine's memory is filled with the maximum 200 jobs before the time you chose has passed, the machine will print the Fax Journal report early and then erase all jobs from the memory. If you want an extra report before it is due to print, you can print it without erasing the jobs from the memory.

- **Every 50 Faxes**

The machine will print the Fax Journal report when the machine has stored 50 jobs.



- 10 To enter the time to start printing, do one of the following:
 - If you have set **12h Clock** in the **Clock Type** setting, press **Time** and enter the time (in 12-hour format) by pressing the keyboard on the Touchscreen, and then press **AM** or **PM**. Press **OK**.
 - If you have set **24h Clock** in the **Clock Type** setting, press **Time** and enter the time (in 24-hour format) by pressing the keyboard on the Touchscreen. Press **OK**. (For example, enter 19:45 for 7:45 PM.)
- 11 If you choose **Every 7 Days**, press **Day**.
- 12 Press **▲** or **▼** to display **Every Monday**, **Every Tuesday**, **Every Wednesday**, **Every Thursday**, **Every Friday**, **Every Saturday** or **Every Sunday**, and then press the first day for the 7-day countdown.
- 13 Press .

Reports

The following reports are available:

- **XMIT Verify**
Prints a Transmission Verification Report for your last transmission.
- **Address Book**
Prints a list of names and numbers stored in the Address Book memory, in alphabetical order.
- **Fax Journal**
Prints a list of information about the last incoming and outgoing faxes.
(TX: Transmit.) (RX: Receive.)
- **User Settings**
Prints a list of your settings.
- **Network Configuration**
Prints a list of your Network settings.
- **WLAN Report**
Prints a WLAN connection report.
- **Caller ID history**
(Only available for some countries)
Prints a list of the available Caller ID information about the last 30 received faxes and telephone calls.

How to print a report

- 1 Press  (Settings).
- 2 Press All Settings.
- 3 Press ▲ or ▼ to display Print Reports.
- 4 Press Print Reports.
- 5 Press ▲ or ▼ to display the report you want to print, and then press it.
- 6 Press OK.
- 7 Press .

Copy options

You can change the copy settings temporarily for the next copy.

The machine returns to its default settings after being idle for 1 minute.

Press **Copy**, and then press **Options**. Press **▲** or **▼** to scroll through the copy settings. When the setting you want is displayed, press it and choose your preferred option.

When you have finished changing the options, press **OK**, and then press **Mono Start** or **Colour Start**.

NOTE

- You can save some of the settings you use most often by setting them as the default settings. These settings will remain until you change them again. (See *Setting your changes as a new default* on page 49.)
- You can save some of the options you use most often by setting them as a Shortcut. (See *Saving copy options as a Shortcut* on page 50.)
- The Ink Save Mode, Thin Paper Copy, Book Copy and Watermark Copy features are supported by technology from Reallusion, Inc.  **REALLUSION**

Stop copying

To stop copying, press .

Improving copy speed and quality

You can choose from the speed and quality. The factory default is **Normal**.

NOTE

If you choose **Normal**, you can only choose **Plain Paper** in **Paper Type**.

■ Normal

Normal is the recommended mode for ordinary print outs. This produces good copy quality with good copy speed.



■ Best

Use **Best** mode to copy precise images, such as photographs. This provides the highest resolution and slowest speed.

- 1 Load your document.
- 2 Press  (**Copy**).
- 3 Enter the number of copies you want.
- 4 Press **Options**.
- 5 Press **▲** or **▼** to display **Quality**.
- 6 Press **Quality**.
- 7 Press **Normal** or **Best**.
- 8 Press **OK**.
- 9 If you do not want to change additional settings, press **Mono Start** or **Colour Start**.

Enlarging or reducing copies

You can choose an enlargement or reduction ratio. If you choose `Fit to Page`, your machine will adjust to the size you set in `Paper Size`.

- 1 Load your document.
- 2 Press  (`Copy`).
- 3 Enter the number of copies you want.
- 4 Press `Options`.
- 5 Press `▲` or `▼` to display `Enlarge/Reduce`.
- 6 Press `Enlarge/Reduce`.
- 7 Press `▲` or `▼` to display the available options, and then press the option you want to change.
- 8 Do one of the following:
 - If you chose `Enlarge` or `Reduce`, press the enlargement or reduction ratio you want to use.
 - If you chose `Custom (25-400%)`, press  to erase the displayed percentage, or press `◀` to move the cursor, and then enter an enlargement or reduction ratio from 25% to 400%.
Press `OK`.
 - If you chose `100%` or `Fit to Page`, go to step 9.

198% 10x15cm → A4
186% 10x15cm → Letter
141% A4→A3, A5→A4
100%
97% Letter → A4
93% A4 → Letter
83% Legal → A4
69% A3 → A4, A4 → A5
47% A4 → 10x15cm
Fit to Page
Custom (25-400%)

- 9 Read and confirm the displayed list of options you have chosen, and then press `OK`.
- 10 If you do not want to change additional settings, press `Mono Start` or `Colour Start`.

NOTE

- Page Layout is not available with Enlarge/Reduce.
- Page Layout, 2-sided Copy, ADF HighSpeed Mode, Book Copy, Sort, Thin Paper Copy, Watermark Copy and Remove Background Colour are not available with Fit to Page.
- Fit to Page does not work correctly when the document on the scanner glass or ADF is skewed by more than 3 degrees.

(For scanner glass)

Using the document guidelines on the left and top, place your document in the upper-left corner, with the document face down on the scanner glass.

(For ADF)

Place your document face up, short edge first in the ADF until the Touchscreen shows ADF Ready. and you feel the pages touch the feed rollers. Adjust the paper guides so they touch the sides of the document.

- Fit to Page is not available for Legal size documents.

Making N in 1 copies or a poster (Page Layout)

The N in 1 copy feature can help you save paper by letting you copy two or four pages onto one printed page.

The 1 to 2 feature copies one A3 or Ledger size page onto two A4 or Letter size pages. If you use this setting, use the scanner glass.

You can also produce a poster. When you use the poster feature, your machine divides your document into sections, then enlarges the sections so you can assemble them into a poster. If you want to print a poster, use the scanner glass.

NOTE

- ADF HighSpeed Mode, Book Copy, Sort, Thin Paper Copy, Ink Save Mode, Enlarge/Reduce, Watermark Copy and Remove Background Colour are not available with Page Layout.
- Auto Deskew is not available with Poster and 1 to 2 copy.
- 2-sided Copy is not available with Poster copy.

- 1 Load your document.
- 2 Press  (Copy).
- 3 Enter the number of copies you want. ¹

¹ You can only make one copy at a time when you are using 1 to 2 or Poster layout.
- 4 Press Options.
- 5 Press ▲ or ▼ to display Page Layout.
- 6 Press Page Layout.

- 7 Press ▲ or ▼ to display Off (1in1), 2in1 (Portrait), 2in1 (Landscape), 2in1 (ID)¹, 4in1 (Portrait), 4in1 (Landscape), 1 to 2, Poster (2x1), Poster (2x2) or Poster (3x3). Press the option you want to set.

¹ For information about 2 in 1 (ID), see *2 in 1 ID copy (Page Layout)* on page 42.

If you chose 2in1 or Poster (2x2) with A3 or Ledger size paper, go to step 8 to choose your Layout Format. If you choose another setting, go to step 9.

- 8 Press Layout Format. Do one of the following:

- If you chose 2in1 (Portrait) or 2in1 (Landscape), press Ledgerx2 → Ledgerx1, Letterx2 → Ledgerx1, A3x2 → A3x1, or A4x2 → A3x1.
- If you chose Poster (2x2), press Ledgerx1 → Ledgerx4, Letterx1 → Ledgerx4, A3x1 → A3x4, or A4x1 → A3x4.

- 9 Read and confirm the displayed list of settings you have chosen, and then press OK.

- 10 If you do not want to change additional settings, press Mono Start or Colour Start to scan the page. If you placed the document in the ADF or are making a poster, the machine scans the document and starts printing.

If you are using the scanner glass, go to step 11.

- 11 After the machine has scanned the page, press Yes to scan the next page.

- 12 Place the next page on the scanner glass. Press OK to scan the page. Repeat steps 11 and 12 for each page of the layout.

- 13 After all the pages have been scanned, press No to finish.

NOTE

- Make sure the paper size is set to A4, A3, Letter or Ledger.
- You can only make one colour copy at a time.
- You can only make one Poster and 1 to 2 copy at a time.
- Poster copy is not available when using transparencies.

If you are copying from the ADF, insert the document face up in the direction shown below:

- 2in1 (Portrait)



- 2in1 (Landscape)



- 4in1 (Portrait)

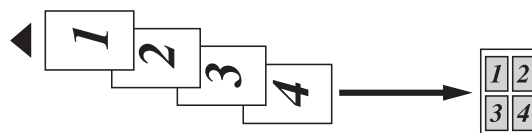

- 4in1 (Landscape)

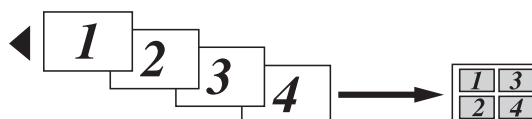

If you are copying from the scanner glass, place the document face down in the direction shown below:

■ 2in1 (Portrait)



■ 2in1 (Landscape)

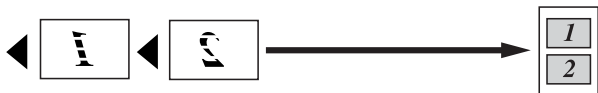

■ 4in1 (Portrait)



■ 4in1 (Landscape)



■ 1 to 2



■ Poster (2x1)

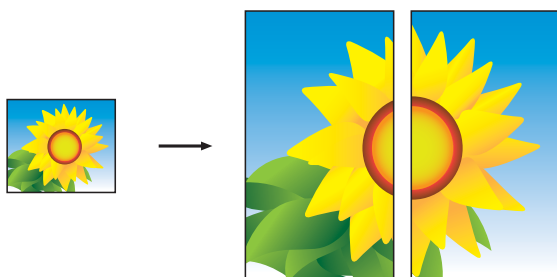

■ Poster (2x2)

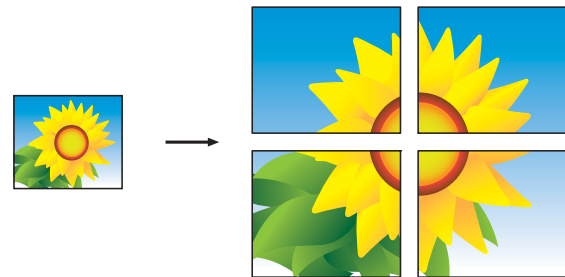

■ Poster (3x3)

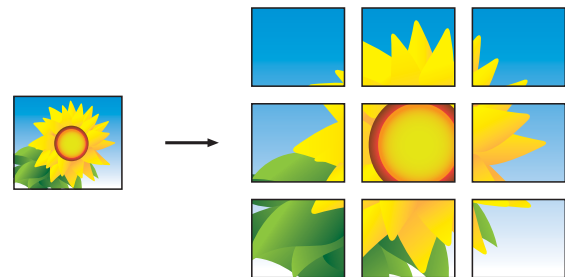

NOTE

The poster copies have overlapping portions so that you can easily paste them together.

2 in 1 ID copy (Page Layout)

You can copy both sides of your identification card onto one page, keeping the original card size. Make sure the paper size is set to A4 or Letter.

NOTE

You can copy an identification card to the extent permitted under applicable laws. (See Product Safety Guide: *Unlawful use of copying equipment.*)

- 1 Place your identification card *face down* near the left corner of the scanner glass as shown in the illustration.

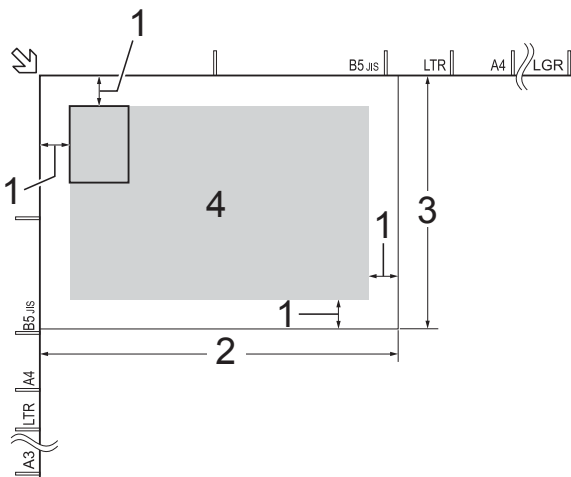

- 1 3 mm or greater (top, left)
- 2 210 mm
- 3 148 mm
- 4 scannable area

- 2 Press  (Copy).
- 3 Enter the number of copies you want.
- 4 Press **Options**.
- 5 Press **▲** or **▼** to display **Page Layout**.
- 6 Press **Page Layout**.
- 7 Press **▲** or **▼** to display **2 in 1 (ID)**.

- 8 Press **2 in 1 (ID)**.
- 9 Read and confirm the displayed list of settings you have chosen, and then press **OK**.
- 10 Press **Mono Start** or **Colour Start**. The machine starts scanning the first side of the identification card.
- 11 After the machine has scanned the first side, press **Yes**. Turn over the identification card and press **OK** to scan the other side.

NOTE

- ADF HighSpeed Mode, Book Copy, Sort, 2-sided Copy, Thin Paper Copy, Ink Save Mode, Enlarge/Reduce, Watermark Copy and Remove Background Colour are not available with 2 in 1 (ID).
- You can only make one colour copy at a time.

Sorting copies

You can sort multiple copies. Your copies will be in the order 123, 123, 123, and so on.

We recommend you load single-sided documents in the ADF for sorting copies. For 2-sided documents and books use the scanner glass.

- 1 Load your document.
- 2 Press  (Copy).
- 3 Enter the number of copies you want.
- 4 Press Options.
- 5 Press ▲ or ▼ to display Stack/Sort.
- 6 Press Stack/Sort.
- 7 Press Sort.
- 8 Read and confirm the displayed list of settings you have chosen, and then press OK.
- 9 If you do not want to change additional settings, press Mono Start or Colour Start.
If you placed the document in the ADF, the machine scans the document and starts printing.

If you are using the scanner glass, go to step 10.

- 10 After the machine scans the page, press Yes to scan the next page.
- 11 Place the next page on the scanner glass. Press OK to scan the page. Repeat steps 10 and 11 until all the pages have been scanned.
- 12 Press No to finish scanning. The machine starts printing.

NOTE

Fit to Page, Page Layout and Book Copy are not available with Sort.

Adjusting Density

You can adjust the copy density to make copies darker or lighter.

- 1 Load your document.
- 2 Press  (Copy).
- 3 Enter the number of copies you want.
- 4 Press Options.
- 5 Press ▲ or ▼ to display Density.
- 6 Press Density.
- 7 Press the level of density you want, from Light to Dark.
- 8 Read and confirm the displayed list of settings you have chosen, and then press OK.
- 9 If you do not want to change additional settings, press Mono Start or Colour Start.

Ink Save Mode

Ink Save Mode can help you save ink. The machine prints the colours lighter and emphasises the outlines of the images as shown below:

The amount of ink saved will vary depending on the document.

Ink Save Mode: Off

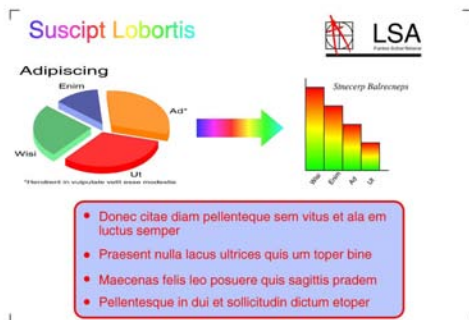

Ink Save Mode: On

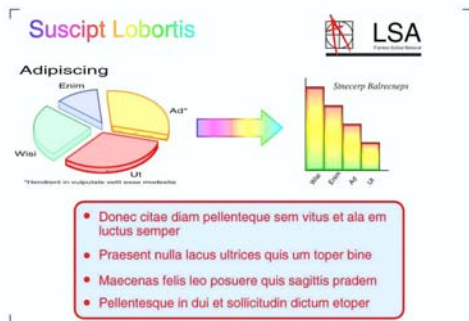

(The above screens are used in ISO/IEC 24712.)

- 1 Load your document.
- 2 Press  (Copy).
- 3 Enter the number of copies you want.
- 4 Press Options.
- 5 Press ▲ or ▼ to display Advanced Settings.

- 6 Press Advanced Settings.
- 7 Press ▲ or ▼ to display Ink Save Mode.
- 8 Press Ink Save Mode.
- 9 Read and confirm the displayed list of settings you have chosen, and then press OK.
- 10 If you do not want to change any additional settings, press Mono Start or Colour Start.

NOTE

- ADF HighSpeed Mode, Book Copy, Thin Paper Copy, Auto Des skew, Page Layout, Watermark Copy and Remove Background Colour are not available with Ink Save Mode.
- Ink Save Mode may make your printouts look different from your original document.

Thin Paper Copy

If your document is a 2-sided Copy on thin paper, choose **Thin Paper Copy** so the print on the other side does not bleed through.

- 1 Load your document.
- 2 Press  (Copy).
- 3 Enter the number of copies you want.
- 4 Press **Options**.
- 5 Press **▲** or **▼** to display **Advanced Settings**.
- 6 Press **Advanced Settings**.
- 7 Press **▲** or **▼** to display **Thin Paper Copy**.
- 8 Press **Thin Paper Copy**.
- 9 Read and confirm the displayed list of settings you have chosen, and then press **OK**.
- 10 Press **Mono Start** or **Colour Start**.

NOTE

ADF HighSpeed Mode, Fit to Page, Page Layout, Auto Deskew, Ink Save Mode, Book Copy, Watermark Copy **and** Remove Background Colour **are not available with Thin Paper Copy**.

Auto Deskew

If your scanned copy is skewed, your machine can correct the data.

This setting is only available when using the scanner glass.

- 1 Load your document.
- 2 Press  (Copy).
- 3 Enter the number of copies you want.
- 4 Press **Options**.
- 5 Press **▲** or **▼** to display **Auto Deskew**.
- 6 Press **Auto Deskew**.
- 7 Press **Auto (or Off)**.
- 8 Read and confirm the displayed list of settings you have chosen, and then press **OK**.
- 9 If you do not want to change additional settings, press **Mono Start** or **Colour Start**.

NOTE

- 1 to 2, Poster, Ink Save Mode, Thin Paper Copy, Book Copy, Watermark Copy, Remove Background Colour **and** ADF HighSpeed Mode **are not available with Auto Deskew**.
- You cannot use this setting with Ledger, A3 or paper smaller than 64 mm × 91 mm.
- This setting is only available for paper that is rectangular or square.
- Auto Deskew is only available if the document is skewed by less than 3 degrees.
- Auto Deskew may not work correctly if your document is too thick.

Book Copy

Book Copy corrects dark borders and skew when copying from the scanner glass. Your machine can correct the data.

- 1 Load your document.
- 2 Press  (Copy).
- 3 Enter the number of copies you want.
- 4 Press **Options**.
- 5 Press **▲** or **▼** to display **Advanced Settings**.
- 6 Press **Advanced Settings**.
- 7 Press **▲** or **▼** to display **Book Copy**.
- 8 Press **Book Copy**.
- 9 Read and confirm the displayed list of settings you have chosen, and then press **OK**.
- 10 If you do not want to change additional settings, press **Mono Start** or **Colour Start**.

NOTE

ADF HighSpeed Mode, Page Layout, Sort, 2-sided Copy, Auto Deskew, Ink Save Mode, Fit to Page, Thin Paper Copy, Watermark Copy and Remove Background Colour are not available with Book Copy.

Watermark Copy

You can copy your document and include a watermark, select one from the list of template watermarks.

NOTE

ADF HighSpeed Mode, Fit to Page, Page Layout, Auto Deskew, Thin Paper Copy, Ink Save Mode, Book Copy and Remove Background Colour are not available with Watermark Copy.

Using a template

- 1 Load your document.
- 2 Press  (Copy).
- 3 Enter the number of copies you want.
- 4 Press **Options**.
- 5 Press **▲** or **▼** to display **Advanced Settings**.
- 6 Press **Advanced Settings**.
- 7 Press **▲** or **▼** to display **Watermark Copy**.
- 8 Press **Watermark Copy**.
- 9 Change the watermark settings by pressing the options displayed on the Touchscreen as required. (For more information, see *Watermark Copy Settings* on page 47.) Press **OK**.
- 10 Press **OK** to confirm the watermark.
- 11 Press **Mono Start** or **Colour Start**.

Watermark Copy Settings

Option1	Option2	Option3
Watermark Copy	Text	CONFIDENTIAL* DRAFT COPY IMPORTANT URGENT
	Position	A B C D E* F G H I Pattern
	Size	Small Medium* Large
	Angle	-90° -45°* 0° 45° 90°
	Transparency	-2 -1 0* +1 +2
	Colour	Black* Green Blue Purple Red Orange Yellow
The default settings are shown in Bold with an asterisk.		

Remove Background Colour

You can remove the background colour of the document when copying. This will save some ink and may make the copy more readable.

NOTE

This function is for use only when making colour copies. The background colour is automatically removed for all monochrome copies.

- 1 Load your document.
- 2 Press  (Copy).
- 3 Enter the number of copies you want.
- 4 Press Options.
- 5 Press ▲ or ▼ to display Advanced Settings.
- 6 Press Advanced Settings.
- 7 Press ▲ or ▼ to display Remove Background Colour.
- 8 Press Remove Background Colour.
- 9 Press Low, Medium or High.
- 10 Press OK.
- 11 Press Colour Start.

NOTE

ADF HighSpeed Mode, Fit to Page, Page Layout, Auto Deskew, Ink Save Mode, Thin Paper Copy, Book Copy and Watermark Copy are not available with Remove Background Colour.

2-sided copying

You can reduce the amount of paper used for copies by copying on both sides of the paper.

We recommend you load single-sided documents in the ADF for 2-sided copying. For 2-sided documents and books, use the scanner glass.

(Long edge flip)

Portrait

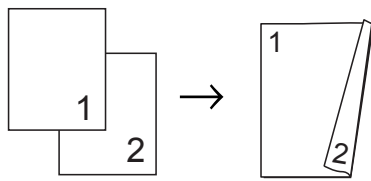

Landscape

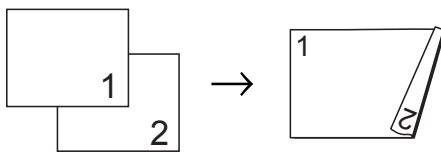

(Short edge flip)

Portrait

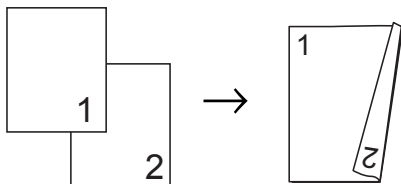

Landscape

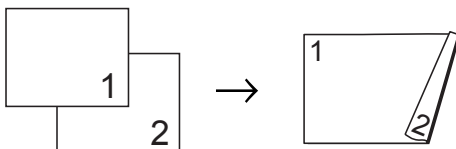

NOTE

- 2in1 (ID), Poster, Book Copy and Fit to Page are not available with 2-sided Copy.
- You can use only A4, A5, A3, Letter, Legal or Ledger size plain paper.

- 1 Load your document.
- 2 Press  (Copy).
- 3 Enter the number of copies you want.
- 4 Press *Options*.
- 5 If you want to sort multiple copies, press **▲** or **▼** to display *Stack/Sort*.
- 6 Press *Stack/Sort*.
- 7 Press *Sort*.
- 8 Press **▲** or **▼** to display *2-sided Copy*.
- 9 Press *2-sided Copy*.
- 10 Press **▲** or **▼** to display the 2-sided copy type you want, and press *Portrait Long Edge Flip*, *Landscape Long Edge Flip*, *Portrait Short Edge Flip* or *Landscape Short Edge Flip*.
- 11 Read and review the message on the Touchscreen, and then press **OK**.
- 12 Review your settings on the Touchscreen, and then press **OK**.
- 13 Press *Mono Start* or *Colour Start*. If you placed the document in the ADF, the machine scans the document and starts printing.

If you are using the scanner glass, go to step 14.

14 The Touchscreen shows:

Turn over the document (or Flip the book), then press [Scan]. When you finish, press [Complete].

Place the next page on the scanner glass and press Scan.

Press OK.

The machine starts printing.

15 If you pressed Sort for multiple copies, repeat step 14 for each page. After all the pages have been scanned, press Complete.

The machine starts printing.

DO NOT touch printed pages until they are ejected the second time. The machine will print and eject the first side, and then pull the paper back in to print the second side.

NOTE

If your document causes paper jams, try using one of the special 2-sided copy settings. Press Advanced after step 9, and then choose 2-sided 1 or 2-sided 2.



2-sided 1 helps avoid paper jams when copying by allowing more time for the ink to dry. Choosing 2-sided 2 allows more time for the ink to dry while also using less ink.

Setting your changes as a new default

You can save the settings for the copy options you use most often—such as ADF HighSpeed Mode, Quality, Tray Select¹, Enlarge/Reduce, Density, Page Layout, Auto Deskew, 2-sided Copy and Advanced Settings—by setting them as the defaults.

¹ MFC-J3720/MFC-J6720DW only

These settings will remain until you change them again.

- 1 Press  (Copy).
- 2 Press Options.
- 3 Press ▲ or ▼ to display the settings, and press on the setting you want to change. Then press the new option. Repeat this step for each setting you want to change.
- 4 After changing the last setting, press ▲ or ▼ to display Set New Default.
- 5 Press Set New Default.
- 6 The Touchscreen asks you again to confirm if you want to set the changes as the new default settings. Press Yes.
- 7 Press .

Restoring all settings to the factory default

You can restore the copy settings that you have changed—such as ADF HighSpeed Mode, Quality, Tray Select ¹, Enlarge/Reduce, Density, Page Layout, Auto Deskew, 2-sided Copy and Advanced Settings—to the factory default.

¹ MFC-J3720/MFC-J6720DW only

- 1 Press  (Copy).
- 2 Press Options.
- 3 Press ▲ or ▼ to display Factory Reset.
- 4 Press Factory Reset.
- 5 Press Yes.
- 6 Press .

Saving copy options as a Shortcut

You can store the copy options you use frequently by saving them as a Shortcut.

- 1 Press  (Copy).
- 2 Press Options.
- 3 Press ▲ or ▼ to display ADF HighSpeed Mode, Quality, Paper Type, Paper Size, Tray Select ¹, Enlarge/Reduce, Density, Stack/Sort, Page Layout, Auto Deskew, 2-sided Copy or Advanced Settings, and then press the setting you want to change. Then press the new option you want.

Repeat this step for each setting you want to change.

¹ MFC-J3720/MFC-J6720DW only

- 4 When you have finished choosing new options, press Save as Shortcut.
- 5 Read and confirm the displayed list of options you have chosen for the Shortcut, and then press OK.
- 6 Enter a name for the Shortcut using the keyboard on the Touchscreen. (For help entering letters, see Basic User's Guide: *Entering Text*.) Press OK.
- 7 Press OK to save your Shortcut.

A3 Copy Shortcuts

A3 Copy Shortcut

You can copy your document in A3 or Ledger size paper with a format such as Note style. Also you can make 2 in 1, enlarged and reduced copies.

■ **A3**

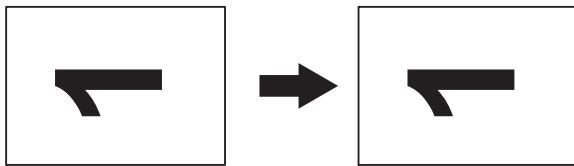

■ **A3 2in1**

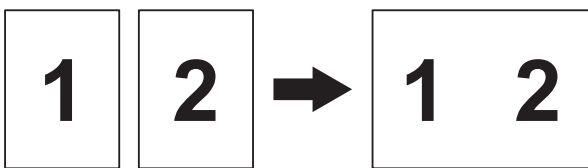

■ **A4 + Note (L)**

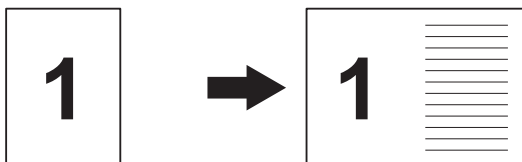

■ **A4 + Note (P)**

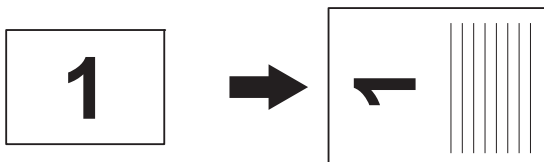

■ **A4 + Grid**

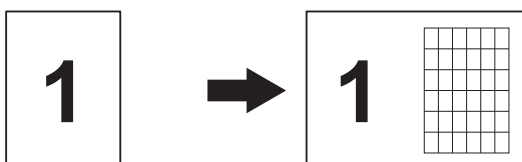

■ **A4 + Blank**

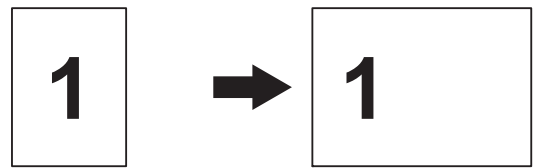

■ **A4 Centre**

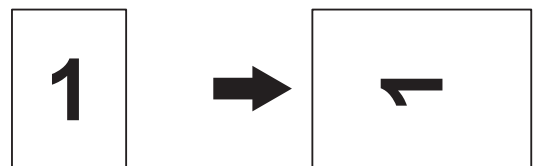

■ **A4 → A3**

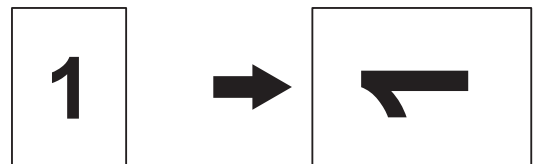

■ **A3→A4**

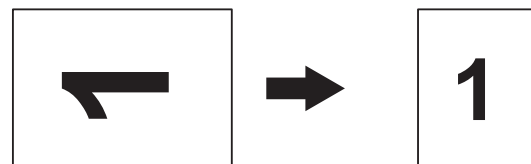

NOTE

- You can use only A3 or Ledger size plain paper, with the exception that you must use A4 or Letter size plain paper when choosing A3→A4.
- If you are producing multiple colour copies, A3 2in1, A4 + Note (L), A4 + Note (P), A4 + Grid and A4 + Blank are not available.
- (P) means Portrait and (L) means Landscape.
- You can enlarge a copy only when using A4 → A3, and reduce a copy only when using A3→A4.

- 1 Load your document.
 - 2 Press ◀ or ▶ to display A3 Copy Shortcuts.
 - 3 Press A3 Copy Shortcuts.
 - 4 If information appears on the Touchscreen, read it and then press OK to confirm it.
 - 5 Press ◀ or ▶ to display A3 2in1, A3, A4 → A3, A3→A4, A4 + Note (L), A4 + Note (P), A4 + Grid, A4 + Blank or A4 Centre, and then press the option you want.
 - 6 Enter the number of copies you want.
 - 7 Do one of the following:
 - If you want to change additional settings, go to step 8.
 - If you do not want to change additional settings, go to step 12.
 - 8 Press Options.
 - 9 Press the setting you want to change.
 - 10 Press your new option.

Repeat steps 9 and 10 to change other settings as needed.
 - 11 Press OK when you have finished changing the options.
 - 12 Press Mono Start or Colour Start.
- If you are using the scanner glass when choosing A3 2in1, go to step 13.**
- 13 After the machine has scanned the page, press Yes to scan the next page.
 - 14 Place the next page on the scanner glass. Press OK to scan the page.

Repeat steps 13 and 14 for each page of the layout.

PhotoCapture Center™ operations

Memory cards, USB Flash drives and folder structures

Your machine is designed to be compatible with modern digital camera image files, memory cards and USB Flash drives; however, please read the bullet points to avoid errors:

- The image file extension must be .JPG (other image file extensions like .JPEG, .TIF, .GIF and so on will not be recognized).
- Direct PhotoCapture Center™ printing must be performed separately from PhotoCapture Center™ operations using the PC. (Simultaneous operation is not available.)
- The machine can read up to 999 files ¹ on a memory card or USB Flash drive.
 - ¹ The folder inside memory cards or USB Flash drives are also counted.
- The DPOF file on the memory cards must be in a valid DPOF format. (See *DPOF printing* on page 59.)

Please be aware of the following:

- When printing an index or image, the PhotoCapture Center™ will print all the valid images, even if one or more images have been corrupted. Corrupted images will not be printed.

■ (Memory card users)

Your machine is designed to read memory cards that have been formatted by a digital camera.

When a digital camera formats a memory card, it creates a special folder into which it copies image data. If you need to modify the image data stored on a memory card with your PC, we recommend that you do not modify the folder structure created by the digital camera. When saving new or modified image files to the memory card, we also recommend you use the same folder your digital camera uses. If the data is not saved to the same folder, the machine may not be able to read the file or print the image.

■ (USB Flash drive users)

This machine supports USB Flash drives that have been formatted by Windows®.

Movie printing

You can print images from movie files that are stored on a memory card or USB Flash drive.

Movie files are automatically split by duration into 9 parts, and placed in 3 rows so you can see and print the scenes.

NOTE

- You cannot choose a particular movie scene.
- You can use AVI or MOV movie file formats (Motion JPEG only). However, if an AVI file size is 1 GB or more (the shooting time is about 30 minutes) or a MOV file size is 2 GB or more (the shooting time is about 60 minutes), these files cannot be printed.
- If the data for a divided scene is corrupted, the part for that scene will be blank.

Print Images

Print Index (Thumbnails)

The PhotoCapture Center™ assigns numbers for images (such as No.1, No.2, No.3, and so on).



→ NO.1
DEI.JPG 01.01.2009
100KB

The PhotoCapture Center™ uses these numbers to identify each picture. You can print a thumbnail page to show all the pictures on the memory card or USB Flash drive.

NOTE

Only file names that are 20 characters or less will be printed correctly on the index sheet.

- 1 Open the media slot cover.
- 2 Put the memory card or USB Flash drive in the correct slot.
- 3 Press **Photo**.
- 4 Press **◀** or **▶** to display **Index Print**.
- 5 Press **Index Print**.
- 6 Press **Print Index Sheet**.
- 7 Do one of the following:
 - Press **Print Settings** to change the paper type or the paper size you are using. Go to step 8.
 - If you do not want to change the paper settings, press **Start**.
- 8 Press **Paper Type**.

- 9 Press ▲ or ▼ to display Plain Paper, Inkjet Paper, Brother BP71 or Other Glossy, and then press the option you want.
- 10 Press Paper Size.
- 11 Press A4 or Letter.
- 12 Press OK.
- 13 Press Start to print.

Printing Photos

Before you can print an individual image, you have to know the image number.

- 1 Open the media slot cover.
- 2 Put the memory card or USB Flash drive in the correct slot.
- 3 Press Photo.
- 4 Print the Index. (See *Print Index (Thumbnails)* on page 54.)
- 5 Press ◀ or ▶ to display Index Print.
- 6 Press Index Print.
- 7 Press Print Photos.
- 8 Enter the image number that you want to print from the thumbnails printed on the Index page.
After you have chosen the image numbers, press OK.

NOTE

- You can enter the numbers at one time by using a comma or a hyphen. For example, Enter 1,3,6 to print images No.1, No.3 and No.6. Enter 1-5 to print images No.1 to No.5.
- You can enter up to 12 characters (including commas and hyphens) for the image numbers you want to print.

- 9 Enter the number of copies you want using the dial pad on the Touchpanel.
- 10 Do one of the following:
 - Press Print Settings to change the print settings. (See *PhotoCapture Center™ print settings* on page 59.)
 - If you do not want to change any settings, press Start to print.

Enhance Photos

You can edit and add effects to your photos and view them on the Touchscreen before printing.

NOTE

The Enhance Photos feature is supported by technology from Reallusion, Inc.  **REALLUSION**

- 1 Open the media slot cover.
- 2 Put the memory card or USB Flash drive in the correct slot.
- 3 Press Photo.
- 4 Press ◀ or ▶ to display Enhance Photos.
- 5 Press Enhance Photos.

NOTE









- Four thumbnails are displayed at a time with the current page number and total number of pages listed below the thumbnails.
- Press ◀ or ▶ repeatedly to select each page of photos, or hold down to scroll through all pages of photos.

- 6 Press a photo from the thumbnails.
- 7 Choose Enhance or Crop by pressing it to display a red check mark, and then press OK.

- 8 If you chose **Enhance** in step 7, press the effect you wish to add. Press **OK**.

NOTE



- There are ten ways you can add effects to your photo.

	(Auto Correct) The machine decides the suitable effect for your photo.
	(Enhance Skin) Best used for adjusting portrait photographs. It adjusts human skin colour. Press ◀ or ▶ to adjust the level of contrast.
	(Enhance Scenery) Best used for adjusting landscape photographs. It highlights green and blue areas in your photo. Press ◀ or ▶ to adjust the level of contrast.
	(Remove Red-Eye) The machine will attempt to remove red-eye from your photo. If red-eye detection fails, you can press Try Again to re-detect.
	(Night Scene) Night Scene is best used for adjusting night view photographs to make them more vivid. Press ◀ or ▶ to adjust the level of contrast.
	(Fill Light) Fill Light is best used for adjusting photographs against the light. Press ◀ or ▶ to adjust the level of contrast.
	(Whiteboard) Whiteboard is best used for adjusting photographs. It detects letters on a whiteboard in your photo and makes them more legible.
	(Monochrome) You can convert your photo to monochrome.
	(Sepia) You can convert the colour of your photo to sepia.

	(Auto Correct & Remove Red-Eye) The machine decides the suitable effects for your photo. It will also attempt to remove red-eye from your photo.
---	---

- There are some cases when red-eye may not be removed.
 - When the face is too small in the image.
 - When the face is turning too far up, down, left or right.
- Press **Cancel** to return to the list of effects.
- If your photo is very small or has irregular proportions, you may not be able to crop or enhance it. The Touchscreen will display **Image Too Small** or **Image Too Long**.

- 9 If you chose **Crop** in step 7, adjust the red frame around your photo. The part inside of the red frame will be printed.

- Press  or  to enlarge or reduce the frame size.
- Press ▲, ▼, ◀ or ▶ to move the position of the frame.
- Press  to rotate the frame.

Press **OK** when you have finished adjusting the frame setting. Press **OK** to confirm.

NOTE

If your photo is very small or has irregular proportions, you may not be able to crop or enhance it. The Touchscreen will display **Image Too Small** or **Image Too Long**.

- 10 Enter the number of copies you want, either by pressing **+** or **-** or using the dial pad on the Touchpanel. Press **OK**.

- 11 Do one of the following.
 - Press **Print Settings** to change the print settings. (See *PhotoCapture Center™ print settings* on page 59.)
 - If you do not want to change any settings, press **Start** to print.

ID Photo Print

You can select a photo stored in a memory card or USB Flash drive and print ID photos for your resume, passport and so on. You can print four ID photos on one sheet of paper.

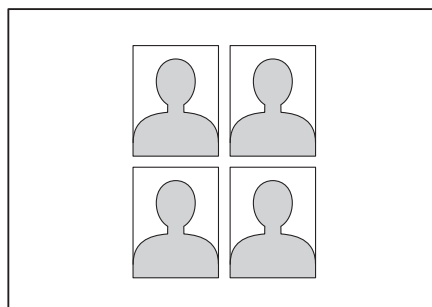

NOTE

Just one photo will be printed when you choose 2x2inch or 50x70mm (2x2.75in) in ID Photo Size, and 10x15cm in Paper Size.

- 1 Open the media slot cover.
- 2 Put the memory card or USB Flash drive in the correct slot.
- 3 Press **Photo**.
- 4 Press **◀** or **▶** to display ID Photo Print.
- 5 Press **ID Photo Print**.
- 6 Press **◀** or **▶** to display each photo. When the photo you want is displayed, press it.

- 7 Press **▲** or **▼** to display 25x36mm, 35x45mm, 36x51mm, 45x45mm, 45x55mm, 35x48mm, 50x70mm (2x2.75in) or 2x2inch, and then press the option you want to set as the photo size.

NOTE

The machine automatically crops the photo according to the size you choose. You cannot trim the photo further.

- 8 Confirm the image displayed on the Touchscreen. Rotate the image if necessary by pressing .
- 9 Press **OK**.
- 10 Do one of the following:
 - Press **Print Settings** to change the print settings. Go to step 11.
 - If you do not want to change any settings, press **Start** to print.

- 11 Do one of the following:
 - To change the print quality, press `Print Quality`.
Press `Normal` or `Photo`.
 - To change the paper type, press `Paper Type`.
Press `▲` or `▼` to display `Plain Paper`, `Inkjet Paper`, `Brother BP71` or `Other Glossy`, and then press the option you want to set.
 - To change the paper size, press `Paper Size`.
Press `▲` or `▼` to display `10x15cm`, `13x18cm`, `A4` or `Letter`, and then press the option you want to set.
 - To add enhancement effects, press `Photo Enhance`.
Press `▲` or `▼` to display `Auto Correct`, `Remove Red-Eye`, `Auto Correct & Remove Red-Eye` or `Off`, and then press the option you want to set.
- 12 When you have finished changing settings, press `OK`.
- 13 Press `Start`.

Slide Show

You can view all your photos on the Touchscreen using `Slide Show`. You can also choose a photo during the operation.

- 1 Open the media slot cover.
- 2 Put the memory card or USB Flash drive in the correct slot.
- 3 Press `Photo`.
- 4 Press `◀` or `▶` to display `Slide Show`.
- 5 Press `Slide Show`.
- 6 Do one of the following:
 - If you want to change the length of time the Touchscreen shows each photo, press `Show Each Photo for`. Press `▲` or `▼` to display `3Secs`, `10Secs`, `30Secs`, `1Min` or `5Mins`, and then press the option you want to set.
 - If you do not want to change the settings, press `Start`.
- 7 Press  to finish `Slide Show`.

Printing a photo during a Slide Show

- 1 To print an image during a slide show, press the image when it appears on the Touchscreen.
- 2 Enter the number of copies you want using the dial pad on the Touchpanel.
- 3 Do one of the following:
 - Press `Print Settings` to change the print settings.
(See *PhotoCapture Center™ print settings* on page 59.)
 - If you do not want to change any settings, press `Start` to print.

DPOF printing

DPOF stands for Digital Print Order Format.

Major digital camera manufacturers (Canon Inc., Eastman Kodak Company, FUJIFILM Corporation, Panasonic Corporation and Sony Corporation) created this standard to make it easier to print images from a digital camera.

If your digital camera supports DPOF printing, you will be able to choose the images and the number of copies you want to print on the display of the digital camera.

When a memory card containing DPOF information is put into your machine, you can print the chosen image easily.

- 1 Open the media slot cover.
- 2 Put the memory card or USB Flash drive in the correct slot.
The DPOF file on the memory card or USB Flash memory drive must be in a valid DPOF format.
- 3 Press ▲ or ▼ to display DPOF.
- 4 Press DPOF.
- 5 Do one of the following:
 - Press `Print Settings` to change the print settings. (See *PhotoCapture Center™ print settings* on page 59.)
 - If you do not want to change any settings, press `Start` to print.

NOTE

A DPOF File error can occur if the print order that was created on the camera has been corrupted. Delete and recreate the print order using your camera to correct this problem. For instructions on how to delete or recreate the print order, refer to your camera manufacturer's support website or accompanying documentation.

PhotoCapture Center™ print settings

You can change the print settings temporarily for the next print job.

The machine returns to its default settings after being idle for 1 minute.

NOTE

You can save the print settings you use most often by setting them as the default settings. (See *Setting your changes as a new default* on page 65.)

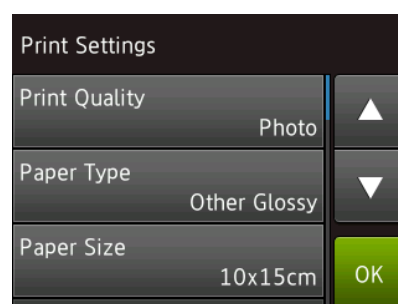

Print Quality

- 1 Open the media slot cover.
- 2 Put the memory card or USB Flash drive in the correct slot.
- 3 Press `Photo`.
- 4 Press ◀ or ▶ to display `View Photos`.
- 5 Press `View Photos`.
- 6 Press ◀ or ▶ to display each photo. When the photo you want is displayed, press it, and then press `OK`.
- 7 Press `OK`.
- 8 Press `Print Settings`.
- 9 Press ▲ or ▼ to display `Print Quality`.

- 10 Press `Print Quality`.
- 11 Press `Normal` or `Photo`.
- 12 If you do not want to change additional settings, press  or `OK`. Press `Start` to print.

NOTE

If you choose `Inkjet Paper` in `Paper Type`, you can only choose `Photo`.

Paper options

Paper Type







- 1 Open the media slot cover.
- 2 Put the memory card or USB Flash drive in the correct slot.
- 3 Press `Photo`.
- 4 Press `◀` or `▶` to display `View Photos`.
- 5 Press `View Photos`.
- 6 Press `◀` or `▶` to display each photo. When the photo you want is displayed, press it, and then press `OK`.
- 7 Press `OK`.
- 8 Press `Print Settings`.
- 9 Press `▲` or `▼` to display `Paper Type`.
- 10 Press `Paper Type`.
- 11 Press `▲` or `▼` to display `Plain Paper`, `Inkjet Paper`, `Brother BP71` or `Other Glossy`, and then press the option you want.
- 12 If you do not want to change additional settings, press  or `OK`. Press `Start` to print.

Paper Size and Print Size

- 1 Open the media slot cover.
- 2 Put the memory card or USB Flash drive in the correct slot.
- 3 Press `Photo`.
- 4 Press `◀` or `▶` to display `View Photos`.
- 5 Press `View Photos`.
- 6 Press `◀` or `▶` to display each photo. When the photo you want is displayed, press it, and then press `OK`.
- 7 Press `OK`.
- 8 Press `Print Settings`.
- 9 Press `▲` or `▼` to display `Paper Size`.
- 10 Press `Paper Size`.
- 11 Press `▲` or `▼` to display `10x15cm`, `13x18cm`, `A4`, `A3`, `Letter` or `Ledger`. Press the option you want to set. Do one of the following:
 - If you chose `A4` or `Letter`, go to step 12.
 - If you chose `10x15cm`, `13x18cm`, `A3` or `Ledger`, go to step 13.

- 12 Press ▲ or ▼ to display **Print Size**.
Press **Print Size**.
Press ▲ or ▼ to display the options in the following table, and then press the option you want to set.

Example: Printed position for A4 size paper

1 8x10cm	2 9x13cm	3 10x15cm
		
4 13x18cm	5 15x20cm	6 Max. Size
		

- 13 If you do not want to change additional settings, press  or **OK**.
Press **Start** to print.

Auto Correct

Auto Correct is available for most photos. The machine decides the suitable effect for your photo.

- 1 Open the media slot cover.
- 2 Put the memory card or USB Flash drive in the correct slot.
- 3 Press **Photo**.
- 4 Press ◀ or ▶ to display **View Photos**.
- 5 Press **View Photos**.
- 6 Press ◀ or ▶ to display each photo. When the photo you want is displayed, press it, and then press **OK**.
- 7 Press **OK**.
- 8 Press **Print Settings**.
- 9 Press ▲ or ▼ to display **Auto Correct**.
- 10 Press **Auto Correct**.
- 11 Press **On (or Off)**.
- 12 If you do not want to change additional settings, press  or **OK**.
Press **Start** to print.

Adjusting Brightness, Contrast and Colour

Brightness

- 1 Open the media slot cover.
- 2 Put the memory card or USB Flash drive in the correct slot.
- 3 Press **Photo**.
- 4 Press **◀** or **▶** to display **View Photos**.
- 5 Press **View Photos**.
- 6 Press **◀** or **▶** to display each photo. When the photo you want is displayed, press it, and then press **OK**.
- 7 Press **OK**.
- 8 Press **Print Settings**.
- 9 Press **▲** or **▼** to display **Brightness**.
- 10 Press **Brightness**.
- 11 Adjust the level of brightness by pressing it on the Touchscreen.
- 12 If you do not want to change additional settings, press **↩** or **OK**. Press **Start** to print.

Contrast

You can choose the contrast setting. Increasing the contrast will make an image look sharper and more vivid.

- 1 Open the media slot cover.
- 2 Put the memory card or USB Flash drive in the correct slot.
- 3 Press **Photo**.
- 4 Press **◀** or **▶** to display **View Photos**.
- 5 Press **View Photos**.
- 6 Press **◀** or **▶** to display each photo. When the photo you want is displayed, press it, and then press **OK**.
- 7 Press **OK**.
- 8 Press **Print Settings**.
- 9 Press **▲** or **▼** to display **Contrast**.
- 10 Press **Contrast**.
- 11 Adjust the level of contrast by pressing it on the Touchscreen.
- 12 If you do not want to change additional settings, press **↩** or **OK**. Press **Start** to print.

Colour Enhancement

You can turn on the colour enhancement feature to print more vivid images. Printing time will be slower with this feature and also, depending on the image you are printing, it may use more ink.

- 1 Open the media slot cover.
- 2 Put the memory card or USB Flash drive in the correct slot.
- 3 Press **Photo**.
- 4 Press ◀ or ▶ to display **View Photos**.
- 5 Press **View Photos**.
- 6 Press ◀ or ▶ to display each photo. When the photo you want is displayed, press it, and then press **OK**.
- 7 Press **OK**.
- 8 Press **Print Settings**.
- 9 Press ▲ or ▼ to display **Colour Enhance**.
- 10 Press **Colour Enhance**.
- 11 Do one of the following:
 - If you want to customize the **White Balance**, **Sharpness** or **Colour Density**, press **Colour Enhance**, and then press **On**.
Go to step 12.
 - If you do not want to customize, press **Colour Enhance**, and then press **Off**.
Press **↩**.
Go to step 15.
- 12 Press ▲ or ▼ to display **White Balance**, **Sharpness** or **Colour Density**, and then press the option you want.

- 13 Press ◀ or ▶ to adjust the degree of the setting.
Press **OK**.
- 14 Do one of the following:
 - If you want to customize another colour enhancement, repeat steps 12 and 13.
Press **↩**.
 - If you want to change other settings, press **↩** to display the print setting menu and press the setting you want to change. (See *PhotoCapture Center™ print settings* on page 59.)
- 15 If you do not want to change additional settings, press **↩** or **OK**.
Press **Start** to print.

NOTE

• White Balance

This setting adjusts the hue of the white areas of an image. Lighting, camera settings and other influences will affect the appearance of white. The white areas of a picture may be slightly pink, yellow or some other colour. By using this setting, you can correct that effect and bring the white areas back to pure white.

• Sharpness

This setting enhances the detail of an image, similar to adjusting the fine focus on a camera. If the image is not in true focus and you cannot see the fine details of the picture, then adjust the sharpness.

• Colour Density

This setting adjusts the total amount of colour in the image. You can increase or decrease the amount of colour in an image to improve a washed-out or weak picture.

Cropping

If your photo is too long or too wide to fit the available space on your chosen layout, part of the image will be cropped.

The default setting is **On**. If you want to print the whole image, change this setting to **Off**. If you set **Cropping** to **Off**, also set **Borderless** to **Off**. (See *Borderless printing* on page 64.)

- 1 Open the media slot cover.
- 2 Put the memory card or USB Flash drive in the correct slot.
- 3 Press **Photo**.
- 4 Press **◀** or **▶** to display **View Photos**.
- 5 Press **View Photos**.
- 6 Press **◀** or **▶** to display each photo. When the photo you want is displayed, press it, and then press **OK**.
- 7 Press **OK**.
- 8 Press **Print Settings**.
- 9 Press **▲** or **▼** to display **Cropping**.
- 10 Press **Cropping**.
- 11 Press **Off (or On)**.
- 12 If you do not want to change additional settings, press **↩** or **OK**. Press **Start** to print.

Cropping: On

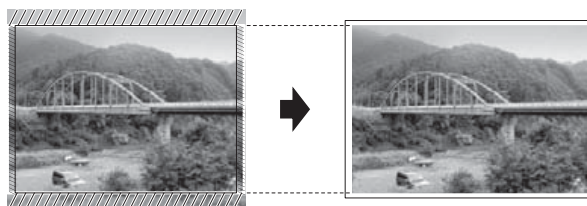

Cropping: Off

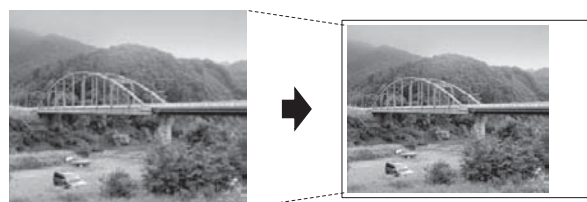

Borderless printing

This feature expands the printable area to the edges of the paper. Printing time will be slightly slower.

- 1 Open the media slot cover.
- 2 Put the memory card or USB Flash drive in the correct slot.
- 3 Press **Photo**.
- 4 Press **◀** or **▶** to display **View Photos**.
- 5 Press **View Photos**.
- 6 Press **◀** or **▶** to display each photo. When the photo you want is displayed, press it, and then press **OK**.
- 7 Press **OK**.
- 8 Press **Print Settings**.
- 9 Press **▲** or **▼** to display **Borderless**.
- 10 Press **Borderless**.
- 11 Press **Off (or On)**.
- 12 If you do not want to change additional settings, press **↩** or **OK**. Press **Start** to print.

Date Print

You can print the date if it is already in your photo's data. The date will be printed on the lower-right corner. If the data doesn't have the date information, you cannot use this function.

- 1 Open the media slot cover.
- 2 Put the memory card or USB Flash drive in the correct slot.
- 3 Press `Photo`.
- 4 Press ◀ or ▶ to display `View Photos`.
- 5 Press `View Photos`.
- 6 Press ◀ or ▶ to display each photo. When the photo you want is displayed, press it, and then press `OK`.
- 7 Press `OK`.
- 8 Press `Print Settings`.
- 9 Press ▲ or ▼ to display `Date Print`.
- 10 Press `Date Print`.
- 11 Press `On (or Off)`.
- 12 If you do not want to change additional settings, press  or `OK`. Press `Start` to print.

NOTE

The DPOF setting on your camera must be turned off to use the `Date Print` feature.

Setting your changes as a new default

You can save the print settings you use most often—such as `Print Quality`, `Paper Type`, `Paper Size`, `Print Size`, `Auto Correct`, `Brightness`, `Contrast`, `Colour Enhance`, `Cropping`, `Borderless` and `Date Print`—by setting them as the default settings. These settings will remain until you change them again.

- 1 Open the media slot cover.
- 2 Put the memory card or USB Flash drive in the correct slot.
- 3 Press `Photo`.
- 4 Press ◀ or ▶ to display `View Photos`.
- 5 Press `View Photos`.
- 6 Press ◀ or ▶ to display each photo. When the photo you want is displayed, press it, and then press `OK`.
- 7 Press `OK`.
- 8 Press `Print Settings`.
- 9 Press your new setting. Repeat this step for each setting you want to change.
- 10 After changing the last setting, press ▲ or ▼ to display `Set New Default`.
- 11 Press `Set New Default`.
- 12 The Touchscreen asks you to confirm the change to the new default settings. Press `Yes` to confirm.
- 13 Press .

Restoring all settings to the factory default

You can restore the PhotoCapture settings you have changed—such as Print Quality, Paper Type, Paper Size, Print Size, Auto Correct, Brightness, Contrast, Colour Enhance, Cropping, Borderless and Date Print—to the factory default.

- 1 Open the media slot cover.
- 2 Put the memory card or USB Flash drive in the correct slot.
- 3 Press **Photo**.
- 4 Press **◀** or **▶** to display **View Photos**.
- 5 Press **View Photos**.
- 6 Press **◀** or **▶** to display each photo. When the photo you want is displayed, press it, and then press **OK**.
- 7 Press **OK**.
- 8 Press **Print Settings**.
- 9 Press **▲** or **▼** to display **Factory Reset**.
- 10 Press **Factory Reset**.
- 11 The Touchscreen asks you to confirm to change back to the factory default. Press **Yes** to confirm.
- 12 Press **🏠**.

Scan to a memory card or USB Flash drive

Auto Crop

You can scan multiple documents placed on the scanner glass. An individual document can be previewed on the Touchscreen before you save it. When you choose **Auto Crop**, the machine will scan each document and create separate files. For example, if you place four documents on the scanner glass, the machine will scan and create four separate files. If you want to create a four-page file, choose **PDF** or **TIFF** for **File Type**.

(If you choose **JPEG**, the four documents are created as four separate files.)

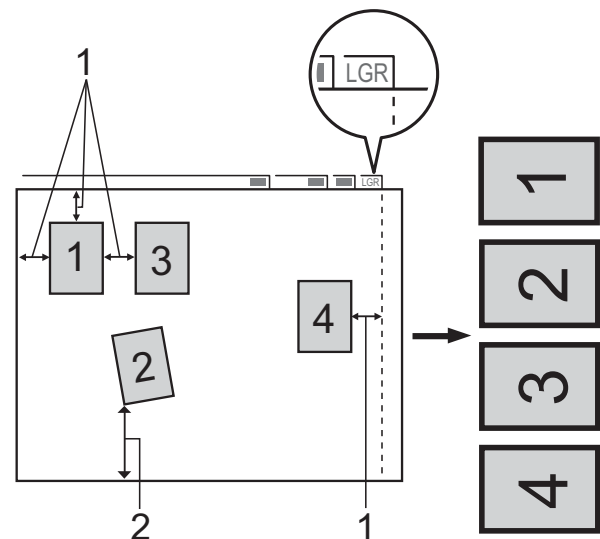

- 1 10 mm or greater (top, left, right)
- 2 20 mm or greater (bottom)

NOTE

Auto Crop is supported by technology from Reallusion, Inc.



- 1 Open the media slot cover.
- 2 Put the memory card or USB Flash drive in the correct slot.
- 3 Press `Scan to Media`.
- 4 Load your document.
- 5 Press `Options`.
- 6 Press `▲` or `▼` to display `Auto Crop`.
- 7 Press `Auto Crop`.
- 8 Press `On`.
- 9 Press `OK`.
- 10 If you do not want to change additional settings, press `Start` to start scanning.
- 11 The number of the scanned documents appears on the Touchscreen. Press `OK` to confirm.
- 12 Press `◀` or `▶` to preview the data for each document.
- 13 Press `Save All` to save the data.

NOTE

- `Auto Crop` is available for paper with 90-degree angles at all four corners. If one of the angles is not square, `Auto Crop` cannot detect the document.
- If your document is too long or wide, this setting does not work correctly. The document has to meet the following specification: up to 195 × 270 mm.

If the ratio between the height and width of the document is more than 1 to 8, this setting does not work correctly.

- You must place the documents away from the edges of the scanner glass as shown in the illustration.
- You must place the documents at least 10 mm apart from each other.
- `Auto Crop` adjusts the skew of the document on the scanner glass, but if your document is skewed more than 10 degrees, this setting will not work.
- The ADF must be empty to use `Auto Crop`.
- The `Auto Crop` feature is available for up to a maximum of 32 documents, depending on the documents' sizes.
- `ADF High Speed Mode` and `Scan Long Paper` are not available with `Auto Crop`.

IMPORTANT

DO NOT take out the memory card or USB Flash drive while the machine is reading or writing to the memory card or USB Flash drive to avoid damaging the card, USB Flash drive, or the data stored on them.

How to set a new default

You can save the Scan to Media settings—such as ADF High Speed Mode, Scan Type, Resolution, File Type, Scan Size, Scan Long Paper, Auto Crop and Remove Background Colour—by setting them as the default settings. These settings will remain until you change them again.

- 1 Open the media slot cover.
- 2 Put the memory card or USB Flash drive in the correct slot.
- 3 Press Scan to Media.
- 4 Press Options.
- 5 Press ▲ or ▼ to display ADF High Speed Mode, Scan Type, Resolution, File Type, Scan Size, Scan Long Paper, Auto Crop or Remove Background Colour, and then press the setting you want to change. Then press the option you want to set.

Repeat this step for each setting you want to change.

- 6 After you are finished choosing your preferred settings, press ▲ or ▼ to display Set New Default.
- 7 Press Set New Default.
- 8 The Touchscreen asks you to confirm the change to the new default settings. Press Yes to confirm.
- 9 Press .

How to reset to the factory default

You can restore all the Scan to Media settings that you have changed—such as ADF High Speed Mode, Scan Type, Resolution, File Type, Scan Size, Scan Long Paper, Auto Crop and Remove Background Colour—back to the factory default.

- 1 Open the media slot cover.
- 2 Put the memory card or USB Flash drive in the correct slot.
- 3 Press Scan to Media.
- 4 Press Options.
- 5 Press ▲ or ▼ to display Factory Reset.
- 6 Press Factory Reset.
- 7 The Touchscreen asks you to confirm to change back to the factory default. Press Yes to confirm.
- 8 Press .

Saving scan options as a Shortcut

You can store the scan options you use frequently by saving them as a Shortcut. This section introduces how to add a Shortcut for Scan to Media.

- 1 Open the media slot cover.
- 2 Put the memory card or USB Flash drive in the correct slot.
- 3 Press `Scan to Media`.
- 4 Press `Options`.
- 5 Press `▲` or `▼` to display ADF High Speed Mode, Scan Type, Resolution, File Type, Scan Size, Scan Long Paper, File Name, Auto Crop or Remove Background Colour, and then press the setting you want to change. Then press the option you want to set.

Repeat this step for each setting you want to change.

- 6 When you have finished choosing new options, press `OK`.
- 7 Press `Save as Shortcut`.
- 8 Confirm the displayed list of settings you have chosen for the Shortcut, and then press `OK`.
- 9 Enter a name for the Shortcut using the keyboard on the Touchscreen. (For help entering letters, see Basic User's Guide: *Entering Text*.) Press `OK`.
- 10 Press `OK` to save your Shortcut.

Printing photos directly from a PictBridge camera



Your Brother machine supports the PictBridge standard, allowing you to connect to and print photos directly from any PictBridge compatible digital camera.

If your camera is using the USB Mass Storage standard, you can also print photos from a digital camera without PictBridge. (See *Printing photos directly from a digital camera (without PictBridge)* on page 72.)

PictBridge requirements

To avoid errors, remember the following points:

- The machine and the digital camera must be connected using a suitable USB cable.
- The image file extension must be .JPG (other image file extensions like .JPEG, .TIF, .GIF and so on will not be recognized).
- PhotoCapture Center™ operations are not available when using the PictBridge feature.

Setting your digital camera

Make sure your camera is in PictBridge mode. The following PictBridge settings may be available from the LCD of your PictBridge compatible camera.

Depending on your camera, some of these settings may not be available.

Camera Menu Selections	Options
Paper Size	A3, A4, Ledger, Letter, 10 × 15 cm, Printer Settings (Default setting) ²
Paper Type	Plain Paper, Glossy Paper, Inkjet Paper, Printer Settings (Default setting) ²
Layout	Borderless: On, Borderless: Off, Printer Settings (Default setting) ²
DPOF Setting ¹	-
Print Quality	Normal, Fine, Printer Settings (Default setting) ²
Colour Enhancement	On, Off, Printer Settings (Default setting) ²
Date Print	On, Off, Printer Settings (Default setting) ²

¹ See *DPOF printing* on page 72 for more details.

² If your camera is set to use the Printer Settings (Default setting), the machine will print your photo using the settings in the table.

Settings	Options
Paper Size	10 × 15 cm
Paper Type	Other Glossy
Layout	Borderless: On
Print Quality	Photo
Colour Enhancement	Off
Date Print	Off

- When your camera does not have any menu selections, these settings are also used.
- The name and availability of each setting depends on your camera's specifications.

Please refer to the documentation supplied with your camera for more detailed information on changing PictBridge settings.

Printing Images

NOTE

Remove any memory card or USB Flash drive from the machine before connecting a digital camera.

- 1 Open the media slot cover.
- 2 Make sure that your camera is turned off. Connect your camera to the USB direct interface (1) on the machine using the USB cable.

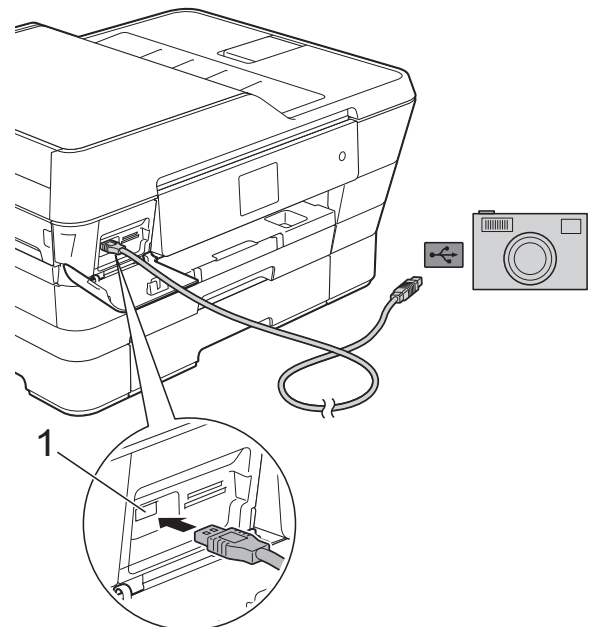

1 USB direct interface

- 3 Turn on the camera. When the machine has recognized the camera, the Touchscreen shows *Camera is connected*.
- 4 Choose the photo you want to print following the instructions from your camera. When the machine starts printing a photo, the Touchscreen will show *Printing*.

IMPORTANT

To prevent damage to your machine, do not connect any device other than a digital camera or USB Flash drive to the USB direct interface.

DPOF printing

DPOF stands for Digital Print Order Format.

Major digital camera manufacturers (Canon Inc., Eastman Kodak Company, FUJIFILM Corporation, Panasonic Corporation and Sony Corporation) created this standard to make it easier to print images from a digital camera.

If your digital camera supports DPOF printing, you can choose the images and number of copies you want to print from the camera's display.

NOTE

A DPOF File error can occur if the print order that was created on the camera has been corrupted. Delete and recreate the print order using your camera to correct this problem. For instructions on how to delete or recreate the print order, refer to your camera manufacturer's support website or accompanying documentation.

Printing photos directly from a digital camera (without PictBridge)

If your camera supports the USB Mass Storage standard, you can connect your camera in storage mode. This enables you to print photos from your camera.

(If you would like to print photos in PictBridge mode, see *Printing photos directly from a PictBridge camera* on page 70.)

NOTE

The name, availability and operation differ among digital cameras. Please refer to the documentation supplied with your camera for detailed information, such as how to switch from PictBridge mode to USB mass storage mode.

Printing Images

NOTE

Remove any memory card or USB Flash drive from the machine before connecting a digital camera.

- 1 Open the media slot cover.
- 2 Make sure that your camera is turned off. Connect your camera to the USB direct interface (1) on the machine using the USB cable.

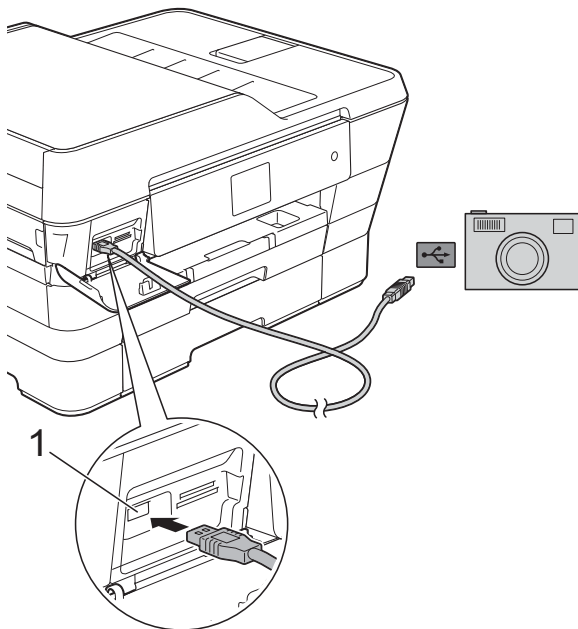

1 USB direct interface

- 3 Turn on the camera.
- 4 Follow the steps in *Print Images* on page 54.

IMPORTANT

To prevent damage to your machine, do not connect any device other than a digital camera or USB Flash drive to the USB direct interface.

A

Routine maintenance

Cleaning and checking the machine

Cleaning the outside of the machine

Clean the Touchscreen as follows:

IMPORTANT

- Press and hold down  to turn the machine off. The Touchscreen will show *Shutting Down* for a few seconds before the power goes off.
- DO NOT use any type of liquid cleaners (including ethanol).

- 1 Clean the Touchscreen with a soft, *dry*, lint-free cloth.

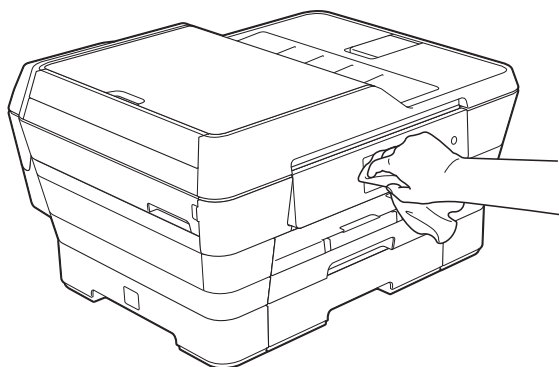

Clean the outside of the machine as follows:

IMPORTANT

- Use neutral detergents. Cleaning with volatile liquids, such as thinner or benzine, will damage the outside surface of the machine.
- DO NOT use cleaning materials that contain ammonia.
- DO NOT use isopropyl alcohol to remove dirt from the control panel. It may crack the panel.

- 1 (MFC-J3520/MFC-J6520DW)
Pull the paper tray #1 (1) completely out of the machine.

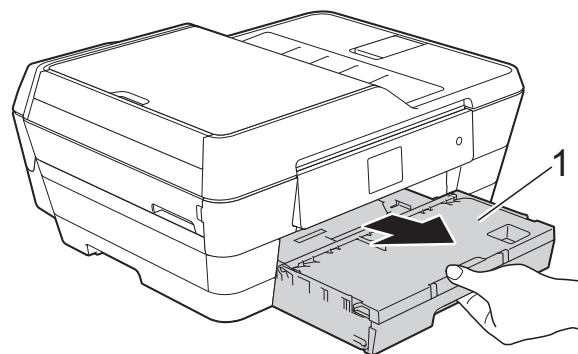

- (MFC-J3720/MFC-J6720DW)
Pull the paper tray #1 (1) and then tray #2 (2) completely out of the machine.

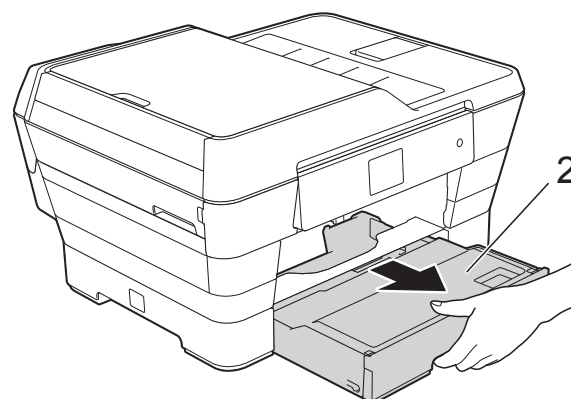
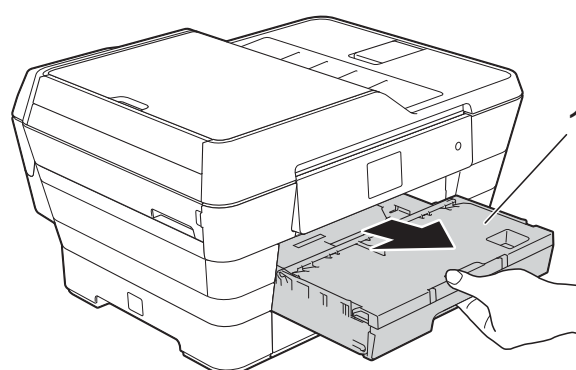

- Wipe the outside of the machine with a soft, *dry*, lint-free cloth to remove dust.

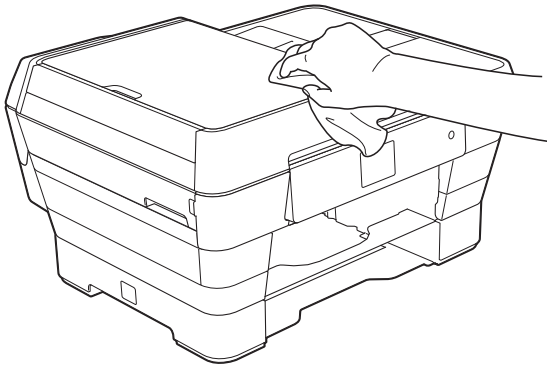

- Lift the output paper tray cover and remove anything that is stuck inside the paper tray.
- Wipe the inside and outside of the paper tray with a soft, *dry*, lint-free cloth to remove dust.

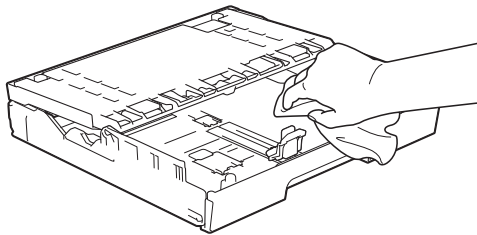

- Close the output paper tray cover and put the paper tray firmly back in the machine.

Cleaning the machine's printer platen

! WARNING



Be sure to unplug the machine from the electrical socket before cleaning the printer platen to avoid an electrical shock.

- Using both hands, use the finger holds on each side of the machine to lift the scanner cover into the open position.
- Clean the machine's printer platen (1) and the area around it, wiping off any scattered ink with a soft, *dry*, lint-free cloth.

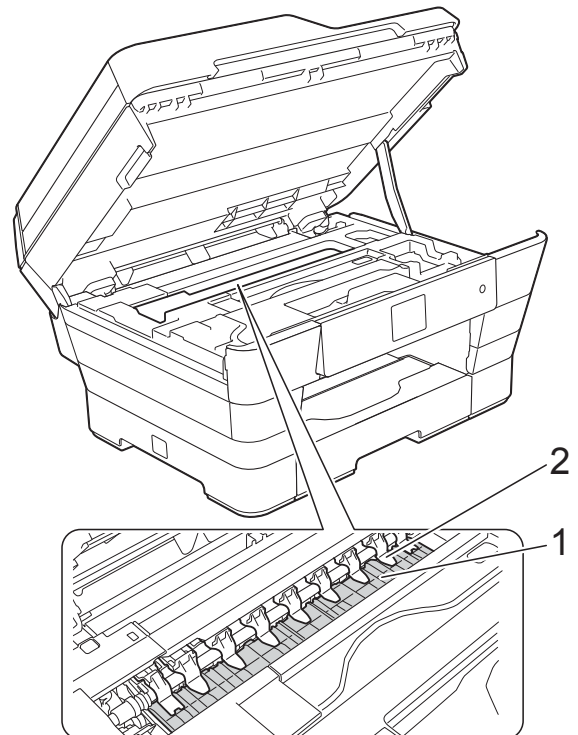

IMPORTANT

DO NOT bend or apply too much pressure on the nine tabs (2). They could be damaged.

- 3 Gently close the scanner cover using the finger holds on each side.

⚠ CAUTION

Be careful not to pinch your fingers when you close the scanner cover.

Always use the finger holds provided on each side of the scanner cover when opening and closing it.

- 4 Re-connect the power cord.

Cleaning the paper feed rollers

If the paper feed rollers are stained with ink, it may cause paper feed problems.

- 1 Unplug the machine from the electrical socket. Pull the paper tray (1) completely out of the machine.

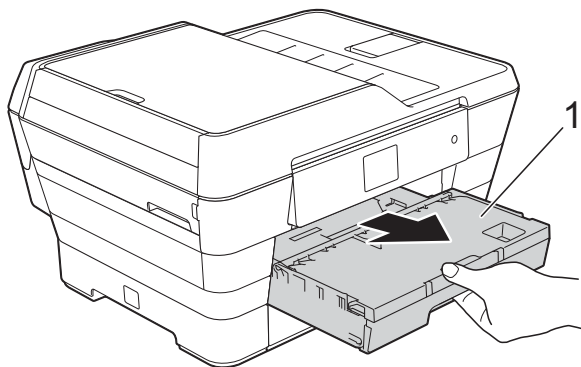

NOTE

If the paper support flap is open, close it, and then close the paper support.

- 2 Clean the front side of the Paper Feed Rollers (1) with a soft lint-free cloth slightly moistened with water, using a side-to-side motion.

After cleaning, wipe the rollers with a soft, *dry*, lint-free cloth to remove all moisture.

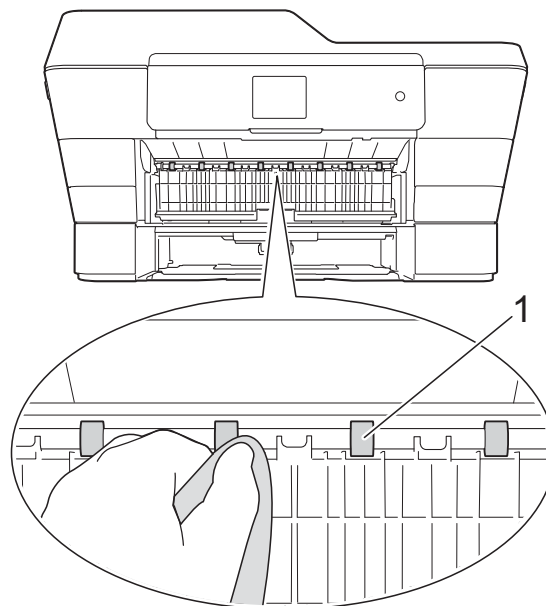

- 3 Lift the green Jam Clear Flap (2), and then clean the back side of the Paper Feed Rollers (1) with a soft lint-free cloth slightly moistened with water.

After cleaning, wipe the rollers with a soft, *dry*, lint-free cloth to remove all moisture.

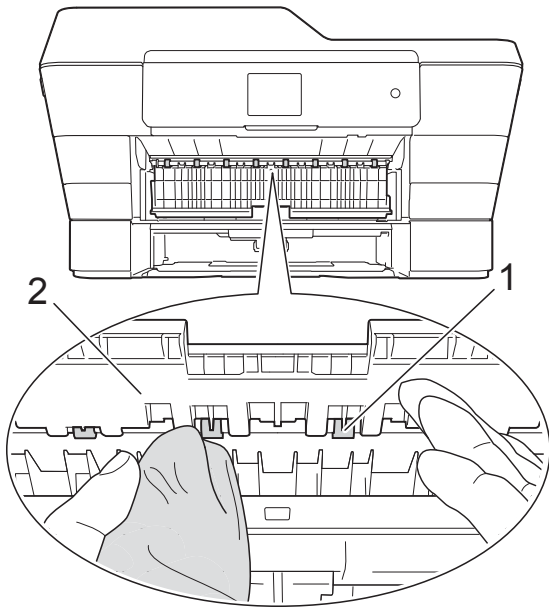

- 4 Put the paper tray firmly back in the machine.
- 5 Re-connect the power cord.

NOTE

Do not use the machine again until the rollers are completely dry. Using the machine before the rollers are dry may cause paper feed problems.

Cleaning the paper pick-up rollers

- 1 Unplug the machine from the electrical socket.
- 2 Pull the paper tray completely out of the machine.

NOTE

If the machine has been feeding multiple pages when there are only a few sheets of paper left in the tray, clean the Base Pad (1) with a soft lint-free cloth slightly moistened with water.

After cleaning, wipe the pad with a soft, *dry*, lint-free cloth to remove all moisture.

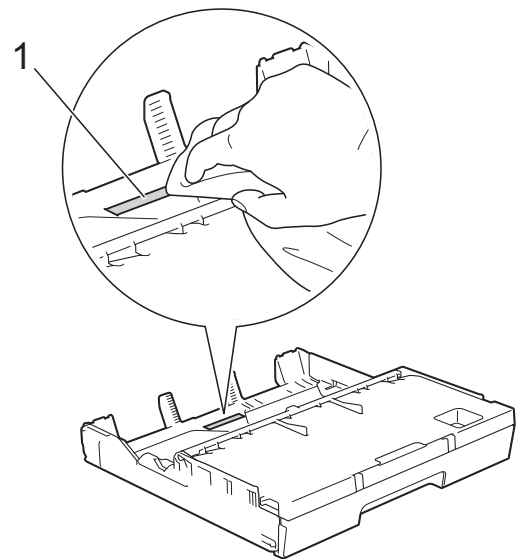

- 3 Lift the green Jam Clear Flap (1), and then clean the Paper Pick-up Rollers (2) with a soft lint-free cloth slightly moistened with water. Slowly turn the rollers so that the whole surface is cleaned.

After cleaning, wipe the rollers with a soft, *dry*, lint-free cloth to remove all moisture.

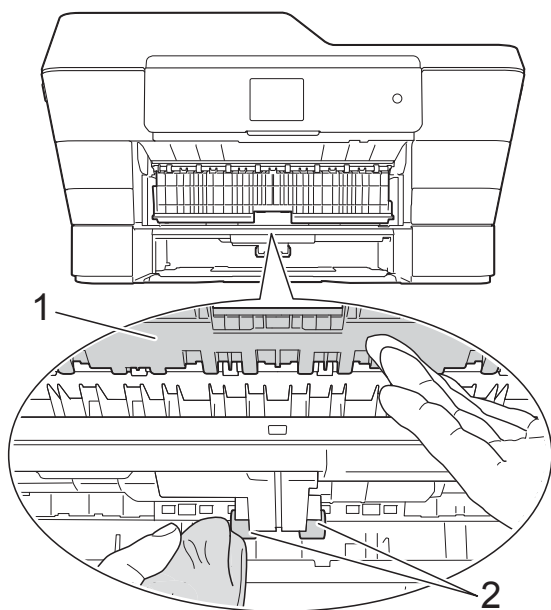

- 4 Put the paper tray firmly back in the machine.
- 5 Re-connect the power cord.

Cleaning the paper pick-up rollers for paper tray #2 (MFC-J3720/MFC-J6720DW)

- 1 Unplug the machine from the AC power outlet. Pull tray #2 completely out of the machine.

NOTE

If the paper support flap is open, close it, and then close the paper support.

- 2 Clean the paper pick-up rollers for tray #2 (1) with a soft lint-free cloth moistened with water. Slowly turn the rollers so that the whole surface is cleaned.

After cleaning, wipe the rollers with a soft, *dry*, lint-free cloth to remove all moisture.

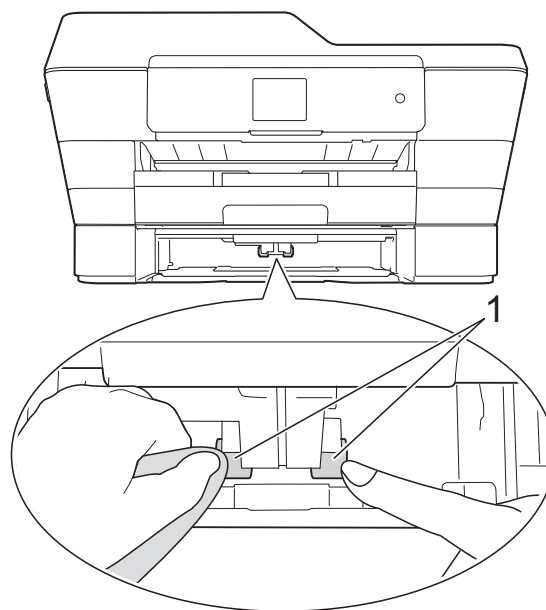

- 3 Put tray #2 firmly back in the machine.
- 4 Re-connect the power cord.

Checking the ink volume

Although an ink volume icon appears on the Touchscreen, you can use the ink menu to see a large graph showing the amount of ink that is left in each cartridge.

- 1 Press .

NOTE

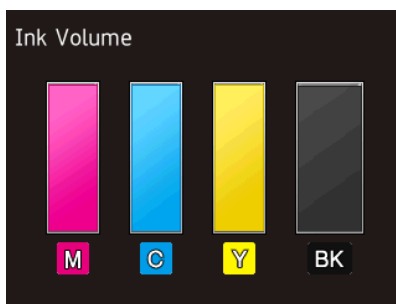

You can also press  (Settings) and Ink.

- 2 Press Ink Volume.
The Touchscreen shows the ink volume.



NOTE

When the ink cartridge is near the end of its life or having a problem, one of the following icons is displayed.

	The ink level is low.
	The ink cartridge is at the end of its life.
	There is a problem with the ink cartridge.

- 3 Press .

NOTE

You can check the ink volume from your computer.

(See Software and Network User's Guide.)

Packing and shipping the machine

When you transport the machine, use the packing materials that came with your machine. Follow the instructions below to correctly package your machine. Damage caused to your machine during transit may not be covered by your warranty.

The machine should be adequately insured with the carrier.

IMPORTANT

It is important to allow the machine to “park” the print head after a print job. Listen carefully to the machine before unplugging it to make sure that all mechanical noises have stopped and the print head is in the right corner as shown in the illustration. Not allowing the machine to finish this parking process may lead to print problems and possible damage to the print head.

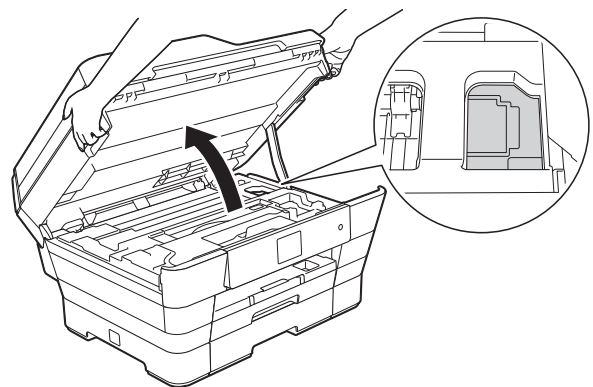

- 1 Unplug the machine from the electrical socket.
- 2 Using both hands, use the finger holds on each side of the machine to lift the scanner cover into the open position. Then unplug the machine from the telephone wall socket and take the telephone line cord out of the machine.
- 3 Unplug the interface cable from the machine, if it is connected.

- 4 Remove the orange protective part from its storage place inside the right corner of the machine.

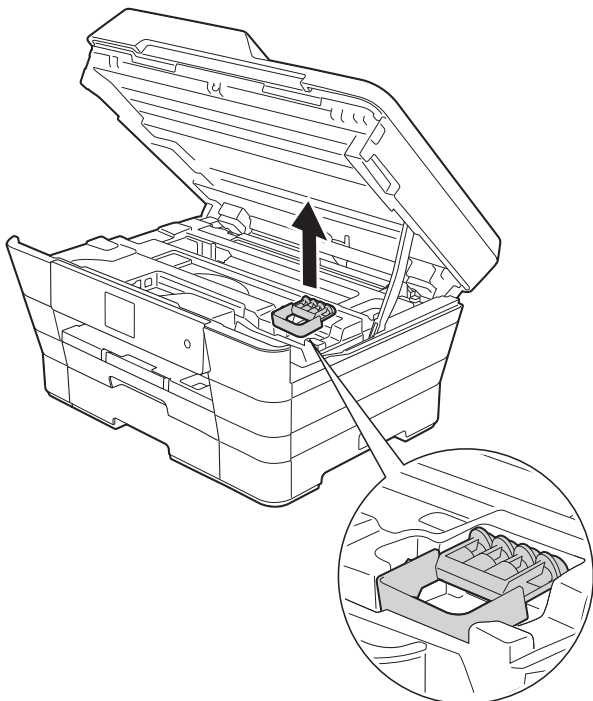

- 5 Gently close the scanner cover using the finger holds on each side.

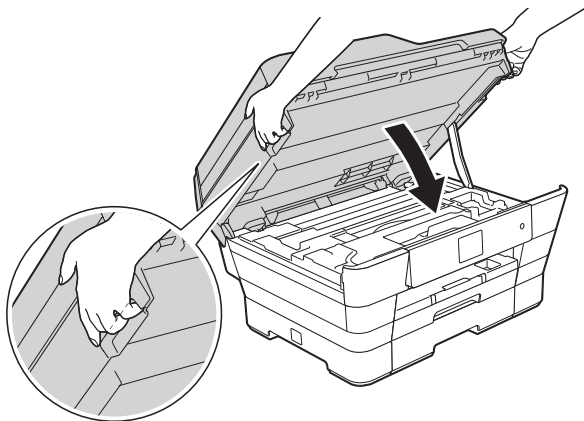

⚠ CAUTION

Be careful not to pinch your fingers when you close the scanner cover.

Always use the finger holds provided on each side of the scanner cover when opening and closing it.

- 6 Open the ink cartridge cover.
- 7 Remove all four ink cartridges. Press the ink release lever above each cartridge to release it. (See Basic User's Guide: *Replacing the ink cartridges.*)
- 8 Install the orange protective part, and then close the ink cartridge cover.

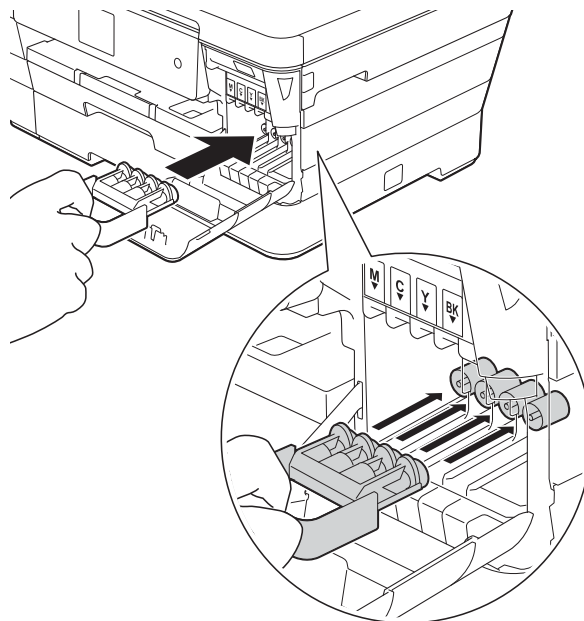

IMPORTANT

- Make sure the plastic tab on the left side of the orange protective part (1) locks securely into place (2).

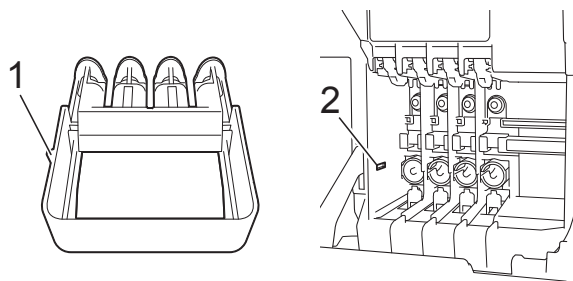

- If you cannot find the orange protective part, ship the machine without it. **DO NOT** install the ink cartridges as an alternative before shipping.

- 9 Wrap the machine in the bag.

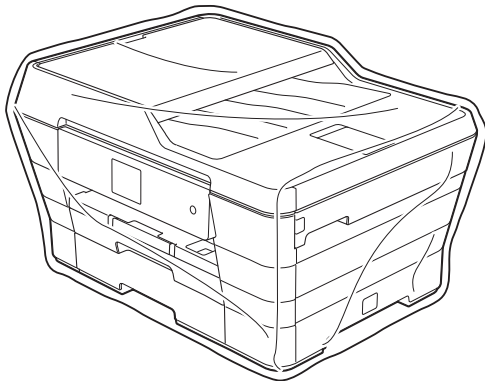

- 10 Pack the machine and the printed materials in the original carton with the original packing material as shown below.
Do not pack the used ink cartridges in the carton.

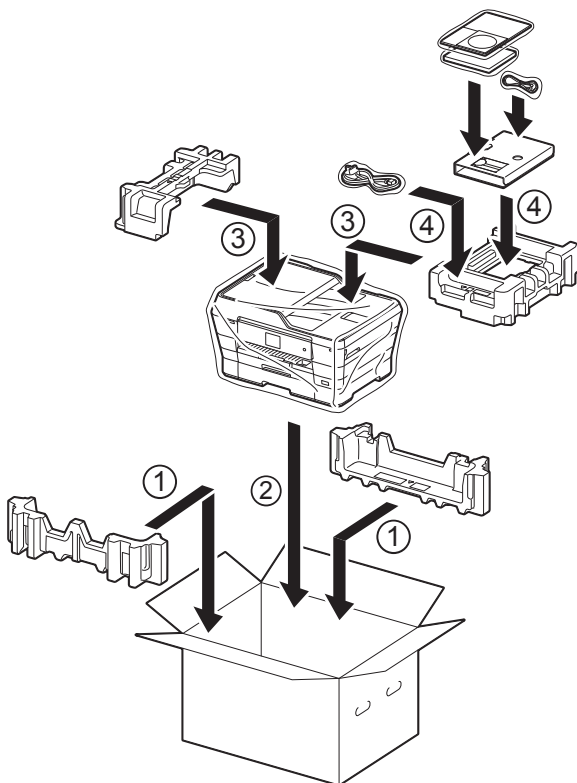

- 11 Close the carton and tape it shut.

B

Glossary

This is a comprehensive list of features and terms that appear in Brother manuals. Availability of these features depends on the model you purchased.

2.7"(67.5 mm) Touchscreen LCD and Touchpanel

The Touchscreen LCD (Liquid Crystal Display) on the machine shows interactive messages and prompts for using the machine. You can operate the Touchscreen by pressing or swiping on the screen.

The Touchpanel, on the right side of the Touchscreen LCD, illuminates its LEDs when they are available for the current operation.

Address Book

Names and numbers you have stored for easy dialling.

Address Book List

A listing of names and numbers stored in the Address Book memory, in alphabetical order.

ADF (automatic document feeder)

The document can be placed in the ADF and scanned one page at a time automatically.

Auto Reduction

Reduces the size of incoming faxes.

Automatic fax transmission

Sending a fax without picking up the handset of an external telephone.

Automatic Redial

A feature that enables your machine to redial the last fax number after five minutes if the fax did not go through because the line was busy.

Backup Print

Your machine prints a copy of every fax that is received and stored in its memory. This is a safety feature so you will not lose messages during a power failure.

Batch Transmission

(Monochrome faxes only) As a cost-saving feature, all delayed faxes to the same fax number can be sent as one transmission.

Beep Volume

Volume setting for the beep when you press the Touchscreen or Touchpanel, make an error.

Brightness

Changing the Brightness makes the whole image lighter or darker.

Broadcasting

The ability to send the same fax message to more than one location.

Caller ID (Only available for some countries)

A service purchased from the telephone company that lets you see the number (or name) of the party calling you.

CNG tones

The special tones (beeps) sent by fax machines during automatic transmission to tell the receiving machine that a fax machine is calling.

Coding method

Method of coding the information contained in the document. All fax machines must use a minimum standard of Modified Huffman (MH). Your machine is capable of greater compression methods, Modified Read (MR), Modified Modified Read (MMR) and JPEG, if the receiving machine has the same capability.

Colour Enhancement

Adjusts the colour in the image for better print quality by improving sharpness, white balance and colour density.

Communication error (Comm. Error)

An error during fax sending or receiving, usually caused by line noise or static.

Compatibility group

The ability of one fax unit to communicate with another. Compatibility is assured between ITU-T Groups.

Contrast

Setting to compensate for dark or light documents, by making faxes or copies of dark documents lighter and light documents darker.

Delayed Fax

Sends your fax at a specified time later.

Density

Changing the Density makes the whole image lighter or darker.

Distinctive Ring (For Australia, Singapore and Hong Kong)

A subscriber service purchased from the telephone company that gives you another telephone number on an existing telephone line. The Brother machine uses the new number to simulate a dedicated fax line.

Dual Access

Your machine can scan outgoing faxes or scheduled jobs into the memory at the same time it is sending a fax from memory, receiving or printing an incoming fax.

ECM (Error Correction Mode)

Detects errors during fax transmission and resends the pages of the fax that had an error.

Extension telephone

A telephone using the same line as your fax but plugged into a separate wall socket.

External telephone

A TAD (telephone answering device) or telephone that is connected to your machine.

F/T Ring Time

The length of time that the Brother machine rings (when the Receive Mode setting is Fax/Tel) to notify you to pick up a voice call that it answered.

FaxAbility (New Zealand only)

A subscriber service purchased from the telephone company that provides another phone number on an existing phone line. The Brother fax machine uses the new number to simulate a dedicated fax line.

Fax Detect

Enables your machine to respond to CNG tones if you interrupt a fax call by answering it.

Fax Forwarding

Sends a fax received into the memory to another pre-programmed fax number.

Fax Journal

Lists information about the last 200 incoming and outgoing faxes. TX means Transmit. RX means Receive.

Fax Storage

You can store received faxes in memory.

Fax tones

The signals sent by sending and receiving fax machines while communicating information.

Fax/Tel

You can receive faxes and telephone calls. Do not use this mode if you are using a telephone answering device (TAD).

Fine resolution

Resolution is 203 × 196 dpi. It is used for small print and graphs.

Greyscale

The shades of grey available for copying, scanning and faxing photographs.

Group number

A combination of Address Book numbers that are stored in Address Book for Broadcasting.

Innobella™

Innobella™ is a range of genuine consumables offered by Brother. For best quality results, Brother recommends Innobella™ ink and paper.

Journal Period

The pre-programmed time period between automatically printed Fax Journal reports. You can print the Fax Journal report on demand without interrupting the cycle.

Manual fax

(Not available in South Africa)
You can press **Hook** to hear the receiving fax machine answer before you press **Fax Start** to begin sending the fax.
(For South Africa only)
When you lift the handset of your external telephone you can hear the receiving fax machine answer before you press **Fax Start** to begin sending the fax.

Memory Receive

Receives faxes into the machine's memory when the machine is out of paper.

OCR (optical character recognition)

Nuance™ PaperPort™ 12SE or Presto! PageManager software application converts an image of text to text you can edit.

Overseas Mode

Makes temporary changes to the fax tones to accommodate noise and static on overseas telephone lines.

Pause

Allows you to place a 3.5 second delay in the dialling sequence while you are dialling using the dial pad or while you are storing Address Book numbers. Press **Pause** on the Touchscreen as many times as needed for longer pauses.

PhotoCapture Center™

Allows you to print digital photos from your digital camera at high resolution for photo quality printing.

Photo resolution (Mono only)

A resolution setting that uses varying shades of grey for the best representation of photographs.

PictBridge

Allows you to print photos directly from your digital camera at high resolution for photo quality printing.

Polling

The process of a fax machine calling another fax machine to retrieve waiting fax messages.

Pulse (Not available in New Zealand)

A form of rotary dialling on a telephone line.

Real Time Transmission

When the memory is full, you can send faxes in real time.

Remaining jobs

You can check which jobs are waiting in memory and cancel jobs individually.

Remote Access Code

Your own four-digit code (---*) that allows you to call and access your machine from a remote location.

Remote Activation Code

Press this code (* 5 1 (* 9 1 for New Zealand)) when you answer a fax call on an extension or external telephone.

Remote Deactivation Code (For Fax/Tel mode only)

When the machine answers a voice call, it fast double-rings. You can pick up at an extension telephone by pressing this code (# 5 1 (# 9 1 for New Zealand)).

Remote Retrieval Access

The ability to access your machine remotely from a touch-tone telephone.

Resolution

The number of vertical and horizontal lines per inch. (See Standard resolution, Fine resolution, Super Fine resolution and Photo resolution.)

Ring Delay

The number of rings before the machine answers in **Fax Only** and **Fax/Tel** modes.

Ring Volume

Volume setting for the machine's ring.

Scanning

The process of sending an electronic image of a paper document to your computer.

Scan to Media

You can scan a monochrome or colour document onto a memory card or USB Flash drive. Monochrome images will be in the TIFF or PDF file format and colour images may be in the PDF or JPEG file format.

Search

An alphabetical electronic listing of stored Address Book and Group numbers.

Settings Tables

At-a-glance instructions that show all the settings and options that are available for setting up your machine.

Standard resolution

203 × 98 dpi (monochrome).
203 × 196 dpi (colour). It is used for regular sized text and the quickest transmission.

Station ID

The stored information that appears on the top of faxed pages. It includes the sender's name and fax number.

Super Fine resolution (Mono only)

203 × 392 dpi. Best for very small print and line art.

TAD (telephone answering device)

You can connect an external TAD to your machine.

Temporary settings

You can choose certain options for each fax transmission and copy without changing the default settings.

Tone (Not available in New Zealand)

A form of dialling on the telephone line used for touch-tone telephones.

Transmission

The process of sending faxes over the phone lines from your machine to the receiving fax machine.

Transmission Verification Report

A listing for each fax sent, that shows its date, time and number.

User Settings

A printed report that shows the current settings of the machine.

WLAN Report

A printed report that shows the result of the WLAN Connection.

C

Index

Numerics

- 2 in 1 ID Copy 42
- 2-sided
 - copy 48

A

- Access codes, storing and dialling 31
- Address Book
 - Broadcasting (Group dial) 15
 - changing Groups 33
 - deleting Groups 34
 - setting up Groups for Broadcasting ... 33
 - using Groups 15
 - setting up from Caller ID history 32
 - setting up from outgoing calls 32
- Apple Macintosh
 - See Software and Network User's Guide.

B

- Broadcasting 15
 - setting up Groups for 33

C

- Caller ID
 - Caller ID History report 36
- Cancelling
 - Fax Forwarding 22, 25
 - Fax Storage 22
 - jobs awaiting redial 19
- Cleaning
 - paper feed rollers 76
 - printer platen 75
- ControlCenter
 - See Software and Network User's Guide.
- Copy
 - 2 in 1 ID 42
 - 2-sided 48
 - A3 shortcut 51
 - book 46
 - density 43
 - enlarge/reduce 38
 - ink save mode 44
 - page layout (N in 1) 39

- poster 39
- quality 37
- remove background colour 47
- set new default 49
- sort 43
- thin paper 45
- using ADF 43
- Watermark 46
 - using a template 46

D

- Dialling
 - access codes and credit card numbers 31
 - dial prefix 4
 - Groups (Broadcasting) 15
 - restricting dialling 8
- Direct printing
 - from a non-PictBridge camera 72
 - from a PictBridge camera 70
- Dual Access 14

F

- Fax codes
 - changing 24
 - Remote Access Code 24
- Fax Forwarding
 - changing remotely 25, 26
 - programming a number 21
- Fax Storage 21
 - printing from memory 22
 - turning off 22
 - turning on 21
- Fax, from PC
 - See Software and Network User's Guide.
- Fax, stand-alone
 - receiving
 - at end of conversation 27
 - Fax Forwarding 25
 - into the memory 27
 - out of paper reception 27
 - printing from memory 22
 - reducing to fit on paper 27
 - retrieving from a remote site 25, 26

sending	10
at end of conversation	14
Broadcasting	15
cancelling from memory	19
contrast	11
delayed batch transmission	18
delayed fax	18
from memory (Dual Access)	14
manual	14
overseas	17
Real Time Transmission	17
Resolution	11
return to factory default	13
set new default	12
Function Lock	5

G

Groups for Broadcasting	33
-------------------------------	----

I

ID Copy	42
Ink cartridges	
checking ink volume	79

L

LCD (Liquid Crystal Display)	
Dim Timer	3
Language	3

M

Macintosh	
See Software and Network User's Guide.	
Manual	
transmission	14
Memory Storage	1
Movie printing	54

N

Network	
Printing	
See Software and Network User's Guide.	
Scanning	
See Software and Network User's Guide.	

Nuance™ PaperPort™ 12SE
 See Software and Network User's Guide.
 Also see Help in the PaperPort™ 12SE application.

P

Packing and shipping the machine	79
PhotoCapture Center™	
Adding Effect	55
DPOF printing	59
from PC	
See Software and Network User's Guide.	
ID photo	57
Photo Effects	
Auto Correct	55, 56
Crop	55, 56
Enhance Scenery	55, 56
Enhance Skin	55, 56
Fill Light	55, 56
Monochrome	55, 56
Night Scene	55, 56
Remove Red-Eye	55, 56
Sepia	55, 56
Whiteboard	55, 56
Print settings	
Borderless	64
Brightness	62
Colour enhancement	63
Contrast	62
Cropping	64
Date Print	65
Paper Size and Print Size	60
Paper Type	60
Quality	59
Return to factory default	66
rotate	56, 57
Set new default	65
Printing	
index	54
photos	55
Scan to Media	
auto crop	66
memory card	66
USB Flash drive	66
Slide-Show	58
PictBridge	70
DPOF Printing	72
Power failure	1

Presto! PageManager
 See Software and Network User's Guide.
 Also see Help in the Presto! PageManager application.

Print
 fax from memory22
 report36

Printing
 See Software and Network User's Guide.

R

Reducing
 copies38
 incoming faxes27

Remote Retrieval24
 commands25
 getting your faxes26
 Remote Access Code24

Remote Setup
 See Software and Network User's Guide.

Reports35
 Address Book36
 Caller ID history36
 Fax Journal36
 Journal Period35
 how to print36
 Network Configuration36
 Transmission Verification 35, 36
 User Settings36
 WLAN Report36

Resolution
 setting for next fax 11

Restricted users6

S

Scanning
 See Software and Network User's Guide.

Security
 Secure function lock
 administrator password6
 restricted users6

Shipping the machine79

Sleep Mode2

T

Troubleshooting
 checking ink volume79

W

Windows®
 See Software and Network User's Guide.

Wireless Network
 See Quick Setup Guide and Software and Network User's Guide.

brother®

Visit us on the World Wide Web
<http://www.brother.com/>

These machines are approved for use in the country of purchase only. Local Brother companies or their dealers will only support machines purchased in their own countries.



www.brotherearth.com

Free Manuals Download Website

<http://myh66.com>

<http://usermanuals.us>

<http://www.somanuals.com>

<http://www.4manuals.cc>

<http://www.manual-lib.com>

<http://www.404manual.com>

<http://www.luxmanual.com>

<http://aubethermostatmanual.com>

Golf course search by state

<http://golfingnear.com>

Email search by domain

<http://emailbydomain.com>

Auto manuals search

<http://auto.somanuals.com>

TV manuals search

<http://tv.somanuals.com>