

brother[®]

Advanced User's Guide

MFC-J2510
MFC-J4510DW

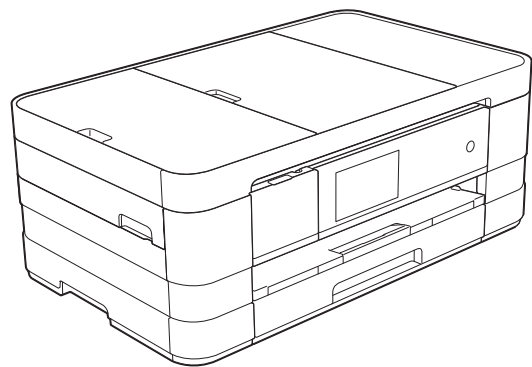

Version 0
ARL/ASA/NZ

User's Guides and where do I find them?

Which Guide?	What's in it?	Where is it?
Product Safety Guide	Read this Guide first. Please read the Safety Instructions before you set up your machine. See this Guide for trademarks and legal limitations.	Printed / In the box
Quick Setup Guide	Follow the instructions for setting up your machine and installing the drivers and software for the operating system and connection type you are using.	Printed / In the box
Basic User's Guide	Learn the basic Fax, Copy, Scan and PhotoCapture Center™ operations and how to replace consumables. See troubleshooting tips.	Printed / In the box
Advanced User's Guide	Learn more advanced operations: Fax, Copy, security features, printing reports and performing routine maintenance.	PDF file / CD-ROM
Software User's Guide	Follow these instructions for Printing, Scanning, Network Scanning, PhotoCapture Center™, Remote Setup, PC-Fax, Web Services (Scan), and using the Brother ControlCenter utility.	PDF file / CD-ROM
Network User's Guide	This Guide provides useful information about wired and wireless network settings and security settings using the Brother machine. You can also find supported protocol information for your machine and detailed troubleshooting tips.	PDF file / CD-ROM
Web Connect Guide	This Guide provides useful information about accessing Internet services from the Brother machine, as well as downloading images, printing data and uploading files directly to Internet services.	PDF file / Brother Solutions Center ¹
Google Cloud Print Guide	This Guide provides details on how to configure your Brother machine to a Google account and use Google Cloud Print™ services for printing over the Internet.	PDF file / Brother Solutions Center ¹
Wi-Fi Direct™ Guide	This Guide provides details on how to configure and use your Brother machine for wireless printing directly from a mobile device supporting the Wi-Fi Direct™ standard.	PDF file / Brother Solutions Center ¹
Mobile Print/Scan Guide for Brother iPrint&Scan	This Guide provides useful information about printing from your mobile device and scanning from your Brother machine to your mobile device when connected to a Wi-Fi network.	PDF file / Brother Solutions Center ¹

¹ Visit us at <http://solutions.brother.com/>.

Table of Contents

1	General setup	1
	Memory Storage	1
	Setting Daylight Saving Time.....	1
	Sleep Mode	2
	Touchscreen LCD.....	2
	Setting the Dim Timer for the backlight	2
	Dial Prefix	3
	Setting up or changing the prefix number.....	3
2	Security features	4
	Secure Function Lock 2.0.....	4
	Before you begin to use Secure Function Lock 2.0.....	4
	Setting and changing the Administrator Password.....	5
	Setting up restricted users.....	5
	Turning Secure Function Lock on/off.....	6
	Switching users	7
	Changing to the Public mode	7
	Restricting dialling.....	7
	Dial pad restriction.....	8
	Address Book restriction.....	8
	Shortcut restriction.....	8
	LDAP Server restriction	8
3	Sending a fax	9
	Additional sending options.....	9
	Sending faxes using multiple settings	9
	Stop faxing.....	9
	Contrast.....	10
	Changing fax resolution.....	10
	Setting your changes as a new default.....	11
	Restoring fax options to the factory default	12
	Saving fax options as a Shortcut	12
	Additional sending operations.....	13
	Sending a fax manually	13
	Sending a fax at the end of a conversation	13
	Dual Access (Monochrome only).....	13
	Broadcasting (Monochrome only).....	14
	Real Time Transmission.....	15
	Overseas Mode	16
	Delayed Faxing (Monochrome only).....	16
	Delayed Batch Transmission (Monochrome only).....	17
	Checking and cancelling waiting jobs	17
	Polling overview.....	18
	Polled Transmit (Monochrome only).....	18

4 Receiving a fax 20

Memory Receive (Monochrome only).....	20
Fax Forwarding.....	20
Fax Storage.....	20
Printing a fax from the memory.....	21
PC-Fax Receive (Windows® only).....	21
Turning off Memory Receive operations.....	22
Changing Memory Receive operations.....	23
Remote Retrieval.....	24
Setting a Remote Access Code.....	24
Using your Remote Access Code.....	24
Remote Fax commands.....	25
Retrieving fax messages.....	26
Changing your Fax Forwarding number.....	26
Additional receiving operations.....	27
Out of Paper Reception.....	27
Printing a reduced incoming fax.....	27
Receiving a fax at the end of a conversation.....	27
Fax recovery printing.....	28
Polling overview.....	29
Polling receive.....	29

5 Dialling and storing numbers 32

Additional dialling operations.....	32
Combining Address Book numbers.....	32
Additional ways to store numbers.....	33
Storing Address Book numbers from Outgoing Calls.....	33
Storing Address Book numbers from the Caller ID history.....	33
Setting up Groups for Broadcasting.....	34

6 Printing reports 36

Fax reports.....	36
Transmission Verification Report.....	36
Fax Journal (activity report).....	36
Reports.....	37
How to print a report.....	37

7 Making copies 38

Copy options.....	38
Stop copying.....	38
Changing copy speed and quality	38
Enlarging or reducing the copied image	39
Making N in 1 copies or a poster (Page Layout)	40
2 in 1 ID Copy (Page Layout)	41
Sorting copies using the ADF	42
Adjusting Density.....	42
Ink Save Mode.....	43
Thin Paper Copy.....	43
Book Copy	44
Watermark Copy.....	44
Remove Background Colour	45
2-sided copying	46
Saving copy options as a Shortcut	47
A3 Copy Shortcuts.....	48
A3 Copy Shortcut	48

8 Printing photos from a memory card or USB Flash memory drive 50

PhotoCapture Center™ operations	50
Memory cards, USB Flash memory drive and folder structures	50
Movie printing	51
Print Images.....	51
Print Index (Thumbnails)	51
Printing Photos	52
Enhance Photos	52
Slide Show.....	54
DPOF printing.....	55
PhotoCapture Center™ print settings.....	55
Print Quality	55
Paper options	56
Adjusting Brightness, Contrast and Colour.....	57
Cropping	59
Borderless printing.....	60
Date Print.....	60
Setting your changes as a new default.....	61
Restoring all settings to the factory default.....	61
Scan to a memory card or USB Flash memory drive	62
Auto Crop	62
How to set a new default	63
How to reset to the factory default.....	64
Saving scan options as a Shortcut	64

9	Printing photos from a camera	65
	Printing photos directly from a PictBridge camera	65
	PictBridge requirements	65
	Setting your digital camera	65
	Printing Images.....	66
	DPOF printing	67
	Printing photos directly from a digital camera (without PictBridge).....	67
	Printing Images.....	68
A	Routine maintenance	69
	Cleaning and checking the machine	69
	Cleaning the outside of the machine	69
	Cleaning the machine's printer platen	70
	Cleaning the paper feed rollers	71
	Cleaning the paper pick-up rollers	72
	Checking the ink volume	73
	Packing and shipping the machine	73
B	Glossary	76
C	Index	80

Memory Storage

Your menu settings are stored permanently, and, in the event of a power failure, will not be lost. Temporary settings (for example, `Overseas Mode`) will be lost. If you have chosen `Set New Default` for your `Fax`, `Scan` and `Photo` preferred settings, those settings will not be lost. Also, during a power failure, the machine will retain the date and time and programmed fax timer jobs (for example, `Delayed Fax`) for up to 24 hours.



Setting Daylight Saving Time

You can set the machine to change for daylight saving time. When selecting `Forward Hour` it will forward the time by an hour and backward one hour when selecting `Backward Hour`. Make sure you have set the correct date and time in the `Date & Time` setting.

- 1 Press .
- 2 Press .
- 3 Press `Daylight Save`.
- 4 Press `Forward Hour` OR `Backward Hour`.
- 5 Press .

Sleep Mode



You can choose how long the machine will remain idle before it goes into Sleep Mode (up to 60 minutes). The timer will restart if any operation is carried out on the machine.

- 1 Press .
- 2 Press All Settings.
- 3 Swipe up or down, or press ▲ or ▼ to display General Setup.
- 4 Press General Setup.
- 5 Swipe up or down, or press ▲ or ▼ to display Sleep Mode.
- 6 Press Sleep Mode.
- 7 Swipe up or down, or press ▲ or ▼ to display 1Min, 2Mins, 3Mins, 5Mins, 10Mins, 30Mins or 60Mins to choose the length of time the machine must be idle before entering Sleep Mode. Press the option you want to set.
- 8 Press .

Touchscreen LCD

Setting the Dim Timer for the backlight

You can set how long the LCD backlight stays on after the last finger press.

- 1 Press .
- 2 Press All Settings.
- 3 Swipe up or down, or press ▲ or ▼ to display General Setup.
- 4 Press General Setup.
- 5 Swipe up or down, or press ▲ or ▼ to display LCD Settings.
- 6 Press LCD Settings.
- 7 Press Dim Timer.
- 8 Press 10Secs, 20Secs, 30Secs or Off.
- 9 Press .

Dial Prefix

The Dial Prefix setting will automatically dial a predefined number before every fax number you dial. For example, if your telephone system requires a 9 to dial an outside number, use this setting to automatically dial 9 for every fax you send.

Setting up or changing the prefix number

- 1 Press .
- 2 Press All Settings.
- 3 Swipe up or down, or press ▲ or ▼ to display Initial Setup.
- 4 Press Initial Setup.
- 5 Swipe up or down, or press ▲ or ▼ to display Dial Prefix.
- 6 Press Dial Prefix.
- 7 Press On (or Off).
- 8 Press Dial Prefix.
- 9 Enter the prefix number (up to 5 digits) using the keyboard on the Touchscreen.
- 10 Press OK.

NOTE

- If your telephone system requires a timed break recall (hookflash), press ! on the Touchscreen.
 - You cannot use ! with any other numbers or characters.
 - If the pulse dialling mode is on, # and * are not available to use.
-

- 11 Press .

2

Security features

Secure Function Lock 2.0

Secure Function Lock lets you restrict public access to certain machine functions:

- Fax Tx (Fax Transmit)
- Fax Rx (Fax Receive)
- Copy
- Scan
- PCC (PhotoCapture Center™)
- PC Print
- Colour Print
- Page Limit
- Web Upload
- Web Download

This feature also prevents users from changing the default settings of the machine by limiting access to the menu settings.

Before using the security features, you must first enter an administrator password.

Access to restricted operations can be enabled by creating a restricted user.

Restricted users must enter a password to use the machine.

Make a careful note of your password. If you forget it, please contact Brother customer service for support.

NOTE

- Only administrators can set limitations and make changes for each user.
- If Fax Tx is disabled, you cannot use any functions in the Fax menu.
- Polled Transmit and Polling Receive are enabled only when both Fax Tx and Fax Rx are enabled.
- You cannot edit or delete a Shortcut when Secure Function Lock is set to on.

Before you begin to use Secure Function Lock 2.0

You can configure Secure Function Lock 2.0 settings using a Web browser. Before configuration, the following preparations are required.

- 1 Start your Web browser.
- 2 Type “http://machine’s IP address/” into your browser’s address bar (where “machine’s IP address” is the Brother machine’s IP address).

- For example:

`http://192.168.1.2/`

NOTE

You can find the machine's IP address on the Network Configuration Report. (See Network User’s Guide: *Printing the Network Configuration Report.*)

- 3 Enter a password in the **Login** box. (This is a password to log into the machine's Web page, not the administrator password for Secure Function Lock.) Click .

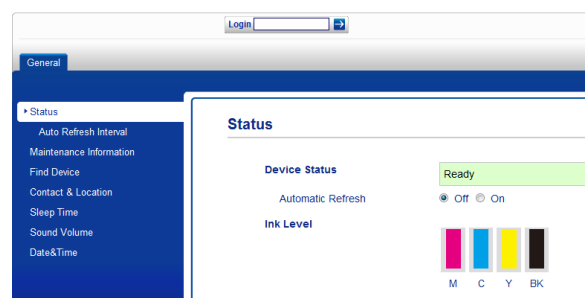

NOTE

If you are using a Web browser to configure the machine's settings for the first time, set a password.

- 1 Click **Please configure the password.**
- 2 Enter a password you want to use (up to 32 characters).
- 3 Re-enter the password in the **Confirm New Password** box.
- 4 Click **Submit.**

Setting and changing the Administrator Password

You can configure these settings using a Web browser. To set up the Web page, see *Before you begin to use Secure Function Lock 2.0* on page 4. Then follow the instructions below.

Setting the administrator password

The password you set in these steps is for the administrator. This password is used to set up users and to turn Secure Function Lock on or off. (See *Setting up restricted users* on page 5 and *Turning Secure Function Lock on/off* on page 6.)

- 1 Click **Administrator.**
- 2 Click **Secure Function Lock.**
- 3 Enter a four-digit number for the password in the **New Password** box.

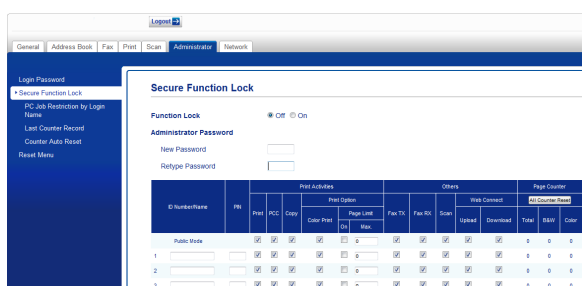

- 4 Re-enter the password in the **Retype Password** box.
- 5 Click **Submit.**

Changing the administrator password

- 1 Click **Administrator.**
- 2 Click **Secure Function Lock.**
- 3 Enter a four-digit number for the new password in the **New Password** box.
- 4 Re-enter the new password in the **Retype Password** box.
- 5 Click **Submit.**

Setting up restricted users

You can set up users with restrictions and a password. You can set up to 10 users.

You can configure these settings using a Web browser.

To set up the Web page, see *Before you begin to use Secure Function Lock 2.0* on page 4. Then follow the instructions below.

- 1 Click **Administrator.**
- 2 Click **Secure Function Lock.**
- 3 Enter an alphanumeric Group name or User name (up to 15 characters) in the **ID Number/Name** box and then enter a four-digit password in the **PIN** box.

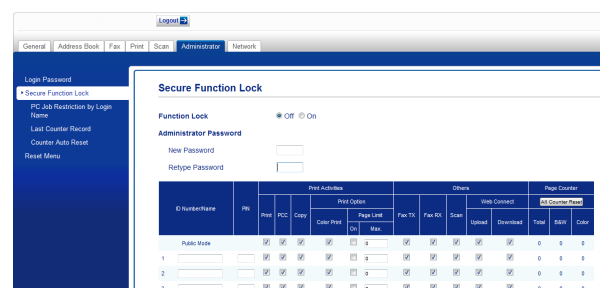

- 4 Uncheck the functions that you want to restrict in the **Print Activities** or **Others** boxes. If you want to configure the maximum page count, check the **On** box in **Page Limit**, and then enter the number in the **Max.** box. Click **Submit**.

NOTE

- You cannot use the same password as another user's password.
- You can set up one Public user. Public users do not need to enter a password. For more information, see Network User's Guide.

Turning Secure Function Lock on/off

NOTE

If you enter the wrong password, the Touchscreen will show **Wrong Password**. Enter the correct password. If you forget it, please contact Brother customer service for support.

Turning Secure Function Lock on

- 1 Press .
- 2 Press **All Settings**.
- 3 Swipe up or down, or press ▲ or ▼ to display **General Setup**.
- 4 Press **General Setup**.
- 5 Swipe up or down, or press ▲ or ▼ to display **Function Lock**.
- 6 Press **Function Lock**.
- 7 Press **Lock Off→On**.



- 8 Enter your four-digit administrator password using the keyboard on the Touchscreen. Press **OK**.

NOTE

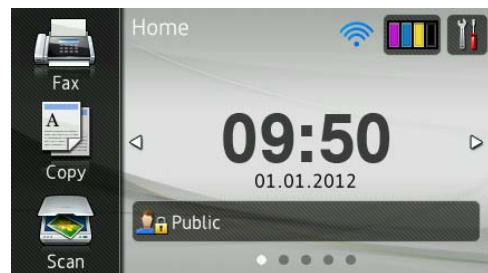
The Secure Function Lock icon is prominently displayed on the Home screen.





Turning Secure Function Lock off

- 1 Press  **Public** or  **XXXXX** (where xxxxx is the user's name).
- 2 Press **Lock On→Off**.
- 3 Enter your four-digit administrator password using the keyboard on the Touchscreen. Press **OK**.

Switching users

This setting allows a restricted user to log on to the machine when the Secure Function Lock is turned on.

- 1 On the Touchscreen, press  or  (where xxxxx is the user's name).
- 2 Press `Change User`.
- 3 Swipe up or down, or press `▲` or `▼` to display your user name.
- 4 Press your user name.
- 5 Enter your four-digit user password using the keyboard on the Touchscreen. Press `OK`.

Changing to the Public mode

- 1 Press  (where xxxxx is the user's name).
- 2 Press `Go to Public`.

Restricting dialling

This feature is to prevent users from sending a fax or call to a wrong number by mistake. You can set the machine to restrict dialling when you use the dial pad, Address Book, Shortcut and LDAP search.

If you choose `Off`, the machine does not restrict the dialling method.



If you choose `Enter # Twice`, the machine will prompt you to re-enter the number, and then if you re-enter the same number correctly, the machine will start dialling. If you re-enter the wrong number, the Touchscreen will show an error message.

If you choose `On`, the machine will restrict all fax sending and outbound calls for that dialling method.



NOTE

- The `Enter # Twice` setting will not work if you lift an external handset or press `Hook` before entering the number. You will not be asked to re-enter the number.
- If you chose `On` or `Enter # Twice`, you cannot use the `Broadcasting` feature.

Dial pad restriction

- 1 Press .
- 2 Press All Settings.
- 3 Swipe up or down, or press ▲ or ▼ to display Fax.
- 4 Press Fax.
- 5 Swipe up or down, or press ▲ or ▼ to display Dial Restriction.
- 6 Press Dial Restriction.
- 7 Press Dial Pad.
- 8 Press Enter # Twice, On or Off.
- 9 Press .



Address Book restriction

- 1 Press .
- 2 Press All Settings.
- 3 Swipe up or down, or press ▲ or ▼ to display Fax.
- 4 Press Fax.
- 5 Swipe up or down, or press ▲ or ▼ to display Dial Restriction.
- 6 Press Dial Restriction.
- 7 Press Address Book.
- 8 Press Enter # Twice, On or Off.
- 9 Press .



NOTE

If you combine Address Book numbers when dialling, the address will be recognized as Dial Pad input.

Shortcut restriction

- 1 Press .
- 2 Press All Settings.
- 3 Swipe up or down, or press ▲ or ▼ to display Fax.
- 4 Press Fax.
- 5 Swipe up or down, or press ▲ or ▼ to display Dial Restriction.
- 6 Press Dial Restriction.
- 7 Press Shortcuts.
- 8 Press Enter # Twice, On or Off.
- 9 Press .

LDAP Server restriction

- 1 Press .
- 2 Press All Settings.
- 3 Swipe up or down, or press ▲ or ▼ to display Fax.
- 4 Press Fax.
- 5 Swipe up or down, or press ▲ or ▼ to display Dial Restriction.
- 6 Press Dial Restriction.
- 7 Press LDAP Server.
- 8 Press Enter # Twice, On or Off.
- 9 Press .

Additional sending options

Sending faxes using multiple settings

When you send a fax, you can choose a combination of settings, such as Fax Resolution, Contrast, Glass Scan Size, and Real Time TX.

You can also choose: Call History, Address Book, Broadcasting, Preview, Colour Setting, Delayed Fax, Batch TX, Polled TX, Polling RX, Overseas Mode, Set New Default, and Factory Reset.

Some settings are only available when sending mono faxes.

- 1 Load your document.
- 2 Do one of the following:
 - When Fax Preview is set to off, press Fax.
 - When Fax Preview is set to on, press Fax and then Sending Faxes.

The Touchscreen shows:

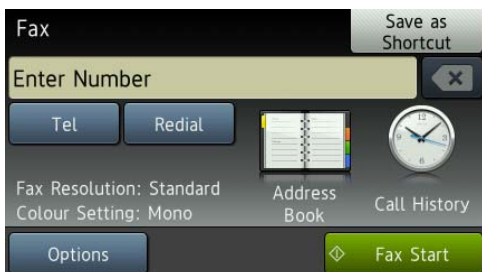

- 3 Press Options.
- 4 Swipe up or down, or press ▲ or ▼ to display the setting you want to change. When the setting is displayed, press it.
- 5 Press the option you want to set.

- 6 Go back to step 4 to change more settings.
- 7 Press OK when you have finished changing settings.
- 8 Enter the fax number.
- 9 Press Fax Start.

NOTE

- Most settings are temporary and the machine returns to its default settings after you send a fax.
- You can save some of the settings you use most often by setting them as the default settings. These settings will remain until you change them again. (See *Setting your changes as a new default* on page 11.)
- You can also save some of the settings you use most often by setting them as a Shortcut. (See *Saving fax options as a Shortcut* on page 12.)

Stop faxing

To stop faxing, press .

Contrast

If your document is very light or very dark, you may want to change the contrast. For most documents, the factory setting `Auto` can be used. It automatically chooses the suitable contrast for your document.

Choose `Light` when sending a light document. Choose `Dark` when sending a dark document.

- 1 Load your document.
- 2 Do one of the following:
 - When Fax Preview is set to off, press `Fax`.
 - When Fax Preview is set to on, press `Fax` and then `Sending Faxes`.
- 3 Press `Options`.
- 4 Swipe up or down, or press `▲` or `▼` to display `Contrast`.
- 5 Press `Contrast`.
- 6 Press `Auto`, `Light` or `Dark`.
- 7 Press `OK`.
- 8 Enter the fax number.
- 9 Press `Fax Start`.

NOTE

Even if you choose `Light` or `Dark`, the machine will send the fax using the `Auto` setting in any of the following conditions:

- When you send a colour fax.
 - When you choose `Photo` as the Fax Resolution.
-

Changing fax resolution

The quality of a fax can be improved by changing the fax resolution.

- 1 Load your document.
- 2 Do one of the following:
 - When Fax Preview is set to off, press `Fax`.
 - When Fax Preview is set to on, press `Fax` and then `Sending Faxes`.
- 3 Press `Options`.
- 4 Swipe up or down, or press `▲` or `▼` to display `Fax Resolution`.
- 5 Press `Fax Resolution`.
- 6 Press `Standard`, `Fine`, `S.Fine` or `Photo`.
- 7 Press `OK`.
- 8 Enter the fax number.
- 9 Press `Fax Start`.

NOTE

You can choose four different resolution settings for monochrome faxes and two for colour.

Monochrome	
Standard	Suitable for most typed documents.
Fine	Good for small print and transmits a little slower than Standard resolution.
S.Fine	Good for small print or artwork and transmits slower than Fine resolution.
Photo	Use when the document has varying shades of grey or is a photograph. Photo has the slowest transmission.

Colour	
Standard	Suitable for most typed documents.
Fine	Use when the document is a photograph. The transmission time is slower than Standard resolution.

If you choose **S.Fine** or **Photo** and then send a colour fax (choosing **Colour** in **Colour Setting**), the machine will send the fax using the **Fine** setting.

Setting your changes as a new default

You can save the settings for the fax options you use most often by setting them as the default settings, such as **Fax Resolution**, **Contrast**, **Glass Scan Size**, **Preview**, **Real Time TX** and **Colour Setting**. These settings will remain until you change them again.

- 1 Do one of the following:
 - When **Fax Preview** is set to off, press **Fax**.
 - When **Fax Preview** is set to on, press **Fax** and then **Sending Faxes**.
- 2 Press **Options**.
- 3 Swipe up or down, or press ▲ or ▼ to choose the menu option that you want to change. Press your new option.

Repeat this step for each setting you want to change.
- 4 After changing the last setting to your preferred option, swipe up or down, or press ▲ or ▼ to display **Set New Default**.
- 5 Press **Set New Default**.
- 6 The Touchscreen asks you to confirm the change to the new default settings. Press **Yes** to confirm.
- 7 Press .

Restoring fax options to the factory default

You can restore all the fax options you have changed back to the factory default. These settings will remain until you change them again.

- 1 Do one of the following:
 - When Fax Preview is set to off, press `Fax`.
 - When Fax Preview is set to on, press `Fax` and then `Sending Faxes`.
- 2 Press `Options`.
- 3 Swipe up or down, or press ▲ or ▼ to display `Factory Reset`.
- 4 Press `Factory Reset`.
- 5 The Touchscreen asks you to confirm to change back to the factory default. Press `Yes` to confirm.
- 6 Press .

Saving fax options as a Shortcut

You can store all the new fax options you use frequently by saving them as a Shortcut.

- 1 Do one of the following:
 - When Fax Preview is set to off, press `Fax`.
 - When Fax Preview is set to on, press `Fax` and then `Sending Faxes`.
- 2 Enter the fax number.
- 3 Press `Options`.
- 4 Swipe up or down, or press ▲ or ▼ to display `Fax Resolution`, `Contrast`, `Preview`, `Colour Setting`, `Real Time TX`, `Overseas Mode` or `Glass Scan Size`, and then press the setting you want to change. Then press the new option you want to set. Repeat this step for each setting you want to change.
- 5 When you have finished choosing new options, press `OK`.
- 6 Press `Save as Shortcut`.
- 7 Confirm the displayed list of options you have chosen for the Shortcut, and then press `OK`.
- 8 Enter a name for the Shortcut using the keyboard on the Touchscreen. (To help you enter letters, see Basic User's Guide: *Entering Text*.) Press `OK`.
- 9 Press `OK` to save your Shortcut.

Additional sending operations

Sending a fax manually

Manual transmission lets you hear the dialling, ringing and fax-receiving tones while sending a fax.

NOTE

To send a multi-page fax, use the ADF.

- 1 Load your document.
- 2 Do one of the following:
 - When Fax Preview is set to off, press **Fax**.
 - When Fax Preview is set to on, press **Fax** and then **Sending Faxes**.
- 3 To listen for a dial tone, press **Hook**.
- 4 Dial the fax number.
- 5 When you hear the fax tones, press **Fax Start**.
If you are using the scanner glass, press **Send** on the Touchscreen to send the fax.

Sending a fax at the end of a conversation

At the end of a conversation, you can send a fax to the other party before you both hang up.

- 1 Ask the other party to wait for fax tones (beeps) and then to press the **Start** or **Send** key before hanging up.
- 2 Load your document.
- 3 Press **Fax Start**.
 - If you are using the scanner glass, press **Send** to send the fax.
- 4 Replace the handset of the external phone.

3

Dual Access (Monochrome only)

You can dial a number and start scanning the fax into memory—even when the machine is sending from memory, receiving faxes or printing PC data. The Touchscreen shows the new job number.

The number of pages you can scan into the memory will vary depending on the data that is printed on them.

NOTE

If the **Out of Memory** message appears, press **X** to cancel or **Send Now** to send the pages scanned so far.

Broadcasting (Monochrome only)

Broadcasting is when the same fax message is automatically sent to more than one fax number. You can include Groups, Address Book numbers, and up to 50 manually dialled numbers in the same broadcast.

After the broadcast is finished, a Broadcast Report will be printed.

Before you begin the broadcast

Address Book numbers must be stored in the machine's memory before they can be used in a broadcast. (See Basic User's Guide: *Storing Address Book numbers.*)

Group numbers must also be stored in the machine's memory before they can be used in a broadcast. Group numbers include many stored Address Book numbers for easier dialling. (See *Setting up Groups for Broadcasting* on page 34.)

How to broadcast a fax

- 1 Load your document.
- 2 Do one of the following:
 - When Fax Preview is set to off, press `Fax`.
 - When Fax Preview is set to on, press `Fax` and then `Sending Faxes`.
- 3 Press `Options`.
- 4 Swipe up or down, or press `▲` or `▼` to display `Broadcasting`.
- 5 Press `Broadcasting`.
- 6 Press `Add Number`.

- 7 You can add numbers to the broadcast in the following ways:

- Press `Add Number` and enter a number using the keyboard on the Touchscreen.

Press `OK`.

NOTE

If you downloaded Internet Fax:

If you want to broadcast using an E-mail address, press , enter the E-mail address, and press `OK`. (See Basic User's Guide: *Entering Text.*)

- Press `Add from Address book`.
Swipe up or down, or press `▲` or `▼` to display the number you want to add to the broadcast.
Press the check boxes of the numbers you want to add to the broadcast.
After you have checked all the numbers you want, press `OK`.
- Press `Search in Address book`.
Enter the first letter of the name and press `OK`.
Press the name, and then press the number you want to add to the broadcast.

- 8 After you have entered all the fax numbers by repeating steps 6 and 7, press `OK`.

- 9 Press **Fax Start**.

NOTE

Broadcasting is not available when you select **Colour** in **Colour Setting**.

Faxing from the ADF

- The machine starts scanning the document.

Faxing from the scanner glass

When the Touchscreen asks you **Next page?**, do one of the following:

- To send a single page, press **No**.
The machine starts sending the document.
- To send more than one page, press **Yes** and place the next page on the scanner glass.



Press **OK**.

The machine starts scanning the page. (Repeat this step for each additional page.)

NOTE

- If you did not use up any of the numbers for **Groups**, you can “broadcast” faxes to as many as 250 different numbers.
- The machine’s available memory will vary depending on the types of jobs in the memory and the numbers used for broadcasting. If you broadcast to the maximum numbers available, you will not be able to use dual access and delayed fax.
- If the **Out of Memory** message appears, press  to cancel or **Send Now** to send the pages scanned so far.

Cancelling a Broadcast in progress

- 1 Press .
- 2 Do one of the following:
 - To cancel the entire broadcast, press **Entire Broadcast**. Go to step 3.
 - To cancel the current job, press the number being dialled on the Touchscreen. Go to step 4.
 - To exit without cancelling, press .
- 3 When the Touchscreen asks if you want to cancel the entire broadcast, do one of the following:
 - Press **Yes** to confirm.
 - To exit without cancelling, press **No**.
- 4 Do one of the following:
 - To cancel the current job, press **Yes**.
 - To exit without cancelling, press **No**.

Real Time Transmission

When you are sending a fax, the machine will scan the documents into the memory before sending. Then, as soon as the telephone line is free, the machine will start dialling and sending.

Sometimes, you may want to send an important document immediately, without waiting for memory transmission. You can do this by turning on **Real Time TX**.

- 1 Load your document.
- 2 Do one of the following:
 - When **Fax Preview** is set to off, press **Fax**.
 - When **Fax Preview** is set to on, press **Fax** and then **Sending Faxes**.
- 3 Press **Options**.

- 4 Swipe up or down, or press ▲ or ▼ to display **Real Time TX**.
- 5 Press **Real Time TX**.
- 6 Press **On (or Off)**.
- 7 Press **OK**.
- 8 Enter the fax number.
- 9 Press **Fax Start**.

NOTE

- If you are sending a colour fax or if the memory is full and you are sending a monochrome fax from the ADF, the machine will send the document in real time (even if **Real Time TX** is set to **Off**).
- In Real Time Transmission, the automatic redial feature does not work when you are using the scanner glass.

Overseas Mode

If you are having difficulty sending a fax overseas due to possible interference on the telephone line, we recommend that you turn on Overseas Mode. After you send a fax using this feature, the feature will automatically turn itself off.

- 1 Load your document.
- 2 Do one of the following:
 - When Fax Preview is set to off, press **Fax**.
 - When Fax Preview is set to on, press **Fax** and then **Sending Faxes**.
- 3 Press **Options**.
- 4 Swipe up or down, or press ▲ or ▼ to display **Overseas Mode**.
- 5 Press **Overseas Mode**.
- 6 Press **On (or Off)**.

- 7 Press **OK**.
- 8 Enter the fax number.
- 9 Press **Fax Start**.

Delayed Faxing (Monochrome only)

You can store up to 50 faxes in the memory to be sent within 24 hours. These faxes will be sent at the time of day you enter in step 9.

- 1 Load your document.
- 2 Do one of the following:
 - When Fax Preview is set to off, press **Fax**.
 - When Fax Preview is set to on, press **Fax** and then **Sending Faxes**.
- 3 Press **Options**.
- 4 Swipe up or down, or press ▲ or ▼ to display **Delayed Fax**.
- 5 Press **Delayed Fax**.
- 6 Press **Delayed Fax**.
- 7 Press **On (or Off)**.
- 8 Press **Set Time**.
- 9 Enter the time you want the fax to be sent (in 24-hour format) using the keyboard on the Touchscreen. (For example, enter 19:45 for 7:45 PM.) Press **OK**.

NOTE

The number of pages you can scan into the memory depends on the amount of data that is printed on each page.

- 10 Press **OK**.
- 11 Enter the fax number.
- 12 Press **Fax Start**.

NOTE

Delayed Fax is not available when you select **Colour** in **Colour Setting**.



Delayed Batch Transmission (Monochrome only)

Before sending the delayed faxes, your machine will help you economize by sorting all the faxes in the memory by destination and scheduled time. All delayed faxes that are scheduled to be sent at the same time to the same fax number will be sent as one fax to save transmission time.

- 1 Do one of the following:
 - When Fax Preview is set to off, press **Fax**.
 - When Fax Preview is set to on, press **Fax** and then **Sending Faxes**.
- 2 Press **Options**.
- 3 Swipe up or down, or press ▲ or ▼ to display **Batch TX**.
- 4 Press **Batch TX**.
- 5 Press **On (or Off)**.
- 6 Press .

Checking and cancelling waiting jobs

You can check which jobs are still waiting in the memory to be sent, or cancel a job. (If there are no jobs, the Touchscreen shows **No Jobs Waiting**.)

- 1 Press .
- 2 Press **All Settings**.
- 3 Swipe up or down, or press ▲ or ▼ to display **Fax**.
- 4 Press **Fax**.
- 5 Swipe up or down, or press ▲ or ▼ to display **Remaining Jobs**.
- 6 Press **Remaining Jobs**. Any waiting jobs appear on the Touchscreen.
- 7 Swipe up or down, or press ▲ or ▼ to scroll through the jobs and press the job you want to cancel. Press **Cancel**.
- 8 Do one of the following:
 - To cancel, press **Yes**.
If you want to cancel another job, go to step 7.
 - To exit without cancelling, press **No**.
- 9 When you have finished, press .

Polling overview

Polling lets you set up your machine so other people can receive faxes from you, but they pay for the call. It also lets you call somebody else's fax machine and receive a fax from it, so you pay for the call. The polling feature needs to be set up on both machines for this to work. Not all fax machines support polling.

Polled Transmit (Monochrome only)

Polled transmit lets you set up your machine to wait with a document so another fax machine can call and retrieve it.

The document will be stored and can be retrieved by any other fax machine until you delete it from the memory. (See *Checking and cancelling waiting jobs* on page 17.)

Setup for polled transmit

- 1 Load your document.
- 2 Do one of the following:
 - When Fax Preview is set to off, press **Fax**.
 - When Fax Preview is set to on, press **Fax** and then **Sending Faxes**.
- 3 Press **Options**.
- 4 Swipe up or down, or press **▲** or **▼** to display **Polled TX**.
- 5 Press **Polled TX**.
- 6 Press **Standard**.
- 7 Press **Fax Start**.

- 8 If you are using the scanner glass, the Touchscreen will prompt you to choose one of the following options:
 - Press **Yes** to scan another page. Go to step 9.
 - Press **No** to store the document in the memory. Other fax machines can now call your machine and retrieve the document.
- 9 Place the next page on the scanner glass and press **OK**. Repeat steps 8 and 9 for each additional page. The document will be stored in the memory and will be sent when it is polled.

Setup for polled transmit with secure code

Secure Polling lets you restrict who can get the documents you set up to be polled.

Secure Polling only works with Brother fax machines. If another person wants to retrieve a fax from your machine, they will have to enter the secure code.

- 1 Load your document.
- 2 Do one of the following:
 - When Fax Preview is set to off, press **Fax**.
 - When Fax Preview is set to on, press **Fax** and then **Sending Faxes**.
- 3 Press **Options**.
- 4 Swipe up or down, or press **▲** or **▼** to display **Polled TX**.
- 5 Press **Polled TX**.
- 6 Press **Secure**.
- 7 Enter a four-digit number. Press **OK**.
- 8 Press **Fax Start**.

- 9 If you are using the scanner glass, the Touchscreen will prompt you to choose one of the following options:
 - Press **Yes** to scan another page. Go to step 10.
 - Press **No** to send the document.
- 10 Place the next page on the scanner glass and press **OK**.
- 11 Repeat steps 9 and 10 for each additional page. Your machine will automatically send the fax.

4

Receiving a fax

Memory Receive (Monochrome only)

You can only use one Memory Receive operation at a time:

- Fax Forwarding
- Fax Storage
- PC-Fax Receive
- Off

You can change your selection at any time. If received faxes are still in the machine's memory when you change the Memory Receive operation, a message will appear on the Touchscreen. (See *Changing Memory Receive operations* on page 23.)

Fax Forwarding

When you choose Fax Forward, your machine stores the received fax in the memory. The machine will then dial the fax number you have programmed and forward the fax message.

- 1 Press .
- 2 Press `All Settings`.
- 3 Swipe up or down, or press ▲ or ▼ to display `Fax`.
- 4 Press `Fax`.
- 5 Swipe up or down, or press ▲ or ▼ to display `Setup Receive`.
- 6 Press `Setup Receive`.
- 7 Swipe up or down, or press ▲ or ▼ to display `Memory Receive`.
- 8 Press `Memory Receive`.

- 9 Press `Fax Forward`.
- 10 Enter the forwarding number (up to 20 digits) using the keyboard on the Touchscreen.
Press `OK`.
- 11 If `Fax Preview` is set to `Off`, press `Backup Print: On` or `Backup Print: Off`.

IMPORTANT

- If you choose `Backup Print: On`, the machine will also print the fax at your machine so you will have a copy. This is a safety feature in case there is a power failure before the fax is forwarded or a problem at the receiving machine.
- When you receive a colour fax, your machine prints the colour fax at your machine but does not forward the fax to the fax forwarding number you programmed.

- 12 Press .

Fax Storage

If you choose Fax Storage, your machine stores received faxes in the memory. You will be able to retrieve fax messages from another location using the remote retrieval commands.

If you have turned on Fax Storage, a backup copy will automatically be printed at the machine.

- 1 Press .
- 2 Press `All Settings`.
- 3 Swipe up or down, or press ▲ or ▼ to display `Fax`.
- 4 Press `Fax`.



- 5 Swipe up or down, or press ▲ or ▼ to display `Setup Receive`.
- 6 Press `Setup Receive`.
- 7 Swipe up or down, or press ▲ or ▼ to display `Memory Receive`.
- 8 Press `Memory Receive`.
- 9 Press `Fax Storage`.
- 10 Press .

NOTE

Colour faxes cannot be stored in the memory. When you receive a colour fax, your machine prints the colour fax at your machine.

Printing a fax from the memory

If you have chosen `Fax Storage`, you can still print a fax from the memory when you are at your machine.

- 1 Press .
- 2 Press `All Settings`.
- 3 Swipe up or down, or press ▲ or ▼ to display `Fax`.
- 4 Press `Fax`.
- 5 Swipe up or down, or press ▲ or ▼ to display `Print Document`.
- 6 Press `Print Document`.
- 7 Press `OK`.
- 8 Press .

NOTE

When you print a fax from the memory, the fax data will be erased from your machine.

PC-Fax Receive (Windows® only)

If you turn on the PC-Fax Receive feature, your machine will store received faxes in the memory and send them to your PC automatically. You can then use your PC to view and store these faxes.

Even if you have turned off your PC (at night or on the weekend, for example), your machine will receive and store your faxes in its memory.

When you start your PC and the PC-FAX Receiving software runs, your machine transfers your faxes to your PC automatically.

To transfer the received faxes to your PC you must have the PC-FAX Receiving software running on your PC. (See Software User's Guide: *PC-FAX receiving*.)

If you choose `Backup Print: On`, the machine will also print the fax.

- 1 Press .
- 2 Press `All Settings`.
- 3 Swipe up or down, or press ▲ or ▼ to display `Fax`.
- 4 Press `Fax`.
- 5 Swipe up or down, or press ▲ or ▼ to display `Setup Receive`.
- 6 Press `Setup Receive`.
- 7 Swipe up or down, or press ▲ or ▼ to display `Memory Receive`.
- 8 Press `Memory Receive`.
- 9 Press `PC Fax Receive`.
- 10 The Touchscreen shows the message `Run PC-Fax on your computer`. Press `OK`.

- 11 Press <USB> or the name of the PC you want to receive faxes if you are on a network.
Press **OK**.
- 12 If Fax Preview is set to Off, press Backup Print: On or Backup Print: Off.
- 13 Press .

NOTE

- PC-Fax Receive is not supported by Mac OS.
- Before you can set up PC-Fax Receive, you must install the MFL-Pro Suite software on your PC. Make sure your PC is connected and turned on. (See Software User's Guide: *PC-FAX receiving*.)
- If you get an error message and the machine cannot print the faxes in the memory, you can use this setting to transfer your faxes to your PC. (See Basic User's Guide: *Transferring your faxes or Fax Journal report*.)
- When you receive a colour fax, your machine prints the colour fax at your machine but does not send the fax to your PC.
- To change the destination PC, repeat steps 11 to 13.

Turning off Memory Receive operations

- 1 Press .
- 2 Press All Settings.
- 3 Swipe up or down, or press ▲ or ▼ to display Fax.
- 4 Press Fax.
- 5 Swipe up or down, or press ▲ or ▼ to display Setup Receive.
- 6 Press Setup Receive.
- 7 Swipe up or down, or press ▲ or ▼ to display Memory Receive.
- 8 Press Memory Receive.
- 9 Press Off.
- 10 Press .

NOTE

The Touchscreen will show you more options if there are received faxes still in the machine's memory. (See *Changing Memory Receive operations* on page 23.)

Changing Memory Receive operations

If there are received faxes in your machine's memory when you change the Memory Receive operations, the Touchscreen will ask you one of the following questions:

If all the received faxes have already been printed

- Erase all documents?
 - If you press **Yes**, faxes in the memory will be erased before the setting changes.
 - If you press **No**, faxes in the memory will not be erased and the setting will be unchanged.

If unprinted faxes remain in the memory

- Print all faxes?
 - If you press **Yes**, faxes in the memory will be printed before the setting changes. If a backup copy has already been printed, it will not be printed again.
 - If you press **No**, faxes in the memory will not be printed and the setting will be unchanged.

If received faxes are left in the machine's memory when you change to PC Fax Receive from another option [Fax Forward or Fax Storage], press <USB> or the name of the PC if you are on a network.

Press **OK**.

The Touchscreen will ask you the following question:

- Send Fax to PC?
 - If you press **Yes**, faxes in the memory will be sent to your PC before the setting changes. You will be asked if you want to turn on Backup Print. (For details, see *PC-Fax Receive (Windows® only)* on page 21.)
 - If you press **No**, faxes in the memory will not be erased or transferred to your PC and the setting will be unchanged.

Remote Retrieval

You can call your machine from any touch-tone telephone or fax machine and then use the remote access code and remote commands to retrieve fax messages.

Setting a Remote Access Code

The Remote Access Code lets you access the remote retrieval features when you are away from your machine. Before you can use the remote access and retrieval features, you have to set up your own code. The factory default code is the inactive code (---*).

- 1 Press .
- 2 Press `All Settings`.
- 3 Swipe up or down, or press ▲ or ▼ to display `Fax`.
- 4 Press `Fax`.
- 5 Swipe up or down, or press ▲ or ▼ to display `Remote Access`.
- 6 Press `Remote Access`.
- 7 Enter a three-digit code using numbers 0 to 9, *, or # using the keyboard on the Touchscreen.
Press `OK`.
(The preset '*' cannot be changed.)

NOTE

Do not use the same code as your Remote Activation Code (* 5 1 (* 9 1 for New Zealand)) or Remote Deactivation Code (# 5 1 (# 9 1 for New Zealand)). (See Basic User's Guide: *Operation from external and extension telephones*.)

- 8 Press .

NOTE

You can change your code at any time by entering a new one. If you want to make your code inactive, press and hold  in step 7 to restore the inactive setting (---*) and press `OK`.

Using your Remote Access Code

- 1 Dial your fax number from a touch-tone telephone or another fax machine.
- 2 When your machine answers, enter your remote access code (3 digits followed by *) at once.
- 3 The machine signals if it has received messages:
 - 1 long beep — Fax messages
 - No beeps — No messages
- 4 When the machine gives two short beeps, enter a command.
The machine will hang up if you wait longer than 30 seconds to enter a command.
The machine will beep three times if you enter an invalid command.
- 5 Press `9 0` to stop Remote Access when you have finished.
- 6 Hang up.

NOTE

If your machine is set to `Manual` mode and you want to use the remote retrieval features, wait for about 100 seconds after it starts ringing, and then enter the remote access code within 30 seconds. This function may not be available in some countries e.g. Australia.

Remote Fax commands

Follow the commands below to access features when you are away from the machine. When you call the machine and enter your remote access code (3 digits followed by *), the system will give two short beeps and you must enter a remote command.

Remote commands		Operation details
95	Change the Fax Forwarding or Fax Storage settings	
	1 OFF	You can choose <code>OFF</code> after you have retrieved or erased all your messages.
	2 Fax Forwarding	One long beep means the change is accepted. If you hear three short beeps, the change was not accepted because something has not been set up (for example, a Fax Forwarding number has not been registered). You can register your Fax Forwarding number by entering 4. (See <i>Changing your Fax Forwarding number</i> on page 26.) Once you have registered the number, Fax Forwarding will work.
	4 Fax Forwarding number	
6 Fax Storage		
96	Retrieve a fax	
	2 Retrieve all faxes	Enter the number of a remote fax machine to receive stored fax messages. (See <i>Retrieving fax messages</i> on page 26.)
	3 Erase faxes from the memory	If you hear one long beep, fax messages have been erased from the memory.
97	Check the receiving status	
	1 Fax	You can check whether your machine has received any faxes. If yes, you will hear one long beep. If no, you will hear three short beeps.
98	Change the Receive Mode	
	1 External TAD	If you hear one long beep, your change has been accepted.
	2 Fax/Tel	
	3 Fax Only	
90	Exit	Pressing 9 0 allows you to exit remote retrieval. Wait for the long beep, then replace the handset.

Retrieving fax messages

You can call your machine from any touch-tone telephone and have your fax messages sent to another machine. Before you use this feature, you have to turn on Fax Storage or Fax Preview. (See *Fax Storage* on page 20 or see *Basic User's Guide: Fax Preview (Monochrome only)*.)

- 1 Dial your fax number.
- 2 When your machine answers, enter your remote access code (3 digits followed by *) at once. If you hear one long beep, you have messages.
- 3 When you hear two short beeps, press **9 6 2**.
- 4 Wait for a long beep, and then use the dial pad to enter the number of the remote fax machine where you want your fax messages sent, followed by **# #** (up to 20 digits).

NOTE

You cannot use * and # as dial numbers. However, press # if you want to create a pause.

- 5 Hang up after you hear your machine beep. Your machine will call the other fax machine, which will then print your fax messages.

Changing your Fax Forwarding number

You can change the default setting of your fax forwarding number from another touch-tone telephone or fax machine.

- 1 Dial your fax number.
- 2 When your machine answers, enter your remote access code (3 digits followed by *) at once. If you hear one long beep, you have messages.
- 3 When you hear two short beeps, press **9 5 4**.
- 4 Wait for the long beep, enter the new number (up to 20 digits) of the remote fax machine you want your fax messages forwarded to using the dial pad, then enter **# #**.

NOTE

You cannot use * and # as dial numbers. However, press # if you want to create a pause.

- 5 Press **9 0** to stop Remote Access when you have finished.
- 6 Hang up after you hear your machine beep.

Additional receiving operations

Out of Paper Reception

As soon as the paper tray becomes empty during fax reception, the Touchscreen shows **No Paper Fed**. Put some paper in the paper tray. (See Basic User's Guide: *Loading paper and other print media*.)

If you don't put paper in the paper tray, the machine will carry on receiving the fax, with the remaining pages being stored in the memory, if enough memory is available.

Further incoming faxes will also be stored in memory until the memory is full. To print the faxes, put fresh paper in the tray. When the memory is full, the machine will stop automatically answering calls.

Printing a reduced incoming fax

If you choose **On**, the machine automatically reduces each page of an incoming fax to fit on one sheet of A4 or Letter size paper. The machine calculates the reduction ratio by using the page size of the fax and your **Paper Size** setting.

(See Basic User's Guide: *Paper Size*.)

- 1 Press .
- 2 Press **All Settings**.
- 3 Swipe up or down, or press ▲ or ▼ to display **Fax**.
- 4 Press **Fax**.
- 5 Swipe up or down, or press ▲ or ▼ to display **Setup Receive**.
- 6 Press **Setup Receive**.
- 7 Swipe up or down, or press ▲ or ▼ to display **Auto Reduction**.

- 8 Press **Auto Reduction**.
- 9 Press **On** (or **Off**).
- 10 Press .

Receiving a fax at the end of a conversation

At the end of a conversation, you can ask the other party to fax you information before you both hang up.

- 1 Ask the other party to place the document in their machine and to press the **Start** or **Send** key.
- 2 When you hear the other machine's CNG tones (slowly repeating beeps), press **Fax Start**.

NOTE

If the Touchscreen is dark for Sleep mode, touch it to display **Fax Start**.

- 3 Press **Receive** to receive the fax.
- 4 Replace the handset of the external telephone.

Fax recovery printing



When you set Fax Preview and Memory Receive to Off, the machine temporarily stores a fax data in the memory for about ten days.

You can print it again within this period.



NOTE

- Colour faxes cannot be stored in the memory.
- The machine temporarily stores up to five faxes.



Setting fax recovery printing

- 1 Press .
- 2 Press All Settings.
- 3 Swipe up or down, or press ▲ or ▼ to display Initial Setup.
- 4 Press Initial Setup.
- 5 Swipe up or down, or press ▲ or ▼ to display Miscellaneous.
- 6 Press Miscellaneous.
- 7 Press Temporary Fax Backup.
- 8 Press Backup.
- 9 Press On (or Off).
- 10 Press .

Printing fax recovery data

- 1 Press .
- 2 Press All Settings.
- 3 Swipe up or down, or press ▲ or ▼ to display Initial Setup.
- 4 Press Initial Setup.
- 5 Swipe up or down, or press ▲ or ▼ to display Miscellaneous.
- 6 Press Miscellaneous.
- 7 Press Temporary Fax Backup.
- 8 Press Reprint.
- 9 Press OK to confirm.
- 10 Press .

Deleting fax recovery data

- 1 Press .
- 2 Press All Settings.
- 3 Swipe up or down, or press ▲ or ▼ to display Initial Setup.
- 4 Press Initial Setup.
- 5 Swipe up or down, or press ▲ or ▼ to display Miscellaneous.
- 6 Press Miscellaneous.
- 7 Press Temporary Fax Backup.
- 8 Press Delete.
- 9 Press Yes to confirm.
- 10 Press .

Polling overview

Polling lets you set up your machine so other people can receive faxes from you, but they pay for the call. It also lets you call somebody else's fax machine and receive a fax from it, so you pay for the call. The polling feature needs to be set up on both machines for this to work. Not all fax machines support polling.

Polling receive

Polling receive lets you call another fax machine to receive a fax.

Setup to receive polling

- 1 Do one of the following:
 - When Fax Preview is set to off, press Fax.
 - When Fax Preview is set to on, press Fax and then Sending Faxes.
- 2 Press Options.
- 3 Swipe up or down, or press ▲ or ▼ to display Polling RX.
- 4 Press Polling RX.
- 5 Press Standard.
- 6 Enter the fax number you are polling using Address Book or the dial pad on the Touchpanel.
- 7 Press Fax Start.

Setup to receive polling with secure code

Secure Polling lets you restrict who can get the documents you set up to be polled.

Secure Polling only works with Brother fax machines. If you want to get a fax from a secured Brother machine you have to enter the secure code.

- 1 Do one of the following:
 - When Fax Preview is set to off, press Fax.
 - When Fax Preview is set to on, press Fax and then Sending Faxes.
- 2 Press Options.
- 3 Swipe up or down, or press ▲ or ▼ to display Polling RX.
- 4 Press Polling RX.
- 5 Press Secure.
- 6 Enter a four-digit secure code using the keyboard on the Touchscreen. This is the same as the security code of the fax machine you are polling. Press OK.
- 7 Enter the fax number you are polling by either using Address Book or the dial pad on the control panel.
- 8 Press Fax Start.

Setup to receive delayed polling

Delayed polling lets you set the machine to begin polling receive at a later time. You can only set up *one* delayed polling operation.

- 1 Do one of the following:
 - When Fax Preview is set to off, press **Fax**.
 - When Fax Preview is set to on, press **Fax** and then **Sending Faxes**.
- 2 Press **Options**.
- 3 Swipe up or down, or press **▲** or **▼** to display **Polling RX**.
- 4 Press **Polling RX**.
- 5 Press **Timer**.
- 6 Enter the time (in 24-hour format) you want to start polling.
For example, enter 21:45 for 9:45 PM.
Press **OK**.
- 7 Enter the fax number you are polling by either using **Address Book** or the dial pad on the control panel.
- 8 Press **Fax Start**.
The machine makes the polling call at the time you entered.

Sequential polling (Monochrome only)

Sequential polling lets you request documents from several fax machines in one operation.

- 1 Do one of the following:
 - When Fax Preview is set to off, press **Fax**.
 - When Fax Preview is set to on, press **Fax** and then **Sending Faxes**.
- 2 Press **Options**.
- 3 Swipe up or down, or press **▲** or **▼** to display **Polling RX**.
- 4 Press **Polling RX**.
- 5 Press **Standard**, **Secure** or **Timer**.
- 6 Do one of the following:
 - If you chose **Standard**, go to step 7.
 - If you chose **Secure**, enter a four-digit number, press **OK**, go to step 7.
 - If you chose **Timer**, enter the time (24-hour format) you want to begin polling and press **OK**, go to step 7.
- 7 Press **Options**. Swipe up or down, or press **▲** or **▼** to display **Broadcasting**.
- 8 Press **Broadcasting**.
- 9 Press **Add Number**.

- 10 You can add numbers to the broadcast in the following ways:

- Press **Add Number** and enter a number using the keyboard on the Touchscreen.
Press **OK**.

NOTE

If you downloaded Internet Fax:

If you want to broadcast using an E-mail address, press , enter the E-mail address, and press **OK**. (See Basic User's Guide: *Entering Text*.)

- Press **Add from Address book**.
Swipe up or down, or press **▲** or **▼** to display the number you want to add to the broadcast.
Press the check boxes of the numbers you want to add to the broadcast.
After you have checked all the numbers you want, press **OK**.
- Press **Search in Address book**.
Enter the first letter of the name and press **OK**.
Press the name, and then press the number you want to add to the broadcast.



- 11 After you have entered all the fax numbers by repeating steps 9 and 10, press **OK**.

- 12 Press **Fax Start**.
The machine polls each number or group in turn for a document.

Press  while the machine is dialling to cancel the polling process.

To cancel all sequential polling receive jobs, see *Cancelling a Sequential Polling Job* on page 31.

Cancelling a Sequential Polling Job

- 1 Press .
- 2 Do one of the following:
 - To cancel the entire sequential polling job, press **Entire Seq. Poll**. Go to step 3.
 - To cancel the current job, press the number being dialled on the Touchscreen. Go to step 4.
 - To exit without cancelling, press .
- 3 When the Touchscreen asks if you want to cancel the entire sequential polling job, do one of the following:
 - Press **Yes** to confirm.
 - To exit without cancelling, press **No**.
- 4 Do one of the following:
 - To cancel the current job, press **Yes**.
 - To exit without cancelling, press **No**.

Additional dialling operations

Combining Address Book numbers

Sometimes, you may want to choose from several long-distance carriers when you send a fax. Rates may vary depending on the time and destination. To take advantage of low rates, you can store the access codes of long-distance carriers and credit card numbers as Address Book numbers. You can store these long dialling sequences by dividing them and setting them up as separate Address Book numbers in any combination. You can even include manual dialling using the dial pad. (See Basic User's Guide: *Storing Address Book numbers*.)

For example, you might have stored '01632' on Address Book: Brother 1 and '960555' on Address Book: Brother 2. You can use them both to dial '01632-960555' as shown in the following example:

- 1 Press **Fax**.
- 2 Press **Address Book**.
- 3 Swipe up or down, or press ▲ or ▼ to display the number of Brother 1.
- 4 Press the number.
- 5 Press **Apply**.
- 6 Press **Address Book**.
- 7 Swipe up or down, or press ▲ or ▼ to display the number of Brother 2.
- 8 Press the number.
- 9 Press **Apply**.

- 10 Press **Fax Start**.
You will dial '01632-960555'.

To temporarily change a number, you can substitute part of the number with manual dialling using the dial pad. For example, to change the number to 01632-960556, you could enter the number (Brother 1: 01632) using **Address Book**, press **Apply** and then press **960556** using the dial pad.

NOTE

If you must wait for another dial tone or signal at any point in the dialling sequence, create a pause in the number by pressing **Pause**. Each key press adds a 3.5 second delay. You can press **Pause** as many times as needed to increase the length of the pause.

Additional ways to store numbers

Storing Address Book numbers from Outgoing Calls

You can also store Address Book numbers from the Outgoing Call history.

- 1 Press **Fax**.
- 2 Press **Call History**.
- 3 Press **Outgoing Call**.
- 4 Swipe up or down, or press ▲ or ▼ to display the name or number you want to store.
- 5 Press the name or number you want to store.
- 6 Press **Edit**.
- 7 Press **Add to Address Book**.
- 8 Press **Name**.
- 9 Enter the name (up to 16 characters) using the keyboard on the Touchscreen. Press **OK**.
(To help you enter letters, see Basic User's Guide: *Entering Text*.)
- 10 If you want to store the second fax or telephone number, press **Address 2**. Enter the second fax or telephone number using the keyboard on the Touchscreen (up to 20 digits). Press **OK**.
- 11 Press **OK** to confirm the fax or telephone number you want to store.
- 12 Press .

Storing Address Book numbers from the Caller ID history

If you have the Caller ID subscriber service from your telephone company, you can also store Address Book numbers from incoming calls in the Caller ID history. (See Basic User's Guide: *Caller ID*.)

- 1 Press **Fax**.
- 2 Press **Call History**.
- 3 Press **Caller ID history**.
- 4 Swipe up or down, or press ▲ or ▼ to display the number you want to store.
- 5 Press the number you want to store.
- 6 Press **Edit**.
- 7 Press **Add to Address Book**.
- 8 Press **Name**.
- 9 Enter the name (up to 16 characters) using the keyboard on the Touchscreen. Press **OK**.
(To help you enter letters, see Basic User's Guide: *Entering Text*.)
- 10 If you want to store the second fax or telephone number, press **Address 2**. Enter the second fax or telephone number using the keyboard on the Touchscreen (up to 20 digits). Press **OK**.
- 11 Press **OK** to confirm the fax or telephone number you want to store.
- 12 Press .

Setting up Groups for Broadcasting

A Group, which can be stored on Address Book, allows you to send the same fax message to many fax numbers by pressing **Fax**, **Address Book**, **Apply** and **Fax Start**.

First, you'll need to store each fax number in Address Book. (See *Basic User's Guide: Storing Address Book numbers*.) Then you can include them as numbers in the Group. Each Group uses up an Address Book number. You can have up to six Groups, or you can assign up to 198 numbers to a large Group.

(See *Broadcasting (Monochrome only)* on page 14.)

- 1 Press **Fax**.
- 2 Press **Address Book**.
- 3 Press **Edit**.
- 4 Press **Setup Groups**.
- 5 Press **Name**.
- 6 Enter the Group name (up to 16 characters) using the keyboard on the Touchscreen.
Press **OK**.
- 7 Press **Add/Delete**.
- 8 Add Address Book numbers to the Group by pressing them to display a red checkmark. Press **OK**.
- 9 Read and confirm the displayed list of names and numbers you have chosen, and then press **OK** to save your Group.
- 10 Do one of the following:
 - To store another Group for broadcasting, repeat steps 3 to 9.
 - To finish storing Groups for broadcasting, press .

NOTE

You can print a list of all the Address Book numbers. (See *Reports* on page 37.)

Changing a Group name

- 1 Press **Fax**.
- 2 Press **Address Book**.
- 3 Press **Edit**.
- 4 Press **Change**.
- 5 Swipe up or down, or press **▲** or **▼** to display the Group you want to change.
- 6 Press the Group.
- 7 Press **Name**.
- 8 Enter the new name (up to 16 characters) using the keyboard on the Touchscreen.
Press **OK**.
(For example, type **NEW CLIENTS**.)

NOTE

How to change the stored name:

If you want to change a character, press **◀** or **▶** to position the cursor to highlight the character you want to change, and then press . Enter the new character.

(See *Basic User's Guide: Entering Text*.)

- 9 Press **OK**.
- 10 Press .

Deleting a Group

- 1 Press **Fax**.
- 2 Press **Address Book**.
- 3 Press **Edit**.
- 4 Press **Delete**.
- 5 Swipe up or down, or press ▲ or ▼ to display the Group you want to delete.
- 6 Press the Group name.
- 7 Press **OK**.
Press **Yes** to confirm.
- 8 Press .

Adding or Deleting a number in a Group

- 1 Press **Fax**.
- 2 Press **Address Book**.
- 3 Press **Edit**.
- 4 Press **Change**.
- 5 Swipe up or down, or press ▲ or ▼ to display the Group you want to change.
- 6 Press the Group.
- 7 Swipe up or down, or press ▲ or ▼ to display **Add/Delete**.
- 8 Press **Add/Delete**.
- 9 Swipe up or down, or press ▲ or ▼ to display the number you want to add or delete.
- 10 Do the following for each number you want to change:
 - To add a number to the Group, press the check box of the number to *add* a check mark.
 - To delete a number from the Group, press the check box of the number to *remove* the check mark.Press **OK** to confirm all your changes.
- 11 Press **OK**.
- 12 Press .

6

Printing reports

Fax reports

Press  on the Touchscreen to set up the Transmission Verification Report and the Journal Period.

Transmission Verification Report

You can use the Transmission Verification Report as proof that you sent a fax. (See Basic User's Guide: *Transmission Verification Report*.)

Fax Journal (activity report)

You can set the machine to print a journal at specific intervals (every 50 faxes, 6, 12 or 24 hours, 2 or 7 days). If you set the interval to **Off**, you can still print the report by following the steps in *How to print a report* on page 37. The factory default is **Every 50 Faxes**.

- 1 Press .
- 2 Press **All Settings**.
- 3 Swipe up or down, or press ▲ or ▼ to display **Fax**.
- 4 Press **Fax**.
- 5 Swipe up or down, or press ▲ or ▼ to display **Report Setting**.
- 6 Press **Report Setting**.
- 7 Press **Journal Period**.
- 8 Press **Journal Period**.

- 9 Swipe up or down, or press ▲ or ▼ to choose an interval.
If you choose **Every 50 Faxes**, go to step 13.

- **6, 12, 24 hours, 2 or 7 days**

The machine will print the report at the chosen time and then erase all jobs from its memory. If the machine's memory is filled with the maximum 200 jobs before the time you chose has passed, the machine will print the Fax Journal report early and then erase all jobs from the memory. If you want an extra report before it is due to print, you can print it without erasing the jobs from the memory.

- **Every 50 Faxes**

The machine will print the Fax Journal report when the machine has stored 50 jobs.

- 10 Press **Time**, and then enter the time to start printing (in 24-hour format) using the keyboard on the Touchscreen. Press **OK**.
(For example: enter 19:45 for 7:45 PM.)
- 11 If you choose **Every 7 Days**, press **Day**.
- 12 Swipe up or down, or press ▲ or ▼ to display **Every Monday**, **Every Tuesday**, **Every Wednesday**, **Every Thursday**, **Every Friday**, **Every Saturday** **OR** **Every Sunday**, and then press the first day for the 7-day countdown.
- 13 Press .

Reports

The following reports are available:

- **XMIT Verify**
Prints a Transmission Verification Report for your last transmission.
- **Address Book**
Prints a list of names and numbers stored in the Address Book memory, in alphabetical order.
- **Fax Journal**
Prints a list of information about the last incoming and outgoing faxes.
(TX: Transmit.) (RX: Receive.)
- **User Settings**
Prints a list of your settings.
- **Network Configuration**
Prints a list of your Network settings.
- **WLAN Report**
Prints a WLAN connection report.
- **Caller ID history**
Prints a list of the available Caller ID information about the last 30 received faxes and telephone calls.

How to print a report

- 1 Press .
- 2 Press All Settings.
- 3 Swipe up or down, or press ▲ or ▼ to display Print Reports.
- 4 Press Print Reports.
- 5 Press the report you want to print.
- 6 Press OK.
- 7 Press .

7

Making copies

Copy options

You can change the copy settings temporarily for the next copy.

The machine returns to its default settings after being idle for 1 minute.

Press **Copy** and then press **Options**. Swipe up or down, or press **▲** or **▼** to scroll through the copy settings. When the setting you want is displayed, press it and choose your preferred option. When you finished changing the options, press **OK** and then press **Mono Start** or **Colour Start**.

NOTE

- You can save some of the options you use most often by setting them as a Shortcut. (See *Saving copy options as a Shortcut* on page 47.)
- The Ink Save Mode, Thin Paper Copy, Book Copy and Watermark Copy features are supported by technology from Reallusion,

Inc.  **REALLUSION**

Stop copying

To stop copying, press .

Changing copy speed and quality

You can choose from the speed and quality. The factory default is **Normal**.

■ Normal

Normal is the recommended mode for ordinary print outs. This produces good copy quality with good copy speed.

NOTE

If you choose **Normal**, you can only choose **Plain Paper** in **Paper Type**.

■ Best

Use **Best** mode to copy precise images such as photographs. This provides the highest resolution and slowest speed.

- 1 Load your document.
- 2 Press **Copy**.
- 3 Enter the number of copies you want.
- 4 Press **Options**.
- 5 Swipe up or down, or press **▲** or **▼** to display **Quality**.
- 6 Press **Quality**.
- 7 Press **Normal** or **Best**.
- 8 Press **OK**.
- 9 If you do not want to change additional settings, press **Mono Start** or **Colour Start**.

Enlarging or reducing the copied image

You can choose an enlargement or reduction ratio. If you choose **Fit to Page**, your machine will adjust the size automatically to the paper size you set.

- 1 Load your document.
- 2 Press **Copy**.
- 3 Enter the number of copies you want.
- 4 Press **Options**.
- 5 Swipe up or down, or press **▲** or **▼** to display **Enlarge/Reduce**.
- 6 Press **Enlarge/Reduce**.
- 7 Swipe up or down, or press **▲** or **▼** to display the available options, and then press the option you want to change.
- 8 Do one of the following:
 - If you chose **Enlarge** or **Reduce**, press the enlargement or reduction ratio you want to use.
 - If you chose **Custom (25-400%)**, press **✕** to erase the displayed percentage, or press **◀** to move the cursor, and then enter an enlargement or reduction ratio from 25% to 400%.
Press **OK**.
 - If you chose **100%** or **Fit to Page**, go to step 9.

198% 10x15cm → A4
186% 10x15cm → Letter
141% A4→A3, A5→A4
100%
97% Letter → A4
93% A4 → Letter
83% Legal → A4
69% A4 → A5
47% A4 → 10x15cm
Fit to Page
Custom (25-400%)

- 9 Read and confirm the displayed list of options you have chosen, and then press **OK**.
- 10 If you do not want to change additional settings, press **Mono Start** or **Colour Start**.

NOTE

- Page Layout is not available with **Enlarge/Reduce**.
- Page Layout, 2-sided Copy, Book Copy, Sort, Thin Paper Copy, Watermark Copy and Remove Background Colour are not available with **Fit to Page**.
- **Fit to Page** does not work correctly when the document on the scanner glass is skewed more than 3 degrees. Using the document guidelines on the left and top, place your document in the upper-left hand corner, with the document face down on the scanner glass.
- **Fit to Page** is not available when using the **ADF**.
- **Fit to Page** is not available for **Legal** size documents.

Making N in 1 copies or a poster (Page Layout)

The N in 1 copy feature can help you save paper by letting you copy two or four pages onto one printed page.

You can also produce a poster. When you use the poster feature, your machine divides your document into sections, then enlarges the sections so you can assemble them into a poster. If you want to print a poster, use the scanner glass.

NOTE

- Book Copy, Sort, Thin Paper Copy, Ink Save Mode, Enlarge/Reduce, Watermark Copy and Remove Background Colour are not available with Page Layout.
- 2-sided Copy is not available with Poster copy.

- 1 Load your document.
- 2 Press `Copy`.
- 3 Enter the number of copies you want. ¹
¹ You can only make one copy at a time when you are using `Poster` layout.
- 4 Press `Options`.
- 5 Swipe up or down, or press ▲ or ▼ to display `Page Layout`.
- 6 Press `Page Layout`.
- 7 Swipe up or down, or press ▲ or ▼ to display `Off (1in1)`, `2in1 (Portrait)`, `2in1 (Landscape)`, `2in1 (ID)` ¹, `4in1 (Portrait)`, `4in1 (Landscape)`, `Poster (2x1)`, `Poster (2x2)` or `Poster (3x3)`. Press the option you want to set.

¹ For details about 2 in 1 (ID), see *2 in 1 ID Copy (Page Layout)* on page 41.

- 8 Read and confirm the displayed list of settings you have chosen, and then press `OK`.
- 9 If you do not want to change additional settings, press `Mono Start` or `Colour Start` to scan the page. If you placed the document in the ADF or are making a poster, the machine scans the document and starts printing.

If you are using the scanner glass, go to step 10.

- 10 After the machine has scanned the page, press `Yes` to scan the next page.
- 11 Place the next page on the scanner glass. Press `OK` to scan the page. Repeat steps 10 and 11 for each page of the layout.
- 12 After all the pages have been scanned, press `No` to finish.

NOTE

- Make sure the paper size is set to A4, A3, Letter or Ledger.
- You can only make one colour copy at a time.
- You can only make one Poster copy at a time.
- Poster copy is not available when using transparencies.
- `2in1 (ID)`, `4in1 (Portrait)`, `4in1 (Landscape)`, `Poster (2x1)` and `Poster (3x3)` are not available when using Ledger or A3 size paper.

Place the document face down in the direction shown below:

■ 2in1 (Portrait)



■ 2in1 (Landscape)



■ 4in1 (Portrait)



■ 4in1 (Landscape)



■ Poster (2x1)

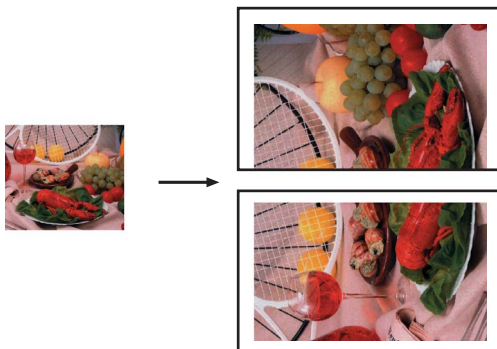

■ Poster (2x2)

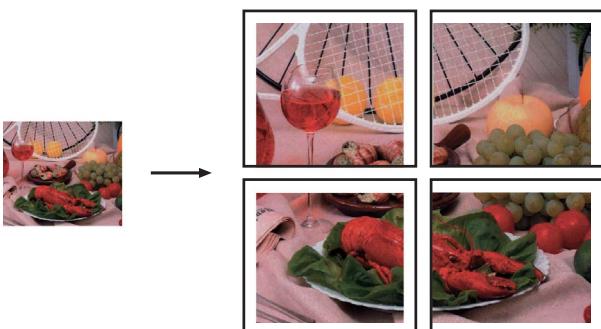

■ Poster (3x3)

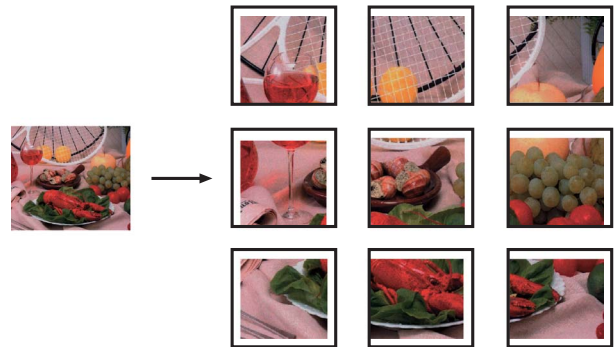

2 in 1 ID Copy (Page Layout)

You can copy both sides of your identification card onto one page, keeping the original card size. Make sure the paper size is set to A4 or Letter.

NOTE

You can copy an identification card to the extent permitted under applicable laws. (See Product Safety Guide: *Unlawful use of copying equipment.*)

- 1 Place your identification card *face down* near the left corner of the scanner glass as shown below.

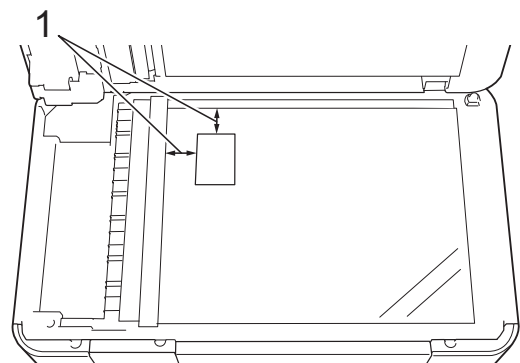

1 3 mm or greater (top, left)

- 2 Press Copy.
- 3 Enter the number of copies you want.
- 4 Press Options.

- 5 Swipe up or down, or press ▲ or ▼ to display `Page Layout`.
- 6 Press `Page Layout`.
- 7 Swipe up or down, or press ▲ or ▼ to display `2in1 (ID)`.
- 8 Press `2in1 (ID)`.
- 9 Read and confirm the displayed list of settings you have chosen, and then press `OK`.
- 10 Press `Mono Start` or `Colour Start`. The machine starts scanning one side of the identification card.
- 11 After the machine has scanned one side, press `Yes`. Turn over the identification card and press `OK` to scan the other side.

NOTE

- `Book Copy`, `Sort`, `2-sided Copy`, `Thin Paper Copy`, `Ink Save Mode`, `Enlarge/Reduce`, `Watermark Copy` and `Remove Background Colour` are not available with `2in1 (ID)`.
- You can only make one colour copy at a time.

Sorting copies using the ADF

You can sort multiple copies. Pages will be sorted in the order 123, 123, 123, and so on.

- 1 Load your document.
- 2 Press `Copy`.
- 3 Enter the number of copies you want.
- 4 Press `Options`.
- 5 Swipe up or down, or press ▲ or ▼ to display `Stack/Sort`.
- 6 Press `Stack/Sort`.

- 7 Press `Sort`.
- 8 Read and confirm the displayed list of settings you have chosen, and then press `OK`.
- 9 If you do not want to change additional settings, press `Mono Start` or `Colour Start`.

NOTE

`Fit to Page`, `Page Layout` and `Book Copy` are not available with `Sort`.

Adjusting Density

You can adjust the copy density to make copies darker or lighter.

- 1 Load your document.
- 2 Press `Copy`.
- 3 Enter the number of copies you want.
- 4 Press `Options`.
- 5 Swipe up or down, or press ▲ or ▼ to display `Density`.
- 6 Press `Density`.
- 7 Press the level of density you want, from `Light` to `Dark`.
- 8 Read and confirm the displayed list of settings you have chosen, and then press `OK`.
- 9 If you do not want to change additional settings, press `Mono Start` or `Colour Start`.

Ink Save Mode

Ink Save Mode can help you save ink. The machine prints the colours lighter and emphasises the outlines of the images as shown below:

The amount of ink saved will vary depending on the document.

Ink Save Mode: Off

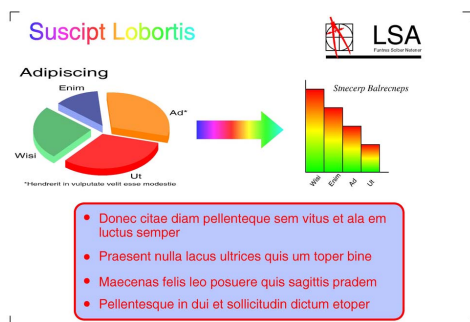

Ink Save Mode: On

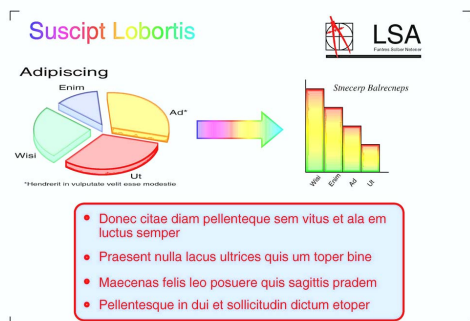

(The above screens are used in ISO/IEC 24712.)

- 1 Load your document.
- 2 Press Copy.
- 3 Enter the number of copies you want.
- 4 Press Options.
- 5 Swipe up or down, or press ▲ or ▼ to display Advanced Settings.
- 6 Press Advanced Settings.

- 7 Swipe up or down, or press ▲ or ▼ to display Ink Save Mode.
- 8 Press Ink Save Mode.
- 9 Read and confirm the displayed list of settings you have chosen, and then press OK.
- 10 If you do not want to change any additional settings, press Mono Start or Colour Start.

NOTE

- Book Copy, Thin Paper Copy, Page Layout, Watermark Copy and Remove Background Colour are not available with Ink Save Mode.
- Ink Save Mode may make your printouts look different from your original document.

7

Thin Paper Copy

If your document is a 2-sided Copy on thin paper, choose Thin Paper Copy so the print on the other side does not bleed through.

- 1 Load your document.
- 2 Press Copy.
- 3 Enter the number of copies you want.
- 4 Press Options.
- 5 Swipe up or down, or press ▲ or ▼ to display Advanced Settings.
- 6 Press Advanced Settings.
- 7 Swipe up or down, or press ▲ or ▼ to display Thin Paper Copy.
- 8 Press Thin Paper Copy.
- 9 Read and confirm the displayed list of settings you have chosen, and then press OK.

- 10 Press **Mono Start** or **Colour Start**.

NOTE

Fit to Page, Page Layout, Ink Save Mode, Book Copy, Watermark Copy and Remove Background Colour are not available with Thin Paper Copy.

Book Copy

Book Copy corrects dark borders and skew when copying from the scanner glass. Your machine can correct the data automatically.

- 1 Load your document.
- 2 Press **Copy**.
- 3 Enter the number of copies you want.
- 4 Press **Options**.
- 5 Swipe up or down, or press ▲ or ▼ to display **Advanced Settings**.
- 6 Press **Advanced Settings**.
- 7 Swipe up or down, or press ▲ or ▼ to display **Book Copy**.
- 8 Press **Book Copy**.
- 9 Read and confirm the displayed list of settings you have chosen, and then press **OK**.
- 10 If you do not want to change additional settings, press **Mono Start** or **Colour Start**.

NOTE

Page Layout, Sort, 2-sided Copy, Ink Save Mode, Fit to Page, Thin Paper Copy, Watermark Copy and Remove Background Colour are not available with Book Copy.

Watermark Copy

You can place text into your document as a Watermark. You can select one of the template watermarks.

NOTE

Fit to Page, Page Layout, Thin Paper Copy, Ink Save Mode, Book Copy and Remove Background Colour are not available with Watermark Copy.

Using a template

- 1 Load your document.
- 2 Press **Copy**.
- 3 Enter the number of copies you want.
- 4 Press **Options**.
- 5 Swipe up or down, or press ▲ or ▼ to display **Advanced Settings**.
- 6 Press **Advanced Settings**.
- 7 Swipe up or down, or press ▲ or ▼ to display **Watermark Copy**.
- 8 Press **Watermark Copy**.
- 9 Change the watermark settings by pressing the options displayed on the Touchscreen as required. (For details, see *Watermark Copy Settings* on page 45.) Press **OK**.
- 10 Press **OK** to confirm to use the watermark.
- 11 Press **Mono Start** or **Colour Start**.

Watermark Copy Settings

Option1	Option2	Option3
Watermark Copy	Text	CONFIDENTIAL* DRAFT COPY IMPORTANT URGENT
	Position	A B C D E* F G H I Pattern
	Size	Small Medium* Large
	Angle	-90° -45°* 0° 45° 90°
	Transparency	-2 -1 0* +1 +2
	Colour	Black* Green Blue Purple Red Orange Yellow
The default settings are shown in Bold with an asterisk.		

Remove Background Colour

Remove Background Colour removes the background colour of the document when copying. This can save ink and help you read the document clearly.

NOTE

This function is for use only when making colour copies. The background colour is automatically removed for all monochrome copies.

- 1 Load your document.
- 2 Press Copy.
- 3 Enter the number of copies you want.
- 4 Press Options.
- 5 Swipe up or down, or press ▲ or ▼ to display Advanced Settings.
- 6 Press Advanced Settings.
- 7 Swipe up or down, or press ▲ or ▼ to display Remove Background Colour.
- 8 Press Remove Background Colour.
- 9 Press Low, Medium or High.
- 10 Press OK.
- 11 Press Colour Start.

NOTE

Fit to Page, Page Layout, Ink Save Mode, Thin Paper Copy, Book Copy and Watermark Copy are not available with Remove Background Colour.

2-sided copying

You can reduce the amount of paper used for copies by copying on both sides of the paper.

We recommend you load single-sided documents in the ADF for 2-sided copying. For 2-sided documents and books, use the scanner glass.

(Long edge flip)

Portrait

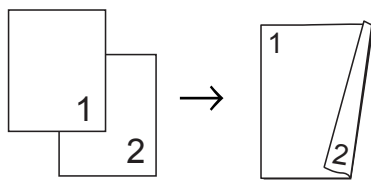

Landscape

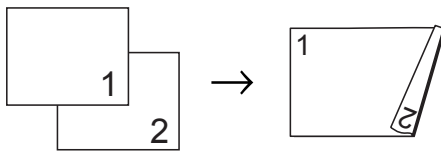

(Short edge flip)

Portrait

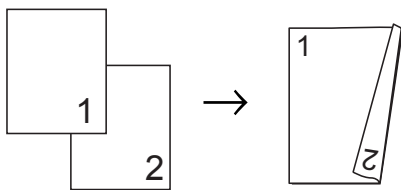

Landscape

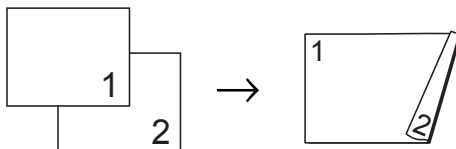

NOTE

- 2in1 (ID), Poster, Book Copy and Fit to Page are not available with 2-sided Copy.
- You can use only A4, A5 or Letter size plain paper.

- 1 Load your document.
- 2 Press Copy.
- 3 Enter the number of copies you want.
- 4 Press Options.
- 5 If you want to sort multiple copies, swipe up or down, or press ▲ or ▼ to display Stack/Sort.
- 6 Press Stack/Sort.
- 7 Press Sort.
- 8 Swipe up or down, or press ▲ or ▼ to display 2-sided Copy.
- 9 Press 2-sided Copy.
- 10 Swipe up or down, or press ▲ or ▼ to display the 2-sided copy type you want, and press
Portrait Long Edge Flip,
Landscape Long Edge Flip,
Portrait Short Edge Flip or
Landscape Short Edge Flip.
- 11 Read and review the message on the Touchscreen, and then press OK.
- 12 Review your settings on the Touchscreen, and then press OK.
- 13 Press Mono Start or Colour Start. If you placed the document in the ADF, the machine scans the pages and starts printing.

If you are using the scanner glass, go to step 14.

14 The Touchscreen shows:

Turn over the document (or Flip the book), then press [Scan]. When you finish, press [Complete].

Place the next page on the scanner glass and press Scan.

Press OK.

The machine starts printing.

15 If you pressed Sort for multiple copies, repeat step 14 for each additional page. After all the pages have been scanned, press Complete.

The machine starts printing.

DO NOT touch printed pages until they are ejected the second time. The machine will print and eject the first side, and then pull the paper back in to print the second side.

NOTE

If your document causes paper jams, try using one of the special 2-sided copy settings. Press Advanced after step 9, and then choose 2-sided 1 or 2-sided 2.

2-sided 1 helps avoid paper jams when copying by allowing more time for the ink to dry. Choosing 2-sided 2 allows more time for the ink to dry while also using less ink.

Saving copy options as a Shortcut

You can store the copy options you use frequently by saving them as a Shortcut.

- 1 Press Copy.
- 2 Press Options.
- 3 Swipe up or down, or press ▲ or ▼ to display Quality, Paper Type, Paper Size, Enlarge/Reduce, Density, Stack/Sort, Page Layout, 2-sided Copy or Advanced Settings, and then press the setting you want to change. Then press the new option you want. Repeat this step for each setting you want to change.
- 4 When you have finished choosing new options, press Save as Shortcut.
- 5 Read and confirm the displayed list of options you have chosen for the Shortcut, and then press OK.
- 6 Enter a name for the Shortcut using the keyboard on the Touchscreen. (To help you enter letters, see Basic User's Guide: *Entering Text*.) Press OK.
- 7 Press OK to save your Shortcut.

A3 Copy Shortcuts

A3 Copy Shortcut

You can copy your document in A3 or Ledger size paper with a format such as Note style. Also you can make 2 in 1 and enlarged copies.

■ A3 2in1

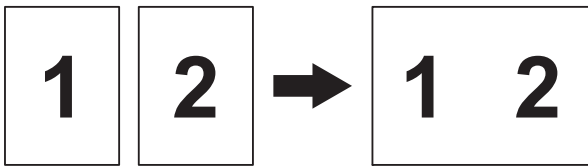

■ A4 + Note (L)

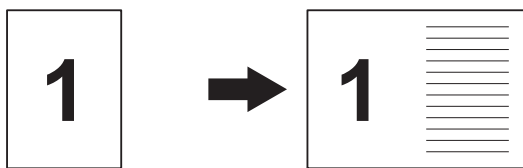

■ A4 + Note (P)

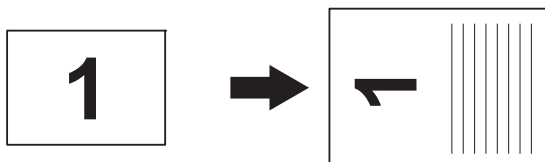

■ A4 + Grid

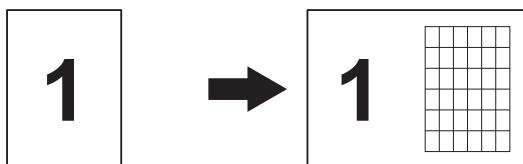

■ A4 + Blank

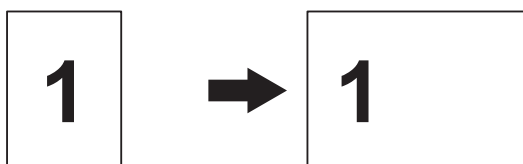

■ A4 Centre

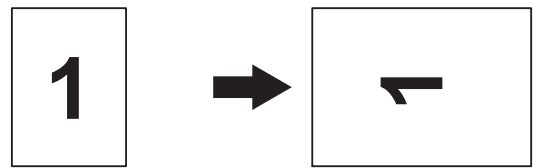

■ A4 → A3

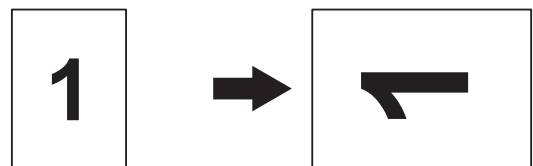

NOTE

- You can use only A3 or Ledger size plain paper.
- If you are producing multiple colour copies, A3 2in1, A4 + Note (L), A4 + Note (P), A4 + Grid and A4 + Blank are not available.
- (P) means Portrait and (L) means Landscape.
- You can enlarge a copy only when using A4 → A3.

- 1 Load your document.
- 2 If the displayed screen is either Home or Shortcut, swipe left or right, or press ◀ or ▶ to display the More screen.
- 3 Press A3 Copy Shortcuts.
- 4 If information appears on the Touchscreen, read it and then press OK to confirm it.
Load A3 or Ledger size paper according to the on-screen instructions.
- 5 Swipe left or right to display A3 2in1, A4 → A3, A4 + Note (L), A4 + Note (P), A4 + Grid, A4 + Blank or A4 Centre, and then press the option you want.
Press OK.

- 6 Enter the number of copies you want.
- 7 Do one of the following:
 - If you want to change more settings, go to step 8.
 - If you do not want to change further settings, go to step 12.
- 8 Press `Options`.
- 9 Press the setting you want to change.
- 10 Press your new option.

Repeat steps 9 and 10 to change other settings as required.
- 11 Press `OK` when you have finished changing options.
- 12 Press `Mono Start` or `Colour Start`.

If you are using the scanner glass when choosing A3 2in1, go to step 16.

- 13 After the machine has scanned the page, press `Yes` to scan the next page.
- 14 Place the next page on the scanner glass. Press `OK` to scan the page. Repeat steps 13 and 14 for each page of the layout.
- 15 After all the pages have been scanned, press `No` to finish.

PhotoCapture Center™ operations

Memory cards, USB Flash memory drive and folder structures

Your machine is designed to be compatible with modern digital camera image files, memory cards and USB Flash memory drives; however, please read the points below to avoid errors:

- The image file extension must be .JPG (other image file extensions like .JPEG, .TIF, .GIF and so on will not be recognized).
- Direct PhotoCapture Center™ printing must be performed separately from PhotoCapture Center™ operations using the PC. (Simultaneous operation is not available.)
- The machine can read up to 999 files ¹ on a memory card or USB Flash memory drive.

¹ The folder inside memory cards or USB Flash memory drive is also counted.
- The DPOF file on the memory cards must be in a valid DPOF format. (See *DPOF printing* on page 55.)

Please be aware of the following:

- When printing an index or image, the PhotoCapture Center™ will print all the valid images, even if one or more images have been corrupted. Corrupted images will not be printed.

■ (memory card users)

Your machine is designed to read memory cards that have been formatted by a digital camera.

When a digital camera formats a memory card, it creates a special folder into which it copies image data. If you need to modify the image data stored on a memory card with your PC, we recommend that you do not modify the folder structure created by the digital camera. When saving new or modified image files to the memory card, we also recommend you use the same folder your digital camera uses. If the data is not saved to the same folder, the machine may not be able to read the file or print the image.

■ (USB Flash memory drive users)

This machine supports USB Flash memory drives that have been formatted by Windows®.

Movie printing

You can print images from movie files that are stored on a memory card or USB Flash memory drive.

Movie files are automatically split by duration into 9 parts, and placed in 3 rows so you can see and print the scenes.

NOTE

- You cannot choose a particular movie scene.
- You can use AVI or MOV movie file formats (Motion JPEG only). However, if an AVI file size is 1 GB or more (the shooting time is about 30 minutes) or a MOV file size is 2 GB or more (the shooting time is about 60 minutes), these files cannot be printed.
- If the data for a divided scene is corrupted, the part for that scene will be blank.

Print Images

Print Index (Thumbnails)

The PhotoCapture Center™ assigns numbers for images (such as No.1, No.2, No.3, and so on).



→ NO. 1
DEI.JPG 01. 01. 2009
100KB

The PhotoCapture Center™ uses these numbers to identify each picture. You can print a thumbnail page to show all the pictures on the memory card or USB Flash memory drive.

NOTE

Only file names that are 20 characters or less will be printed correctly on the index sheet.

- 1 Open the media slot cover.
- 2 Put the memory card or USB Flash memory drive in the correct slot.
- 3 Press **Photo**.
- 4 Swipe left or right to display **Index Print**.
- 5 Press **Index Print**. Press **OK**.
- 6 Press **Print Index Sheet**.
- 7 Do one of the following:
 - Press **Print Settings** to change the paper type or the paper size you are using. Go to step 8.
 - If you do not want to change the paper settings, press **Start**.

- 8 Press **Paper Type**.
- 9 Press **Plain Paper, Inkjet Paper, Brother BP71 or Other Glossy**.
- 10 Press **Paper Size**.
- 11 Press **A4 or Letter**.
- 12 Press **OK**.
- 13 Press **Start** to print.

Printing Photos

Before you can print an individual image, you have to know the image number.

- 1 Open the media slot cover.
- 2 Put the memory card or USB Flash memory drive in the correct slot.
- 3 Press **Photo**.
- 4 Print the Index. (See *Print Index (Thumbnails)* on page 51.)
- 5 Swipe left or right to display **Index Print**.
- 6 Press **Index Print**. Press **OK**.
- 7 Press **Print Photos Using Index No.**
- 8 Enter the image number that you want to print from the thumbnails printed on the Index page. After you have chosen the image numbers, press **OK**.

NOTE

- You can enter the numbers at one time by using a comma or a hyphen. For example, Enter 1,3,6 to print images No.1, No.3 and No.6. Enter 1-5 to print images No.1 to No.5.
- You can enter up to 12 characters (including commas and hyphens) for the image numbers you want to print.

- 9 Do one of the following:
 - Press **Print Settings** to change the print settings. (See page 55.)
 - If you do not want to change any settings, press **Start** to print.

Enhance Photos

You can edit and add effects to your photos and view them on the Touchscreen before printing.

NOTE

The **Enhance Photos** feature is supported by technology from Reallusion, Inc.  **REALLUSION**

- 1 Open the media slot cover.
- 2 Put the memory card or USB Flash memory drive in the correct slot.
- 3 Press **Photo**.
- 4 Swipe left or right to display **Enhance Photos**.
- 5 Press **Enhance Photos**. Press **OK**.



NOTE







- Eight thumbnails are displayed at a time with the current page number and total number of pages listed above the thumbnails.
- Swipe left or right, or press ◀ or ▶ repeatedly to select each page of photos, or hold down to scroll through all pages of photos.

- 6 Press a photo from the thumbnails.
- 7 Press Enhance, Crop or Enhance and Crop.
- 8 Do one of the following:
 - If you chose Enhance or Enhance and Crop, go to step 9.
 - If you chose Crop, go to step 10.
- 9 Press the effect you wish to add. Press OK. Do one of the following:
 - If you chose Enhance in step 8, go to step 11.
 - If you chose Enhance and Crop in step 8, go to step 10.

NOTE

- You have 10 ways to add effects to your photo.

	(Auto Correct) The machine decides the suitable effect for your photo.
	(Enhance Skin) Best used for adjusting portrait photographs. It adjusts human skin colour. Press ◀ or ▶ to adjust the level of contrast.
	(Enhance Scenery) Best used for adjusting landscape photographs. It highlights green and blue areas in your photo. Press ◀ or ▶ to adjust the level of contrast.

	(Remove Red-Eye) The machine will attempt to remove red-eye from your photo. If red-eye detection fails, you can press Try Again to re-detect.
	(Night Scene) Night Scene is best used for adjusting night view photographs to make them more vivid. Press ◀ or ▶ to adjust the level of contrast.
	(Fill Light) Fill Light is best used for adjusting photographs against the light. Press ◀ or ▶ to adjust the level of contrast.
	(Whiteboard) Whiteboard is best used for adjusting photographs. It detects letters on a whiteboard in your photo and makes them more legible.
	(Monochrome) You can convert your photo to monochrome.
	(Sepia) You can convert the colour of your photo to sepia.
	(Auto Correct & Remove Red-Eye) The machine decides the suitable effects for your photo. It will also attempt to remove red-eye from your photo.

- There are some cases when red-eye may not be removed.
 - When the face is too small in the image.
 - When the face is turning too far up, down, left or right.
- Press Cancel to return to the list of effects.
- If your photo is very small or has irregular proportions, you may not be able to crop or enhance the photo. The Touchscreen will display Image Too Small or Image Too Long.

- 10 Adjust the red frame around your photo. The part inside of the red frame will be printed.

- Press **+** or **-** to enlarge or reduce the frame size.
- Press **▲**, **▼**, **◀** or **▶** to move the position of the frame.
- Press  to rotate the frame.

Press **OK** when you have finished adjusting the frame setting.
Press **OK** to confirm.

NOTE

If your photo is very small or of irregular proportions, you may not be able to crop or enhance the photo. The Touchscreen will display *Image Too Small* or *Image Too Long*.

- 11 Enter the number of copies you want, either by pressing **+** or **-** or using the dial pad on the Touchpanel.
Press **OK**.
- 12 Do one of the following.
- Press **Print Settings** to change the print settings. (See page 55.)
 - If you do not want to change any settings, press **Start** to print.

Slide Show

You can view all your photos on the Touchscreen using **Slide Show**. You can also choose a photo during the operation.

- 1 Open the media slot cover.
- 2 Put the memory card or USB Flash memory drive in the correct slot.
- 3 Press **Photo**.
- 4 Swipe left or right to display **Slide Show**.

- 5 Press **Slide Show**.
Press **OK**.

- 6 Do one of the following:
- If you want to change the time to show each photo, press **Show Each Photo for**.
Swipe up or down, or press **▲** or **▼** to display **3Secs**, **10Secs**, **30Secs**, **1Min** or **5Mins**, and then press the option you want to set.
 - If you want to change the effect, press **Effect**.
Press **Slide In**, **Fade In**, **Zoom In** or **Off**.
 - If you do not want to change the settings, press **Start**.

- 7 Press  to finish **Slide Show**.

Printing a photo during a Slide Show

- 1 To print an image during a slide show, press the image when it appears on the Touchscreen.
- 2 Enter the number of copies you want using the dial pad on the Touchpanel.
- 3 Do one of the following:
 - Press **Print Settings** to change the print settings. (See *PhotoCapture Center™ print settings* on page 55.)
 - If you do not want to change any settings, press **Start** to print.

DPOF printing

DPOF stands for Digital Print Order Format.

Major digital camera manufacturers (Canon Inc., Eastman Kodak Company, FUJIFILM Corporation, Panasonic Corporation and Sony Corporation) created this standard to make it easier to print images from a digital camera.

If your digital camera supports DPOF printing, you will be able to choose the images and the number of copies you want to print on the display of the digital camera.

When a memory card containing DPOF information is put into your machine, you can print the chosen image easily.

- 1 Open the media slot cover.
- 2 Put the memory card or USB Flash memory drive in the correct slot. The DPOF file on the memory card or USB Flash memory drive must be in a valid DPOF format.
- 3 Press `DPOF`.
- 4 Do one of the following:
 - Press `Print Settings` to change the print settings. (See page 55.)
 - If you do not want to change any settings, press `Start` to print.

NOTE

A DPOF File error can occur if the print order that was created on the camera has been corrupted. Delete and recreate the print order using your camera to correct this problem. For instructions on how to delete or recreate the print order, refer to your camera manufacturer's support website or accompanying documentation.

PhotoCapture Center™ print settings

You can change the print settings temporarily for the next print job.

The machine returns to its default settings after being idle for 1 minute.

NOTE

You can save the print settings you use most often by setting them as the default settings. (See *Setting your changes as a new default* on page 61.)



Print Quality

- 1 Open the media slot cover.
- 2 Put the memory card or USB Flash memory drive in the correct slot.
- 3 Press `Photo`.
- 4 Swipe left or right to display `View Photos`.
- 5 Press `View Photos`. Press `OK`.
- 6 Swipe left or right, or press `◀` or `▶` to display each photo. When the photo you want is displayed, press it and then press `OK`.
- 7 Press `OK`.
- 8 Press `Print Settings`.

- 9 Swipe up or down, or press ▲ or ▼ to display `Print Quality`.
- 10 Press `Print Quality`.
- 11 Press `Normal` or `Photo`.
- 12 If you do not want to change additional settings, press ⏪ or OK. Press `Start` to print.

NOTE

If you choose `Inkjet Paper` in `Paper Type`, you can only choose `Photo`.

Paper options

Paper Type







- 1 Open the media slot cover.
- 2 Put the memory card or USB Flash memory drive in the correct slot.
- 3 Press `Photo`.
- 4 Swipe left or right to display `View Photos`.
- 5 Press `View Photos`. Press OK.
- 6 Swipe left or right, or press ◀ or ▶ to display each photo. When the photo you want is displayed, press it and then press OK.
- 7 Press OK.
- 8 Press `Print Settings`.
- 9 Swipe up or down, or press ▲ or ▼ to display `Paper Type`.
- 10 Press `Paper Type`.
- 11 Press `Plain Paper`, `Inkjet Paper`, `Brother BP71` or `Other Glossy`.
- 12 If you do not want to change additional settings, press ⏪ or OK. Press `Start` to print.

Paper Size and Print Size

- 1 Open the media slot cover.
- 2 Put the memory card or USB Flash memory drive in the correct slot.
- 3 Press `Photo`.
- 4 Swipe left or right to display `View Photos`.
- 5 Press `View Photos`. Press OK.
- 6 Swipe left or right, or press ◀ or ▶ to display each photo. When the photo you want is displayed, press it and then press OK.
- 7 Press OK.
- 8 Press `Print Settings`.
- 9 Swipe up or down, or press ▲ or ▼ to display `Paper Size`.
- 10 Press `Paper Size`.

- 11** Swipe up or down, or press ▲ or ▼ to display 10x15cm, 13x18cm, A4, A3, Letter or Ledger. Press the option you want to set. Do one of the following:
- If you chose A4 or Letter, go to step 12.
 - If you chose 10x15cm or 13x18cm, go to step 13.
 - If you chose A3 or Ledger, the Touchscreen will prompt you to put the paper in the manual feed slot. Read the information on the Touchscreen, and then confirm it by pressing OK. (See Basic User's Guide: *Loading paper in the manual feed slot.*)
- Go to step 13.

- 12** Press Print Size. Swipe up or down, or press ▲ or ▼ to display the options in the following table, and then press the option you want to set.

Example: Printed position for A4 size paper		
1 8x10cm	2 9x13cm	3 10x15cm
		
4 13x18cm	5 15x20cm	6 Max. Size
		

- 13** If you do not want to change additional settings, press ↵ or OK. Press Start to print.

Adjusting Brightness, Contrast and Colour

Brightness

- 1 Open the media slot cover.
- 2 Put the memory card or USB Flash memory drive in the correct slot.
- 3 Press Photo.
- 4 Swipe left or right to display View Photos.
- 5 Press View Photos. Press OK.
- 6 Swipe left or right, or press ◀ or ▶ to display each photo. When the photo you want is displayed, press it and then press OK.
- 7 Press OK.
- 8 Press Print Settings.
- 9 Swipe up or down, or press ▲ or ▼ to display Brightness.
- 10 Press Brightness.
- 11 Adjust the level of brightness by pressing it on the Touchscreen.
- 12 If you do not want to change additional settings, press ↵ or OK. Press Start to print.

Contrast



You can choose the contrast setting. Increasing the contrast will make an image look sharper and more vivid.

- 1 Open the media slot cover.
- 2 Put the memory card or USB Flash memory drive in the correct slot.
- 3 Press `Photo`.
- 4 Swipe left or right to display `View Photos`.
- 5 Press `View Photos`. Press `OK`.
- 6 Swipe left or right, or press ◀ or ▶ to display each photo. When the photo you want is displayed, press it and then press `OK`.
- 7 Press `OK`.
- 8 Press `Print Settings`.
- 9 Swipe up or down, or press ▲ or ▼ to display `Contrast`.
- 10 Press `Contrast`.
- 11 Adjust the level of contrast by pressing it on the Touchscreen.
- 12 If you do not want to change additional settings, press  or `OK`. Press `Start` to print.

Colour Enhancement

You can turn on the colour enhancement feature to print more vivid images. Printing time will be slower with this feature and also, depending on the image you are printing, it may use more ink.

- 1 Open the media slot cover.
- 2 Put the memory card or USB Flash memory drive in the correct slot.
- 3 Press `Photo`.
- 4 Swipe left or right to display `View Photos`.
- 5 Press `View Photos`. Press `OK`.
- 6 Swipe left or right, or press ◀ or ▶ to display each photo. When the photo you want is displayed, press it and then press `OK`.
- 7 Press `OK`.
- 8 Press `Print Settings`.
- 9 Swipe up or down, or press ▲ or ▼ to display `Colour Enhance`.
- 10 Press `Colour Enhance`.
- 11 Do one of the following:
 - If you want to customize the `White Balance`, `Sharpness` or `Colour Density`, press `Colour Enhance` and then press `On`. Go to step 12.
 - If you do not want to customize, press `Colour Enhance` and then press `Off`. Press . Go to step 15.
- 12 Press `White Balance`, `Sharpness` or `Colour Density`.

- 13 Press ◀ or ▶ to adjust the degree of the setting.
Press OK.
- 14 Do one of the following:
 - If you want to customize another colour enhancement, repeat steps 12 and 13.
Press .
 - If you want to change other settings, press  to display the print setting menu and press the setting you want to change. (See page 55.)
- 15 If you do not want to change additional settings, press  or OK.
Press Start to print.

NOTE

• White Balance

This setting adjusts the hue of the white areas of an image. Lighting, camera settings and other influences will affect the appearance of white. The white areas of a picture may be slightly pink, yellow or some other colour. By using this setting, you can correct that effect and bring the white areas back to pure white.

• Sharpness

This setting enhances the detail of an image, similar to adjusting the fine focus on a camera. If the image is not in true focus and you cannot see the fine details of the picture, then adjust the sharpness.

• Colour Density

This setting adjusts the total amount of colour in the image. You can increase or decrease the amount of colour in an image to improve a washed out or weak picture.

Cropping

If your photo is too long or too wide to fit the available space on your chosen layout, part of the image will automatically be cropped.

The default setting is On. If you want to print the whole image, change this setting to Off. If you set Cropping to Off, also set Borderless to Off. (See *Borderless printing* on page 60.)

- 1 Open the media slot cover.
- 2 Put the memory card or USB Flash memory drive in the correct slot.
- 3 Press Photo.
- 4 Swipe left or right to display View Photos.
- 5 Press View Photos.
Press OK.
- 6 Swipe left or right, or press ◀ or ▶ to display each photo. When the photo you want is displayed, press it and then press OK.
- 7 Press OK.
- 8 Press Print Settings.
- 9 Swipe up or down, or press ▲ or ▼ to display Cropping.
- 10 Press Cropping.
- 11 Press Off (or On).
- 12 If you do not want to change additional settings, press  or OK.
Press Start to print.

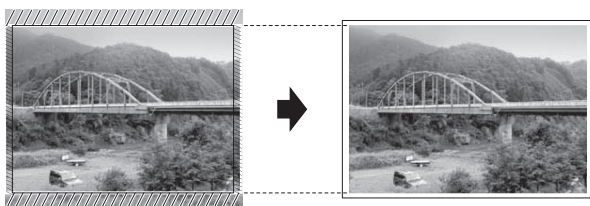
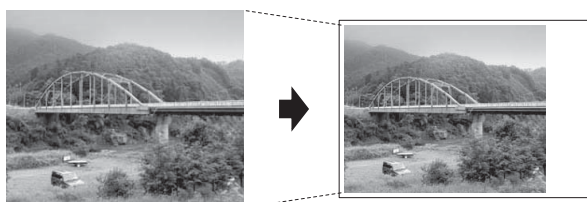
Cropping: On**Cropping: Off**

Borderless printing

This feature expands the printable area to the edges of the paper. Printing time will be slightly slower.

- 1 Open the media slot cover.
- 2 Put the memory card or USB Flash memory drive in the correct slot.
- 3 Press **Photo**.
- 4 Swipe left or right to display **View Photos**.
- 5 Press **View Photos**. Press **OK**.
- 6 Swipe left or right, or press ◀ or ▶ to display each photo. When the photo you want is displayed, press it and then press **OK**.
- 7 Press **OK**.
- 8 Press **Print Settings**.
- 9 Swipe up or down, or press ▲ or ▼ to display **Borderless**.
- 10 Press **Borderless**.
- 11 Press **Off (or On)**.

- 12 If you do not want to change additional settings, press ⏪ or **OK**. Press **Start** to print.

Date Print

You can print the date if it is already in the data on your photo. The date will be printed on the lower-right corner. If the data doesn't have the date information, you cannot use this function.

- 1 Open the media slot cover.
- 2 Put the memory card or USB Flash memory drive in the correct slot.
- 3 Press **Photo**.
- 4 Swipe left or right to display **View Photos**.
- 5 Press **View Photos**. Press **OK**.
- 6 Swipe left or right, or press ◀ or ▶ to display each photo. When the photo you want is displayed, press it and then press **OK**.
- 7 Press **OK**.
- 8 Press **Print Settings**.
- 9 Swipe up or down, or press ▲ or ▼ to display **Date Print**.
- 10 Press **Date Print**.
- 11 Press **On (or Off)**.
- 12 If you do not want to change additional settings, press ⏪ or **OK**. Press **Start** to print.

NOTE

The DPOF setting on your camera must be turned off to use the **Date Print** feature.

Setting your changes as a new default

You can save the print settings you use most often by setting them as the default settings, such as Print Quality, Paper Type, Paper Size, Print Size, Auto Correct, Brightness, Contrast, Colour Enhance, Cropping, Borderless and Date Print. These settings will remain until you change them again.

- 1 Open the media slot cover.
- 2 Put the memory card or USB Flash memory drive in the correct slot.
- 3 Press Photo.
- 4 Swipe left or right to display View Photos.
- 5 Press View Photos.
Press OK.
- 6 Swipe left or right, or press ◀ or ▶ to display each photo. When the photo you want is displayed, press it and then press OK.
- 7 Press OK.
- 8 Press Print Settings.
- 9 Press your new setting.
Repeat this step for each setting you want to change.
- 10 After changing the last setting, swipe up or down, or press ▲ or ▼ to display Set New Default.
- 11 Press Set New Default.
- 12 The Touchscreen asks you to confirm the change to the new default settings. Press Yes to confirm.
- 13 Press .

Restoring all settings to the factory default

You can restore the PhotoCapture settings you have changed back to the factory default for, Print Quality, Paper Type, Paper Size, Print Size, Auto Correct, Brightness, Contrast, Colour Enhance, Cropping, Borderless and Date Print.

- 1 Open the media slot cover.
- 2 Put the memory card or USB Flash memory drive in the correct slot.
- 3 Press Photo.
- 4 Swipe left or right to display View Photos.
- 5 Press View Photos.
Press OK.
- 6 Swipe left or right, or press ◀ or ▶ to display each photo. When the photo you want is displayed, press it and then press OK.
- 7 Press OK.
- 8 Press Print Settings.
- 9 Swipe up or down, or press ▲ or ▼ to display Factory Reset.
- 10 Press Factory Reset.
- 11 The Touchscreen asks you to confirm to change back to the factory default. Press Yes to confirm.
- 12 Press .

Scan to a memory card or USB Flash memory drive

Auto Crop

You can scan multiple documents placed on the scanner glass. An individual document can be previewed on the Touchscreen before you save it. When you choose *Auto Crop*, the machine will scan each document and create separate files. For example, if you place three documents on the scanner glass, the machine will scan and create three separate files. If you want to create a three-page file, choose *PDF* or *TIFF* for *File Type*.

(If you choose *JPEG*, the three documents are created as three separate files.)

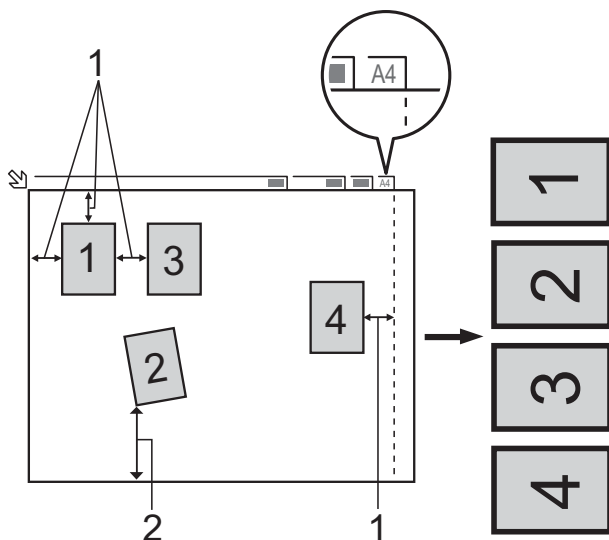

1 10 mm or greater (top, left, right)

2 20 mm or greater (bottom)

NOTE

Auto Crop is supported by technology from Reallusion, Inc.



- 1 Open the media slot cover.

- 2 Put the memory card or USB Flash memory drive in the correct slot.
- 3 Press *Scan to Media*.
- 4 Load your document.
- 5 Press *Options*.
- 6 Swipe up or down, or press ▲ or ▼ to display *Auto Crop*.
- 7 Press *Auto Crop*.
- 8 Press *On*.
- 9 Press *OK*.
- 10 If you do not want to change additional settings, press *Start* to start scanning.
- 11 The number of the scanned documents appears on the Touchscreen. Press *OK* to confirm.
- 12 Press ◀ or ▶ to preview the data for each document.
- 13 Press *Save All* to save the data.

NOTE

- **Auto Crop** is available for paper with right angles of 90 degrees at all four corners. If one of the angles is not square, **Auto Crop** cannot detect the document.
- If your document is too long or wide, this setting does not work correctly. The document has to meet the following specification: up to 195 × 270 mm.

If the ratio between the height and width of the document is more than 1 to 8, this setting does not work correctly.

- You must place the documents away from the edges of the scanner glass as shown in the illustration.
- You must place the documents at least 10 mm apart from each other.
- **Auto Crop** adjusts the skew of the document on the scanner glass, but if your document is skewed more than 10 degrees, this setting will not work.
- The ADF must be empty to use the **Auto Crop**.
- The **Auto Crop** feature is available for up to a maximum of 16 documents depending on the size of your documents.

IMPORTANT

DO NOT take out the memory card or USB Flash memory drive while the machine is reading or writing to the memory card or USB Flash memory drive to avoid damaging the card, USB Flash memory drive, or the data stored on them.

How to set a new default

You can save the **Scan to Media** settings (**Scan Type**, **Resolution**, **File Type**, **Auto Crop** and **Remove Background Colour**) you use most often by setting them as the default settings. These settings will remain until you change them again.

- 1 Open the media slot cover.
- 2 Put the memory card or USB Flash memory drive in the correct slot.
- 3 Press **Scan to Media**.
- 4 Press **Options**.
- 5 Swipe up or down, or press ▲ or ▼ to display **Scan Type**, **Resolution**, **File Type**, **Auto Crop** or **Remove Background Colour**, and then press the setting you want to change. Then press the option you want to change. Repeat this step for each setting you want to change.
- 6 After you are finished choosing your preferred settings, swipe up or down, or press ▲ or ▼ to display **Set New Default**.
- 7 Press **Set New Default**.
- 8 The Touchscreen asks you to confirm the change to the new default settings. Press **Yes** to confirm.
- 9 Press .

How to reset to the factory default

You can restore all the Scan to Media settings (Scan Type, Resolution, File Type, Auto Crop and Remove Background Colour), that you have changed, back to the factory default.

- 1 Open the media slot cover.
- 2 Put the memory card or USB Flash memory drive in the correct slot.
- 3 Press Scan to Media.
- 4 Press Options.
- 5 Swipe up or down, or press ▲ or ▼ to display Factory Reset.
- 6 Press Factory Reset.
- 7 The Touchscreen asks you to confirm to change back to the factory default. Press Yes to confirm.
- 8 Press .

Saving scan options as a Shortcut

You can store the scan options you use frequently by saving them as a Shortcut. This section introduces how to add a Shortcut for Scan to Media.

- 1 Open the media slot cover.
- 2 Put the memory card or USB Flash memory drive in the correct slot.
- 3 Press Scan to Media.
- 4 Press Options.
- 5 Swipe up or down, or press ▲ or ▼ to display Scan Type, Resolution, File Type, File Name, Auto Crop or Remove Background Colour, and then press the setting you want to change. Then press the option you want to set. Repeat this step for each setting you want to change.
- 6 When you have finished choosing new options, press OK.
- 7 Press Save as Shortcut.
- 8 Confirm the displayed list of settings you have chosen for the Shortcut, and then press OK.
- 9 Enter a name for the Shortcut using the keyboard on the Touchscreen. (To help you enter letters, see Basic User's Guide: *Entering Text*.) Press OK.
- 10 Press OK to save your Shortcut.

Printing photos directly from a PictBridge camera



Your Brother machine supports the PictBridge standard, allowing you to connect to and print photos directly from any PictBridge compatible digital camera.

If your camera is using the USB Mass Storage standard, you can also print photos from a digital camera without PictBridge. (See *Printing photos directly from a digital camera (without PictBridge)* on page 67.)

PictBridge requirements

To avoid errors, remember the following points:

- The machine and the digital camera must be connected using a suitable USB cable.
- The image file extension must be .JPG (other image file extensions like .JPEG, .TIF, .GIF and so on will not be recognized).
- PhotoCapture Center™ operations are not available when using the PictBridge feature.

Setting your digital camera

Make sure your camera is in PictBridge mode. The following PictBridge settings may be available from the LCD of your PictBridge compatible camera.

Depending on your camera, some of these settings may not be available.

Camera Menu Selections	Options
Paper Size	A3, A4, Ledger, Letter, 10 × 15 cm, Printer Settings (Default setting) ²
Paper Type	Plain Paper, Glossy Paper, Inkjet Paper, Printer Settings (Default setting) ²
Layout	Borderless: On, Borderless: Off, Printer Settings (Default setting) ²
DPOF Setting ¹	-
Print Quality	Normal, Fine, Printer Settings (Default setting) ²
Colour Enhancement	On, Off, Printer Settings (Default setting) ²
Date Print	On, Off, Printer Settings (Default setting) ²

¹ See *DPOF printing* on page 67 for more details.

² If your camera is set to use the Printer Settings (Default setting), the machine will print your photo using the following settings.

Settings	Options
Paper Size	10 × 15 cm
Paper Type	Other Glossy
Layout	Borderless: On
Print Quality	Photo
Colour Enhancement	Off
Date Print	Off

- When your camera does not have any menu selections, these settings are also used.
- The name and availability of each setting depends on the specification of your camera.

Please refer to the documentation supplied with your camera for more detailed information on changing PictBridge settings.

Printing Images

NOTE

Remove any memory cards or USB Flash memory drives from the machine before connecting a digital camera.

- 1 Open the media slot cover.
- 2 Make sure that your camera is turned off. Connect your camera to the USB direct interface (1) on the machine using the USB cable.

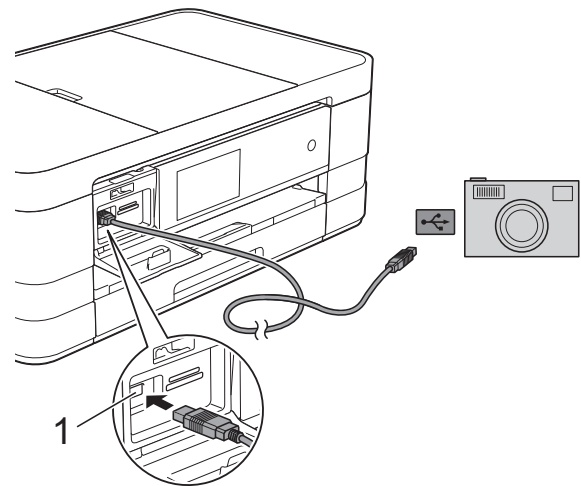

1 USB direct interface

- 3 Turn on the camera. When the machine has recognized the camera, the Touchscreen shows *Camera is connected.*
- 4 Choose the photo you want to print following the instructions from your camera. When the machine starts printing a photo, the Touchscreen will show *Printing.*

IMPORTANT

To prevent damage to your machine, do not connect any device other than a digital camera or USB Flash memory drive to the USB direct interface.

DPOF printing

DPOF stands for Digital Print Order Format.

Major digital camera manufacturers (Canon Inc., Eastman Kodak Company, FUJIFILM Corporation, Panasonic Corporation and Sony Corporation) created this standard to make it easier to print images from a digital camera.

If your digital camera supports DPOF printing, you will be able to choose the images and the number of copies you want to print on the display of the digital camera.

NOTE

A DPOF File error can occur if the print order that was created on the camera has been corrupted. Delete and recreate the print order using your camera to correct this problem. For instructions on how to delete or recreate the print order, refer to your camera manufacturer's support website or accompanying documentation.

Printing photos directly from a digital camera (without PictBridge)

If your camera supports the USB Mass Storage standard, you can connect your camera in storage mode. This enables you to print photos from your camera.

(If you would like to print photos in PictBridge mode, see *Printing photos directly from a PictBridge camera* on page 65.)

NOTE

The name, availability and operation differ among digital cameras. Please refer to the documentation supplied with your camera for detailed information, such as how to switch from PictBridge mode to USB mass storage mode.

Printing Images

NOTE

Remove any memory cards or USB Flash memory drives from the machine before connecting a digital camera.

- 1 Open the media slot cover.
- 2 Make sure that your camera is turned off. Connect your camera to the USB direct interface (1) on the machine using the USB cable.

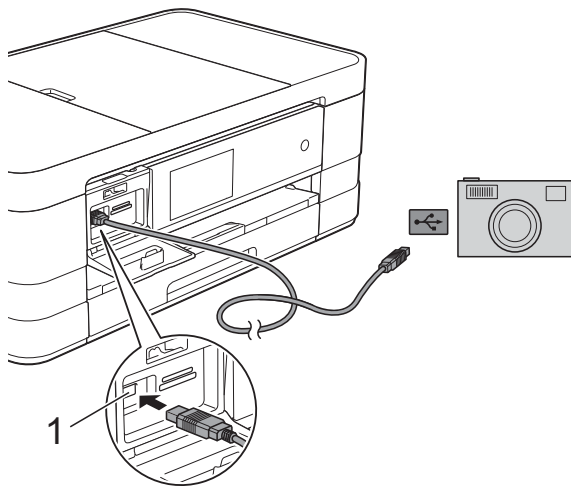

1 USB direct interface

- 3 Turn on the camera.
- 4 Follow the steps in *Print Images* on page 51.

IMPORTANT

To prevent damage to your machine, do not connect any device other than a digital camera or USB Flash memory drive to the USB direct interface.

A

Routine maintenance

Cleaning and checking the machine

Cleaning the outside of the machine

Clean the Touchscreen as follows:

IMPORTANT

- Press and hold down  to turn the machine off. The Touchscreen will show *Shutting Down* for a few seconds before the power goes off.
- DO NOT use any type of liquid cleaners (including ethanol).

- 1 Clean the Touchscreen with a *dry*, soft lint-free cloth.

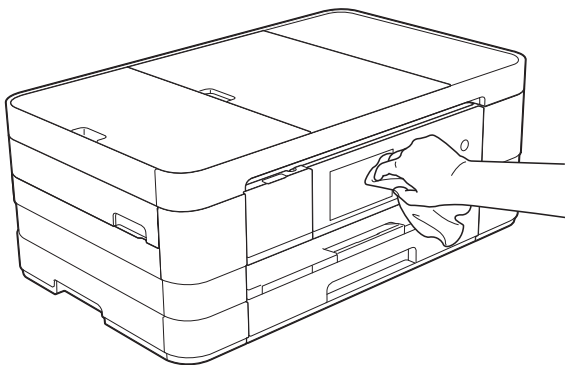

Clean the outside of the machine as follows:

IMPORTANT

- Use neutral detergents. Cleaning with volatile liquids such as thinner or benzine will damage the outside surface of the machine.
- DO NOT use cleaning materials that contain ammonia.
- DO NOT use isopropyl alcohol to remove dirt from the control panel. It may crack the panel.

- 1 Pull the paper tray (1) completely out of the machine.

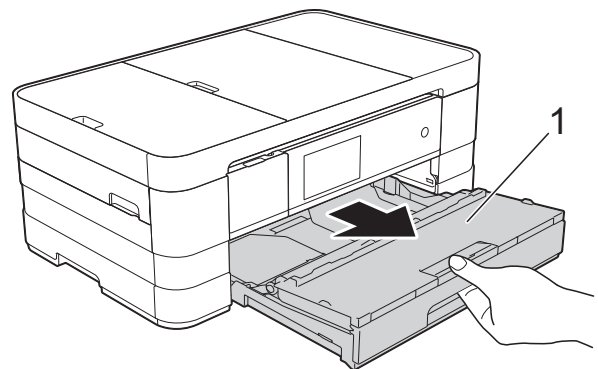

- 2 Wipe the outside of the machine with a *dry*, soft lint-free cloth to remove dust.

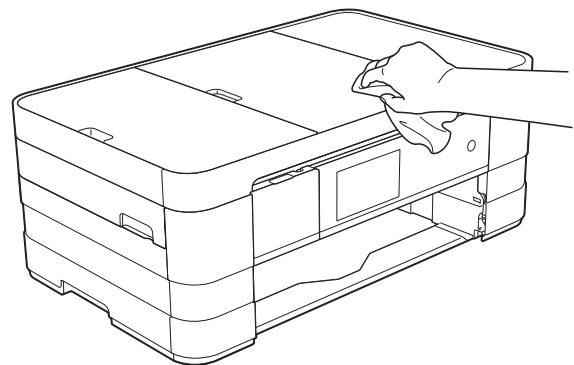

- 3 Lift the output paper tray cover and remove anything that is stuck inside the paper tray.
- 4 Wipe the inside and outside of the paper tray with a *dry*, soft lint-free cloth to remove dust.

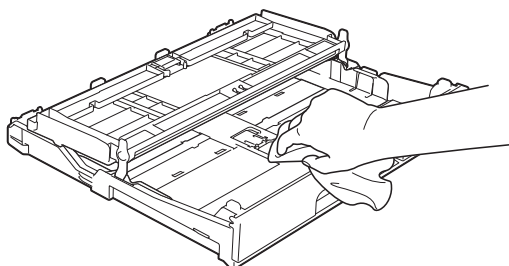

- 5 Close the output paper tray cover and put the paper tray firmly back in the machine.

Cleaning the machine's printer platen

WARNING



Be sure to unplug the machine from the electrical socket before cleaning the printer platen to avoid an electrical shock.

- 1 Using both hands, use the finger holds on each side of the machine to lift the scanner cover into the open position.
- 2 Clean the machine's printer platen (1) and the area around it, wiping off any scattered ink with a soft, *dry* lint-free cloth.

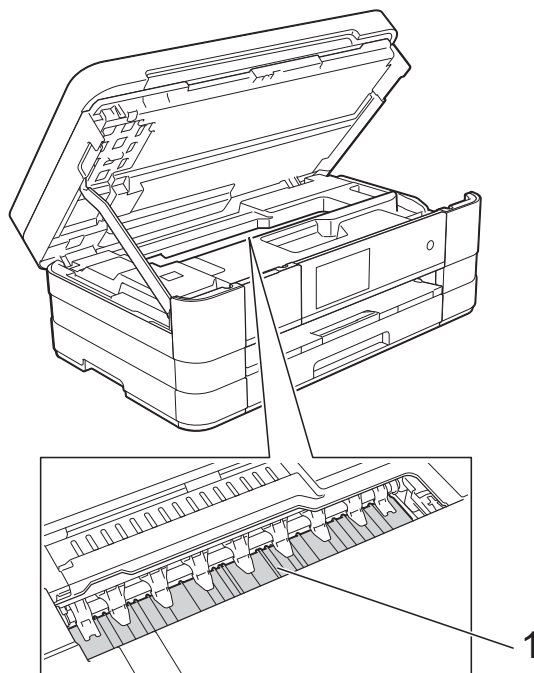

- 3 Lift the scanner cover to release the lock. Gently push the scanner cover support down and close the scanner cover using both hands.
- 4 Re-connect the power cord.

Cleaning the paper feed rollers

If the paper feed rollers are stained with ink, it may cause paper feed problems.

- 1 Unplug the machine from the electrical socket. Pull the paper tray (1) completely out of the machine.

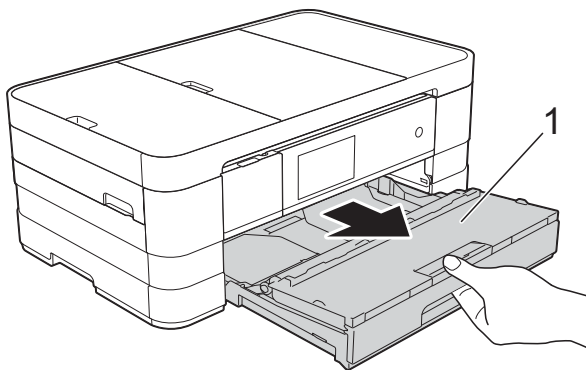

NOTE

If the paper support flap is open, close it, and then close the paper support.

- 2 Clean the front side of the Paper Feed Rollers (1) with a soft lint-free cloth slightly moistened with water, using a side-to-side motion. After cleaning, wipe the rollers with a *dry*, soft lint-free cloth to remove all moisture.

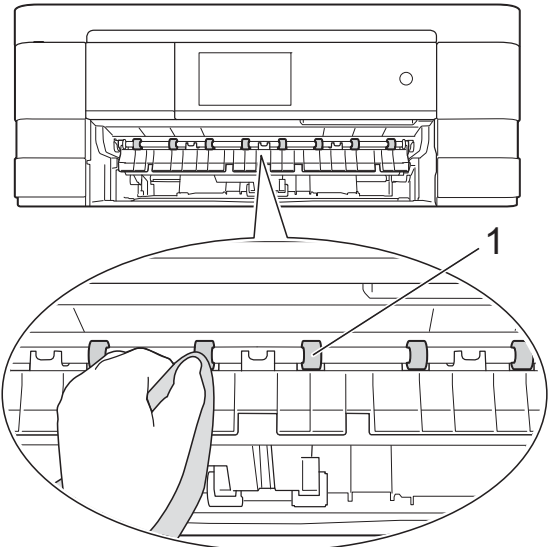

- 3 Lift the Jam Clear Flap (2), and then clean the back side of the Paper Feed Rollers (1) with a soft lint-free cloth slightly moistened with water. After cleaning, wipe the rollers with a *dry*, soft lint-free cloth to remove all moisture.

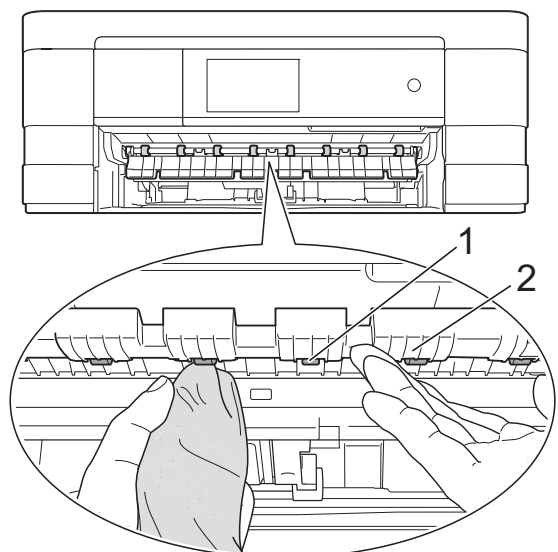

- 4 Put the paper tray firmly back in the machine.
- 5 Re-connect the power cord.

NOTE

Do not use the machine again until the rollers are completely dry. Using the machine before the rollers are dry may cause paper feed problems.

Cleaning the paper pick-up rollers

- 1 Unplug the machine from the electrical socket.
- 2 Pull the paper tray completely out of the machine.

NOTE

If the machine has been feeding multiple pages when there are only a few sheets of paper left in the tray, clean the Base Pad (1) with a soft lint-free cloth slightly moistened with water.

After cleaning, wipe the pad with a *dry*, soft lint-free cloth to remove all moisture.

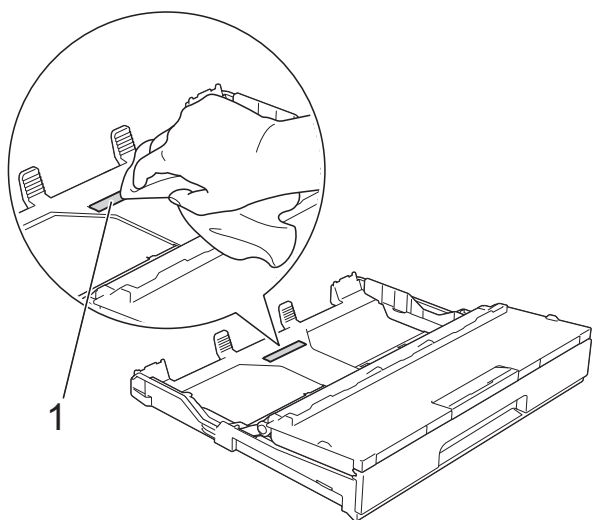

- 3 Clean the Paper Pick-up Rollers (1) with a soft lint-free cloth slightly moistened with water. Slowly turn the rollers so that the whole surface is cleaned. After cleaning, wipe the rollers with a *dry*, soft lint-free cloth to remove all moisture.

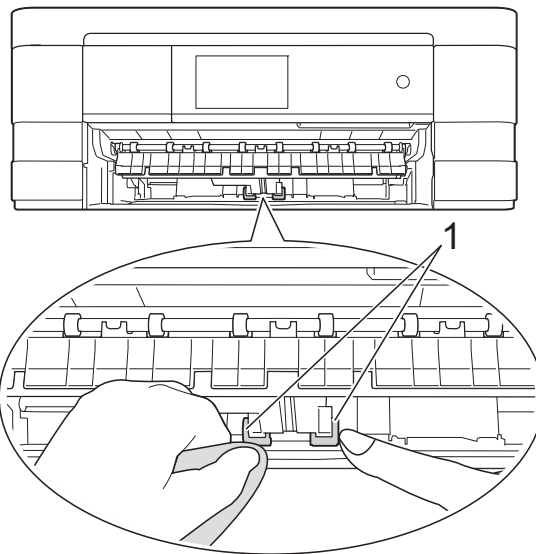

- 4 Put the paper tray firmly back in the machine.
- 5 Re-connect the power cord.

Checking the ink volume

Although an ink volume icon appears on the Touchscreen, you can use the ink menu to see a large graph showing the ink that is left in each cartridge.

- 1 Press .

NOTE

You can also press  and Ink.

- 2 Press Ink Volume.
The Touchscreen shows the ink volume.

- 3 Press .

NOTE

You can check the ink volume from your computer.

(See Software User's Guide: *Printing* (Windows®).)

(See Software User's Guide: *Printing and Faxing* (Macintosh).)

Packing and shipping the machine

When you transport the machine, use the packing materials that came with your machine. Follow the instructions below to correctly package your machine. Damage caused to your machine during transit may not be covered by your warranty.

The machine should be adequately insured with the carrier.

IMPORTANT

It is important to allow the machine to “park” the print head after a print job. Listen carefully to the machine before unplugging it to make sure that all mechanical noises have stopped. Not allowing the machine to finish this process may lead to print problems and possible damage to the print head.

- 1 Unplug the machine from the electrical socket.
- 2 Using both hands, use the finger holds on each side of the machine to lift the scanner cover into the open position. Then unplug the machine from the telephone wall socket and take the telephone line cord out of the machine.
- 3 Unplug the interface cable from the machine, if it is connected.

- 4 Lift the scanner cover (1) to release the lock. Gently push the scanner cover support down (2) and close the scanner cover (3) using both hands.

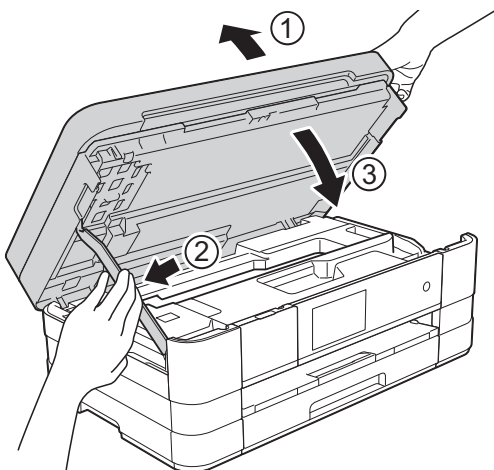

- 5 Open the ink cartridge cover.
- 6 Remove all four ink cartridges. Press the ink release lever above each cartridge to release it. (See Basic User's Guide: *Replacing the ink cartridges.*)
- 7 Install the orange protective part and then close the ink cartridge cover.

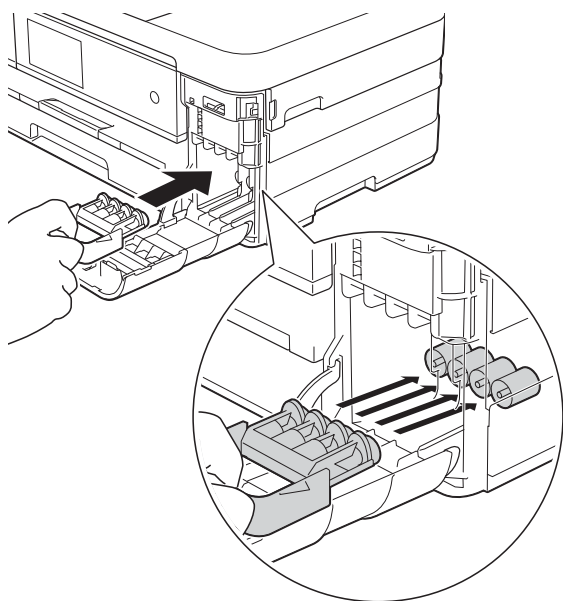

IMPORTANT

- Make sure the plastic tab on the left side of the orange protective part (1) clicks securely into place (2).

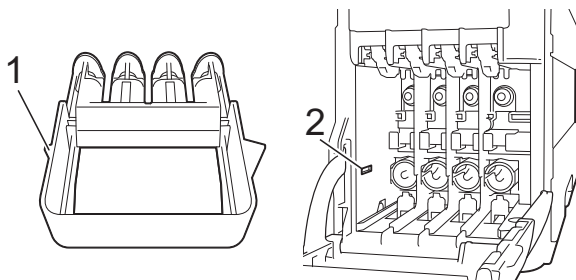

- If you are not able to find the orange protective part, ship the machine without it. DO NOT install the ink cartridges as an alternative before shipping.

- 8 Wrap the machine in the bag.

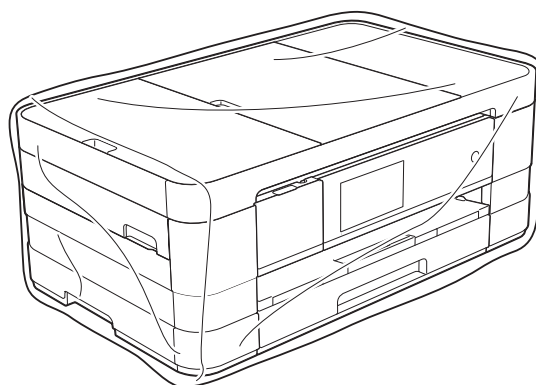

- 9 Pack the machine and the printed materials in the original carton with the original packing material as shown below.

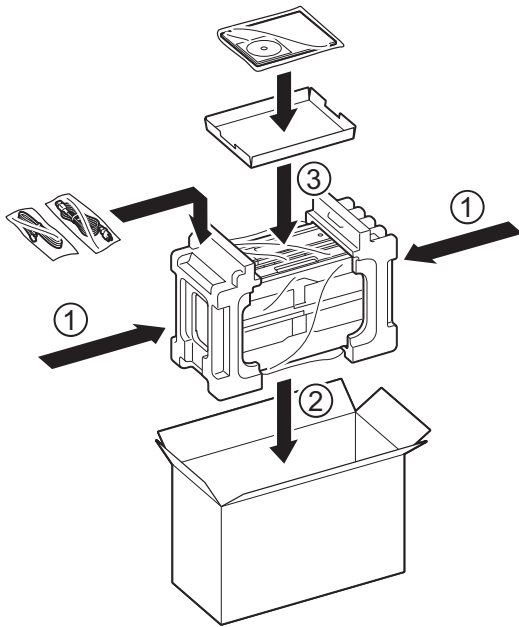

- 10 Close the carton and tape it shut.

B

Glossary

This is a comprehensive list of features and terms that appear in Brother manuals. Availability of these features depends on the model you purchased.

3.7" Touchscreen LCD and Touchpanel

The Touchscreen LCD (Liquid Crystal Display) on the machine shows interactive messages and prompts for using the machine. You can operate the Touchscreen by pressing or swiping on the screen.

The Touchpanel, on the right side of the Touchscreen LCD, illuminates its LEDs when they are available for the current operation.

Address Book

Names and numbers you have stored for easy dialling.

Address Book List

A listing of names and numbers stored in the Address Book memory, in alphabetical order.

ADF (automatic document feeder)

The document can be placed in the ADF and scanned one page at a time automatically.

Auto Reduction

Reduces the size of incoming faxes.

Automatic fax transmission

Sending a fax without picking up the handset of an external telephone.

Automatic Redial

A feature that enables your machine to redial the last fax number after five minutes if the fax did not go through because the line was busy.

Backup Print

Your machine prints a copy of every fax that is received and stored in its memory. This is a safety feature so you will not lose messages during a power failure.

Batch Transmission

(Monochrome faxes only) As a cost-saving feature, all delayed faxes to the same fax number can be sent as one transmission.

Beeper Volume

Volume setting for the beep when you press a key or make an error.

Brightness

Changing the Brightness makes the whole image lighter or darker.

Broadcasting

The ability to send the same fax message to more than one location.

Caller ID

A service purchased from the telephone company that lets you see the number (or name) of the party calling you.

CNG tones

The special tones (beeps) sent by fax machines during automatic transmission to tell the receiving machine that a fax machine is calling.

Coding method

Method of coding the information contained in the document. All fax machines must use a minimum standard of Modified Huffman (MH). Your machine is capable of greater compression methods, Modified Read (MR), Modified Modified Read (MMR) and JPEG, if the receiving machine has the same capability.

Colour Enhancement

Adjusts the colour in the image for better print quality by improving sharpness, white balance and colour density.

Communication error (Comm. Error)

An error during fax sending or receiving, usually caused by line noise or static.

Compatibility group

The ability of one fax unit to communicate with another. Compatibility is assured between ITU-T Groups.

Contrast

Setting to compensate for dark or light documents, by making faxes or copies of dark documents lighter and light documents darker.

Delayed Fax

Sends your fax at a specified time later.

Density

Changing the Density makes the whole image lighter or darker.

Distinctive Ring (Not available in New Zealand and Taiwan)

A subscriber service purchased from the telephone company that gives you another telephone number on an existing telephone line. The Brother machine uses the new number to simulate a dedicated fax line.

Dual Access

Your machine can scan outgoing faxes or scheduled jobs into the memory at the same time it is sending a fax from memory, receiving or printing an incoming fax.

ECM (Error Correction Mode)

Detects errors during fax transmission and resends the pages of the fax that had an error.

Extension telephone

A telephone using the same line as your fax but plugged into a separate wall socket.

External telephone

A TAD (telephone answering device) or telephone that is connected to your machine.

F/T Ring Time

The length of time that the Brother machine rings (when the Receive Mode setting is Fax/Tel) to notify you to pick up a voice call that it answered.

FaxAbility (New Zealand only)

A subscriber service purchased from the telephone company that provides another phone number on an existing phone line. The Brother fax machine uses the new number to simulate a dedicated fax line.

Fax Detect

Enables your machine to respond to CNG tones if you interrupt a fax call by answering it.

Fax Forwarding

Sends a fax received into the memory to another pre-programmed fax number.

Fax Journal

Lists information about the last 200 incoming and outgoing faxes. TX means Transmit. RX means Receive.

Fax Storage

You can store received faxes in memory.

Fax tones

The signals sent by sending and receiving fax machines while communicating information.

Fax/Tel

You can receive faxes and telephone calls. Do not use this mode if you are using a telephone answering device (TAD).

Fine resolution

Resolution is 203 × 196 dpi. It is used for small print and graphs.

Greyscale

The shades of grey available for copying, scanning and faxing photographs.

Group number

A combination of Address Book numbers that are stored in Address Book for Broadcasting.

Innobella™

Innobella™ is a range of genuine consumables offered by Brother. For best quality results, Brother recommends Innobella™ ink and paper.

Journal Period

The pre-programmed time period between automatically printed Fax Journal reports. You can print the Fax Journal report on demand without interrupting the cycle.

Manual fax

You can press **Hook** to hear the receiving fax machine answer before you press **Fax Start** to begin sending the fax.

Memory Receive

Receives faxes into the machine's memory when the machine is out of paper.

OCR (optical character recognition)

Nuance™ PaperPort™ 12SE or Presto! PageManager software application converts an image of text to text you can edit.

Overseas Mode

Makes temporary changes to the fax tones to accommodate noise and static on overseas telephone lines.

Pause

Allows you to place a 3.5 second delay in the dialling sequence while you are dialling using the dial pad or while you are storing Address Book numbers. Press **Pause** on the Touchscreen as many times as needed for longer pauses.

PhotoCapture Center™

Allows you to print digital photos from your digital camera at high resolution for photo quality printing.

Photo resolution (Mono only)

A resolution setting that uses varying shades of grey for the best representation of photographs.

PictBridge

Allows you to print photos directly from your digital camera at high resolution for photo quality printing.

Polling

The process of a fax machine calling another fax machine to retrieve waiting fax messages.

Pulse (Not available in New Zealand)

A form of rotary dialling on a telephone line.

Real Time Transmission

When the memory is full, you can send faxes in real time.

Remaining jobs

You can check which jobs are waiting in memory and cancel jobs individually.

Remote Access Code

Your own four-digit code (---*) that allows you to call and access your machine from a remote location.

Remote Activation Code

Press this code (* **5 1** (* **9 1** for New Zealand)) when you answer a fax call on an extension or external telephone.

Remote Deactivation Code (For Fax/Tel mode only)

When the machine answers a voice call, it fast double-rings. You can pick up at an extension telephone by pressing this code (**# 5 1** (**# 9 1** for New Zealand)).

Remote Retrieval Access

The ability to access your machine remotely from a touch-tone telephone.

Resolution

The number of vertical and horizontal lines per inch. See: Standard, Fine, Super Fine and Photo.

Ring Delay

The number of rings before the machine answers in **Fax Only** and **Fax/Tel** modes.

Ring Volume

Volume setting for the machine's ring.

Scanning

The process of sending an electronic image of a paper document to your computer.

Scan to Media

You can scan a monochrome or colour document on to a memory card or USB Flash memory drive. Monochrome images will be in the TIFF or PDF file format and colour images may be in the PDF or JPEG file format.

Search

An alphabetical electronic listing of stored Address Book and Group numbers.

Settings Tables

At-a-glance instructions that show all the settings and options that are available for setting up your machine.

Standard resolution

203 × 98 dpi (monochrome).
203 × 196 dpi (colour). It is used for regular sized text and the quickest transmission.

Station ID

The stored information that appears on the top of faxed pages. It includes the sender's name and fax number.

Super Fine resolution (Mono only)

203 × 392 dpi. Best for very small print and line art.

TAD (telephone answering device)

You can connect an external TAD to your machine.

Temporary settings

You can choose certain options for each fax transmission and copy without changing the default settings.

Tone (Not available in New Zealand)

A form of dialling on the telephone line used for touch-tone telephones.

Transmission

The process of sending faxes over the phone lines from your machine to the receiving fax machine.

Transmission Verification Report

A listing for each fax sent, that shows its date, time and number.

User Settings

A printed report that shows the current settings of the machine.

WLAN Report

A printed report that shows the result of the WLAN Connection.

C

Index

Numerics

2 in 1 ID Copy	41
2-sided	
copy	46

A

Access codes, storing and dialling	32
Address Book	
Broadcasting	14
deleting Groups	35
using Groups	14
Group dial	
changing	34
setting up Groups for Broadcasting ...	34
setting up from Caller ID history	33
setting up from outgoing calls	33
Apple Macintosh	
See Software User's Guide.	

B

Broadcasting	14
setting up Groups for	34

C

Caller ID	
Caller ID History report	37
Cancelling	
Fax Forwarding	22, 25
Fax Storage	22
jobs awaiting redial	17
Cleaning	
paper feed rollers	71
printer platen	70
ControlCenter	
See Software User's Guide.	

Copy

2 in 1 ID	41
2-sided	46
A3 shortcut	48
book	44
density	42
enlarge/reduce	39
ink save mode	43
page layout (N in 1)	40
poster	40
quality	38
remove background colour	45
sort (ADF only)	42
thin paper	43
using ADF	42
Watermark	44
using a template	44

D

Dialling

access codes and credit card	
numbers	32
dial prefix	3
Groups (Broadcasting)	14
restricting dialling	7

Direct printing

from a non-PictBridge camera	67
from a PictBridge camera	65

Dual Access	13
-------------------	----

F

Fax codes

changing	24
Remote Access Code	24

Fax Forwarding

changing remotely	25, 26
programming a number	20

Fax Storage	20
-------------------	----

printing from memory	21
turning off	22
turning on	20

Fax, from PC

 See Software User's Guide.

Fax, stand-alone	
receiving	
at end of conversation	27
Fax Forwarding	25
into PC	21
into the memory	27
out of paper reception	27
printing from memory	21
recovery printing	28
reducing to fit on paper	27
retrieving from a remote site	25, 26
sending	9
at end of conversation	13
Broadcasting	14
cancelling from memory	17
contrast	10
delayed batch transmission	17
delayed fax	16
from memory (Dual Access)	13
manual	13
overseas	16
Real Time Transmission	15
Resolution	10
return to factory default	12
set new default	11
Function Lock	4

G

Groups for Broadcasting	34
-------------------------------	----

I

ID Copy	41
Ink cartridges	
checking ink volume	73

L

LCD (Liquid Crystal Display)	
Dim Timer	2

M

Macintosh	
See Software User's Guide.	
Manual	
transmission	13
Memory Storage	1
Movie printing	51

N

Network	
Printing	
See Network User's Guide.	
Scanning	
See Software User's Guide.	
Nuance™ PaperPort™ 12SE	
See Software User's Guide. Also see Help in the PaperPort™ 12SE application.	

P

Packing and shipping the machine	73
PhotoCapture Center™	
Adding Effect	52
DPOF printing	55
from PC	
See Software User's Guide.	
Photo Effects	
Auto Correct	52, 53
Crop	52, 53, 54
Enhance Scenery	52, 53
Enhance Skin	52, 53
Fill Light	52, 53
Monochrome	52, 53
Night Scene	52, 53
Remove Red-Eye	52, 53
Sepia	52, 53
Whiteboard	52, 53
Print settings	
Borderless	60
Brightness	57
Colour enhancement	58
Contrast	58
Cropping	59
Date Print	60
Paper type & size	56
Quality	55
Return to factory default	61
rotate	54
Set new default	61
Printing	
index	51
photos	52
Scan to Media	
auto crop	62
memory card	62
USB Flash memory	62
Slide-Show	54

PictBridge	65
DPOF Printing	67
Power failure	1
Presto! PageManager	
See Software User's Guide. Also see Help in the Presto! PageManager application.	
Print	
fax from memory	21
report	37
Printing	
See Software User's Guide.	

R

Reducing	
copies	39
incoming faxes	27
Remote Retrieval	24
commands	25
getting your faxes	26
remote access code	24
Remote Setup	
See Software User's Guide.	
Reports	36
Address Book	37
Caller ID History Report	37
Fax Journal	37
Journal Period	36
how to print	37
Network Configuration	37
Transmission Verification	36, 37
User Settings	37
WLAN Report	37
Resolution	
setting for next fax	10
Restricted users	5

S

Scanning	
See Software User's Guide.	
Security	
Secure function lock	
administrator password	5
restricted users	5
Shipping the machine	73
Sleep Mode	2

T

Troubleshooting	
checking ink volume	73

W

Windows®	
See Software User's Guide.	
Wireless Network	
See Quick Setup Guide and Network User's Guide.	

brother®

Visit us on the World Wide Web
<http://www.brother.com/>

This machine is approved for use in the country of purchase only. Local Brother companies or their dealers will only support machines purchased in their own countries.



www.brotherearth.com

Free Manuals Download Website

<http://myh66.com>

<http://usermanuals.us>

<http://www.somanuals.com>

<http://www.4manuals.cc>

<http://www.manual-lib.com>

<http://www.404manual.com>

<http://www.luxmanual.com>

<http://aubethermostatmanual.com>

Golf course search by state

<http://golfingnear.com>

Email search by domain

<http://emailbydomain.com>

Auto manuals search

<http://auto.somanuals.com>

TV manuals search

<http://tv.somanuals.com>