

OWNER'S MANUAL

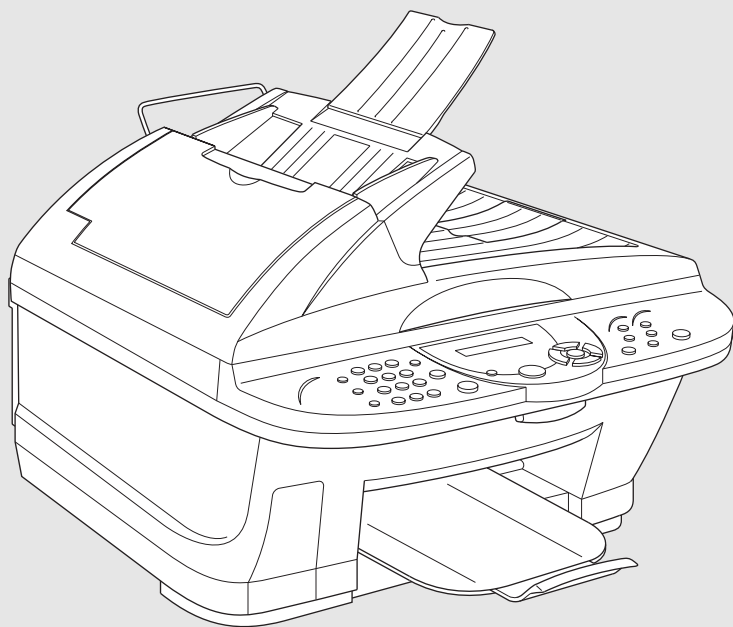

MFC-5100C

brother.

version C

If You Need to Call Customer Service

Please complete the following information for future reference:

Model Number: MFC-5100C

Serial Number:* _____

Date of Purchase: _____

Place of Purchase: _____

*** The serial number is on the back of the unit. Retain this Owner's Manual with your sales receipt as a permanent record of your purchase, in the event of a theft, fire or warranty service.**

Brother Numbers

IMPORTANT

For technical and operational assistance, you must call the country where you purchased the MFC. Calls must be made *from within* that country.

Brother fax-back system (USA Only)

Brother Customer Service has installed an easy-to-use fax-back system, so you can get instant answers to common technical questions and product information for all Brother products. This system is available 24 hours a day, 7 days a week. You can use the system to send faxes to any fax machine, not just the one from which you are calling.

If you can't resolve a difficulty with your MFC using this manual, call our fax-back system and follow the voice prompts to receive faxed instructions about using the system and an index of fax-back subjects.

In USA: 1-800-521-2846

The Brother fax-back system number has been preprogrammed on Speed Dial # 01.

Frequently Asked Questions (FAQs)

The Brother Solutions Center is our one-stop resource for all your Fax Machine/Multi-Function Center needs. You can download the latest software and utilities, read FAQs and troubleshooting tips, and go to the "Solutions" section to learn how to get the most from your Brother product.

<http://solutions.brother.com>



You can check here for Brother driver updates.

For Customer Service

In USA: 1-800-284-4329 (voice)
1-908-575-8790 (fax)
1-800-284-3238 (TTY service for the hearing-impaired)

In Canada: 1-877-BROTHER (voice)
1-514-685-4898 (fax)
1-514-685-6464 (voice) **In Montreal**

Dealers/Service Centers (For USA Only)

For the name of a Brother authorized dealer or service center, call 1-800-284-4357.

Service Centers (For Canada Only)

For service center addresses in Canada, call 1-877-BROTHER.

Ordering Accessories and Supplies

IMPORTANT

For technical and operational assistance, you must call the country where you purchased the MFC. Calls must be made *from within* that country.

For best quality results use only genuine Brother accessories, available at most Brother retailers. If you cannot find the accessory you need and you have a Visa, MasterCard, Discover, or American Express credit card, you can order accessories directly from Brother. (In the USA, you can visit us online for a complete selection of Brother accessories and supplies available for purchase.)

In USA: 1-888-879-3232 (voice)
1-800-947-1445 (fax)
<http://www.brothermall.com>

In Canada: 1-877-BROTHER (voice)

Description	Item
Ink Cartridge <black>	LC21BK
Ink Cartridge <cyan>(blue)	LC21C
Ink Cartridge <magenta>(red)	LC21M
Ink Cartridge <yellow>	LC21Y
Power Protector	QPD120
Telephone Line Cord	LG3077001
Paper Wire Extension	LE6522001
Paper Tray	LE6398001
Card Stock Support	LE6519001
Owner's Manual	LE6310001 (English for USA and Canada) LE6437001 (French For Canada)

 *Multi-Function Link® Pro Suite is NOT available on floppy disks.*

Notice – Disclaimer of Warranties (For USA and Canada)

BROTHER'S LICENSOR(S), AND THEIR DIRECTORS, OFFICERS, EMPLOYEES OR AGENTS (COLLECTIVELY BROTHER'S LICENSOR) MAKE NO WARRANTIES, EXPRESS OR IMPLIED, INCLUDING WITHOUT LIMITATION THE IMPLIED WARRANTIES OF MERCHANTABILITY AND FITNESS FOR A PARTICULAR PURPOSE, REGARDING THE SOFTWARE. BROTHER'S LICENSOR(S) DOES NOT WARRANT, GUARANTEE OR MAKE ANY REPRESENTATIONS REGARDING THE USE OR THE RESULTS OF THE USE OF THE SOFTWARE IN TERMS OF ITS CORRECTNESS, ACCURACY, RELIABILITY, CURRENTNESS OR OTHERWISE. THE ENTIRE RISK AS TO THE RESULTS AND PERFORMANCE OF THE SOFTWARE IS ASSUMED BY YOU. THE EXCLUSION OF IMPLIED WARRANTIES IS NOT PERMITTED BY SOME STATES IN THE USA AND SOME PROVINCES IN CANADA. THE ABOVE EXCLUSION MAY NOT APPLY TO YOU.

IN NO EVENT WILL BROTHER'S LICENSOR(S) BE LIABLE TO YOU FOR ANY CONSEQUENTIAL, INCIDENTAL OR INDIRECT DAMAGES (INCLUDING DAMAGES FOR LOSS OF BUSINESS PROFITS, BUSINESS INTERRUPTION, LOSS OF BUSINESS INFORMATION, AND THE LIKE) ARISING OUT OF THE USE OR INABILITY TO USE THE SOFTWARE EVEN IF BROTHER'S LICENSOR HAS BEEN ADVISED OF THE POSSIBILITY OF SUCH DAMAGES. BECAUSE SOME STATES IN THE USA AND SOME PROVINCES IN CANADA DO NOT ALLOW THE EXCLUSION OR LIMITATION OF LIABILITY FOR CONSEQUENTIAL OR INCIDENTAL DAMAGES, THE ABOVE LIMITATIONS MAY NOT APPLY TO YOU. IN ANY EVENT BROTHER'S LICENSOR'S LIABILITY TO YOU FOR ACTUAL DAMAGES FROM ANY CAUSE WHATSOEVER, AND REGARDLESS OF THE FORM OF THE ACTION (WHETHER IN CONTRACT, TORT (INCLUDING NEGLIGENCE), PRODUCT LIABILITY OR OTHERWISE), WILL BE LIMITED TO \$50.

Compilation and Publication Notice

Under the supervision of Brother Industries Ltd., this manual has been compiled and published, covering the latest product descriptions and specifications.

The contents of this manual and the specifications of this product are subject to change without notice.

Brother reserves the right to make changes without notice in the specifications and materials contained herein and shall not be responsible for any damages (including consequential) caused by reliance on the materials presented, including but not limited to typographical and other errors relating to the publication.

BROTHER ONE YEAR LIMITED WARRANTY and EXCHANGE SERVICE (USA Only)

This warranty gives you certain rights and you may also have other rights that may vary from state to state.

This warranty is given only to the first end-user purchaser of the accompanying product (referred to in this warranty as "this Product").

What is covered: Brother warrants to you for the Warranty Period that there are no defects in the materials, workmanship or Year 2000 compliance of this Product. The "Warranty Period" is 1 year from the date you purchased this product. The "Warranty Period" for consumable items, such as Print Heads, Toner, Drums, Ink Cartridges, Print Cartridges, Refill Ribbons, Therma PLUS Paper and Thermal Paper, etc. is 90 days from the date of purchase, or the rated life of the Consumable item, whichever is shorter.

What is NOT covered: Warranty WILL BE VOID by Brother for repairs or replacements made necessary due to the following: (1) If the Product was not purchased from an authorized Brother reseller within the United States, (2) The Product has been serviced or modified by anyone other than an Authorized Service Representative of Brother, (3) The serial number has been modified, defaced or removed from this Product, (4) Non-Brother®-brand or non-Brother approved parts, supplies, power supplies or other accessories have been used with this Product, (5) Any damage caused by accident, neglect, abuse or misuse or, the recommended monthly volume has been exceeded, (6) Damages caused as a result of modification, alteration or repairs performed by anyone other than a Brother Authorized Service Representative. (7) NOT COVERED UNDER WARRANTY ARE: Consumable items, for example (including, but not limited to): ribbons, ink or toner cartridges, toner drum units, print heads, cleaning and/or instances where no defects in material or workmanship are found in the Product, etc. (8) Damage caused by improper connection and/or disconnection of the Product; failure of the operator to follow operational instructions, improper set up of the Product.

What to do if you think your Product is defective:

Call our Customer Service Hotline at [1-800-284-4329](tel:1-800-284-4329), or if you suspect a defect in materials or workmanship in this Product, you can report it to a Brother Authorized Service Center. During the Warranty Period,

supply Brother's representative with a copy of your dated bill of sale showing that this Product was purchased within the United States. For the name of your Brother Authorized Service Center, call 1-800-521-2846. After contacting the Brother Authorized Service Center, you may be required to deliver or send the Product properly packaged, freight prepaid, to the Authorized Service Center together with a photocopy of your bill of sale.

What Brother will do: Brother (or its Authorized Service Center) will evaluate your report of a possible defect to determine whether a defect exists, and if it does exist, Brother (or its Authorized Service Center) will repair or (at Brother's option) replace the Product with a product that performs the same functions and performs as well as the original Product. Brother reserves the right to supply refurbished or remanufactured replacement parts provided that the replacement parts conform to the manufacturer's specifications for new products. The repaired or replacement product will be returned to you at no cost.

Exchange Service:

When an exchange is authorized, Brother will exchange your non-working product with a refurbished or remanufactured product that conforms to the manufacturer's specifications for new products. The refurbished or remanufactured Product you receive will be covered by the balance of the limited warranty period remaining on the original Product, plus an additional thirty (30) days. You will keep the replacement Product that is sent to you and must return (or be billed up to the cost of a new product) your original non-working product, which shall become the property of Brother. You must call Brother Customer Service and if the representative cannot correct the product's malfunction over the telephone and you elect the exchange service, you must provide information pertaining to this Product and you must also provide a valid major credit card number. Your credit card will be charged up to the cost of a new Product if: (i) you do not return your original Product to Brother within five (5) business days; (ii) the malfunctions of your original Product are not covered by the limited warranty; (iii) the proper packaging instructions are not followed and has caused damage to the product;

BROTHER ONE YEAR LIMITED WARRANTY and EXCHANGE SERVICE (For USA Only)

or (iv) the warranty period on your original Product has expired or has not been sufficiently validated with a copy of the proof of purchase (bill of sale). The Brother Customer Service Representative will ship the exchange Product via next business day delivery courier service, with return instructions and prepaid return air bill. Follow the return instructions. You must return the original Product in the same shipping carton in which the exchanged Product was received and include a copy of proof of purchase (bill of sale). Retain your original accessory items and a copy of the return air bill, signed by the courier.

Limitations:

Repair or replacement as described above is your sole and exclusive (that is, your only) remedy if this Product is defective. Brother is not responsible for damage to or loss of any equipment, media, programs or data related to the use of this Product. Except for that repair or replacement, *Brother shall not be liable for any direct, indirect, incidental or consequential damages or specific relief. Because some states do not allow the exclusion or limitation of consequential or incidental damages, the above limitation may not apply to you.*

THIS WARRANTY IS GIVEN IN LIEU OF ALL OTHER WARRANTIES, WRITTEN OR ORAL, WHETHER EXPRESSED BY AFFIRMATION, PROMISE, DESCRIPTION, DRAWING, MODEL OR SAMPLE. ANY AND ALL WARRANTIES OTHER THAN THIS ONE, WHETHER EXPRESS OR IMPLIED, INCLUDING IMPLIED WARRANTIES OF MERCHANTABILITY AND FITNESS FOR A PARTICULAR PURPOSE, ARE HEREBY DISCLAIMED.

This Limited Warranty is the only warranty that Brother is giving for this Product. It is the *final expression and the exclusive and only statement* of Brother's obligations to you. It replaces all other agreements and understandings that you may have with Brother or its representatives.

This Limited Warranty (and Brother's obligation to you) may not be changed in any way unless you and Brother sign the same piece of paper in which we (1) refer to this Product and your bill of sale date, (2) describe the change to this warranty and (3) agree to make that change.

Product Support:

Toll-free Customer Service and technical support is available for hardware operational assistance at 1-800-284-4329. At any time, free technical support in the form of Frequently Asked Questions, troubleshooting tips and service center locator is available through our fax-back system at 1-800-521-2846 or Brother's Internet Web Site (www.brother.com). Now you can visit us on-line (www.brothermall.com), your complete source for genuine Brother Accessories and Supplies.

**BROTHER INTERNATIONAL CORPORATION
100 SOMERSET CORPORATE BLVD.
BRIDGEWATER, NEW JERSEY 08807-0911**

Please record your model and serial numbers and your date and location of Purchase below for your records. Keep this information with your proof of purchase (bill of sale) in case your Product is lost, stolen or requires service.

Model # _____

Serial # _____

Date of purchase: _____

Store where purchased: _____

Location of store: _____

Important: We recommend that you keep all original packing materials, in the event that you ship this product.

**BROTHER MULTIFUNCTION CENTER/FACSIMILE MACHINE
LIMITED WARRANTY
(For Canada Only)**

Pursuant to this limited warranty of 1 year from the date of purchase for labour and parts, Brother International Corporation (Canada) Ltd. ("Brother"), or its Authorized Service Centers, will repair this MFC/Facsimile machine free of charge if defective in material or workmanship. This Limited Warranty does not include cleaning, consumables (including, without limitation, print cartridges, print head, toner and drum) or damage caused by accident, neglect, misuse or improper installation or operation, any damage caused from service, maintenance, modifications, or tampering by anyone other than a Brother Authorized Service Representative, or from the use of supplies or consumable items that are non-Brother products. Operation of the MFC/Facsimile machine in excess of the specifications or with the Serial Number or Rating Label removed shall be deemed abuse and all repairs thereafter shall be the sole liability of the end-user/purchaser. In order to obtain warranty service, the MFC/Facsimile machine must be delivered or shipped freight prepaid by the end user/purchaser to a "Brother" Authorized Service Center, together with your Proof of Purchase in the form of a Sales Receipt.

For laser products: Failure to remove the Toner Cartridge (and Toner Drum Unit on applicable models) during shipping will cause severe damage to the MFC/Facsimile and will VOID the Warranty. (Refer to your Operation Manual for proper packaging.)

For ink-jet products: Do not remove the ink cartridges during shipping. Damage to your print head resulting from packing without the ink cartridges will VOID your warranty. (Refer to your Operation Manual for proper packaging.)

BROTHER DISCLAIMS ALL OTHER WARRANTIES EXPRESSED OR IMPLIED INCLUDING, WITHOUT LIMITATION, ANY IMPLIED WARRANTIES OF MERCHANTABILITY OR FITNESS FOR A PARTICULAR PURPOSE, EXCEPT TO THE EXTENT THAT ANY WARRANTIES IMPLIED BY LAW CANNOT BE VALIDLY WAIVED.

No oral or written information, advice or representation provided by Brother, its Authorized Service Centers, Distributors, Dealers, Agents or employees, shall create another warranty or modify this warranty. This warranty states Brother's entire liability and your exclusive remedy against Brother for any failure of the MFC/Facsimile machine to operate properly.

Neither Brother nor anyone else involved in the development, production, or delivery of this MFC/Facsimile machine shall be liable for any indirect, incidental, special, consequential, exemplary, or punitive damages, including lost profits, arising from the use of or inability to use the product, even if advised by the end user/purchaser of the possibility of such damages. Since some Provinces do not allow the above limitation of liability, such limitation may not apply to you.

This Limited Warranty gives you specific legal rights and you may also have other rights which vary from Providence to Providence.

Warranty Service is available at Brother Authorized Service Centers throughout Canada. For Technical Support or for the name and location of your nearest Authorized Service Center call 1-877-BROTHER. Within Montreal, please call 685-6464. Internet support: support@brother.ca or browse Brother's Web Site: www.brother.com

Brother International Corporation (Canada) Ltd.
1 Rue Hôtel de Ville
Dollard-Des-Ormeaux, QC H9B 3H6

At your side.
brother®



Quick Reference Guide



Sending Black & White Faxes

Automatic Transmission

- 1 Place the original face up in the ADF, or face down on the scanner glass.
- 2 Enter the fax number using Speed Dial, Search or the dial pad.
- 3 Press **Black Fax Start**.

Real Time Transmission

You can send faxes in real time.

- 1 Place the original face up in the ADF, or face down on the scanner glass.
- 2 Press **Menu/Set, 2, 2, 5**.
- 3 Press  to select **ON** (or **OFF**) and press **Menu/Set—OR—For** the next transmission only, press  to select **NEXT FAX ONLY**, and then press **Menu/Set**.
- 4 For the next fax only, press  to select **ON**, and then press **Menu/Set**.
- 5 Press **1** to select additional settings—**OR**—Press **2** to fax.
- 6 Enter the fax number.
- 7 Press **Black Fax Start**.

Receiving Faxes

Select Receive Mode

Press **Receive Mode** to select **FAX ONLY**, **EXT.TEL/TAD** or **MANUAL**.

Storing Numbers

Storing Speed Dial Numbers



- 1 Press **Menu/Set, 2, 3, 1**.
- 2 Enter a two-digit Speed Dial number and press **Menu/Set**.
- 3 Enter a number (up to 20 digits) and press **Menu/Set**.
- 4 Enter a name (or leave it blank) and press **Menu/Set**.
- 5 Press **Stop/Exit**.

Dialing Operations

Speed Dialing

- 1 Place the original face up in the ADF, or face down on the scanner glass.
- 2 Press **Search/Speed Dial**, press **#**, then press the two-digit Speed Dial number.
- 3 Press **Black Fax Start**.

Search/Speed Dial



- 1 Place the original face up in the ADF, or face down on the scanner glass.
- 2 Press **Search/Speed Dial**, and then enter the first letter of the name you're looking for.
- 3 Press  or  to search the memory.
- 4 Press **Black Fax Start**, when the LCD shows the name you want to call.

Making Copies

Making a Single Copy

- 1 Place the original face up in the ADF, or face down on the scanner glass.
- 2 Press **Black Copy** or **Color Copy**.

Sorting Multiple Copies (Using the ADF)

- 1 Place the original face up in the ADF.
- 2 Use the dial pad to enter the number of copies you want (up to 99).
- 3 Press **Options**.
- 4 Press  to select **OPT:STACK/SORT**, and then press **Menu/Set**.
- 5 Press  to select **SORT**, and then press **Menu/Set**.
Press **Black Copy** or **Color Copy**.

Brother fax-back system :

In USA: 1-800-521-2846

Brother Global Web Site :

<http://www.brother.com>

Frequently Asked Questions (FAQs) and Product Support
<http://solutions.brother.com>

Brother Accessories & Supplies:

In USA: 1-888-879-3232 (voice)

1-800-947-1445 (fax)

<http://www.brothermall.com>

In Canada: 1-877-BROTHER (voice)

Table of Contents

1

Introduction.....	1-1
Using This Manual	1-1
Finding Information.....	1-1
Conventions Used in this Manual.....	1-1
Test Sheet Procedure and Product Registration (For USA Only) ..	1-2
To Complete Your MFC-5100C Registration On-Line	1-2
MFC-5100C Control Panel Overview.....	1-3
About Fax Machines	1-5
Custom Features	1-5
Do You Have Voice Mail on the Phone Line?	1-5
Why Should There Be Trouble?	1-5
How Can You Avoid Possible Problems?	1-5
Fax Tones and Handshake.....	1-5
ECM (Error Correction Mode).....	1-6

2

Assembly and Connections.....	2-1
Packing List.....	2-1
Choosing a Location.....	2-2
Important Safety Instructions.....	2-3
Paper.....	2-3
Handling and Using Special Paper	2-3
Recommended Paper for the MFC-5100C	2-3
Paper Capacity of Multi-Purpose Sheet Feeder.....	2-4
Paper Specifications for Multi-Purpose Sheet Feeder.....	2-4
Print Area.....	2-5
Assembly.....	2-6
Removing the Protective Yellow Bar.....	2-6
Setting up the MFC	2-7
Loading Paper in the Multi-Purpose Sheet Feeder (Paper Cassette)	2-9
Installing the Ink Cartridges.....	2-10
Important.....	2-11
Connecting the MFC	2-13
Connecting an External Telephone	2-13
Connecting an External Telephone Answering Device (TAD)	2-13
Sequence	2-13
Connections.....	2-14

Recording Outgoing Message (OGM).....	2-14
Special Line Considerations	2-15
Roll Over Phone Lines	2-15
Two-Line Phone System	2-15
Converting Telephone Wall Outlets	2-16
Installing MFC, External Two-Line TAD and Two-Line Telephone	2-16
Multi-Line Connections (PBX)	2-17
If You are Installing the MFC to Work with a PBX.....	2-17
Custom Features on Your Phone Line.....	2-18

3

On-Screen Programming..... 3-1

User-Friendly Programming.....	3-1
Menu Selection Table.....	3-1
Alternating Displays	3-1
Navigation Keys	3-2

4

Initial Setup..... 4-1

Getting Started.....	4-1
Setting Paper Type	4-1
Setting Paper Size	4-1
Setting Date and Time	4-2
Setting Station ID	4-2
Entering Text.....	4-3
Inserting Spaces	4-3
Making Corrections.....	4-3
Repeating Letters	4-3
Special Characters and Symbols	4-3
Setting the Ring Volume	4-4
Setting the Beeper Volume.....	4-5
Turning On Automatic Daylight Savings Time	4-5
Setting Tone/Pulse Dialing Mode (For Canada Only)	4-5
Memory Storage	4-5

5

Setup Receive..... 5-1

Basic Receiving Operations	5-1
Choosing the Receive Mode.....	5-1
To Select or Change Your Receive Mode	5-2
Setting Ring Delay	5-2
Easy Receive	5-3
Printing a Reduced Incoming Fax (Auto Reduction)	5-3

Advanced Receiving Operations	5-4
Operation from Extension Telephone	5-4
Changing the Fax Receive Code.....	5-4
Printing a Fax in Memory.....	5-4
Polling.....	5-5
Setting Up Polling Receive	5-5
Setting Up Sequential Polling Receive	5-5
Canceling a Scheduled Job	5-6
Telephone Services	5-7
Distinctive Ring.....	5-7
What Does Your Telephone Company’s	
“Distinctive Ring” Do?	5-7
What Does Brother’s “Distinctive Ring” Do?	5-7
Do You Have Voice Mail?	5-8
Before You Choose the Ring Pattern to Register	5-8
Very Important	5-9
Registering the Distinctive Ring Pattern.....	5-9

6

Setup Send	6-1
Before You Begin.....	6-1
Sending Faxes Using Multiple Settings	6-1
Faxing from the ADF (Automatic Document Feeder)	6-1
Recommended Environment.....	6-1
Setting the Special Media Lever.....	6-2
Faxing from the Scanner Glass.....	6-3
Basic Sending Operations	6-4
Contrast.....	6-4
Fax Resolution.....	6-4
Manual Transmission (With an External Telephone)	6-5
Automatic Transmission.....	6-5
Color Fax Transmission	6-5
Manual and Automatic Fax Redial.....	6-5
Dual Access (Not Available for Color Fax).....	6-5
Real Time Transmission.....	6-6
Checking Job Status	6-7
Canceling a Job in Memory.....	6-7
Advanced Sending Operations	6-7
Overseas Mode	6-7
Delayed FAX (Not Available for Color Fax).....	6-8
Delayed Batch Transmission (Not Available for Color Fax)...	6-8

Setting Up Polled Transmit (Not Available for Color Fax).....	6-9
--	-----

7

Auto Dial Numbers and Dialing Options	7-1
Storing Numbers for Easy Dialing	7-1
Storing Speed Dial Numbers	7-1
Changing Speed Dial Numbers	7-2
Setting Up Groups for Broadcasting	7-3
Dialing Options	7-4
Search	7-4
Speed Dialing	7-4
Access Codes and Credit Card Numbers.....	7-4
Broadcasting (Not Available for Color Fax)	7-5
Pause	7-6
Fax Redial.....	7-6
Tone/Pulse (For Canada Only).....	7-6

8

Remote Fax Options (Not Available for Color Fax)	8-1
Fax Forwarding/Paging	8-1
Programming a Fax Forwarding Number.....	8-1
Programming Your Pager Number.....	8-1
Setting Fax Storage	8-2
Backup Print	8-2
Changing Remote Retrieval Access Code.....	8-3
Remote Retrieval.....	8-3
Using Remote Retrieval Access Code.....	8-3
Remote Commands	8-4
Retrieving Fax Messages.....	8-5
Changing Fax Forwarding Number.....	8-5

9

Printing Reports	9-1
MFC Settings and Activity.....	9-1
Customizing the Transmission Verification Report	9-1
Setting the Fax Activity Report Interval	9-1
Using the Reports Key.....	9-2
To Print a Report.....	9-2

10

Making Copies	10-1
Basic Copy Operations.....	10-1
Making a Single Copy	10-1

Making Multiple Copies (Using the ADF).....	10-1
Out of Memory Message	10-2
Single or Multiple Copies (Using the Scanner Glass).....	10-2
Temporary Copy Settings.....	10-3
Copying Using Multiple Settings	10-3
Using the Enlarge/Reduce Key	10-3
Selecting a Fixed Reduction Ratio.....	10-4
Using the Quality Key	10-4
Using the Options Key	10-5
Paper Type	10-6
Paper Size.....	10-6
Copy Brightness.....	10-6
Sorting Multiple Copies (Using the ADF)	10-7
Special Copy Options (Using the ADF).....	10-7
Special Copy Options (Using the Scanner Glass)	10-7
2 in 1	10-8
4 in 1	10-8
Poster.....	10-8
Changing Default Copy Settings.....	10-9
Copy Quality	10-9
Color Adjustment	10-10
Copy Contrast.....	10-10
Legal Limitations	10-11

11

Using the MFC as a Printer	11-1
Features	11-1
Printer Driver.....	11-1
Choosing the Right Kind of Paper	11-2
Multi-purpose Sheet Feeder	11-2
Simultaneous Printing and Faxing	11-3
Printer Operation Key	11-3
Ink Key	11-3
Stop/Exit Key	11-3
Checking the Print Quality.....	11-3

12

Printer Driver Settings (For Windows® Only).....	12-1
Using the Brother MFC-5100C Printer Driver	12-1
Features in the Printer Driver (For Windows® 95/98/98SE/Me/ 2000 Professional and Windows NT® 4.0).....	12-1
Paper Tab.....	12-2
Paper Size	12-2

Orientation.....	12-3
Copy/Page Order	12-3
Copies	12-3
Collate	12-3
Reverse Order	12-3
Paper Thickness.....	12-4
Scaling	12-4
Paper Source.....	12-4
Quality/Color Tab.....	12-5
Quality	12-5
Media.....	12-6
Document	12-6
Color Matching.....	12-7
Custom Setting	12-7
Halftone Pattern	12-7
Color Enhance.....	12-8
Color/Mono	12-9
Bi-Directional Printing	12-9
Fast Draft Mode.....	12-9
Advanced Tab.....	12-9
Watermark	12-10
Print Watermark.....	12-10
In background	12-10
Watermark Style.....	12-10
Watermark Text	12-10
Watermark Bitmap.....	12-10
Position	12-11
Device Options	12-11
Print Date & Time	12-11
Support	12-12
Web Update.....	12-12
Brother Solutions Center.....	12-12
Features in the Printer Driver (For Windows® XP)	12-13
Layout Tab	12-13
*1 Orientation.....	12-13
*2 Pages Per Sheet.....	12-14
Paper/Quality Tab.....	12-14
*1 Tray Selection.....	12-15
*2 Quality Settings	12-15
*3 Color.....	12-15
Advanced Options	12-16

*1 Paper /Output.....	12-16
*2 Graphic	12-17
*3 Document Options.....	12-17
Photo	12-17
Cluster	12-17
Auto.....	12-17
*4 Printer Features.....	12-18

Using the Windows®-Based Brother MFL-Pro Control Center ... 13-1

Brother MFL-Pro Control Center.....	13-1
AutoLoad the Brother Control Center.....	13-1
How to Turn Off AutoLoad.....	13-2
Using the Color Scan Key	13-2
Scan to E-mail	13-3
Scan Image	13-3
Scan/OCR.....	13-3
Brother Control Center Features	13-4
Auto Configuration.....	13-4
Scanning Operations.....	13-4
Copy Operations.....	13-5
PC Fax Operation	13-5
Scanner Settings for Scan, Copy and PC Fax Buttons	13-5
Global Settings	13-5
Setting Up the Scanner Configurations	13-6
To Access the Scanner Configurations Screen.....	13-6
Perform an Operation from the Control Center Screen.....	13-6
Scan to File.....	13-7
Scanner Settings	13-7
Destination Folder	13-8
Scan to E-mail	13-8
Scanner Settings	13-9
E-mail Application	13-9
File Attachments.....	13-9
Conversion Options	13-10
Format.....	13-10
Show QuickSend Menu	13-10
QuickSend List.....	13-10
Scan to Word Processor	13-11
Scanner Settings	13-11
Word Processor	13-12
User Defined Button.....	13-13

Scanner Settings	13-13
Target Application.....	13-13
Copy	13-13
Scanner Settings	13-14
Copy Settings.....	13-14
Send a Fax	13-14
Scanner Settings	13-14
FAX Settings	13-15

14

Scanner and Using ScanSoft™ PaperPort® and TextBridge®

OCR (For Windows® Only)	14-1
Using ScanSoft™ PaperPort® and TextBridge®	14-1
Viewing Items	14-2
Organizing Your Items in Folders.....	14-2
Links to Many Other Applications	14-3
Using ScanSoft™ TextBridge® OCR (Converting Image Text to Text You Can Edit)	14-3
Importing Items from Other Applications	14-4
Exporting Items in Other Formats	14-4
Exporting an Image File.....	14-4
Scanning a Document.....	14-4
TWAIN Compliant	14-4
Accessing the Scanner	14-5
Scanning a Document into the PC.....	14-5
Settings in the Scanner Window.....	14-6
Resolution:	14-6
Scan Type:.....	14-6
Brightness:	14-6
Contrast:	14-7
Size:.....	14-7
Custom:	14-7
PreScanning an Image	14-8
How to Use PreScan to Adjust an Image:.....	14-8

15

Setting Up and Using PC FAX (For Windows® Only)

Introduction	15-1
Brother Resource Manager.....	15-1
MFC Remote Setup	15-2
PC FAX Sending (For Windows® Only)	15-3
Setting Up User Information	15-3
Setting Up Sending.....	15-4

Outside Line Access	15-4
Include Header.....	15-4
Address Book File	15-4
User Interface	15-5
Simple Style	15-5
Facsimile Style.....	15-5
Setting Up Speed Dial	15-6
The Address Book	15-7
Setting Up a Member in the Address Book.....	15-8
Setting Up a Group for Broadcasting	15-9
Editing Member Information.....	15-9
Deleting a Member or Group	15-10
Exporting the Address Book	15-10
Importing to the Address Book	15-11
Setting Up a Cover Page.....	15-13
To	15-13
From.....	15-13
Comment.....	15-13
Select Cover Page Form.....	15-13
Import BMP file	15-14
Count Cover Page	15-14
Sending a File as a PC-FAX Using the Facsimile Style....	15-14
Redial	15-15
Sending a File as a PC-FAX Using the Simple Style.....	15-16

16

Using Automatic E-Mail Printing.....	16-1
For Windows® 95, 98, 98SE, Me Only	16-1
Main Features	16-1
To Access the On-Line Documentation.....	16-1
To Install Automatic E-mail Printing (Optional Application)	16-1

17

Using the Brother MFC with a New Power Macintosh® G3, G4 or iMac™/iBook™	17-1
Set Up Your USB-Equipped Apple® Macintosh® G3, G4 or iMac™ or iBook™ with Mac OS 8.5-9.2.....	17-1
Using Brother Printer Driver with Your Apple® Macintosh®	17-1
Sending a Fax from Your Macintosh® Application	17-3
Setting Up Your Address Book.....	17-5
Adding a New Member.....	17-5

Adding a New Group	17-6
Using Brother TWAIN Scanner Driver with Your Apple®	
Macintosh®	17-7
Accessing the Scanner	17-8
Scanning an Image into Your Macintosh G3, G4 or iMac ..	17-8
Settings in the Scanner Window	17-9
Image	17-9
Scanning Area	17-10
Business Card Size	17-10
Adjust Image	17-11
Color Sync Dialog	17-11
Scanner Profile	17-12
PreScanning an Image	17-13

18

Important Information	18-1
Standard Telephone and FCC Notices	18-1
Federal Communications Commission (FCC)	
Declaration of Conformity (For USA Only)	18-2
Important	18-3
Industry Canada Compliance Statement	
(For Canada Only)	18-3
International ENERGY STAR® Compliance	
Statement	18-3
Important Safety Instructions	18-4
Trademarks	18-5

19

Troubleshooting and Routine Maintenance	19-1
Troubleshooting	19-1
Error Messages	19-1
Original Jams and Paper Jams	19-3
Printer Jam or Paper Jam	19-4
If You Are Having Difficulty with Your MFC	19-7
How to Improve Print Quality	19-9
Cleaning the Print Heads	19-9
Print Quality Check	19-10
STEP A: Color Block Quality Check	19-10
STEP B: Alignment Check	19-11
Packing and Shipping the MFC	19-12
Routine Maintenance	19-15
Cleaning the Scanner	19-15
Cleaning the MFC Printer Platen	19-16

Replacing the Ink Cartridges	19-16
Specifications	S-1
Product Description	S-1
Fax	S-1
Printer	S-2
Printing	S-2
Controller	S-3
Computer Requirements	S-3
Print Media	S-4
Consumable Items	S-4
Glossary	G-1
Index	I-1
Remote Retrieval Access Card	R-1

1 Introduction

Using This Manual

Thank you for purchasing a Brother multi-function center (MFC). This MFC has been designed to be simple to use, with LCD screen prompts to guide you through programming your MFC. However, you can use your MFC to its fullest potential by taking a few minutes to read this manual.



Additionally, your MFC has a **Reports** key. Press **Reports** and **1** to print a list of basic operational steps.

Finding Information

All chapter headings and subheadings are listed in the Table of Contents. You will be able to find information about a specific feature or operation by checking the Index in the back of this manual.

Conventions Used in this Manual

Throughout this manual you'll see special symbols alerting you to important information, warnings, and actions to perform. For clarification, and to help you choose the correct key presses, we've added illustrations showing some of the LCD messages.

boldface	Bold typeface identifies a specific key on the MFC control panel.
<i>italics</i>	Italics typeface emphasize an important point, or refer you to related topic.
<code>bubble dot</code>	Bubble Dot typeface identifies the messages on the LCD of the MFC.



Warnings detail precautions you must take to avoid possible personal injury.



Cautions specify procedures you must follow or avoid to prevent possible damage to the MFC.



Notes tell you the proper response for a situation that may occur.



FYI tips provide details about how the current operation interacts with other features.



Improper Setup alerts you to devices and procedures that are not compatible with the MFC.

Test Sheet Procedure and Product Registration (For USA Only)

After programming your Station ID, please fill out the TEST SHEET included with your MFC, and then fax it to Brother's Automated Fax Response System as your first transmission. This will verify that your MFC is properly installed. To get a response, you must have set up your Station ID. (See *Setting Station ID*, page 4-2.)

In USA: 1-877-268-9575

When your TEST SHEET is received, a Confirmation Sheet and Product Registration form will be sent back to your MFC. Please fill out the form and return it to complete your registration.

To Complete Your MFC-5100C Registration On-Line

- 1** Insert the MFL Pro Suite CD-ROM into your CD-ROM drive.
- 2** Click **On-Line Registration** to register your product from the main menu.

MFC-5100C Control Panel Overview

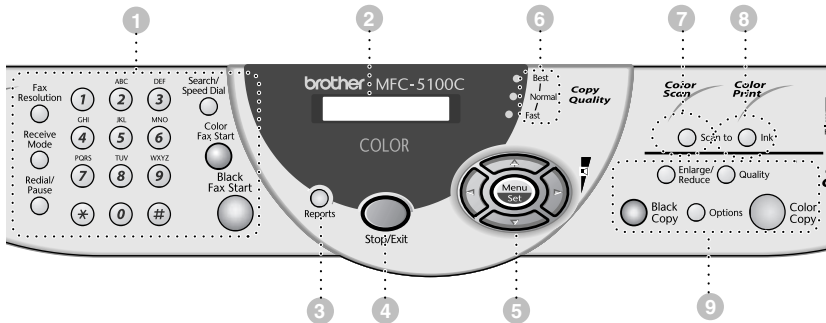

1 Fax Keys:

Fax Resolution

Sets the resolution when you send a fax.

Receive Mode

Use to select how the MFC will handle incoming calls.

Redial/Pause

Redials the last number called. Also inserts a pause in auto dial numbers.

Dial Pad

Use to dial phone and fax numbers and as a keyboard for entering information into the MFC.

(For Canada Only): The # key lets you switch the dialing type during a telephone call from **PULSE** to **TONE**.

Search/Speed Dial

Lets you look up numbers stored in the dialing memory. Also lets you dial stored phone numbers by pressing # and a two-digit number.

Color Fax Start

Starts sending a color fax.

Black Fax Start

Starts sending a black and white fax.

2 Liquid Crystal Display (LCD)

The LCD displays messages to help you set up and operate your MFC.

3 Reports

Accesses the Reports menu so you can select a report to print: Help List, Auto Dial, Fax Activity, Transmission Verification and User Settings.

4 Stop/Exit

Stops a fax, cancels an operation, or exits from Menu mode.

5 Navigation Keys:

Menu/Set

Lets you access the Menu and Programming mode and stores your settings in the MFC.



Press to scroll forward or backward to set a menu selection.

Also, you can use these keys to do an alphabetical search for the names of stored numbers.



Volume

Press to scroll through the menus and options.

When the machine is idle, you can press these keys to adjust the ring volume.

6 Copy Quality Indicator Lights

These lights show the copy quality you selected.

7 Scan Key:

Scan to

Lets you scan the next original into your computer and select the type of destination: word processing, graphics or E-mail application.

8 Print Key:

Ink

Cleans the ink print heads and replace an ink cartridge.

9 Copy Keys (Temporary Settings):

Enlarge/Reduce

Lets you reduce or enlarge copies depending upon the ratio you select.

Quality

Use this key to temporarily change the quality for Copy.

Options

You can quickly and easily select temporary settings.

Color Copy

Makes a full-color copy.

Black Copy

Makes a black-and-white copy.

About Fax Machines

If you're a first-time MFC user, fax operation might seem a little mysterious. Soon, you'll recognize the unusual fax tones on your phone line, and be able to send and receive faxes easily.

Custom Features

Do You Have Voice Mail on the Phone Line?

If you have Voice Mail on the phone line on which you will install your new MFC, *there is a strong possibility that Voice Mail and the MFC will conflict with each other while receiving incoming calls.*

Why Should There Be Trouble?

Since both MFCs and Voice Mail will pick up the line at the number of rings you have set, each of them has the ability to keep the other from receiving calls. For example, if your Voice Mail is set to answer after two rings and your MFC is set to answer after four, your Voice Mail will keep your MFC from receiving faxes. If you set Voice Mail and the Brother MFC to answer at the same number of rings, there is no way of knowing which one will answer first. It is important to remember that neither Voice Mail nor the MFC can pass the call back to the other after the call has been answered.

How Can You Avoid Possible Problems?

A very good way to avoid problems like the one mentioned previously is *to get a second phone number on your present phone line.* Many people with Voice Mail opt for this choice, which is called “Distinctive Ring”, and they are very satisfied with it. *For details about this type of custom service, please see Distinctive Ring, page 5-7.*

Another way to avoid possible problem is to replace your Voice Mail with an answering machine. Your Brother MFC is designed to work in tandem with an answering machine or TAD (telephone answering device). (See *Connecting an External Telephone Answering Device (TAD)*, page 2-13.)

Fax Tones and Handshake

When someone is sending a fax, the MFC sends fax calling tones (CNG tones) — soft, intermittent beeps at 4-second intervals. You'll hear them after you dial and press **Black Fax Start**; they continue for about 60 seconds after dialing. During that time, the sending machine must begin the “handshake” with the receiving machine. Each time you use automatic procedures to send a fax, you are sending CNG tones over the phone line. You'll soon learn to listen for these soft beeps each time you answer a phone on your fax line, so you can know if you are receiving a fax message.

The receiving fax responds with fax receiving tones—loud, chirping sounds. A receiving fax chirps for about 40 seconds over the phone line, and the LCD shows **RECEIVING**. If your MFC is set to the FAX mode, it will answer every call automatically with fax receiving tones. Even if the other party hangs up, your MFC continues to send the “chirps” for about 40 seconds, and the LCD continues to show **RECEIVING**. To cancel the receiving mode, press **Stop/Exit**.

The fax “handshake” is the time in which the sending machine’s CNG tones and the receiving machines “chirps” overlap. This must be for at least 2 to 4 seconds, so the machines can understand how each is sending and receiving the fax. The handshake cannot begin until the call is answered, and the CNG tones only last for about 60 seconds after the number is dialed. Therefore, it’s important for the receiving machine to answer the call in as few rings as possible.



When you have an external telephone answering device (TAD) on your fax line, your TAD will determine the number of rings before the call is answered. Pay special attention to the directions chapter for connecting a TAD to your MFC in Chapter 2, *Assembly and Connections*.

ECM (Error Correction Mode)

The Error Correction Mode (ECM) is a way for the MFC to check the integrity of a fax transmission while it is in progress. ECM transmissions are possible only between machines that both have the ECM feature. If they do, you may send and receive fax messages that are continuously checked for their integrity.

Sufficient memory must be available in your MFC for this feature to work.

2

Assembly and Connections

Packing List

Make sure you have the following items:

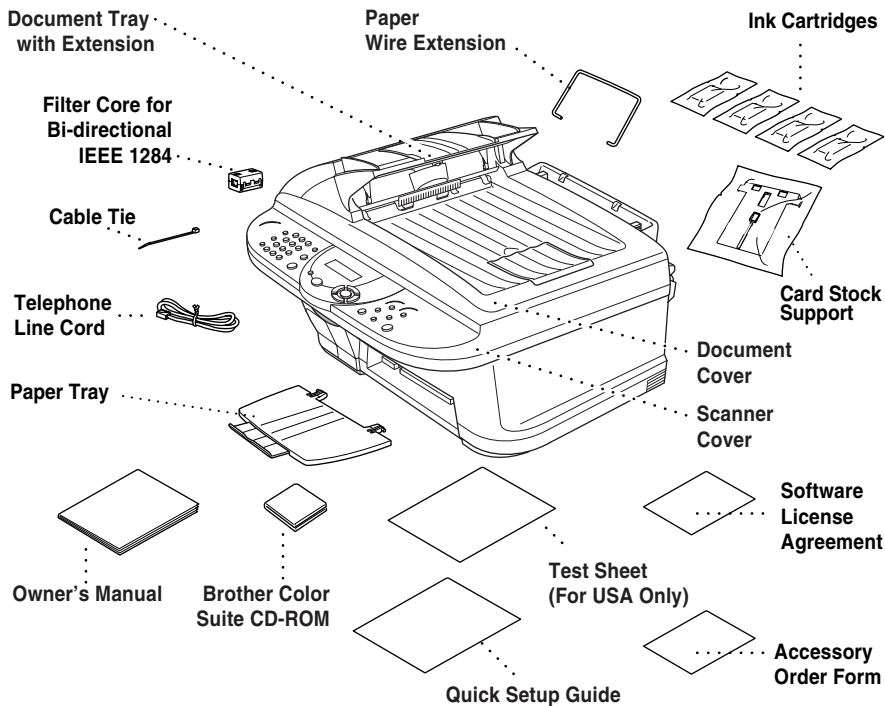

! Caution

Do NOT throw away the filter core and cable tie by accident. You will need them to meet FCC Emission Requirements when you connect the MFC to your computer using a bi-directional IEEE-1284 compliant parallel cable.



If an item is missing, call Brother Customer Service at 1-800-284-4329 (in USA), 1-877-BROTHER (in Canada) or 1-514-685-6464 (in Montreal). See *Ordering Accessories and Supplies* on page ii for the correct item numbers.

! Caution

Whenever you transport the MFC, use the packing materials that came with your MFC. If you do not pack the MFC correctly, you may void your warranty.

Choosing a Location

Place your MFC on a flat, stable surface, such as a desk. Select a place that is free of vibration and shocks. Locate the MFC near a telephone jack and a standard, grounded power outlet. Choose a location where the temperature remains between 50°F and 95°F (10°–35°C).

- ⊘ Avoid placing your MFC in a high-traffic area. Do not place near heaters, air conditioners, water, chemicals, or refrigerators. Do not expose the MFC to direct sunlight, excessive heat, moisture, or dust. Do not connect your MFC to electrical outlets controlled by wall switches or automatic timers. Disruption of power can wipe out information in the MFC's memory. Do not connect your MFC to electrical outlets on the same circuit as large appliances or other equipment that might disrupt the power supply. Avoid interference sources, such as speakers or the base units of cordless phones.

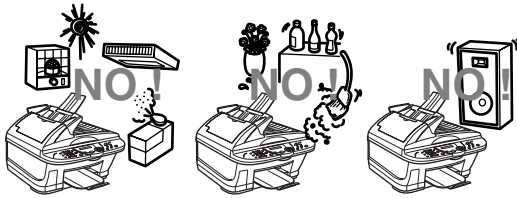

! WARNING

- Use caution when installing or modifying telephone lines. Never touch telephone wires or terminals that are not insulated unless the telephone line has been disconnected at the wall jack. Never install telephone wiring during a lightning storm. Never install a telephone jack in a wet location unless the jack is specifically designed for a wet location.
- Lightning and power surges can damage this product! We recommend that you use a quality surge protection device on the AC power line and on the telephone line, or unplug the lines during a lightning storm.
- For PLUG CABLE EQUIPMENT, the socket-outlet should be installed near the equipment and should be easily accessible.
- To reduce the risk of shock or fire, use only a No. 26 AWG or larger telecommunication line cord.

Important Safety Instructions

- 1 Do not use this product near appliances that use water, in a wet basement or near a swimming pool.
- 2 Avoid using a telephone other than a cordless type during an electrical storm. There may be a remote risk of electric shock from lightning.

Paper

The quality of your document can be affected by the kind of paper you use in the MFC. To ensure the best print quality for the settings you've chosen, always set the Paper Type to match the type of paper you load. You can use plain paper, inkjet paper (coated paper), glossy paper, transparencies and envelopes. We recommend testing various paper types before purchasing large quantities. For best results, use the recommended paper.

Note When you print on inkjet paper (coated paper), transparencies and glossy paper, be sure to select the correct media in the "Quality/Color" tab in the printer driver. When using inkjet paper, transparencies or glossy paper, avoid stacking by removing each page after it exits the machine.

Handling and Using Special Paper

- Store paper in the original bag, and keep it sealed. Keep the paper flat and away from moisture, direct sunlight and heat.
- The coated side of glossy paper is shiny. Do not touch the shiny (coated) side. Load glossy paper with the shiny side facing up toward you.
- Do not touch either side of transparencies, because they absorb water and perspiration easily, and may cause decreased output quality. Transparencies designed for laser printers/copiers may stain your next document. Use only recommended transparencies.

Recommended Paper for the MFC-5100C

Plain Paper: Xerox 4200
Inkjet Paper: KODAK® Premium Inkjet Paper (Matte)
Glossy Paper: JETPRINT PHOTO®
Graphic image paper — Gloss Finish
Transparencies: 3M Transparency Film (CG3410)

Note The output quality depends on the paper type and paper brand. Visit us at <http://solutions.brother.com> and check the latest recommendations for paper that can be used with the MFC-5100C.

Paper Capacity of Multi-Purpose Sheet Feeder

Paper Type	Paper Size	Capacity
Plain Paper (Cut Sheet)	Letter, Executive	100 Sheets of 20 lb (75 g/m ²)
	Legal	100 Sheets of 20 lb (75 g/m ²)
Inkjet Paper	Letter	20 Sheets
Glossy Paper*	Letter	20
Transparencies	Letter	10
Envelopes*	DL, COM-10, C5, Monarch	10
Postcard*	4" × 6"	30
Index Card*	5" × 8"	30

*If you want to load thick paper such as postcards, index cards, envelopes and glossy paper in the multi-purpose sheet feeder, you must first install the Card Stock Support in the feeder.

Paper Specifications for Multi-Purpose Sheet Feeder

Cut Sheet Paper Weight	Plain Paper: 17 to 32 lb (64 to 120 g/m ²) Inkjet Paper: Up to 32 lb (120 g/m ²) Glossy Paper: Up to 40 lb (150 g/m ²) Postcard: Up to 45 lb (170 g/m ²) Index card: Up to 32 lb (120 g/m ²)
Thickness	Plain Paper: 0.003 to 0.006 inches (0.08 to 0.15 mm) Inkjet Paper: Up to 0.006 inches (0.15 mm) Glossy Paper: Up to 0.007 inches (0.18 mm) Envelopes: Up to 0.02 inches (0.52 mm) Postcard: Up to 0.009 inches (0.23 mm) Index card: Up to 0.006 inches (0.15 mm)
Sheet Feeder	Up to 0.39 inches (10 mm) Approximately 100 sheets of 20 lb (75 g/m ²)
Output Stacker	Approximately 50 sheets of 20 lb (75 g/m ²) (Transparencies and glossy paper must be picked up from the paper tray one page at a time.)

Print Area

The print area depends on the settings in the application you are using. The figures below show the unprintable areas on cut sheet and envelopes.

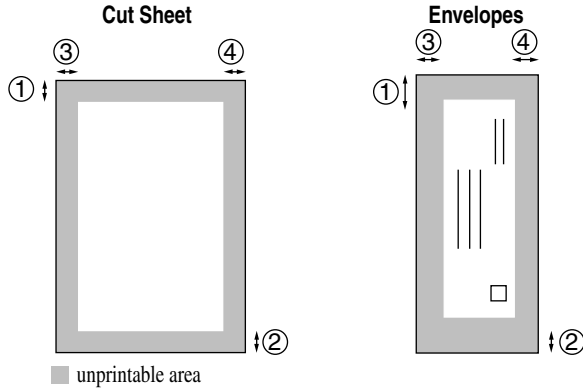

		(inch)				
Paper Type	Paper Size		1	2	3	4
Cut Sheet	Letter, Legal	Fax				
		Mono Copy	0.12	0.43	0.25	0.25
		Color Copy				
		Printer				
	A4	0.12				
	Fax					
	Mono Copy					
	Color Copy					
Printer						
Executive	Printer	0.12	0.43	0.13	0.13	
Envelopes	DL, C5, CM10, Monarch	Printer	0.39	0.79	0.13	0.13



Printer depends on the Printer driver.

The above figures are approximate and the print area may vary depending on the kind of paper you are using.



Do not use the following types of paper and envelopes:

- Damaged, curled, wrinkled, or irregularly shaped paper and envelopes
- Extremely shiny or highly textured paper and envelopes
- Envelopes with clasps
- Envelopes of baggy construction
- Envelopes not sharply creased
- Embossed envelopes
- Paper and envelopes already printed with a laser printer
- Envelopes preprinted on the inside
- Paper and envelopes that cannot be arranged uniformly when stacked

Assembly

Removing the Protective Yellow Bar

- 1 Lift the cover toward the back.

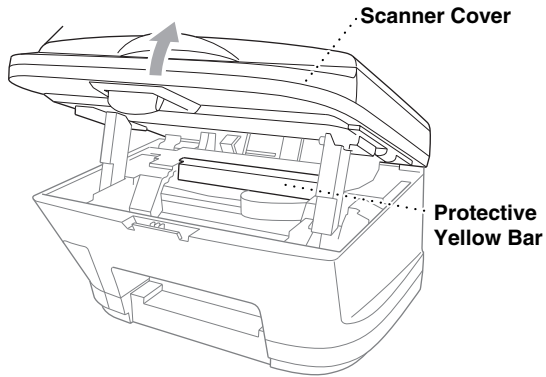

- 2 Pull the protective yellow bar out of the machine.

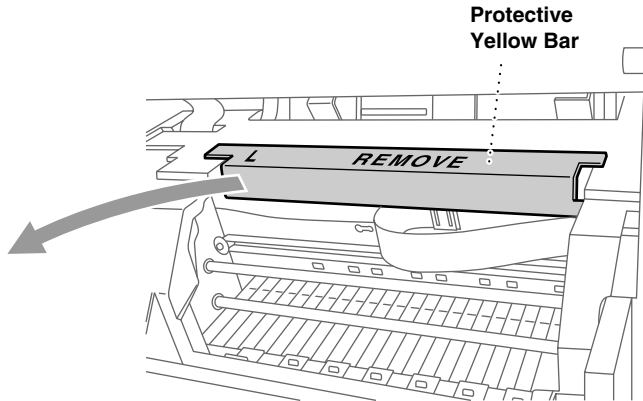

Caution

Do not throw away the protective yellow bar. You will need it for future transportation.

- 3 Close the top cover, and then close the control panel cover.

Setting up the MFC

1 Connect the power cord.

There is no ON/OFF switch. When you plug in the power cord, the power goes on and the LCD shows:

CHECK CARTRIDGE

! WARNING

- The MFC must be grounded using a 3-prong plug.
- Since the MFC is grounded through the power outlet, you can protect yourself from potentially hazardous electrical conditions on the telephone network by keeping the power to your MFC on when you connect it to a telephone line. Similarly, you can protect yourself when you want to move your MFC by disconnecting first the telephone line and then the power cord.
- Lightning and power surges can damage this product! We recommend that you use a quality surge protection device on the AC power line as well as on the telephone line, or unplug the lines during a lightning storm.

2 Connect the telephone line cord.

Connect one end of the telephone line cord to the jack on the MFC and the other end to a modular wall jack.

! Caution

Operating the MFC before you install the ink cartridges will permanently damage the print head.

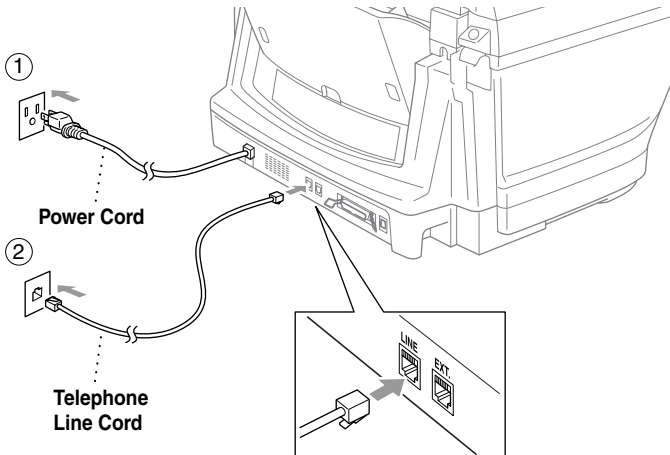

3 Attach the paper wire extension to the multi-purpose sheet feeder.

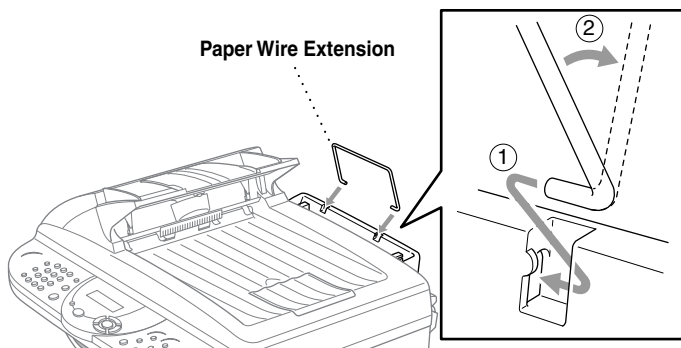

4 Attach the plastic paper tray to the paper output slot, and then pull out the extension.

! Caution

Please attach the paper tray to prevent paper jams and maintain print quality.

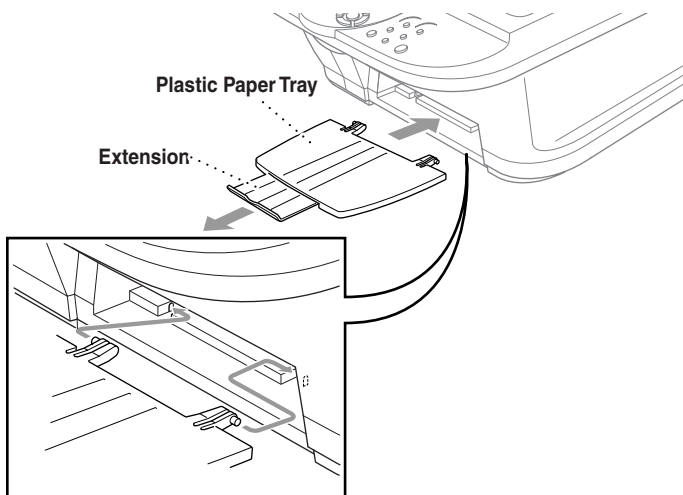

Loading Paper in the Multi-Purpose Sheet Feeder (Paper Cassette)

You can load up to 100 sheets of 20 lb (75 g/m²) paper if you use the cut sheet. (See *Paper Capacity of Multi-Purpose Sheet Feeder*, page 2-4.)

- 1 Fan the paper well. Gently insert the paper. Make sure the print side is toward you and the paper level is stacked below the paper guide line.

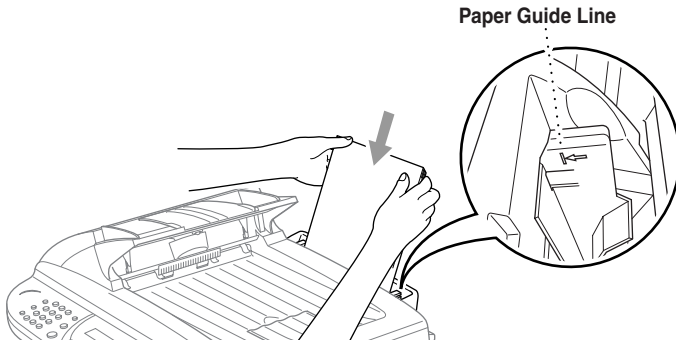

- 2 Press and slide the guide to fit the paper width.

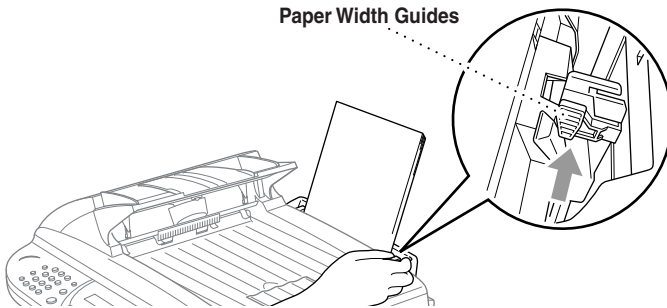

Installing the Ink Cartridges

- 1 Check that you turned on the power (by plugging in the power cord). The LCD shows: 
- 2 Open the Scanner cover of the MFC by pulling the scanner cover release lever toward you and lifting the scanner cover.
- 3 After a few seconds, the print head will move left to its replacement position.

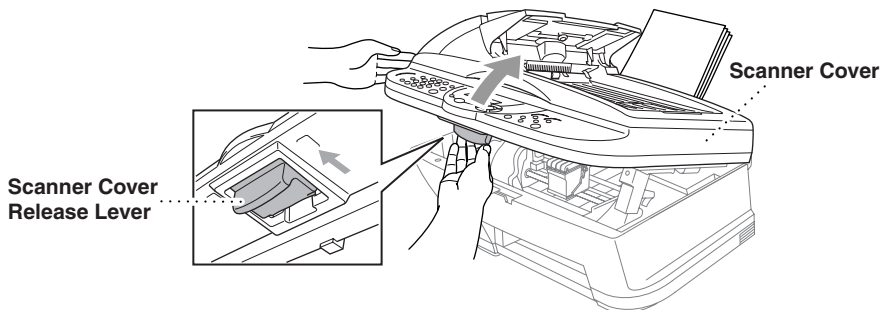

- 4 Remove the protective blue tape over the colored ink cartridge covers.
- 5 Push the four colored ink cartridge covers one at a time so they pop up. Then remove the white shipping cover by pulling it toward you and lifting it up and out.

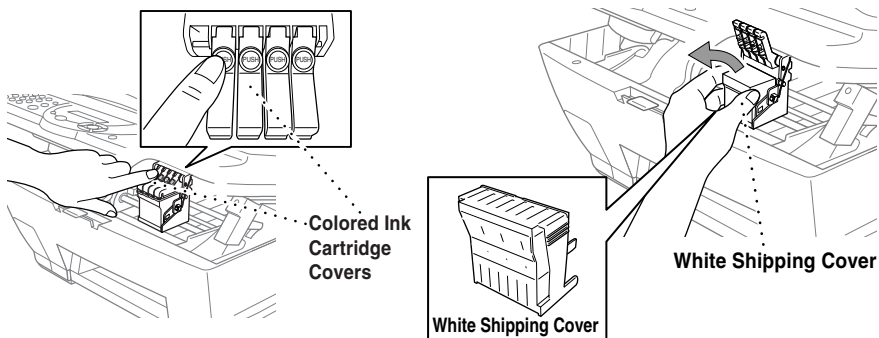

WARNING

If ink gets in your eyes irrigate them with water immediately, and if irritation occurs consult a doctor.

Caution

- The bottom of the white shipping cover is wet with ink that will cause stains, so wipe it clean before you place it down.

- Do not throw away the white shipping cover. You will need it for future transportation.

We recommend that you install the ink cartridges from left to right in this order: Black, Cyan, Yellow, Magenta.

- 6 Open the Black ink cartridge bag and take out the ink cartridge.
- 7 Carefully remove the sealing tape from the bottom of the ink cartridge. Be sure to peel the tape in the direction *away* from you.

Important

To prevent spilling ink and staining your hands and clothing, peel the sealing tape gently and slowly. Do not touch the ink opening on the cartridge or the removed tape.

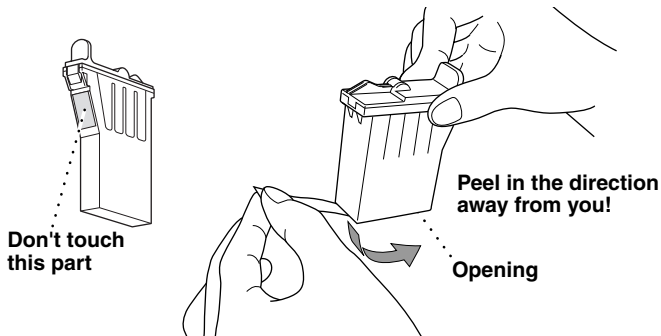

- 8 Each color has its own correct position. Match the colors of the ink cartridge covers. First, gently insert the Black ink cartridge, and then press the cover down until it clicks.

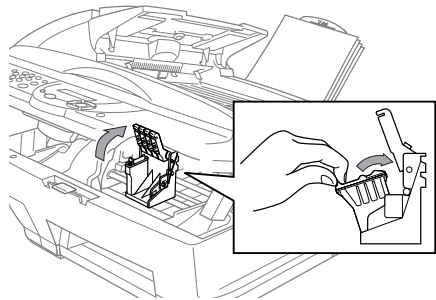

- 9 Repeat Steps 6 to 8 to install each color ink cartridge.
- 10 After installing all ink cartridges, close the Scanner cover until it clicks into place. Your MFC will enter a “head cleaning” cycle for approximately four minutes.

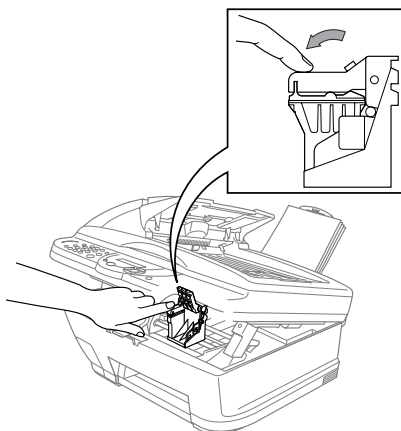

! Caution

Make sure the paper is loaded in the multi-purpose sheet feeder. The LCD shows **CLEANING**. After the cleaning cycle is finished, the LCD shows **PRESS FAX START**.

- 11 Press **Black Fax Start**. The MFC starts printing the Print Quality Check Sheet (only during initial ink cartridge installation).

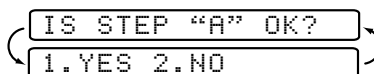

The LCD shows:

- 12 Follow the instructions printed on the sheet.

! Caution

- DO NOT remove ink cartridges if you do not need to replace them. If you do so, it may reduce the ink quantity and the MFC will not know the quantity of ink left in the cartridge.
- DO NOT shake the ink cartridges. If you do so, the ink may spill when you take off the sealing tape. If ink stains your body or clothing, wash with soap or detergent immediately.
- If you mix the colors by installing an ink cartridge in the wrong color position, you must clean the print head several times after correcting the cartridge installation and before you start printing.
- Once you open an ink cartridge, install it in the MFC and use it up within six months of installation. Use unopened ink cartridges by the expiration date written on the cartridge package.
- DO NOT refill the ink cartridges. Attempting to use refilled cartridges and using incompatible inks may cause damage to the print head in this machine and such damage will not be covered by warranty. Warranty coverage does not apply to problems caused by the use of 3rd party ink or 3rd party ink cartridges. Use only genuine Brother ink cartridges.



If **INK EMPTY** shows on the LCD after you install the ink cartridges, check to make sure the ink cartridges are installed correctly.

Connecting the MFC

Connecting an External Telephone

Although your MFC does not have a handset, you can connect a separate telephone (or telephone answering device) directly to your MFC.

Connect the modular plug on the telephone's line cord to the jack labeled **EXT.** on the left side of the MFC.

Whenever this phone (or TAD) is in use, the LCD shows **TELEPHONE**.

Connecting an External Telephone Answering Device (TAD)

Sequence

You may choose to connect an answering system. However, when you have an **external TAD** on the same telephone line as the MFC, the TAD answers all calls and the MFC "listens" for fax calling (CNG) tones. If it hears them, the MFC takes over the call and receives the fax. If it doesn't hear CNG tones, the MFC lets the TAD continue playing your outgoing message so your caller can leave you a voice message.

The TAD must answer within five rings (the recommended setting is two rings). The MFC cannot hear CNG tones until the TAD has answered the call, and with five rings there are only 8 to 10 seconds of CNG tones left for the fax "handshake." Make sure you carefully follow the instructions in this manual for recording your outgoing message. We do not recommend using the toll saver feature on your external answering machine if it exceeds five rings.



If you do not receive all your faxes, you must reset the setting on your external TAD to four rings.



If You Subscribe to your Telephone Company's Distinctive Ring Service:

You may connect an external TAD to a separate wall jack *only* if you subscribe to your telephone company's Distinctive Ring service, have registered the distinctive ring pattern on your MFC, use that number as a fax number and set your machine's Receive mode to **MANUAL**. The recommended setting is three or four rings on the external TAD when you have the telephone company's Distinctive Ring Service.



If You Do Not Subscribe to Distinctive Ring Service:

You *must* plug your TAD into the **EXT.** jack of your MFC. If your TAD is plugged into a wall jack, both your machine and the TAD will try to control the phone line. (See illustration, page 2-14.)

- ⊘ **Do not connect a TAD elsewhere on the same phone line** (unless you have the Distinctive Ring service).

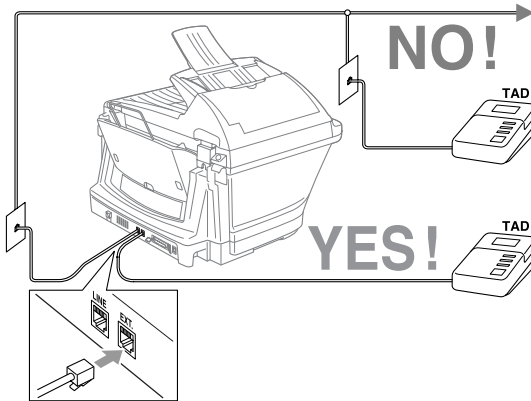

Connections

The external TAD **must** be plugged into the back side of the MFC, into the jack labeled EXT. Your MFC cannot work properly if you plug the TAD into a wall jack (unless you are using Distinctive Ring).

- 1 Plug the telephone line cord from the wall jack into the back side of the MFC, in the jack labeled LINE.
- 2 Plug the telephone line cord from your external TAD into the back side of the MFC, in the jack labeled EXT. (Make sure this cord is connected to the TAD at the TAD's telephone line jack, and not its telephone set jack.)
- 3 Set your external TAD to four rings or less. (The MFC's Ring Delay setting does not apply.)
- 4 Record the outgoing message on your external TAD.
- 5 Set the TAD to answer calls.
- 6 Set the Receive Mode to **EXT. TEL/TAD**.
(See *Choosing the Receive Mode*, page 5-1)

Recording Outgoing Message (OGM)

Timing is important in recording this message. The message sets up the ways to handle both manual and automatic fax reception.

- 1 Record 5 seconds of silence at the beginning of your message. (This allows your MFC time to listen for the fax CNG tones of automatic transmissions before they stop.)
- 2 Limit your speaking to 20 seconds.

- 3 End your 20-second message by giving your Fax Receive Code for people sending manual faxes. For example:
“After the beep, leave a message or send a fax by pressing * 51 and Start.”



We recommend beginning your OGM with an initial 5-second silence because the MFC cannot hear fax tones over a resonant or loud voice. You may try omitting this pause, but if your MFC has trouble receiving, then you must rerecord the OGM to include it.

Special Line Considerations

Roll Over Phone Lines

A roll over phone system is a group of two or more separate telephone lines that pass incoming calls to each other if they are busy. The calls are usually passed down or “rolled over” to the next available phone line in a preset order.

Your MFC can work in a roll over system as long as it is the last number in the sequence, so the call cannot roll away. Do not put the MFC on any of the other numbers; when the other lines are busy and a second fax call is received, the fax call would be transferred to a line that does not have a fax machine. **Your MFC will work best on a dedicated line.**

Two-Line Phone System

A two-line phone system is nothing more than two separate phone numbers on the same wall outlet. The two phone numbers can be on separate jacks (RJ11) or combined into one jack (RJ14). Your MFC must be plugged into an RJ11 jack. RJ11 and RJ14 jacks may be equal in size and appearance and both may contain four wires (black, red, green, yellow). To test the type of jack, plug in a two-line phone and see if it can access both lines. If it can, you must separate the line for your MFC. (See *Easy Receive*, page 5-3.)

Converting Telephone Wall Outlets

There are three ways to convert to an RJ11 jack. The first two ways may require assistance from the telephone company. You can change the wall outlets from one RJ14 jack to two RJ11 jacks. Or, you can have an RJ11 wall outlet installed and slave or jump one of the phone numbers to it.

The third way is the easiest: Buy a triplex adapter. You can plug a triplex adapter into an RJ14 outlet. It separates the wires into two separate RJ11 jacks (Line 1, Line 2) and a third RJ14 jack (Lines 1 and 2). If your MFC is on Line 1, plug the MFC into L1 of the triplex adapter. If your MFC is on Line 2, plug it into L2 of the triple adapter.

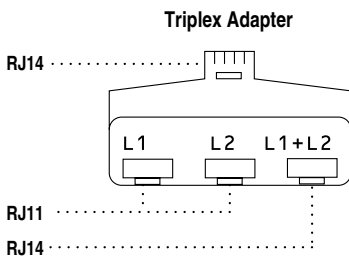

Installing MFC, External Two-Line TAD and Two-Line Telephone

When you are installing an **external** two-line telephone answering device (TAD) and a two-line telephone, your MFC must be isolated on one line at both the wall jack and at the TAD. *The most common connection is to put the MFC on Line 2, which is explained in the following steps.* The back of the two-line TAD must have two telephone jacks: one labeled L1 or L1/L2, and the other labeled L2. You will need at least three telephone line cords, the one that came with your MFC and two for your external two-line TAD. You will need a fourth line cord if you add a two-line telephone.

- 1 Place the two-line TAD and the two-line telephone next to your MFC.
- 2 Plug one end of the telephone line cord for your MFC into the L2 jack of the triplex adapter. Plug the other end into the LINE jack on the left side of the MFC.
- 3 Plug one end of the first telephone line cord for your TAD into the L1 jack of the triplex adapter. Plug the other end into the L1 or L1/L2 jack of the two-line TAD.

- 4 Plug one end of the second telephone line cord for your TAD into the L2 jack of the two-line TAD. Plug the other end into the EXT. jack on the left side of the MFC.

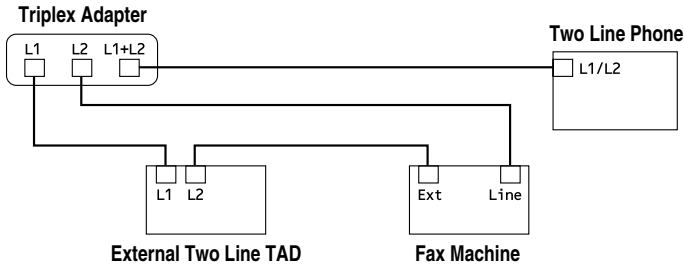

You can keep two-line telephones on other wall outlets as always. There are two ways to add a two-line telephone to the MFC's wall outlet. You can plug the telephone line cord from the two-line telephone into the L1+L2 jack of the triplex adapter. Or, you can plug the two-line telephone into the TEL jack of the two-line TAD.

Multi-Line Connections (PBX)

Most offices use a central telephone system. While it is often relatively simple to connect the machine to a key system or a PBX (Private Branch Exchange), we suggest that you contact the company that installed your telephone system and ask them to connect the MFC for you. It is advisable to have a separate line for the MFC. You can then leave the MFC in FAX mode to receive faxes any time of day or night.

If the MFC is to be connected to a multi-line system, ask your installer to connect the unit to the last line on the system. This prevents the unit from being activated each time a telephone call is received.

- ⊘ As with all fax units, this machine must be connected to a two wire system. If your line has more than two wires, proper connection of the MFC cannot be made.

If You are Installing the MFC to Work with a PBX

- 1 It is not guaranteed that the unit will operate correctly under all circumstances with a PBX. Any cases of difficulty should be reported first to the company that handles your PBX.
- 2 If all incoming calls will be answered by a switchboard operator, it is recommended that the Receive Mode be set to MANUAL. All incoming calls should initially be regarded as telephone calls.
- 3 The MFC may be used with either pulse or tone dialing telephone service (For Canada only).

Custom Features on Your Phone Line

If you have Voice Mail, Call Waiting, Caller ID, Caller Waiting/Caller ID, RingMaster, an answering service, an alarm system or other custom feature on one phone line it may create a problem with the operation of your MFC. (See *Custom Features on a Single Line*, page 19-8.)

3

On-Screen Programming

User-Friendly Programming

We have designed your MFC with on-screen programming using navigation keys. User-friendly programming helps you take full advantage of all the menu selections your MFC has to offer.

Since your programming is done on the LCD, we created step-by-step on-screen prompts to help you program your MFC. All you need to do is follow the prompts as they guide you through the menu selections and programming options. Additionally, you can program settings more quickly by pressing **Menu/Set** and the menu number using the dial pad.

Menu Selection Table

You can probably perform most of these programming operations without the Owner's Manual. To help you understand the menu selections, and options that are found in the MFC programs, use the Menu Selection Table on page 3-3.



You can program your MFC by pressing **Menu/Set** followed by the menu numbers. For example: to set **FAX RESOLUTION** to **FINE**,

press **Menu/Set, 2, 2, 2** and  to select **FINE**, and then press **Menu/Set**.





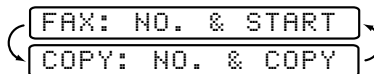

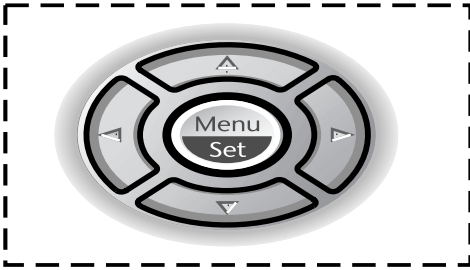

Alternating Displays

Sometimes, the LCD alternates between the active setting, and a help message giving brief instructions about how to proceed. The display you'll probably see most often is shown below. When you place an original in the ADF (Automatic Document Feeder), it appears to tell you that you can dial a number and send a fax, or you can make a copy.



Navigation Keys



-  * Access the Menu
-  * Go to next menu level
-  * Accept an option
-  * Scroll through the current menu level
-  * Back to previous menu level
-  * Forward to next menu level
-  * Exit the Menu
-  * Exit the Menu

You can access the menu mode by pressing **Menu/Set**. When you enter the Menu, the LCD scrolls;

Then press **1** for General Setup Menu—**OR**—

Press **2** for Fax Menu—**OR**—

Press **3** for Copy Menu—**OR**—

Press **4** for Test Print

—**OR**—

You can scroll more quickly through the each menu level by pressing , and then set an option by pressing **Menu/Set** when that option appears on the LCD.

Then the LCD shows next menu level. Press  to scroll to your next menu selection, and then press **Menu/Set**.

When you finish setting an option, the LCD shows **ACCEPTED**.

SELECT ↑ ↓ & SET

1. GENERAL SETUP

2. FAX

3. COPY

4. TEST PRINT



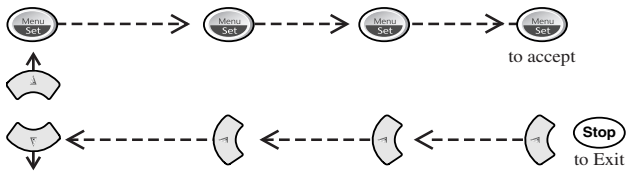

Use  to scroll backward if you passed your choices or to save keystrokes.

To access the menu, press  **Menu/Set**.



Main Menu	Submenu	Menu Selections	Options	Descriptions	Page
1. GENERAL SETUP	1. PAPER TYPE	—	PLAIN INKJET GLOSSY (4-COLOR/ 3-COLOR) TRANSPARENCY	Identifies the type of paper in the cassette.	4-1
	2. PAPER SIZE	—	LETTER LEGAL A4	Selects size of paper.	4-1
	3. DATE/TIME	—	—	Enter date and time for the LCD display and heading on fax transmissions.	4-2
	4. STATION ID	—	—	Program your name, fax number to appear on each transmitted page.	4-2
	5. VOLUME	1. RING	OFF	Adjusts ring volume.	4-4
			HIGH LOW		
	5. VOLUME	2. BEEPER	OFF	Adjusts volume level of beeper.	4-5
			HIGH LOW		
6. AUTO DAYLIGHT	—	ON OFF	Changes for Daylight Savings Time automatically.	4-5	
7. TONE/ PULSE (Canada Only)	—	TONE PULSE	Selects dialing mode	4-5	
8. LOCAL LANGUAGE (Canada Only)	—	ENGLISH FRENCH	Allows you to change the LCD Language to French.	See French Manual	

 The factory setting (option) is shown in bold.

To access the menu, press  **Menu/Set**.

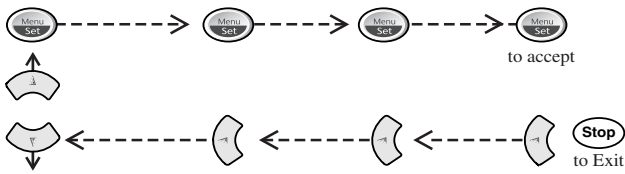

Main Menu	Submenu	Menu Selections	Options	Descriptions	Page	
2. FAX	1. SETUP RECEIVE	1. RING DELAY	05 04 03 02 01 00	↑ ↓	Number of rings before MFC answers in FAX ONLY mode.	5-2
		2. EASY RECEIVE	ON OFF	↑ ↓	Receive fax messages without pressing the Start key.	5-3
		3. REMOTE CODE	ON (* 51) OFF	↑ ↓	Activate the fax machine from a remote location. You can also personalize these codes.	5-4
		4. AUTO REDUCTION	ON OFF	↑ ↓	Reduces size of image.	5-3
		5. POLLING RX	ON OFF	↑ ↓	Sets up your MFC to poll another fax machine.	5-5
	2. SETUP SEND	1. CONTRAST	AUTO S.LIGHT S.DARK	↑ ↓	Changes lightness or darkness of a fax you are sending.	6-4
		2. FAX RESOLUTION	STANDARD FINE S. FINE PHOTO	↑ ↓	Changes the default setting of fax resolution.	6-4
		3. DELAYED FAX	—		Sends documents later.	6-8
		4. BATCH TX	ON	↑ ↓	Sends all delayed faxes that are to the same fax number and at the same time as one transmission.	6-8
			OFF			

 The factory setting (option) is shown in bold.

To access the menu, press  **Menu/Set**.

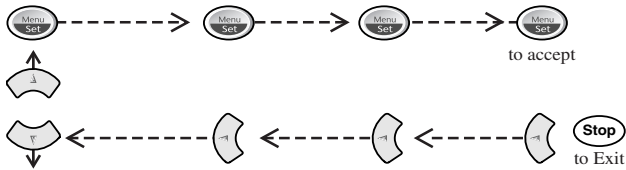

Main Menu	Submenu	Menu Selections	Options	Descriptions	Page	
2. FAX (Continued)	2. SETUP SEND (continued)	5. REAL TIME TX	OFF ON NEXT FAX ONLY	 	You can send a fax without using memory.	6-6
		6. POLLED TX	ON	 	Sets up your MFC with a document to be retrieved by another fax machine.	6-9
			OFF	 		
	3. SET AUTO DIAL	1. SPEED- DIAL	ON	 	Ajusts for sometimes difficult overseas transmissions.	6-7
			OFF	 		
	4. SETUP REPORTS	1. TRANS- MISSION	ON+IMAGE	 	Initial setup for Transmission Verification Report and Activity Report.	9-1
			OFF OFF+IMAGE	 		
	5. REMOTE FAX OPT	1. FAX FWD/ PAGING	OFF	 	Sets MFC to forward fax messages— OR —to call your pager.	8-1
			FAX FORWARD PAGING	 		
			ON	 		
2. FAX STORAGE	ON	ON	 	Stores incoming faxes in memory for remote retrieval.	8-2	
		OFF	 			
3. REMOTE ACCESS	159		Personalizes code for retrieving faxes.	8-3		

 The factory setting (option) is shown in bold.

To access the menu, press  **Menu/Set**.

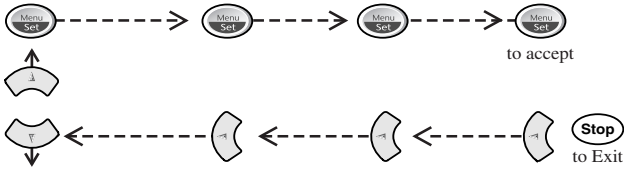

Main Menu	Submenu	Menu Selections	Options	Descriptions	Page
2. FAX (Continued)	5. REMOTE FAX OPT (continued)	4. PRINT FAX	—	Prints incoming faxes stored in the memory.	5-4
	6. REMAINING JOBS	—	—	Checks which jobs are in memory or cancel a delayed fax or polling job.	5-6, 6-7
	0. TEL SERVICE	1. DISTINCTIVE	ON OFF SET	↑ Uses the phone company Distinctive Ring subscriber service to register the ring pattern with the MFC. ↓	5-7
3. COPY	1. QUALITY	—	NORMAL BEST FAST	↑ Select copy quality. ↓	10-9
	2. COLOR ADJUST	1. RED	↑ R: - ■■■■ + R: - ■■■■ + R: - ■■■■ + R: - ■■■■ + R: - ■■■■ +	↑ Adjust the amount of Red in copies. ↓	10-10
		2. GREEN	↑ G: - ■■■■ + G: - ■■■■ + G: - ■■■■ + G: - ■■■■ + G: - ■■■■ +	↑ Adjust the amount of Green in copies. ↓	10-10
		3. BLUE	↑ B: - ■■■■ + B: - ■■■■ + B: - ■■■■ + B: - ■■■■ + B: - ■■■■ +	↑ Adjust the amount of Blue in copies. ↓	10-10
	3. CONTRAST	—	· - ■■■■ + · - ■■■■ + · - ■■■■ + · - ■■■■ + · - ■■■■ +	↑ Adjust the contrast. ↓	10-10
4. TEST PRINT	—	—	You can print a test sample page to check print quality and adjust the Vertical Alignment.	19-10	

 The factory setting (option) is shown in bold.

4 Initial Setup

Getting Started

Setting Paper Type

You can choose the Paper Type you use.

- 1 Press **Menu/Set**, **1**, **1**.

1. PAPER TYPE

- 2 Press  select **PLAIN, INK JET**, **GLOSSY** or **TRNSPRNCY** (TRANSPARENCY), and then press **Menu/Set**.

- 3 If you selected **GLOSSY**, press  to select **GLOSSY:4-COLOR** or **GLOSSY:3-COLOR**, and then press **Menu/Set**.

 **Note** The print quality of black ink varies depending on the kind of glossy paper you are using. Black ink is used when you select **GLOSSY:4-COLOR**. If the glossy paper you are using repels the black ink, select **GLOSSY:3-COLOR**, which simulates black ink by combining the three ink colors.

- 4 Press **Stop/Exit**.

 **Note** The MFC ejects paper with printed surfaces face up onto the paper tray in the front of the MFC. When you use transparencies, remove each sheet immediately to prevent a paper jam or curled.

Setting Paper Size

You can use three sizes of paper for printing your faxes and copies — letter, legal and A4. When you change the kind of paper you have loaded in the MFC, you will need to change the setting for Paper Size so your MFC can fit the incoming fax on the page.

- 1 Press **Menu/Set**, **1**, **2**.

2. PAPER SIZE





- 2 Press  to select **LETTER, LEGAL** or **A4**, and then press **Menu/Set**.

- 3 Press **Stop/Exit**.

Setting Date and Time

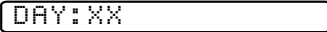

Your MFC displays the date and time, and prints it on every fax you send.

In the event of a power failure, you may have to reset the date and time. All other settings remain unaffected.

- 1 Press **Menu/Set, 1, 3.** 
- 2 Enter the last two digits of the year, and then press **Menu/Set.** 
- 3 Enter two digits for the month (for example, enter 09 for September, or 10 for October), and then press **Menu/Set.** 
- 4 Enter two digits for the day (for example, 06), and then press **Menu/Set.** 
- 5 Enter the time in 24-hour format (for example, enter 15:25 for 3:25 P.M.), and then press **Menu/Set.** 
- 6 Press **Stop/Exit.**
The LCD now displays the date and time you set whenever the MFC is in Standby mode.

Setting Station ID

You should store your name and fax number to be printed on all fax pages that you send.

- 1 Press **Menu/Set, 1, 4.** 
- 2 Enter your fax number (up to 20 digits), and then press **Menu/Set.**
You must enter a fax number to proceed. 
- 3 Use the dial pad to enter your name (up to 20 characters), and then press **Menu/Set.** (See *Entering Text*, page 4-3.) 
- 4 Press **Stop/Exit.**
The LCD returns to the date and time.



If your Station ID has already been programmed, the LCD prompts 1 to make a change or 2 to exit without changing.

Entering Text

When you are setting certain functions, such as the Station ID, you may need to type text into the MFC. Most number keys have three or four letters printed above them. The keys for 0, #, and ✖ do not have printed letters because they are used for special characters.

By pressing the appropriate number key repeatedly, you can access the character you want.

Press Key	one time	two times	three times	four times
2	A	B	C	2
3	D	E	F	3
4	G	H	I	4
5	J	K	L	5
6	M	N	O	6
7	P	Q	R	7
8	T	U	V	8
9	W	X	Y	9

Inserting Spaces

To enter a space, press  once between numbers and twice between characters.



Making Corrections

If you entered a letter incorrectly and want to change it, press  to move the cursor after the last correct letter. Then press **Stop/Exit**; all letters above and to the right of the cursor will be deleted. Re-enter the correct characters. You can also back up and type over incorrect letters.

Repeating Letters

If you need to enter a character that is assigned to the same key as the previous character, press  to move the cursor to the right.

Special Characters and Symbols

Press ✖, # or 0, and then press  or  to move the cursor under the special character or symbol you want. Then press **Menu/Set** to select it.

Press ✖ for (space) ! “ # \$ % & ’ () * + , - . /

Press # for ; : < = > ? @ [] ^ _

Press 0 for É À È Ê Î Ç Ë Ö 0

NOTICE

The Telephone Consumer Protection Act of 1991 makes it unlawful for any person to use a computer or electronic device to send any message via a telephone fax machine unless such messages clearly contain, in a margin at the top or bottom of each transmitted page, or on the first page of the transmission, the date and time it is sent and an identification of the business or other entity or other individual sending the message and the telephone number of the sending machines or such business, other entity or individual.

In order to program this information into your fax machine, complete the steps described on page 4-2.



If you do not enter a fax number, no additional information can be entered.

Setting the Ring Volume

- 1 Press **Menu/Set**, **1**, **5**, **1**.

1. RING

- 2 Press  select (**OFF**, **LOW**, or **HIGH**), and then press **Menu/Set**.

- 3 Press **Stop/Exit**.

—OR—

You can adjust the ring volume when your MFC is idle. You can turn the ring **OFF** or you can select a ring volume level.

Press  to adjust the volume level. With each key press, the MFC rings so you can hear the active setting as the LCD shows it. Each key press changes the volume. The new setting will remain until you change it again.

Setting the Beeper Volume

You can set the beeper to **LOW**, **HIGH** or **OFF**. The default setting is **LOW**. When the beeper is set to **LOW** or **HIGH**, the MFC beeps every time you press a key or make an error and when fax sending or receiving is finished.

- 1 Press **Menu/Set**, **1**, **5**, **2**.

2. BEEPER

- 2 Press  to select your option.

- 3 When the LCD shows the option you want, press **Menu/Set**.

Press **Stop/Exit**.

Turning On Automatic Daylight Savings Time

You can set the machine to change automatically for Daylight Savings Time. It will reset itself forward one hour in the Spring and backward one hour in the Fall.

- 1 Press **Menu/Set**, **1**, **6**.

6. AUTO DAYLIGHT

- 2 Press  to select **ON** (or **OFF**), and then press **Menu/Set**.

- 3 Press **Stop/Exit**.

Setting Tone/Pulse Dialing Mode (For Canada Only)

Your MFC comes set to accommodate tone dialing service (multi-frequency). If you have pulse dialing service (rotary), you need to change the dialing mode.

- 1 Press **Menu/Set**, **1**, **7**.

7. TONE/PULSE

- 2 Press  to select **PULSE** (or **TONE**), and then press **Menu/Set**.

- 3 Press **Stop/Exit**.

Memory Storage

In the event of a power failure, all settings in the **GENERAL SETUP**, **SETUP RECEIVE**, **SET AUTO DIAL** and **REMOTE FAX OPT** are stored permanently. You may have to reset the date and time.

5 Setup Receive

Basic Receiving Operations

Choosing the Receive Mode

There are three different receive modes for your MFC. You may choose the mode that best suits your needs by pressing **Receive Mode** repeatedly until the LCD shows the setting you want to use.

LCD	How it works	When to use it
FAX ONLY (automatic receive)	The MFC automatically answers every call as a fax.	For dedicated fax lines.
EXT.TEL/TAD (External telephone/ External Telephone Answering Device)	<p>If an external telephone is connected to the EXT. jack, you control the phone line and must answer every call yourself.</p> <p>If an external TAD (telephone answering device) is connected to the EXT. jack, the TAD automatically answers every call. Voice messages are stored in the external TAD. Fax messages are printed.</p>	<p>Use this mode if you receive very few faxes.</p> <p>Use this mode if you have an external answering machine on your phone line.</p>
MANUAL (manual receive)	You control the phone line and must answer every call yourself.	Use this mode when you are using a computer modem on the same line or if you receive very few fax messages.

To Select or Change Your Receive Mode

- 1 Press **Receive Mode**. The LCD shows your current selection.

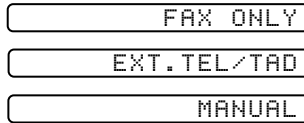

- 2 Continue to press **Receive Mode** until your new selection appears. After two seconds the LCD returns to the date and time display, along with your new Receive Mode setting.



If you are changing the Receive Mode while in another operation, the LCD returns to that operation.

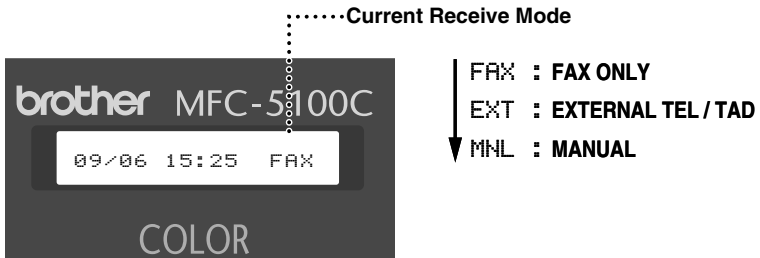

Setting Ring Delay

The Ring Delay setting determines the number of times the MFC rings before it answers. If you have extension phones on the same line as the MFC or subscribe to the telephone company's Distinctive Ring service, keep the Ring Delay default setting of 4. You can try setting the Ring Delay to 5 rings; however, if you do not receive all your faxes, you must reset it to 4 rings.

(See *Easy Receive*, page 5-3 and *Operation from Extension Telephone*, page 5-4.)

- 1 Press **Menu/Set**, **2**, **1**, **1**.



- 2 Press  to select how many times the line rings before the MFC answers (00–05), and then press **Menu/Set**. If you select 00, the line doesn't ring at all.
- 3 Press **Stop/Exit**.

Easy Receive

When you use this feature, you don't have to press **Black Fax Start** when you answer a fax call. Selecting **ON** allows the MFC to receive fax calls automatically, even if you lift the handset of an extension or external phone. When you see **RECEIVING** on the LCD or when you hear "chirps" through the handset of an extension phone connected to another wall jack, just replace the handset, and your MFC does the rest. Selecting **OFF** means you'll have to activate the MFC yourself, by lifting the handset of an external or extension phone, and then pressing **Black Fax Start** on the MFC—**OR**—by pressing *** 5 1** if you are not at your MFC. (See *Operation from Extension Telephone*, page 5-4.)

 If this feature is set to **ON**, but your MFC doesn't automatically connect a fax call when you lift a phone handset, press the Fax Receive code *** 5 1**.

 If you send faxes from a computer on the same phone line and the MFC intercepts them, set Easy Receive to **OFF**.

1 Press **Menu/Set, 2, 1, 2**.

2.EASY RECEIVE

2 Use  to select **ON** (or **OFF**), and then press **Menu/Set**.

3 Press **Stop/Exit**.

Printing a Reduced Incoming Fax (Auto Reduction)

You can always reduce the size of an incoming fax to a fixed percentage, regardless of the size of the paper in your MFC. **ON** lets your MFC choose the level of reduction for you.

1 Press **Menu/Set, 2, 1, 4**.

4.AUTO REDUCTION

2 Use  to select **ON** (or **OFF**), and then press **Menu/Set**.

3 Press **Stop/Exit**.

 If incoming faxes show that information in the left and right margins has been cut off, make sure this Auto Reduction feature is turned on.

Advanced Receiving Operations

Operation from Extension Telephone

If you answer a fax call on an extension phone or on an external phone in the EXT. jack, you can make your MFC take over by using the Fax Receive Code. When you press the Fax Receive Code ✕ 5 1, the MFC starts to receive a fax. (See *Easy Receive*, page 5-3.)

If you answer a call at an extension or external phone, and no one is on the line, assume you're receiving a fax. At an extension phone, press ✕ 5 1, wait for fax receiving tones (chirps), then hang up. At an external phone, press ✕ 5 1 and wait for the phone to be disconnected (the LCD shows **RECEIVING**) before you hang up. (Your caller will have to press **Black Fax Start** to send the fax.)

Changing the Fax Receive Code

The preset Fax Receive Code (✕ 5 1) might not work with some telephone systems.



If you are always disconnected when accessing your external TAD remotely, try changing the Fax Receive Code from ✕ 5 1 to # # #.

- 1 Press **Menu/Set**, **2**, **1**, **3**.

3.REMOTE CODE

- 2 Press  to select **ON** (or **OFF**),
and then press **Menu/Set**.

REMOTE ACT.:ON?

- 3 If you want to, enter a new Fax Receive Code, and then press **Menu/Set**.

FAX RECEIVE:*51

- 4 Press **Stop/Exit**.

Printing a Fax in Memory

If you set Fax Storage to **ON** for remote retrieval, you can still print a fax from the memory when you are at your MFC. (See *Setting Fax Storage*, page 8-2.)

- 1 Press **Menu/Set**, **2**, **5**, **4**.

4.PRINT FAX

- 2 Press **Black Fax Start**.

- 3 After printing is finished, press **Stop/Exit**.

Polling

Polling is the process of retrieving faxes from another fax machine. You can use your MFC to “poll” other machines, or you can have someone poll your MFC.

All parties involved in polling need to set up their fax machines to accommodate polling. When someone polls your MFC to receive a fax, they pay for the call; if you poll someone’s fax machine to receive a fax, you pay for the call.



Some fax machines do not respond to the polling function.

Setting Up Polling Receive

Polling Receive is when you call another fax machine to receive a fax from it.

- 1 Press **Menu/Set**, **2**, **1**, **5**.

5.POLLING RX

- 2 Press  to select **POLLING RX: ON**,
(or **POLLING RX: OFF**), and then press **Menu/Set**.

- 3 Enter the fax number you are polling.

- 4 Press **Black Fax Start**.
The LCD shows **DIALING**.

Setting Up Sequential Polling Receive

Your MFC can request documents from several fax units in a single operation. Afterward, a Sequential Polling Report will be printed.

- 1 Press **Menu/Set**, **2**, **1**, **5**.

5.POLLING RX



- 2 Press  to select **POLLING RX: ON**,
and then press **Menu/Set**.

- 3 Specify the destination fax machines you wish to poll using, Speed Dial, a Group or the dial pad. You must press **Menu/Set** between each location.

- 4 Press **Black Fax Start**.
Your MFC will poll each number or group number in turn for a document.

Canceling a Scheduled Job

You can cancel tasks you've scheduled, such as Delayed Fax or Polling Transmit. (See *Canceling a Job in Memory*, page 6-7.)

- 1 Press **Menu/Set, 2, 6**. Any waiting jobs appear on the LCD. If no job is waiting, the LCD shows **NO JOB WAITING**.

- 2 If you have more than two jobs waiting, press  **OR**  to select the job you want to cancel, and then press **Menu/Set**.
—**OR**—
If you have only one job waiting, go to Step 3.
- 3 Press **1** to cancel—**OR**—Press **2** to exit without canceling.
To cancel another job, return to Step 2.
- 4 Press **Stop/Exit**.

Telephone Services

Your MFC supports the Distinctive Ring telephone service offered by some telephone companies.



If you have Voice Mail, Call Waiting, Caller ID, Call Waiting/Caller ID, RingMaster, an answering service, or an alarm system custom feature on your telephone line, it may create a problem in the operation of your MFC. (See *Custom Features on a Single Line*, page 19-8.)

If you have Voice Mail on your phone line, please read the following carefully.

Distinctive Ring

The term “Distinctive Ring” is used by Brother to identify a phone company service that is given *many names, depending on the Telephone Company you are using*. For example, this service may be called SmartRing, RingMaster, Teen-Ring, Indent-a-Call or Indent-a-Ring.

What Does Your Telephone Company’s “Distinctive Ring” Do?

Your telephone company’s Distinctive Ring service allows more than one number on same phone line. **If you need more than one phone number, it is an inexpensive alternative to paying for an additional line.** Each phone number has its own distinctive ring pattern, so you will know which phone number is ringing. This is one way you can have a separate phone number for your MFC.



Please consult your telephone company for availability and rates.

What Does Brother’s “Distinctive Ring” Do?

The Brother machine has a Distinctive Ring feature that allows you to use your MFC machine to take full advantage of the telephone company’s Distinctive Ring service. You can dedicate the new phone number on your line to receiving only faxes.



You must purchase your telephone company’s Distinctive Ring service *before* you program the MFC to work with it.

Do You Have Voice Mail?

If you have Voice Mail on the phone line on which you will install your new MFC, *there is a strong possibility that Voice Mail and the MFC will conflict with each other while receiving incoming calls.* **However, this Distinctive Ring feature allows the use of more than one number on your line, so both Voice Mail and the MFC can coexist peacefully.** If each one has a separate phone number, neither will interfere with the other's work.





If you decide to get the Distinctive Ring Service from the telephone company, you will need to follow the directions below to "register" the new Distinctive Ring pattern they provided, so your fax machine can recognize its incoming calls.



You can change or cancel the Distinctive Ring pattern at any time. You can switch it off temporarily, and later turn it back on. When you get a new fax number, make sure you reset this feature.

Before You Choose the Ring Pattern to Register

You can register only one Distinctive Ring pattern with the MFC. Some ring patterns cannot be registered. Please refer to some popular ring pattern examples that will be provided from the phone company in the USA and Canada that are shown in the Brother compatibility table below.

Ring Pattern	Rings	
1	long - long	
2	short - long - short	
3	short - short - long	
4	very long (normal pattern)	





If the ring pattern the phone company provided cannot be registered by the fax, **please check for other available ring pattern choices from the phone company.**

- The MFC will answer only calls to its registered number.
- The first two rings are silent on the fax machine. This is because the fax must «listen» to the ring pattern (compare it to the pattern that was "registered").
- If you program the MFC correctly, it will recognize the registered ring pattern of the "fax number" within 2 ring patterns and then automatically answer with a fax tone. When the "voice number" is called, the fax machine will not interrupt the call.

Very Important

If you have Voice Mail or a TAD (Telephone Answering Device) and want to keep one of your phone numbers dedicated only to fax calls, you must leave the MFC in **MANUAL** mode at all times while using the Distinctive Ring Feature. Here's why: **MANUAL** mode will never pick up a call by itself, since it is «Neutral». When the MFC is in this «neutral» mode, the Distinctive Ring Feature can be activated. The Distinctive Ring feature is actually an answering mode. So, do not activate **FAX ONLY** mode while using Distinctive Ring; otherwise, the fax machine will answer calls for *all* the numbers.

Registering the Distinctive Ring Pattern

- 1 Set the MFC to **MANUAL** mode.
- 2 Press **Menu/Set, 2, 0, 1**.
- 3 Press  to select **DISTINCTIVE:SET?**, and then press **Menu/Set**.
- 4 Press  to select the prestored ring pattern you want to assign, and then press **Menu/Set**. (You will hear each pattern as you scroll through the four patterns.) Be sure to choose the pattern assigned by the telephone company.
- 5 Press **Stop/Exit**.

6 Setup Send

Before You Begin

You can send a fax from the ADF (Automatic Document Feeder) or from the scanner glass.

Sending Faxes Using Multiple Settings

When you send a fax you can choose any combination of these settings: set the contrast or resolution; send using overseas mode, delayed fax timer, polling transmission or real time transmission. After each menu selection is accepted, the LCD will ask if you want to enter other settings:

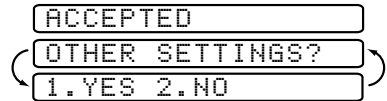

Press **1** if you want to select additional settings. The LCD returns to the SETUP SEND menu—**OR**—Press **2** if you are finished choosing settings, and then go to the next step.

Faxing from the ADF (Automatic Document Feeder)

The ADF can hold up to 30 pages, feeding each one individually through the MFC. Use standard (20 lb/75g/m²) paper when using the ADF and always fan the pages well first.

Recommended Environment

Temperature: 68°F – 86°F (20°C – 30°C)

Humidity: 50% – 70%

Paper: Xerox 4200 (20LB/LTR)



⊘ DO NOT use curled, wrinkled, folded, ripped paper, or paper with staples, paper clips, paste or tape attached. **DO NOT** use cardboard, newspaper or fabric. (To fax this kind of original, see *Faxing from the Scanner Glass*, page 6-3.)

- Make sure documents written with ink are completely dry.
- Originals to be faxed must be from 5.8 to 8.5 inches wide and 5.8 to 14 inches long.

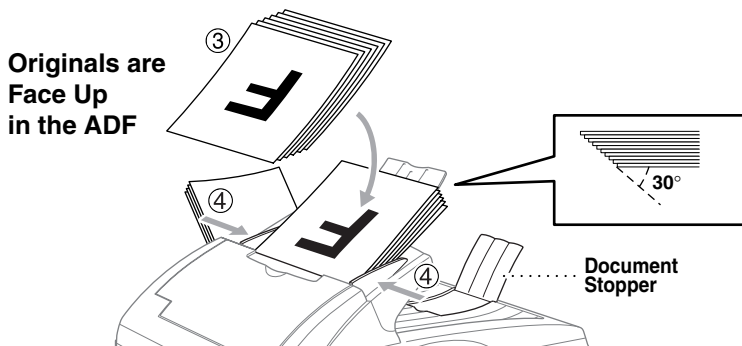
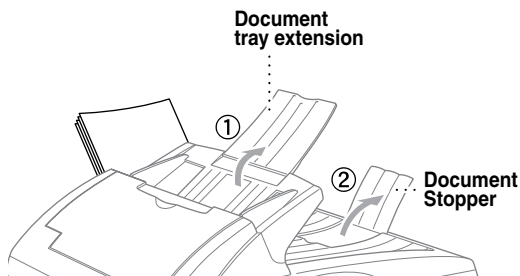
- 1 Unfold the document tray extension.
- 2 Unfold the document stopper.
- 3 Fan the pages and stagger them at a 30 degree angle. Insert the pages *face up, top edge first* in the ADF until you feel them touch the feed roller.
- 4 Adjust the paper guides to fit the width of your original.



Setting the Special Media Lever

You can use the special media lever to select the Regular position () or Special position. ()

To feed special types of originals (such as thin paper, thick paper, coated paper or glossy paper), move the special media lever to the Special position (). It will allow the original to feed through the ADF without slipping or jamming.

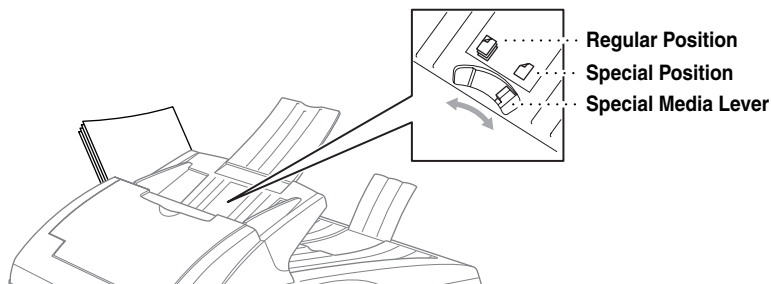

If the original “double-feeds,” try again by inserting a single sheet of original in the ADF or use Scanner glass.

Faxing from the Scanner Glass

You can use the scanner glass to fax one page at a time or pages of a book. Originals can be letter or A4 size (8.5 inches to 11.7 inches).

To use the scanner glass, the ADF must be empty.

- 1 Lift the document cover.
- 2 Using the document guidelines on the left, center the original *face down* on the scanner glass.
- 3 Close the document cover.

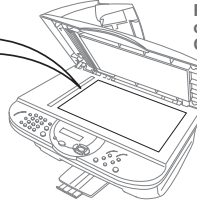

Originals are
Face Down
on the Scanner
Glass

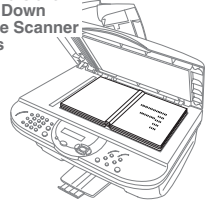

If the original is a book or is thick, do not slam the cover or press on it.

- 4 Dial the fax number, and then press **Black Fax Start**. The MFC starts scanning the first page.
- 5 To send a single page, go to Step 7
—OR—
To send multiple pages, go to Step 6.
- 6 Place the next page on the scanner glass, and then press **Menu/Set**. The MFC starts scanning. (Repeat this step for each additional page.)
- 7 Press **Black Fax Start** to begin dialing.



Press **Stop/Exit** to cancel.



If memory is full and you are faxing a single page, it will be sent in real time.





You can fax a single color page from the scanner glass.

Basic Sending Operations

Contrast

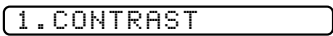
If your document is very light or very dark, you might want to set the contrast. Use **S.LIGHT** to send a very light document. Use **S.DARK** to send a very dark document.



- 1 Place the original face up in the ADF, or face down on the scanner glass. 
- 2 Press **Menu/Set, 2, 2, 1**.
- 3 Press  to select **AUTO, S.LIGHT** or **S.DARK**, and then press **Menu/Set**.
- 4 Press **1** if you want to select additional settings. The LCD returns to the **SETUP SEND** menu—**OR**—Press **2** if you are finished choosing settings, and then go to Step 5.
- 5 Enter a fax number.
- 6 Press **Black Fax Start** to send a fax.

Fax Resolution

When you have a document in the ADF, or on the scanner glass you can use the **Fax Resolution** key to change the setting temporarily (for this fax only) Press **Fax Resolution** repeatedly until the LCD shows the setting you want.

—OR—

You can change the default setting.

- 1 Press **Menu/Set, 2, 2, 2**. 
- 2 Press  to select the resolution you want, and then press **Menu/Set**.
- 3 Press **Stop/Exit**.

STANDARD—Suitable for most typed documents.

FINE—Good for small print; transmits a little slower than Standard resolution.

S. FINE—Good for small print or artwork; transmits slower than Fine resolution (black and white only).

PHOTO—Use when original has varying shades of gray; this is the slowest transmission time (black and white only).

Manual Transmission (With an External Telephone)

Manual transmission lets you hear the dial tone, ringing and fax receiving tones while sending the fax.

- 1 Place the original face up in the ADF, or face down on the scanner glass.
- 2 Pick up the handset of the external phone and listen for a dial tone.
- 3 Dial the fax number you want to call on the external phone.
- 4 When you hear the fax tone, press **Black Fax Start**.
- 5 Replace the handset of the external phone.

Automatic Transmission

This is the easiest way to send a fax.

- 1 Place the original face up in the ADF, or face down on the scanner glass.
- 2 Enter the fax number using the dial pad, Speed Dial or Search.
(See *Speed Dialing*, page 7-4.)
- 3 Press **Black Fax Start**.

Color Fax Transmission

Your MFC allows you to transmit a color fax.

- 1 Place the original face up in the ADF, or face down on the scanner glass.
- 2 Enter the fax number using the dial pad, Speed Dial or Search.
- 3 Press **Color Fax Start**.



When you send a color fax, the MFC sends the fax without scanning the original into memory.

Manual and Automatic Fax Redial

If you're sending a fax manually and the line is busy, press **Redial/Pause** to try again. Anytime you want to make a second call to the last number dialed, press **Redial/Pause** to save time.

If you're sending a fax automatically and the line is busy, the MFC will automatically redial (up to three times at five minute intervals).

Dual Access (Not Available for Color Fax)

You can place an original in the ADF and set temporary settings, dial a number, and begin scanning the fax into memory—even when the MFC is receiving a fax, sending a fax, or printing a fax from memory. The LCD shows the new job number and available memory.



If you get a **OUT OF MEMORY** message while scanning the first page of a fax, press **Stop/Exit** to cancel scanning. If you get a **OUT OF MEMORY** message while scanning a subsequent page, you can press **Black Fax Start** to transmit the pages scanned so far, or press **Stop/Exit** to cancel the operation.

- 1 Place the original face up in the ADF, or face down on the scanner glass.
- 2 Enter the fax number.
- 3 Press **Black Fax Start**. The MFC scans the original and the LCD shows the job number (#XXX) of the fax and how much memory is available. Then the MFC starts dialing. You can immediately repeat Steps 1 to 3 for the next fax.



Your machine normally operates in Dual Access mode. However, to send a color fax, you must override Dual Access and use Real Time Transmission.



The number of pages you can scan into memory varies with the data they contain.

Real Time Transmission

When you are sending a fax, the MFC will scan originals into memory before sending. Then, as soon as the phone line is free, the MFC will start dialing and sending the fax. If memory becomes full, the MFC will send the document in real time (even if **REAL TIME TX** is set to **OFF**).

Sometimes you may want to send an important document immediately, without waiting for memory transmission. You can set **REAL TIME TX** to **ON**.

- 1 Place the original face up in the ADF, or face down on the scanner glass.
- 2 Press **Menu/Set, 2, 2, 5**.



- 3 To change the default setting, press  to select **ON** (or **OFF**), and then press **Menu/Set**.

Go to Step 5—**OR**—For the next fax transmission only, press  to select **NEXT FAX ONLY**, and then press **Menu/Set**.

- 4 For the next fax only, press  to select **ON** (or **OFF**), and then press **Menu/Set**.
- 5 Press **1** if you want to select additional settings. The LCD returns to the **SETUP SEND** menu—**OR**—Press **2** if you are finished choosing settings, and then go to Step 6.
- 6 Enter fax number, and then press **Black Fax Start**.



If you are sending a color Fax, the MFC will send it in real time even if **REAL TIME TX** is set to **OFF**.



Checking Job Status

Check which jobs are still waiting in memory to be sent. (If no jobs are waiting, the LCD shows **NO JOB WAITING.**)
(See *Canceling a Job in Memory* below.)

- 1 Press **Menu/Set, 2, 6.**
- 2 If you have multiple jobs waiting, press  to scroll through the list.
- 3 Press **Stop/Exit.**

Canceling a Job in Memory



You can cancel tasks you've scheduled, such as Polling Transmit, or faxes waiting in Memory to be sent. (See *Checking Job Status* above.)

- 1 Press **Menu/Set, 2, 6.**
Any waiting jobs appear on the LCD. 
If no jobs are waiting, the LCD shows **NO JOB WAITING.**
- 2 If you have more than two jobs waiting, press  to select the job you want to cancel, and then press **Menu/Set.**
—OR—
If you have only one job waiting, go to Step 3.
- 3 Press **1** to cancel—OR—Press **2** to exit without canceling.
To cancel another job, return to Step 2.
- 4 Press **Stop/Exit.**

Advanced Sending Operations

Overseas Mode

After you send a fax using this feature, the feature turns itself off.

- 1 Place the original face up in the ADF, or face down on the scanner glass.
- 2 Press **Menu/Set, 2, 2, 7.** 
- 3 Press  to select **ON** (or **OFF**),
and then press **Menu/Set.**
- 4 Press **1** if you want to select additional settings. The LCD returns to the **SETUP SEND** menu—OR—Press **2** if you are finished choosing settings, and then go to Step 5.
- 5 Enter the fax number you're calling.
- 6 Press **Black Fax Start.**

Delayed FAX (Not Available for Color Fax)

During the day you can store *up to* 50 documents in memory for delayed sending. Transmission of these documents will begin at the time of day you enter in Step 3, which shows the time you entered last. Press **Menu/Set** to accept it, or enter another time for this fax.



- 1 Place the original face up in the ADF, or face down on the scanner glass.
- 2 Press **Menu/Set, 2, 2, 3.** 
- 3 Enter the time you want the fax to be sent (in 24-hour format), and then press **Menu/Set**. (For example, enter 19:45 for 7:45 PM.)
- 4 Press **1** if you want to select additional settings. The LCD returns to the **SETUP SEND** menu—**OR**—Press **2** if you are finished choosing settings, and then go to Step 5.
- 5 Enter the fax number.
- 6 Press **Black Fax Start**. The MFC will wait to send the fax at the time you set.



The number of documents you can scan into memory varies with the data they contain.

Delayed Batch Transmission (Not Available for Color Fax)

Before sending the delayed faxes, your Brother machine will economize by sorting all the documents in memory by destination and scheduled time. All delayed faxes scheduled at the same time to the same fax number will be sent as one transmission.

- 1 Press **Menu/Set, 2, 2, 4.** 
- 2 Press  to select **ON** (or **OFF**), and then press **Menu/Set**.
- 3 Press **Stop/Exit**.

Setting Up Polled Transmit (Not Available for Color Fax)

Polled Transmit is when you set up your MFC to wait with a document so another fax machine can retrieve it.

1 Place the original to be retrieved face up in the ADF, or face down on the scanner glass.

2 Press **Menu/Set, 2, 2, 6.**

6. POLLED TX

3 Press  to choose

POLLED TX: ON?
(or **POLLED TX: OFF**),
and then press **Menu/Set**.

4 Press **1** if you want to select additional settings. The LCD returns to the **SETUP SEND** menu—**OR**—Press **2** if you are finished choosing settings, and then go to step 5.

5 Press **Black Fax Start**.

7 Auto Dial Numbers and Dialing Options

Storing Numbers for Easy Dialing

You can set up your MFC to do two types of easy dialing: Speed Dial and Groups for Broadcasting faxes.



If you loose electrical power, auto dial numbers in memory will NOT be lost.

Storing Speed Dial Numbers

You can store Speed Dial numbers, so when you dial you will have to press only five keys (Search/Speed Dial, #, the two-digit location, and Black Fax Start). The MFC has 40 Speed Dial locations.





(For USA Only) Speed Dial location 01 has been pre-programmed for the Brother fax-back system. You can override it if you wish.

- 1 Press **Menu/Set**, **2**, **3**, **1**.
- 2 Use the dial pad to enter a two-digit location (01-40), and then press **Menu/Set**.
- 3 Enter the number (up to 20 digits), and then press **Menu/Set**.
- 4 Use the dial pad to enter the name (up to 15 characters), and then press **Menu/Set**. You can use the chart on page 4-3 to help you enter letters—**OR**—Press **Menu/Set**, and then go to Step 5 to store the number without a name.
- 5 Return to Step 2 to store another Speed Dial number—**OR**—Press **Stop/Exit**.

Changing Speed Dial Numbers

If you try to store a Speed Dial number in a location where a number is already stored, the LCD shows the current name stored there and prompts you to either:

1.CHANGE 2.EXIT

- 1 Press **1** to change the stored number—**OR**— Press **2** to exit without making a change.
- 2 Enter a new number, and then press **Menu/Set**.
 - If you want to erase the whole number, press **Stop/Exit** when the cursor is to the left of the digits. The letters above and to the right of the cursor will be deleted.
 - If you want to change a digit, use  or  to position the cursor under the digit you want to change, and then type over it.
- 3 Follow the directions beginning at Step 4 in *Storing Speed Dial Numbers*.

Setting Up Groups for Broadcasting

Groups allow you to send the same fax message to many fax numbers by pressing only five keys (**Search/Speed Dial**, **#**, the two-digit location, and **Black Fax Start**). **First**, you'll need to store each fax number as a Speed Dial number. **Then**, you can combine them into a Group. Each Group uses up a Speed Dial number. You can have up to six Groups, or you can assign up to 39 numbers to one large Group.

(See *Storing Speed Dial Numbers*, page 7-1 and *Broadcasting*, page 7-5.)

- 1 Press **Menu/Set**, **2**, **3**, **2**.

2.SETUP GROUPS

PRESS SPEED DIAL

SPEED-DIAL? #

- 2 Press **Search/Speed Dial**, enter the two-digit location where you wish to store the Group number, and then press **Menu/Set**.

(For example, press **Search/Speed Dial**, **07**.)

SETUP GROUP:G0

- 3 Use the dial pad to enter the Group number, and then press **Menu/Set**. (For example, press **1** for Group 1.)

- 4 To include Speed Dial numbers in the Group, enter them as if you were dialing.

For example, for Speed Dial locations 05 and 09, press the **Search/Speed Dial** press **05**, **Search/Speed Dial**, and then **09**. The LCD shows: **#05#09**.

G01:

ENTER & SET KEY

G01:#05#09_

- 5 Press **Menu/Set** to accept the numbers for this Group.

- 6 Use the dial pad and the chart on page 4-3 to enter a name for the Group, and then press **Menu/Set**. (For example, NEW CLIENTS).

NAME:

- 7 Press **Stop/Exit**.



You can print a list of all Speed Dial numbers. (See Chapter 9, *Printing Reports*.)



Dialing Options



When you dial using an auto dial number, the LCD shows the name you've stored, or if you haven't stored a name, the fax number you've stored.

Search

You can search for names you have stored in Speed Dial memory. (See *Storing Speed Dial Numbers*, page 7-1.)

- 1 Place the original face up in the ADF, or face down on the scanner glass.
- 2 Press **Search/Speed Dial**.
- 3 To search for numbers alphabetically by name, enter the first letter of the name, and then press  or  .
—OR—
To search for numbers numerically by Speed-Dial number, press  .
- 4 When the LCD shows the name you want to call, press **Black Fax Start**.

Speed Dialing

- 1 Place the original face up in the ADF, or face down on the scanner glass.
- 2 Press **Search/Speed Dial**, press **#**, then press the two-digit Speed Dial location. (See *Storing Speed Dial Numbers*, page 7-1.)
- 3 Press **Black Fax Start**.

Access Codes and Credit Card Numbers

Sometimes you may want to choose from among several long distance carriers when you make a call. Rates may vary depending upon the time and destination. To take advantage of low rates, you can store the access codes or long-distance carriers as Speed-Dial numbers. You can store these long dialing sequences by dividing them and setting them up on separate keys in any combination. You can even include manual dialing using the dial pad. The combined number will be dialed in the order you entered it, as soon as you press **Black Fax Start**. (See *Storing Speed Dial Numbers*, page 7-1.)

You can store "555" on Speed Dial #03 and "7000" on Speed Dial #02. If you press **Search/Speed Dial, #, 0, 3, Search/Speed Dial, #, 0, 2**, and **Black Fax Start**, you can dial "555-7000". To temporarily change a number, you can substitute part of the number with manual dialing using the dial pad. For example, to change the number to 555-7001 you could press **Search/Speed Dial, #, 03** and then press **7, 0, 0, 1** using the dialing pad.



If you must wait for another dial tone at any point in the dialing sequence, store a pause at that point in the number by pressing **Redial/Pause**. Each key press adds a 3.5 second delay.

Broadcasting (Not Available for Color Fax)

Broadcasting is automatically sending the same fax message to multiple fax numbers. Using the **Menu/Set** key, you can include Groups, Speed Dial locations plus up to 50 manually dialed numbers. If you did not use up any locations for Groups, access codes or credit card numbers, you can "broadcast" faxes automatically to up to 90 different locations from the MFC. However, available memory will vary with all types of jobs in memory and numbers of locations used for broadcasting. If you broadcast to more than the maximum locations available, you will not be able to set up transmissions using Dual Access and the Timer.

Although the easiest way to broadcast is to press Group keys, you can include Speed Dial and manually dialed numbers in the same broadcast. You must press **Menu/Set** between each of these locations. Use **Search/Speed Dial** to help you choose the numbers easily.

(See *Setting Up Groups for Broadcasting*, page 7-3.)

After the broadcast is finished, a Broadcast Report will be printed automatically to let you know the results.

- To stop the broadcast in progress, press **Stop/Exit**. The LCD asks if you want to cancel the location that is being sent.
- Enter the long dialing sequence numbers as you normally would, but keep in mind that each key counts as one location, so the number of locations you can call becomes limited.
- If the line is busy or for other reasons a connection could not be made while broadcasting, the MFC will redial the number automatically.
- If the memory is full, press **Stop/Exit** to abort the job or if more than one page has been scanned, press **Black Fax Start** to send the portion that is in the memory.

- 1 Place the original face up in the ADF, or face down on the scanner glass.
- 2 Enter a number using Speed Dial, a Group number, Search or the dial pad.
Example: Group number
- 3 Press **Menu/Set**. You will be prompted to press the next number.
- 4 Enter the next number.
Example: Speed Dial
- 5 Press **Menu/Set**.
- 6 Enter the fax number.
Example: Manual dialing using the dial pad.
- 7 Press **Black Fax Start**.
Your MFC will read the original into memory and then start sending faxes to the numbers you entered.

Pause

Press **Redial/Pause** to insert a 3.5 second pause between numbers. If you are dialing overseas, you can press **Redial/Pause** as many times as needed to increase the length of the pause.

Fax Redial

If you're sending a fax manually and the line is busy, press **Redial/Pause** to try again. Anytime you want to make a second call to the last number dialed, press **Redial/Pause** to save time.

If you're sending a fax automatically and the line is busy, the MFC will redial automatically up to three times at five minute intervals.

Tone/Pulse (For Canada Only)

If you have Pulse dialing service, but need to send tone signals (for example, for telephone banking), follow the directions below. If you have Touch Tone service, you will not need this feature to send tone signals.

- 1 Lift the handset of an external phone.
- 2 Press #. Any digits dialed after this send tone signals.
- 3 When you hang up, the MFC returns to pulse dialing service.

8

Remote Fax Options

(Not Available for Color Fax)

Fax Forwarding/Paging



*You cannot use Paging and Fax Forwarding at the same time.
You cannot use Paging and Fax Forwarding when Fax Storage is set to OFF.*

Programming a Fax Forwarding Number

When Fax Forwarding is set to **ON**, your MFC stores the received fax in memory. Then it dials the fax number you've programmed and forwards the fax message.

- 1 Press **Menu/Set**, **2**, **5**, **1**.

1.FAX FWD/PAGING

- 2 Press  until the LCD shows **FAX FORWARD?**, and then press **Menu/Set**.

- 3 The LCD prompts you to enter the fax number where faxes will be forwarded. Enter the forwarding number (up to 20 digits), and then press **Menu/Set**.

FWD#:

- 4 Press **Stop/Exit**.

Programming Your Pager Number

When Paging is selected, your MFC dials the pager number you've programmed, and then dials your Personal Identification Number (PIN); this activates your pager so you will know that you have a fax message in the memory.

- 1 Press **Menu/Set**, **2**, **5**, **1**.

1.FAX FWD/PAGING

- 2 Press  until the LCD shows **PAGING?**, and then press **Menu/Set**.

- 3 Enter your pager phone number (up to 20 digits) followed by **# #**, and then press **Menu/Set**. Do not include the area code if it is the same as that of your MFC.

PAG#:

For example, 1 8 0 0 5 5 5 1 2 3 4 # #.

- 4 If your pager requires a PIN, enter the PIN, press **#**, press **Redial/Pause**, enter your MFC telephone number followed by **# #**, and then press **Menu/Set**.
For example, **1 2 3 4 5 # Redial/Pause 1 8 0 0 5 2 1 2 8 4 6 # #**
—OR—

If you do not need a PIN, press **Redial/Pause**, enter the fax number of your MFC followed by **# #**, and then press **Menu/Set**.

For example, **Redial/Pause 1 8 0 0 5 2 1 2 8 4 6 # #**

- 5 Press **Stop/Exit**.



You cannot change a Paging number or PIN remotely.

Setting Fax Storage

If you set Fax Storage to **ON**, you will be able to retrieve fax messages from another location using Fax Forwarding, Paging, or Remote Retrieval functions. The LCD will indicate when you have a fax stored in memory.

- 1 Press **Menu/Set, 2, 5, 2**. The LCD prompts you to choose a fax setting.

- 2 Press  to select **ON** (or **OFF**), and then press **Menu/Set**.

- 3 Press **Stop/Exit**.



If there are faxes in memory when you turn the Fax Storage **OFF**, the LCD prompts you to erase any faxes in memory.

If you press **1**, all fax data is erased and Fax Storage is turned off. If you press **2**, data is not erased and Fax Storage remains on.

(See *Printing a Fax in Memory*, page 5-4.)

Backup Print

If you've set **FAX STORAGE** to **ON**, your MFC *automatically* prints faxes as they are received into memory. This is a safety feature in case the power goes out so you won't lose your messages.

Changing Remote Retrieval Access Code

Enter your Remote Access Code when the MFC picks up your call, so you can access features remotely. The access code is preset to 1 5 9 ✖, but you can change this. (See *Operation from Extension Telephone*, page 5-4.)

- 1 Press **Menu/Set, 2, 5, 3**.

3.REMOTE ACCESS

- 2 Enter a three-digit number from 000 to 999, and then press **Menu/Set**. The “✖” cannot be changed. (Do not use the same digits that appear in your Fax Receive Code or Telephone Answer Code.)
- 3 Press **Stop/Exit**.

Remote Retrieval

You can call your MFC from any fax machine using touch tone, then use the Remote Retrieval Access Code and other button presses to retrieve fax messages. *Cut out the Remote Retrieval Access Card on the last page and keep it in your wallet as an aid.*

Using Remote Retrieval Access Code

- 1 Dial your fax number from a fax machine using touch tone.
- 2 When your MFC answers, immediately enter your Remote Retrieval Access Code (1 5 9 ✖).
- 3 The MFC signals the kinds of messages received:
1 long beep — Fax message(s)
No long beeps — No messages
- 4 The MFC prompts you with two short beeps to enter a command. If you wait longer than 30 seconds to enter a command, the MFC hangs up. If you enter an invalid command, the MFC beeps three times.
- 5 Press **9 0** to reset the MFC when you're finished.
- 6 Hang up.



If your MFC is set to **MANUAL** mode, you can access it by waiting about 2 minutes, and then entering the Remote Retrieval Access Code within 30 seconds.

Remote Commands

Follow the commands below to access features remotely. When you call the MFC and enter your Remote Retrieval Access Code (1 5 9 ✖), the system will signal you with two short beeps to enter a remote command.

Remote Commands	Operation Details
95 Change Fax Forwarding /Paging setting	
1 OFF	If you hear one long beep, the change is accepted. If you hear three short beeps, you cannot change it because the conditions have not been met (Example: registering paging number). You can register your fax forwarding number by using 4. FAX FWD NO. (see page 8-5). Once you have registered the number, the MFC will change automatically to FAX FWD:ON mode.
2 Fax Forwarding	
3 Paging	
4 FAX FWD No.	
6 Fax Storage ON	You can turn FAX STORAGE to ON or OFF.
7 Fax Storage OFF	
96 Retrieve a fax	
2 Retrieve all faxes	Enter the number of a remote fax machine to receive stored fax message(s). (See page 8-5.)
3 Erase faxes from the memory	If you hear one long beep, you can erase fax messages from the memory.
97 Check the Receiving Status	
1 FAX	You can check whether your MFC has received any faxes. If yes, you will hear one long beep. If no, you will hear three short beeps.
98 Change the Receive Mode	
1 EXT.TEL/TAD	If you hear one long beep, you can change the Receive Mode. If you hear three short beeps, you cannot change it.
2 FAX ONLY	
90 Exit	After a long beep, you can exit Remote Retrieval.

Retrieving Fax Messages

- 1 Dial your fax number.
- 2 When you hear the beep, immediately enter your Remote Retrieval Access Code (**1 5 9 ***).
- 3 As soon as you hear two short beeps, use the dial pad to press **9 6 2**.
- 4 Using the dial pad, enter the number of the remote fax machine where you want your fax messages forwarded (up to 20 digits) followed by **# #**.



You cannot use ***** and **#** as dial numbers. However, if you want to store a pause, press **#**.

- 5 After you hear your MFC beep, hang up and wait. Your MFC calls the remote fax machine. The remote fax machine prints your fax messages.

Changing Fax Forwarding Number

You can change the default setting of your fax forwarding number from a remote fax machine.

- 1 Dial your fax number.
- 2 When you hear the beep, immediately enter your Remote Retrieval Access Code (**1 5 9 ***).
- 3 When you hear two short beeps, use the dial pad to press **9 5 4**.
- 4 Enter the new number of the remote fax machine where you want your fax messages forwarded (up to 20 digits) followed by **# #**.



You cannot use ***** and **#** as dial numbers. However, if you want to store a pause, press **#**.

- 5 After you hear your MFC beep, hang up.

9 Printing Reports

MFC Settings and Activity

Two reports require initial setup in the Menu table: Transmission Verification Report and Activity Report Interval. For initial setup:

Press **Menu/Set, 2, 4, 1.**

1. TRANSMISSION

—OR—

Press **Menu/Set, 2, 4, 2.**

2. ACT. INTERVAL

Customizing the Transmission Verification Report

You can use the Transmission Report as proof that you sent a fax. This report lists the time and date of transmission and whether the transmission was successful (OK). If you select **ON** or **ON+IMAGE**, the report will print for every fax you send.



When the feature is **OFF**, the report prints only if a transmission error prevented delivery (NG).

If you typically send multiple faxes to the same destinations, you may need more than the job numbers to know which faxes you must send again. Selecting **OFF+IMAGE** will print a portion of the fax's first page on the report to help you remember.

1 Press **Menu/Set, 2, 4, 1.**

1. TRANSMISSION

2 Press  to select **OFF**,

OFF+IMAGE, ON or **ON+IMAGE**,
and then press **Menu/Set**.

3 Press **Stop/Exit**.

Setting the Fax Activity Report Interval

You can set the machine to print activity reports at specific intervals (6, 12, 24 hours, 2, 4, or 7 days). If you set the interval to **OFF**, you can print the report by following the Steps in the previous section.

1 Press **Menu/Set, 2, 4, 2.**

2. ACT. INTERVAL

- 2 Press  to choose an interval, and then press **Menu/Set**.

INTERVAL: OFF

(If you choose 7 days, the LCD prompts you to choose a day at which to begin the 7-day countdown.)

- 3 Enter the time to begin printing in 24-hour format, and then press **Menu/Set**.
(For example: enter 19:45 for 7:45 PM.)
- 4 Press **Stop/Exit**.

Using the Reports Key



Five reports are available:

1.HELP LIST

Prints the Help List so you can see at-a-glance how to quickly program every menu selection and key operations.

2.AUTO DIAL

Lists names and numbers stored in Speed Dial memory, in numerical order.

3.FAX ACTIVITY

Lists information about the last 200 incoming and outgoing faxes. TX means Transmit; RX means Receive.

4.TRANSMISSION

Prints a Transmission Verification Report for your last transmission.

5.USER SETTINGS

Lists settings for **GENERAL SETUP**, **SETUP RECEIVE**, **SETUP SEND**, **SETUP REPORTS**, and **TEL SERVICE**. The settings for **REMOTE FAX OPT** are included.

To Print a Report

- 1 Press **Reports**.
- 2 Press  to select the report you want, and then press **Menu/Set**.

—OR—

Enter the number of the report you want to print. For example, press **1** to print the Help List.

10 Making Copies

Basic Copy Operations

Your MFC allows you to make high-quality photocopies and transparencies. Copies can be in black and white, or full color. Always make sure you have paper in the cassette before making copies. Do not pull on the paper while copying is in progress.

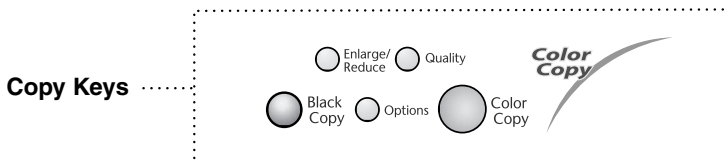

 Incoming faxes cannot be received on paper or into memory while the MFC is copying.

 If the original is a post card, place it on the scanner glass. Post cards can NOT be fed through the ADF.

Making a Single Copy

- 1 Place the original face up in the ADF, or face down on the scanner glass.
- 2 As needed, use **Options** and **Reduce/Enlarge** to change the settings.
- 3 Press **Black Copy** or **Color Copy**.

 To stop the copy process and release the original, press **Stop/Exit**.

Making Multiple Copies (Using the ADF)

You can make multiple copies using the ADF. Multiple copies will be stacked or sort. Use the **Options** key to select **SORT** (See *Using the Options Key*, page 10-5.)

- 1 Place the original face up in the ADF.
- 2 Using the dial pad, enter the number of copies you want (up to 99).
For example, press 3 8 for 38 copies.

 To sort the copies, use the **Options** key. (See *Using the Options Key*, page 10-5.)

- 3 Press **Black Copy** or **Color Copy**.

 Sorting color copies uses more memory and depends upon the data.

 If you selected **GLOSSY** in the Paper Type Setting, Multiple Copies (Using the ADF) are not available.

Out of Memory Message

If the memory becomes full while you are making copies, the screen shows a message:



OUT OF MEMORY

If the **OUT OF MEMORY** message appears while you are scanning the first page of your original, press **Stop/Exit** to cancel. You will need to clear some jobs from memory before you can continue. If you were scanning subsequent page(s), press **Black Copy** or **Color Copy** to print the scanned pages or press **Stop/Exit** to cancel.



To gain extra memory, you can turn off Fax Storage (see page 8-2).
—OR—Print the faxes in memory (see page 5-4).

Single or Multiple Copies (Using the Scanner Glass)

You can make multiple copies using the Scanner Glass. Multiple copies will be stacked (all copies of page 1, then all copies of page etc.). Use the **Options** key to choose additional settings. For details about using the **Options** key, please see *Using the Options Key*, page 10-5.

- 1 Lift the Document Cover.

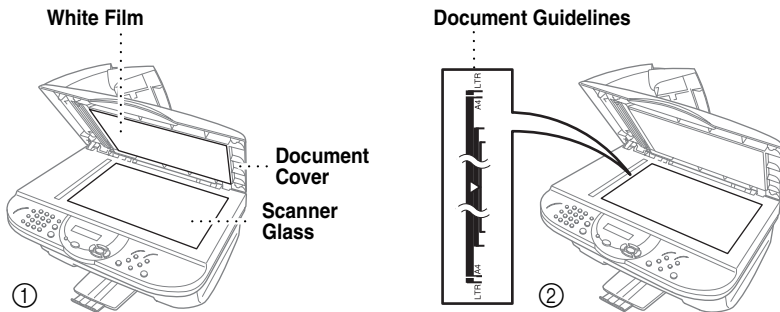

- 2 Using the document guidelines on the left, center the original face down on the scanner glass and close the document cover.
- 3 Using the dial pad, enter the number of copies you want (up to 99), and then press **Black Copy** or **Color Copy**. *For example*, press **3 8** for 38 copies. The MFC starts scanning the original.



If you get an **OUT OF MEMORY** message, you may be able to make multiple copies if you first print incoming faxes in memory and restore the memory to 100%.

- 4 Place the next page to be copied on the scanner glass, and then press **Black Copy** or **Color Copy**.
- 5 Press **Stop/Exit** when you are finished copying.

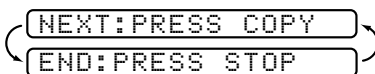

NEXT:PRESS COPY
END:PRESS STOP

Temporary Copy Settings

You can improve your copies by using the Copy keys: **Enlarge/Reduce**, **Quality** and **Options**. These settings are *temporary*, and the MFC returns to its default settings 30 seconds after it finishes copying. If you want to use these temporary settings again, place the next original in the ADF or scanner glass before 30 seconds expire.

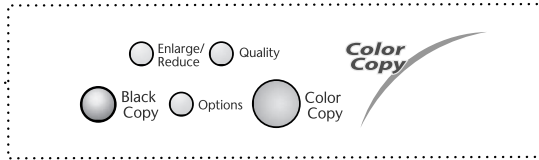

Copy Keys



Copying Using Multiple Settings

You can try different combinations of settings for the best results. After you finish your settings using the **Enlarge/Reduce**, **Quality** and **Options** keys, the LCD shows:





- Press  or  if you want to select additional settings.



—OR—

Press **Black Copy** or **Color Copy** if you are finished choosing settings.

Using the Enlarge/Reduce Key

ZOOM allows you to enter a ratio from 25% to 400% in 1% increments.

Press Enlarge/Reduce and  or 	25%
	50%
	78% LGL>LTR
	94% A4>LTR
	100%
	104% EXE>LTR
	150%
	200%
	400%
	ZOOM

- 1 Place the original face up in the ADF, or face down on the scanner glass.
- 2 Use the dial pad to enter the number of copies you want (up to 99).
- 3 Press **Enlarge/Reduce**. (Enlargement or reduction ratios appear.)
- 4 Press  to select **25%**, **50%**, **78% LGL>LTR**, **94% A4>LTR**, **100%**, **104% EXE>LTR**, **150%**, **200%**, **400%**, and then press **Menu/Set**.
—OR—
You can select **ZOOM** and press **Menu/Set**. Use the dial pad to enter an enlargement or reduction ratio between **25%** and **400%**, and then press **Menu/Set**. For example, press **5 3** to enter **53%**.
- 5 Press **Black Copy** or **Color Copy**—OR—Press  for additional settings.

 Special Copy Options (2 in 1, 4 in 1 or Poster) are *not* available with **Enlarge/Reduce**.

Selecting a Fixed Reduction Ratio

When selecting a reduction ratio, you will need to know the size of the paper you registered in **Menu/Set, 1, 2**.

 **Note** If you want to make a copy the same size as the original, you should choose a reduction of 94%. (For example, if you copy from letter to letter, you should choose a reduction of 94%.)

Original the size of...	Paper size is...	Recommended reduction ratio is...
LETTER DOCUMENT	LETTER	94%
	LEGAL	100%
A4 DOCUMENT	LETTER	94%
LEGAL DOCUMENT	LETTER	78%
	LEGAL	94%

 You can copy on Letter, Legal, A4 and Post Card size paper only.

Using the Quality Key

The **Quality** key temporarily changes the copy quality setting (**NORMAL**, **BEST** or **FAST**).

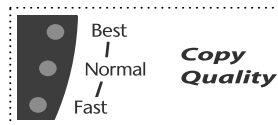

Press **Quality** repeatedly until the LED is lit for the quality you want.

Press Quality and 	FAST:	Fast copy speed and lowest ink consumption. Use FAST to save time (documents to be proof-read, large documents or many copies).
	NORMAL:	Recommended mode for ordinary printouts. Good copy quality with adequate copy speed.
	BEST:	Use this mode to copy precise images such as photographs. BEST uses the highest resolution and slowest speed.

- 1 Place the original face up in the ADF, or face down on the scanner glass.
- 2 Press **Quality**. NORMAL
- 3 Press  to select the copy quality resolution, and then press **Menu/Set**.
- 4 *To start copying now*, press **Black Copy** or **Color Copy**. *If you would like to choose additional copy options*, press **Options** and then select each setting.





Using the Options Key

Use the **Options** key to set number of copies, paper type, paper size, brightness, sort and special copy options **for the next copy only**.

Press Options	Menu Selections	Options	Factory Setting
 Options	OPT:#OF COPIES01	NO. OF COPIES:XX	01
	OPT:PAPER TYPE	PLAIN/INK JET/GLOSSY (4-COLOR or 3-COLOR)/TRANSPARENCY	PLAIN
	OPT:PAPER SIZE	LETTER/LEGAL/A4/ POST CARD: 4" × 6"	LETTER
	OPT:BRIGHTNESS	-■■■■■+	-■■■□□+
	OPT:STACK/SORT	STACK/SORT	STACK
	OPT:SPECIAL	2 IN 1/4 IN 1/POSTER/OFF	OFF



Paper Type

You can change the paper type setting for the next copy only.

- 1 Place the original face up in the ADF, or face down on the scanner glass.
 - 2 Use the dial pad to enter the number of copies you want (up to 99).
 - 3 Press **Options** and press  to select **OPT:PAPER TYPE**, and then press **Menu/Set**.
 - 4 Press  to select the type of paper you are using (**PLAIN, INKJET, GLOSSY** or **TRANSPARENCY**), and then press **Menu/Set**.
 - 5 If you selected **GLOSSY**, press  to select **4-COLOR** or **3-COLOR**, and then press **Menu/Set**.
-  **Note** The print quality of black ink varies depending on the kind of glossy paper you are using. Black ink is used when you select **4-COLOR**. If the glossy paper you are using repels the black ink, select **3-COLOR**, which simulates black ink by combining the three ink colors.
- 6 Press **Black Copy** or **Color Copy**—**OR**—Press  for additional settings.

Paper Size



You can change the paper size setting for the next copy only.

- 1 Place the original face up in the ADF, or face down on the scanner glass.
- 2 Use the dial pad to enter the number of copies you want (up to 99).
- 3 Press **Options** and select **OPT:PAPER SIZE**, and then press **Menu/Set**.
- 4 Press  to select the size of paper you are using (**LETTER, LEGAL, A4** or **POST CARD: 4" × 6"**), and then press **Menu/Set**.
- 5 Press **Black Copy** or **Color Copy**—**OR**—Press  for additional settings.

Copy Brightness



- 1 Place the original face up in the ADF, or face down on the scanner glass.
- 2 Use the dial pad to enter the number of copies you want (up to 99).
- 3 Press **Options** and press  to select **OPT:BRIGHTNESS**, and then press **Menu/Set**.



- 4 Press  to make a lighter copy—**OR**—press  to make a darker copy, and then press **Menu/Set**.
- 5 Press **Black Copy** or **Color Copy**—**OR**—Press  for additional settings.



Sorting Multiple Copies (Using the ADF)

If you want to sort multiple copies, use the ADF.

- 1 Place the original face up in the ADF.
- 2 Use the dial pad to enter the number of copies you want (up to 99).
- 3 Press **Options** and  to select **OPT:STACK/SORT**, and then press **Menu/Set**.
- 4 Press  to select **SORT** (or **STACK**), and then press **Menu/Set**.
- 5 Press **Black Copy** or **Color Copy**—**OR**—Press  for additional settings.



Special Copy Options (Using the ADF)

You can save paper by copying either two or four pages onto one page.

- 1 Place the originals face up in the ADF.
- 2 Use the dial pad to enter the number of copies you want.
- 3 Press **Options** and  to select **OPT:SPECIAL**, and then press **Menu/Set**.
- 4 Press  to select **2 IN 1**, **4 IN 1** (or **OFF**), and then press **Menu/Set**.
- 5 Press **Black Copy** or **Color Copy**—**OR**—Press  for additional settings.

Special Copy Options (Using the Scanner Glass)

You can save paper by copying either two or four pages onto one page, or you can create poster size copy.

- 1 Place the original face down on the scanner glass.
- 2 Use the dial pad to enter the number of copies you want.
- 3 Press **Options** and  to select **OPT:SPECIAL**, and then press **Menu/Set**.
- 4 Press  to select **2 IN 1**, **4 IN 1**, **POSTER** (or **OFF**), and then press **Menu/Set**.



If you selected **2 IN 1** or **4 IN 1** in Step 4, place the next original on the scanner glass, and then press **Menu/Set**. After all originals have been scanned, go to Step 5.



5 Press **Black Copy** or **Color Copy**.

2 in 1



4 in 1

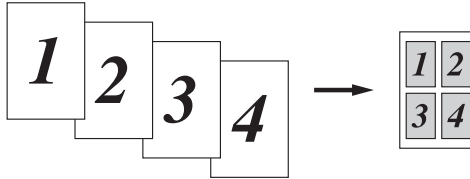

Poster

You can create a poster size copy of a photograph.

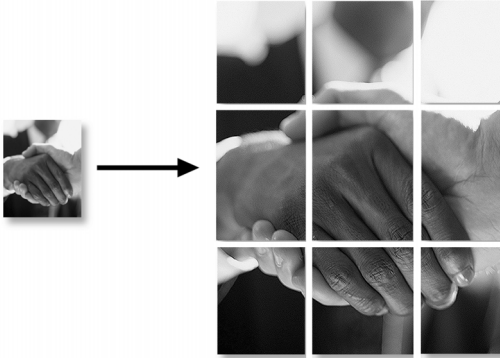

If 2 in 1 or 4 in 1 copies are in color, you must use letter or A4 paper. For the other Special Copies, you must use letter, legal or A4 paper.



Special Copy Options (2 in 1, 4 in 1 or Poster) are not available with **Enlarge/Reduce**.



Poster is not available for multiple copies and requires using the scanner glass.



If you selected **GLOSSY** in the Paper Type setting, 2 in 1 and 4 in 1 copies are not available.



2 in 1 or 4 in 1 copies in color are not available with Multiple Copies.

Changing Default Copy Settings

Press **Menu/Set** and **3** to change default Copy mode settings. They will remain until you change them again by pressing **Menu/Set**.

By pressing a number, you can adjust the Quality, Color and Contrast copy settings as shown in the following chart. Press  to scroll through the options for each setting, and then press **Menu/Set** to save your selection.

Press **Stop/Exit**—OR—Press  to select the next setting you want to change.

Press **Menu/Set** and **3**.

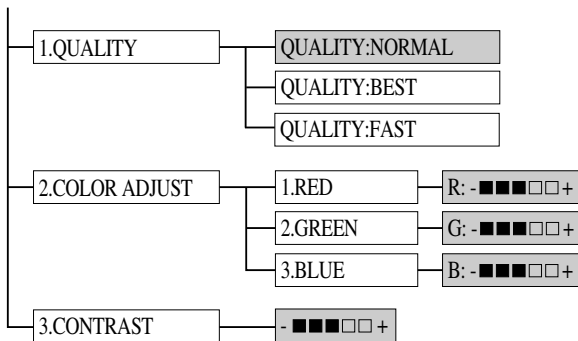

 is default

Copy Quality

1 Press **Menu/Set, 3, 1**.

1. QUALITY

2 Press  to select the copy quality, and press **Menu/Set**.





QUALITY:NORMAL

QUALITY:FAST

QUALITY:FAST

3 Press **Stop/Exit**.

Color Adjustment

- 1 Press **Menu/Set, 3, 2.**
- 2 Press  or  to select **RED, GREEN** or **BLUE**, and then press **Menu/Set.**
- 3 Press  to make a darker copy, or press  to make a lighter copy, and then press **Menu/Set.**
- 4 Return to Step 2 to select the next color
—OR—
Press **Stop/Exit.**

2.COLOR ADJUST



Light Dark
R: - ■■■□□ +

G: - ■■■□□ +

B: - ■■■□□ +

Copy Contrast

You can change the contrast to help an image look sharper and more vivid.

- 1 Press **Menu/Set, 3, 3.**
- 2 Press  to increase the contrast, or press  to decrease the contrast, and then press **Menu/Set.**
- 3 Press **Stop/Exit.**

--- ■■■□□ +

Legal Limitations

Color reproductions of certain documents are illegal and may result in either criminal or civil liability. This memorandum is intended to be a guide rather than a complete listing of every possible prohibition. In case of doubt, we suggest that you check with counsel as to any particular questionable documents.

The following documents issued by the United States/Canadian Government or any of its Agencies may not be copied:

- Paper money
- Bonds or other certificates of indebtedness
- Certificates of Deposit
- Internal Revenue Stamps (canceled or uncanceled)
- Selective Service or draft papers
- Passports
- United States/Canadian Postage Stamps (canceled or uncanceled)
- Food Stamps
- Immigration Papers
- Checks or drafts drawn by Governmental agencies
- Identifying badges or insignias

Copyrighted works cannot be copied; however, sections of a copyrighted work can be copied for “fair use.” Multiple copies would indicate improper use.

Works of art should be considered the equivalent of copyrighted works.

Licenses and Certificates of Title to motor vehicles may not be copied under certain state/provincial laws.

11 Using the MFC as a Printer

Features

The Multi-Function Center offers you many features you'll find in a high quality ink jet printer.

Fast Printing Speed—Using Draft mode, you can print up to 8 pages per minute in full color, and up to 10 pages per minute in black.

Brilliant High Quality Output—Printing at 2400 × 1200 dpi resolution on glossy paper gives you highest resolution output.

Beautiful Elaborate Output—You can utilize 2 in 1, watermark printing, True2Life technology and other features for making beautiful outputs.

Low Running Cost—Whenever you run out of a particular color ink, you'll replace only the cartridge that's empty.

Bi-directional Parallel Interface—The parallel interface allows bi-directional (IEEE 1284 compliant) communication with your computer.

USB—Universal Serial Bus Interface allows for fast communication with your computer.

Straight Paper Path—The MFC can use various types of paper: plain paper, Ink Jet Paper, glossy paper, transparencies, and envelopes. Using the appropriate paper reduces the occurrence of paper jams. For complete information about what kinds of paper to use with the MFC, please read Chapter 2 in this manual.

Printer Driver

You can change the following printer settings when you print from your computer:

- Quality (Speed) /Media
- Color Matching
- Halftone
- Color Enhance/True2Life
- Fast Draft Mode
- Watermark
- Print Date & Time

Choosing the Right Kind of Paper

To achieve high quality printing using your MFC, it's very important to select the right kind of paper. Be sure to read “*Paper*” page 2-3 of Chapter 2 in this manual before selecting and purchasing paper for the MFC.

Multi-purpose Sheet Feeder

The multi-purpose sheet feeder can feed plain paper, inkjet paper, glossy paper, transparencies and envelopes. When the MFC receives data from your computer, it begins the print process by loading paper from the multi-purpose sheet feeder.

- 1 Select the print command from your PC.
- 2 Your PC sends a print command and data to the MFC. The LCD shows **RECEIVING DATA**.
- 3 If there are more pages, the MFC begins to print the next page automatically.
- 4 When the MFC finishes printing all data, it returns to display the date and time.

Note

You can select paper source, paper size, and orientation in your application software. If your application software does not support your custom paper size, select the next larger paper size. Then adjust the print area by changing the right and left margins in your application software.

Simultaneous Printing and Faxing

Your MFC can print data from your computer while sending or receiving a fax, or while scanning information into the computer. However, when the MFC is copying or receiving a fax on paper, it pauses the PC printing operation, and resumes when copying or fax receiving is complete. Fax sending will continue during PC printing.

Printer Operation Key

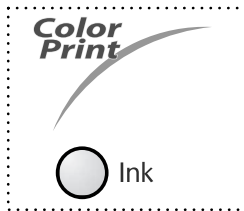

Ink Key

When you press **Ink**, the LCD shows:

1. CLEANING

If you are having trouble with one of the ink colors, you may need to clean the print head. (See page 19-9.)

2. REPLACE INK

If you got an error message **NEAR EMPTY** or **INK EMPTY**, you will need to replace the ink cartridge for the appropriate color. (See *Error Messages*, page 19-1.)

Stop/Exit Key

If the LCD shows **REMAINED DATA**, you can clear data remaining in the printer memory by pressing **Stop/Exit**.

Checking the Print Quality

If you want to check the print quality and find out how to improve it, See *How to Improve Print Quality*, page 19-9.

12 Printer Driver Settings

(For Windows® Only)

Using the Brother MFC-5100C Printer Driver

A Printer Driver is software that translates data from the format used by a computer into the format required by a particular printer, using a printer command language or page description language.

The printer drivers are on the supplied CD-ROM. The latest printer driver can also be downloaded from the Brother Solutions Center at <http://solutions.brother.com>.

Features in the Printer Driver (For Windows® 95/98/98SE/Me/2000 Professional and Windows NT® 4.0)



The screens shown in this section are from Windows® 98. The screens on your PC may vary depending on your Windows Operating System.

For more detailed information, please see the on-line Help in the printer driver.

Paper Tab

The paper tab screen allows you to set up the Paper Size, Paper Source, Paper Thickness, Orientation, Scaling, and Copy/Page Order.

To access the Brother printer driver, select **Print** from the File menu. In the Print dialog box, select **Brother MFC-5100C** from the Name drop down list. Click the Properties button. The Brother MFC-5100C on BRMFC: Properties dialog box will appear:

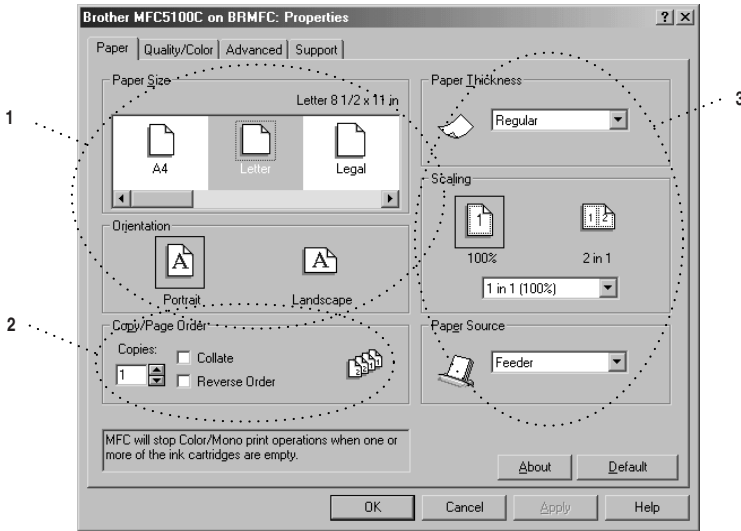

Select the **Apply** button to apply your selected settings.

To return to the default settings, click the **Default** button, then click the **Apply** button.

- 1 Select the Paper Size and Orientation.
- 2 Select number of Copies and Page Order.
- 3 Select Paper Thickness, Scaling and Paper Source.

Paper Size

The paper size selection provides a large selection of standard paper sizes or you can even create custom sizes ranging from 3.5 × 5” to 8.5 × 14”. To select the paper size you want to use click the icon.

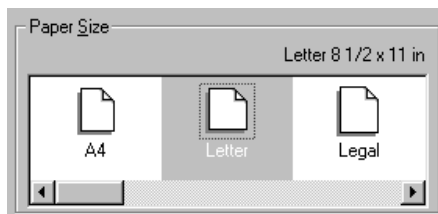

Orientation

Orientation selects the position of how your document will be printed (Portrait or Landscape).



Copy/Page Order

Copies

The copies selection sets the number of copies that will be printed (1 to 50).

Collate

With the collate check box selected, one complete copy of your document will be printed and then repeated for the number of copies you selected. If the collate check box is not selected, then each page will be printed for all the copies selected before the next page in the document is printed.

Reverse Order

Reverse Order prints the pages of your document in the opposite order.

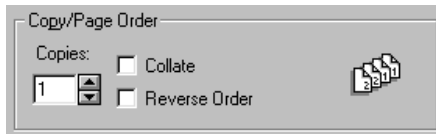

Paper Thickness

Depending on the thickness of the paper you are using, you can improve the quality of your output by selecting the correct thickness. This setting provides the best positioning of the paper for printing. For example if you were printing on thin paper, you would select **Thin** in the Paper Thickness selection to achieve the best paper handling and improved output for that paper type.

Regular

Thin

Thick

Thicker

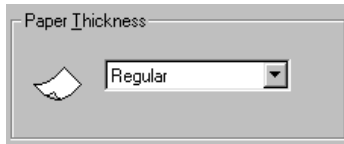

Scaling

The Scaling feature reduces or enlarges your document from 50% to 200%. From the pull-down box you can select from the preset settings or a free setting. You can also select 2 in 1 printing for printing two pages on one sheet of paper.



For Windows NT® Workstation 4.0 and Windows® 2000 Professional, you can also select 4 in 1 printing.

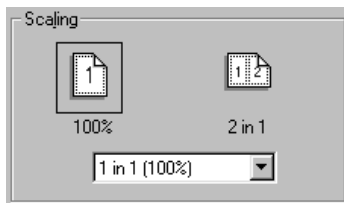

Paper Source

The Paper Source pull-down allows you to choose the source of the media you are using.

Feeder

Manual Feed

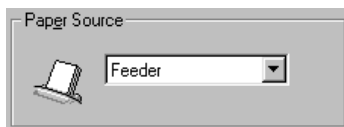

Quality/Color Tab

The Quality/Color tab screen provides Quality, Media type, Document type, Color/Mono settings, Bi-directional Printing settings and Fast Draft Mode. All of these selections are designed to offer the best quality output for your document needs.

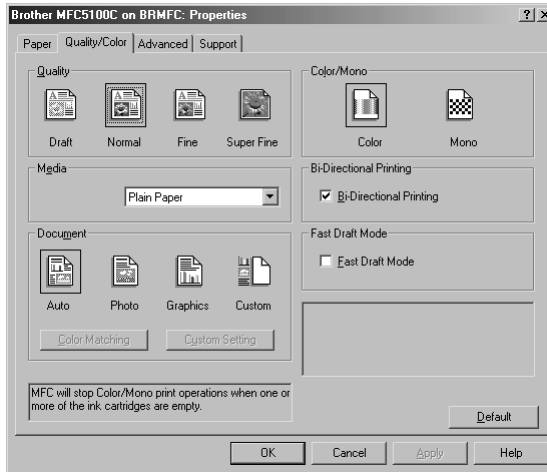

Select the **Apply** button to apply your selected settings.

To return to the default settings, click the **Default** button, then click the **Apply** button.

Quality

The quality selection allows you to choose the print resolution you want your document. Print quality and speed are related. The higher the quality the longer it will take to print the document. The quality selections available vary depending on the media selection.

- **Draft:** The fastest print mode and the lowest ink consumption. Use this mode to print large volume documents or a document for proofing.
- **Normal:** Recommended for ordinary printouts.
- **Fine:** Better print quality than normal mode and faster print speed than Super Fine.
- **Super Fine:** Use this mode to print precise images such as photographs. Since the print data is much larger than normal mode, the processing time, data transfer time and print time will be longer.

Media

To achieve the best print results, the media being printed on should be selected in the driver. The MFC changes the way it places dots, depending on the selected media type.

Paper Type	Recommended Print Quality Selection
Plain Paper	Normal
Inkjet Paper	Fine
Glossy Paper (4 color)	Super Fine
Glossy Paper (3 color)	Super Fine
Transparencies	Fine
Transparencies (mirror)	Fine



The print quality of black ink varies depending on the kind of glossy paper you are using. Black ink is used when you select **Glossy Paper (4 color)**. If the glossy paper you are using repels the black ink, select **Glossy Paper (3 color)**, which simulates black ink by combining the three ink colors.

Document

The printer driver will select the most suitable color matching method, depending on your document type. Generally, text and business graphics are printed vividly and photographic images are printed softly.

- **Auto:** The printer driver automatically selects the document type.
- **Photo:** Select this mode for photographic images.
- **Graphics:** Select this mode for documents that contain text or business graphics (charts or clip art).
- **Custom:** If you want to select the color matching method and halftone method, manually select this mode.

Color Matching

You can select the color matching method manually. Select the best one for your document.

■ Match Monitor

Suitable for photographic images. Color is adjusted to get the closest color match to the PC monitor.

■ Vivid Color

Suitable for business graphics such as charts, graphs, and text. The color is adjusted to give more vivid color.

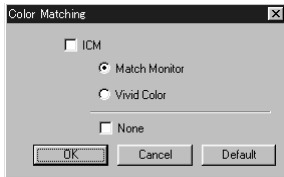

(For Windows® 95/98/98SE/Me user's)



(For Windows® 2000 Professional/
Windows NT® 4.0 user's)

Custom Setting

You can customize your settings by selecting the type of Halftone or Color Enhance/True2Life.

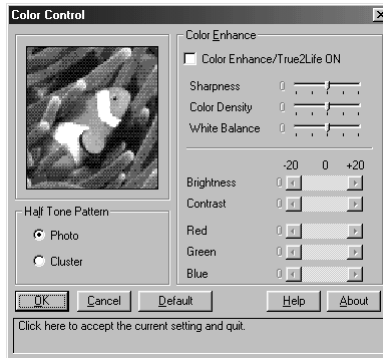

Halftone Pattern

The MFC can use several methods to arrange where to place dots to express halftones. There are some predefined patterns used to place dots and you can select which one is used for your document. Select the appropriate method.

■ Photo

This method creates smooth halftones so that this is suitable for photographic images. It takes more time to process data, but this can express more levels of halftones and creates more natural images.

■ **Cluster**

This is suitable for business graphics such as charts, graphs and drawings, since this creates more sharp printouts. Moreover, the processing time is shorter.

Color Enhance

Selecting Color Enhance/True2Life ON enables the True2Life feature. This feature analyzes your image to improve quality sharpness, white balance and color density. This process may take several minutes depending on the size of the image, the speed and RAM memory of your computer.

■ **Color Enhance/True2Life ON**

Adjusts the color in the image for better print quality. Print time will be longer with True2Life set to ON.

■ **Sharpness**

This setting enhances the detail of an image. This is similar to adjusting the fine focus on a camera. If the focus is off a little you will not be able to clearly see the fine details of an image.

■ **Color Density**

This adjusts the total amount of color in the image. You can increase or decrease the amount of color in an image to improve a picture which may appear washed out or weak.

■ **White Balance**

This adjusts the hue of the white sections of an image. Lighting, camera settings and other influences will effect the appearance of white. The white parts of a picture may appear to be slightly pink, yellow or some other color. By using this adjustment you can correct this effect and bring the white sections back to pure white.

■ **Brightness**

Change the brightness of the whole image lighter or darker. Moving the scroll bar to the left makes your image darker and moving the scroll bar to the right makes your image lighter.

■ **Contrast**

Change the contrast of an image. Darker sections will be more dark and lighter sections will be more light as you increase the contrast. Increase the contrast when you want an image to be clearer. Decrease the contrast when you want an image to be more subdued.

■ **Red**

Increase the intensity of the Red color to add red to the whole image.

■ **Green**

Increase the intensity of the Green color to add green to the whole image.

■ **Blue**

Increase the intensity of the Blue color to add blue to the whole image.

Color/Mono

This selection allows a color document to be printed in mono only.

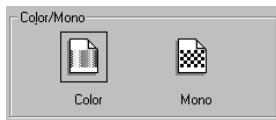

Bi-Directional Printing

When Bi-Directional Printing is selected, the print head prints in both directions and offers faster print speeds. When not selected the print head prints in one direction only and provides higher print quality.

Fast Draft Mode

You can print much more quickly than mono draft mode, by using both black and cyan ink.

Advanced Tab

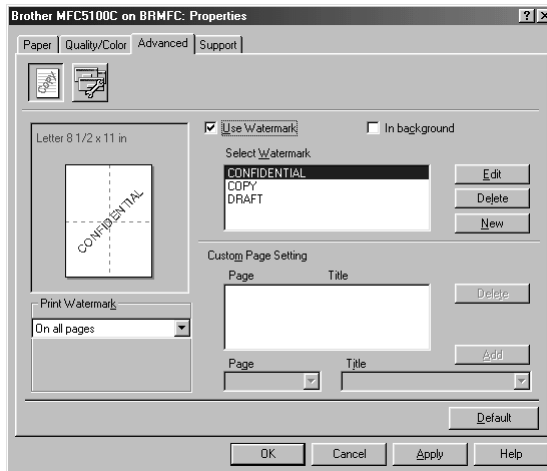

Select the **Apply** button to apply your selected settings.

To return to the default settings, click the **Default** button, then click the **Apply** button.

Change the tab settings by selecting one of the following icons:

- Watermark
- Device Options

Watermark

To place a logo or text into your document as a Watermark, use a bitmap file or text you created as your source file or select one of the preset Watermarks.

Print Watermark

The Print Watermark feature offers the following print choices:

- On all pages
- On first page only
- From second page
- Custom

In background

With the In background feature checked the Watermark will print on the page behind your document. If this feature is not checked then the Watermark will print on top of your document.

Watermark Style

You can change the Watermark's size and the position on the page by selecting the Watermark, and then clicking the **Edit** button. If you want to add a new Watermark, click the **New** button, and then select Text or Bitmap in the Watermark Style.

Watermark Text

Enter your Watermark text into the Text Box, and then select the Font, Size, Color and Style.

Watermark Bitmap

Enter the file name and location of your bitmap image in the File box or Browse for the file location. You can also set the scaling size of the image.

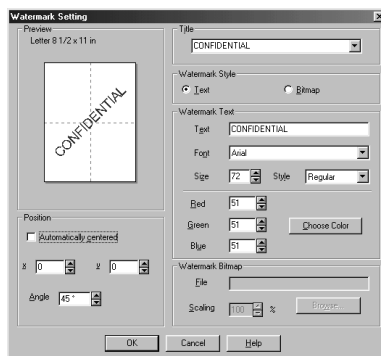

Position

The position settings offer controls for where the Watermark is positioned on the page.

Device Options

Set Print Date & Time as the Printer Function:

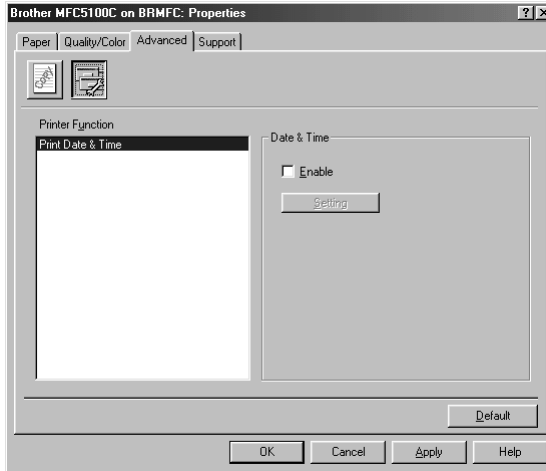

Print Date & Time

When enabled the Print Date and Time feature will automatically print the date and time from your computer's system clock on your document.

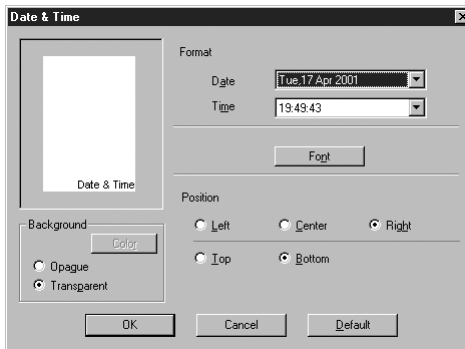

Click the Setting button to change the Date and Time Format, Position and Font. To include a background with the Date and Time, select Opaque. When Opaque is selected, you can click on the Color button to change the color of the Date and Time background.



The Date and Time indicated in the selection box shows the format that will be printed. The actual Date and Time printed on your document is automatically retrieved from the settings of your computer.

Support

The Support Tab provides driver version information and setting information. In addition there are links to the Brother Solutions Center and Driver Update Web sites.

Click the Support tab to display the following screen:



Select the **Apply** button to apply your selected settings.

To return to the default settings, click the **Default** button, then click the **Apply** button.

Web Update

Web Update checks the Brother web site for updated drivers, and then it automatically downloads and updates the printer driver on your computer.

Brother Solutions Center

The Brother Solutions Center is a Web site offering information about your Brother product including FAQs, User Guides, Driver updates and Tips for using your machine.

Features in the Printer Driver (For Windows® XP)

The Windows® XP printer driver utilizes Microsoft's uni-driver architecture. The following section describes the driver features and selections available for Windows® XP.



You can also install a Brother Native Driver as per the instructions of the Windows® XP Quick Setup Guide. For descriptions on the Printer Driver features refer to the "Features in the Printer Driver (For Windows® 95/98/98SE/Me/2000 Professional and Windows NT® 4.0 user)" section.

Layout Tab

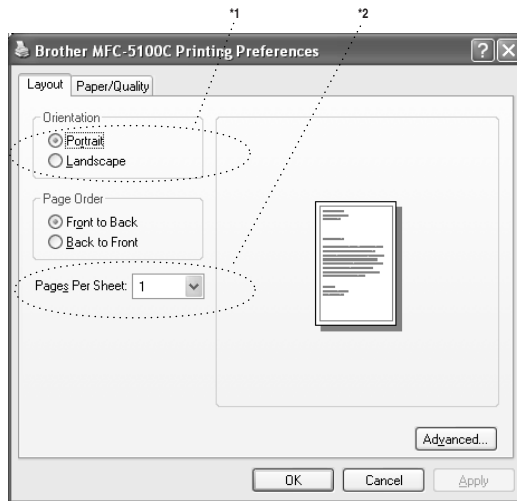

*1 Orientation

Select the Orientation, which is how your document will be positioned on the paper (Portrait or Landscape).



Portrait

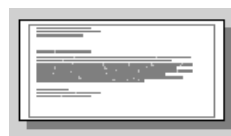

Landscape

*2 Pages Per Sheet

You can select 1, 2, 4, 6, 9 or 16 pages to be printed on one sheet of paper. The image of each page will be reduced as needed to fit on the paper.



2 in 1



4 in 1

Paper/Quality Tab

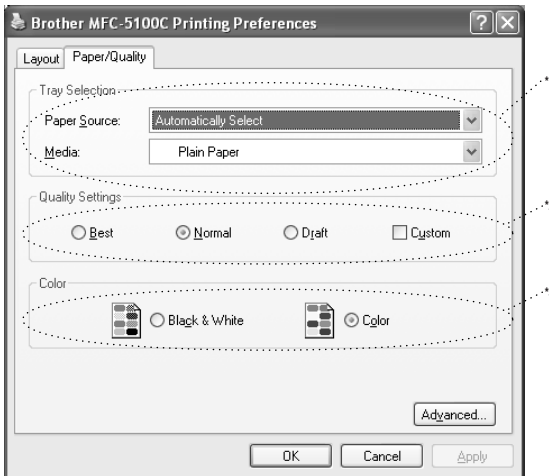

*1 Tray Selection

■ Paper Source

The machine feeds subsequent pages automatically even if you select either **Automatically Select** or **Feeder**.

■ Media

To achieve the best print results, the media being printed on should be selected in the driver. The MFC changes the way it places dots, depending on the selected media type.

Paper Type	Recommended Print Quality Selection
Plain Paper	Normal
Inkjet Paper	Fine
Glossy Paper (4 color)	Super Fine
Glossy Paper (3 color)	Super Fine
Transparencies	Fine
Transparencies (mirror)	Fine



The print quality of black ink varies depending on the kind of glossy paper you are using. Black ink is used when you select **Glossy Paper (4 color)**. If the glossy paper you are using repels the black ink, select **Glossy Paper (3 color)**, which simulates black ink by combining the three ink colors.

*2 Quality Settings

You can select from the predefined quality settings for your document. If you want to check or access additional selections for the print quality, refer to the Print Quality in the Advanced Options.

*3 Color

This selection allows a color document to be printed in Black & White only.



Advanced Options

Click the **Advanced...** button in the Layout tab or Paper/Quality tab to access the screen below:

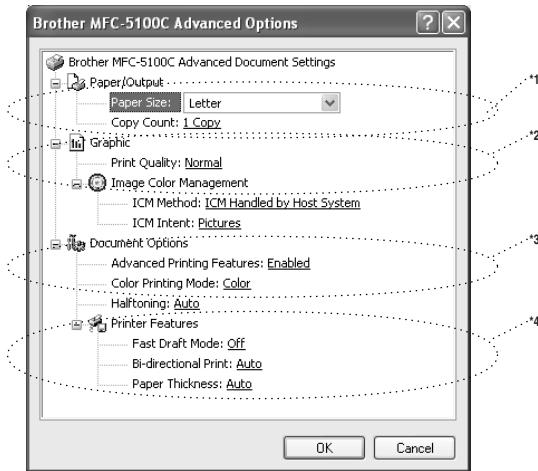

*1 Paper /Output

Paper Size - Select the paper size of the document you are printing. This size should be the same as the paper size that is set in your application software.

Copy Count - Type the number of copies you want.

*2 Graphic

Print Quality - The quality selection allows you to choose the print resolution you want for your document. Print quality and speed are related. The higher the quality the longer it will take to print the document. The quality selections available vary depending on the media selection.

Draft: The fastest print mode and the lowest ink consumption. Use this mode to print large volume documents or a document for proofing.

Normal: Recommended for ordinary printouts.

Fine: Better print quality than normal mode and faster print speed than Super Fine.

Super Fine: Use this mode to print precise images such as photographs. Since the print data is much larger than normal mode, the processing time, data transfer time and print time will be longer.



The print quality that can be selected depends on the media you selected. You can select the following quality settings for each media.

Plain Paper:	Draft, Normal, Fine, Super Fine
Inkjet Paper:	Normal, Fine, Super Fine
Glossy Paper (4 color):	Fine, Super Fine
Glossy Paper (3 color):	Fine, Super Fine
Transparency:	Fine, Super Fine
Transparency (mirror):	Fine, Super Fine

*3 Document Options

Halftone Pattern - The MFC can use several methods of arranging where dots are placed on the paper to express halftones. You can select what predefined pattern is used for your document.

Photo

This method creates smooth halftones suitable for photographic images. It takes more time to process the data, but this selection can express more levels of halftones and creates more natural images.

Cluster

This is suitable for business graphics such as charts, graphs and drawings. This selection creates sharper printouts and has a shorter processing time.

Auto

If you selected Plain Paper and the print resolution is less than Fine Quality, Auto works as Cluster. If you select another media type or a higher resolution, Auto works as Photo.

***4 Printer Features**

Fast Draft Mode - This mode prints using both black and cyan ink offering a faster print speed than mono draft mode.

Bi-directional Print - When Bi-Directional Print is set to ON, the print head prints in both directions and offers faster print speeds. When OFF is selected, the print head prints in one direction only and provides higher print quality. If you selected Plain Paper, Auto works in Bi-Directional Print mode.

Paper Thickness - Depending on the thickness of the paper you are using, you can improve the quality of your output by selecting the correct thickness. This setting provides the best positioning of the paper for printing. For example if you were printing on thin paper, you would select **Thin** in the Paper Thickness selection to achieve the best paper handling and improved output for that paper type.

Regular

Thin

Thick

Thicker

Auto

If you selected Envelops in the Print Size, Auto works as Thicker. If you select any other print size, Auto works as Regular.

13 Using the Windows®-Based Brother MFL-Pro Control Center

Brother MFL-Pro Control Center

The Brother Control Center is a software utility that pops up on the PC screen whenever paper is placed in the automatic document feeder. This allows you to quite easily, with very few mouse clicks, access the most frequently used scanning applications. Using the Control Center eliminates the need to manually launch the specific applications.

The Brother Control Center provides three categories of functions:

- 1 Scan directly to a file, E-mail, word processor or graphic application of choice
- 2 Copy operations
- 3 PC Faxing using the Brother MFL Pro PC Fax software



MFC-5100C



AutoLoad the Brother Control Center



The Control Center is initially configured to automatically load each time Windows® is started. When the Control Center is loaded, the Control

Center  icon will appear in the task bar. If you don't want the Control Center to load automatically, you can turn off AutoLoad.

 If the Control Center  icon does not appear in your task bar, you will have to launch this software.

From the **Start** menu, select **Programs**, **PaperPort**, and then double-click **Brother SmartUI POPUP**.

How to Turn Off AutoLoad

- 1 Left click the Control Center  icon and click **Show**.
- 2 When the Control Center icon appears, left click on the Smart Click  Control Center button. A dialogue box with a check box labeled “AutoLoad Pop-up” will appear:

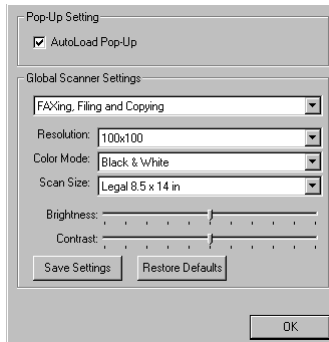

- 3 Uncheck the AutoLoad Pop-Up option.

Using the Color Scan Key

You can use the **Scan to** key on the control panel to scan originals into your word processing, graphics or E-mail applications. The advantage of using the **Scan to** key is that you avoid the mouse clicks required to scan from your PC.

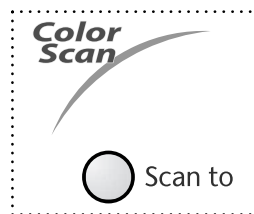

-  If you have connected a Macintosh, the **Scan to** key will not work with your computer.

Before you can use the **Scan to** key on the control panel, you must have connected the MFC to your Windows® based PC and loaded the appropriate Brother Drivers for your version of Windows®. When you are ready to use the **Scan to** key, make sure the Brother Control Center application is running on your PC. (For details about how to configure the Brother Control Center buttons to launch the application of your choice using the **Scan to** key, see *Brother Control Center Features*, pages 13-4 to 13-6.)

Scan to E-mail

You can scan either a black and white or a color original into your E-mail application as a file attachment. Although the Brother Control Center can be configured to send only black and white or color file attachments at one time, you can easily change this setting. (For details *see Scan to E-mail, pages 13-8 to 13-10.*)

- 1 Place the original face up in the ADF, or face down on the scanner glass.
- 2 Press **Scan to**.
- 3 Press  to select **SCAN TO E-MAIL**, and then press **Menu/Set**.

The MFC will scan the original, create a file attachment, and launch your E-mail application, displaying the new message waiting to be addressed.

Scan Image

You can scan a color picture into your graphics application for viewing and editing.

- 1 Place the original face up in the ADF, or face down on the scanner glass.
- 2 Press **Scan to**.
- 3 Press  to select **SCAN IMAGE**, and then press **Menu/Set**.

Scan/OCR

If your original is text, you can have it automatically converted by ScanSoft™ TextBridge® to an editable text file and then displayed in your word processing application for further editing.

- 1 Place the original face up in the ADF, or face down on the scanner glass.
- 2 Press **Scan to**.
- 3 Press  to select **SCAN/OCR**, and then press **Menu/Set**.



The MFC will scan the original perform OCR in ScanSoft™ TextBridge®, and then display the result in your word processing application for viewing and editing.

Brother Control Center Features

Auto Configuration

During the installation process the Control Center checks your system to determine the default applications for E-mail, word processing and graphics viewer/editor. For example, if you are using Outlook as your default E-mail application, the Control Center automatically will create a link and a scanning application button for Outlook.

You can change a default application by right clicking on any of the scan buttons in the Control Center and selecting a different application. For example,

you can change a scan button from MS Word  to MS Word Pad  by changing the application that is listed for the Word Processor.



Scanning Operations

Scan to File—allows you to scan directly to a disk file with two mouse clicks. You can change the file type, destination directory and file name, as needed.

Scan to E-mail—enables you, with just two mouse clicks, to scan a picture or text document directly into an E-mail application as a standard attachment. You have the option of selecting the file type and resolution for the attachment.

Scan to Word Processor—enables you to scan a text document, run ScanSoft TextBridge OCR and insert the text original (not graphic image) into a word processing file with just two mouse clicks. You have the option of selecting the destination word processing program, such as Word Pad, MS Word, Word Perfect, etc.

Scan to Graphic Application—allows you to scan an image directly into any graphic viewer/editor application. You can select the destination application, such as MS Paint or Corel PhotoPaint.

Copy Operations

Copy—allows you to use the PC and any Windows® printer driver for enhanced copy functions. You can scan the page on the Brother MFC and print the copies using any of the features of the Brother MFC printer driver—**OR**—you can direct the copy output to any standard Windows® printer driver installed on the PC.

PC Fax Operation

Send a Fax—allows you to scan a picture or text original and automatically send the image as a fax from the PC using the Brother MFL Pro fax software.

Scanner Settings for Scan, Copy and PC Fax Buttons

When the Pop-Up screen window appears, you can access the Scanner Settings window.

Click the Smart Click  icon at the top right of the Brother Control Center screen—**OR**—Click the **Modify Settings...** button on any of the Configuration screens.

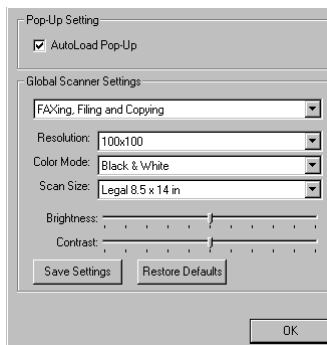

Global Settings

AutoLoad Pop-Up—Click this checkbox if you want Brother MFL Control Center to load when you boot your computer.

Setting Up the Scanner Configurations

The Pop-Up application stores eight different scanning modes. Each time you scan an original, you will choose the most appropriate scanning mode from the following:

Faxing, Filing and Copying

Text for OCR

Photos

Photos (High Quality)

Photos (Quick Scan)

Custom

Draft Copy

Fine Copy

Each mode has its own set of stored settings. You can keep the factory default settings or change them at any time:

Resolution—Select the scanning resolution you most frequently use.

Color Mode—From the pull-down list, select

Scan Size—From the pull-down list, select

Brightness—Slide the adjuster from 0% to 100%

Contrast—Slide the adjuster from 0% to 100%

Click **OK** to save your changes. If you make a mistake or later decide to return to the original default setting, just click the **Restore Defaults** button when the scanning mode is displayed.

To Access the Scanner Configurations Screen

- 1 Place the original face up in the ADF. Then the Brother Control Center screen pops up.
- 2 Right-click the appropriate Control Center button to display *Configurations...*, then click it. The configuration screen for that **Control Center** button will appear.
- 3 To save your settings, press the **OK** button—**OR**—To return to the factory default settings, press the **Restore Defaults** button.

Perform an Operation from the Control Center Screen

If you see this screen it means you left-clicked a button in the Control Center window without first placing an original in the ADF.

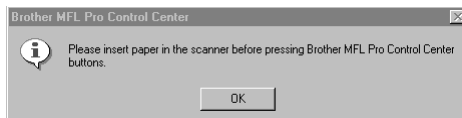

Place the original in the Brother machine's ADF, then click **OK** to return to the Control Center screen.



If you want to scan the original from the scanner glass, please use **Scan to** key on the Control Center screen.

Scan to File

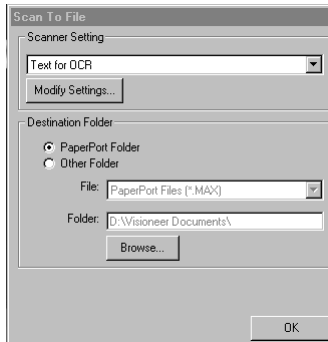

Scanner Settings

From the pull-down list, select the scanning mode that is appropriate for the type of file: Faxing, Filing and Copying; Text for OCR; Photos; Photos (High Quality); Photos (Quick Scan); Custom; Draft Copy or Fine Copy.

To change any of the settings for that mode, click the **Modify Settings...** button.

Destination Folder

PaperPort Folder—Select this checkbox to scan the original into your PaperPort folder.

Other Folder—Select this checkbox, to scan the original as another file type and/or into another directory/folder.

File—If you selected Other Folder, from the pull-down list select the type of file:

- PaperPort Files (*.MAX)
- Self Viewing Files (*.EXE)
- PaperPort 5.0 Files (*.MAX)
- PaperPort 4.0 Files (*.MAX)
- PaperPort 3.0 Files (*.MAX)
- Windows Bitmap (*.BMP)
- PC Paintbrush (*.PCX)
- Multi-page PCX (*.DCX)
- JPEG Image Files (*.JPG)
- TIFF-Uncompressed (*.TIF)
- TIFF Group 4 (*.TIF)
- TIFF Class F (*.TIF)
- Multi-Page TIFF-Uncompressed (*.TIF)
- Multi-Page TIFF Group 4 (*.TIF)
- Multi-Page TIFF Class F (*.TIF)
- PDF Files (*.PDF)
- Portable Network Graphics (*.PNG)
- FlashPix (*.FPX)
- HFX Fax Files (*.HFX)

To Search your system for the directory and folder you want, click the **Browse...** button. Click **OK** to save your settings.

Scan to E-mail

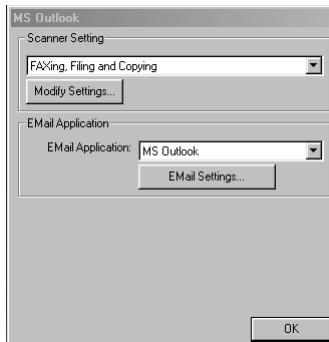

Scanner Settings

From the pull-down list, select the scanning mode that is appropriate for the type of file: Faxing, Filing and Copying; Text for OCR; Photos; Photos (High Quality); Photos (Quick Scan); Custom; Draft Copy or Fine Copy.

To change any of the settings for that mode, click the **Modify Settings...** button.

E-mail Application

E-mail Application—From the pull-down list, select your E-mail application.

E-mail Settings—Click the **EMail Settings...** button to set up links.

The Links Preferences window will appear:

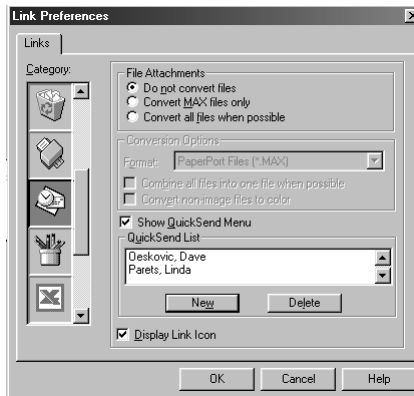

File Attachments

Do not convert files—Click this checkbox if you do not want to change the file type of attachments. The Conversion Options will not be available (grayed).

Convert MAX files only—Click this checkbox if you want to convert only attachments that are PaperPort files.

Convert all files when possible—Click this checkbox if you want to change the file type of all attachments.

Conversion Options

Format

Combine all files into one file when possible—Click this checkbox to combine all files of the same type into one file.

Convert non-image files to color—Click this checkbox to convert all files that have been processed through OCR to color.

Show QuickSend Menu

Click this checkbox if you want the Select QuickSend Recipient window to be displayed when you choose Scan to E-mail. This feature works only with MAPI type E-mail applications, such as Microsoft Exchange, Microsoft Outlook and Eudora.

QuickSend List

You can create a list of Email names and addresses for quick selection.

Click the **New** button to add a name(s) to your QuickSend list. Your Email phone book listing is displayed, so you can select stored names or create new ones:

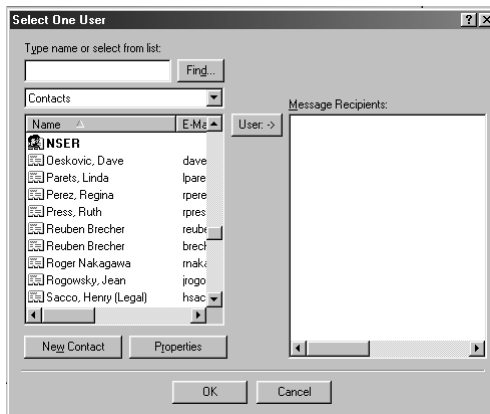

Highlight the name(s) you want to add to your list, click the **User** button, then click **OK** to return to the Link Preference window.

From the Link Preference User window, you can remove a name from the QuickSend list, highlight the name and clicking the **Delete** button.

Scan to Word Processor

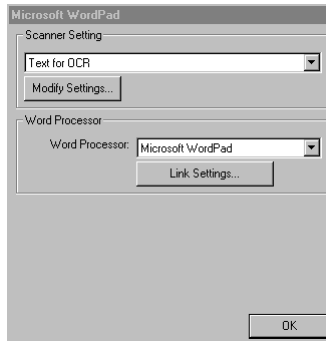

Scanner Settings

From the pull-down list, select the scanning mode that is appropriate for the type of file: Faxing, Filing and Copying; Text for OCR; Photos; Photos (High Quality); Photos (Quick Scan); Custom; Draft Copy or Fine Copy.

To change any of the settings for that mode, click the **Modify Settings...** button.

Word Processor

Word Processor—From the pull-down list, select the word processor you want to use.

Click the **Link Settings...** button to display a screen to set up a link to the version of OCR and document format that you want to use:

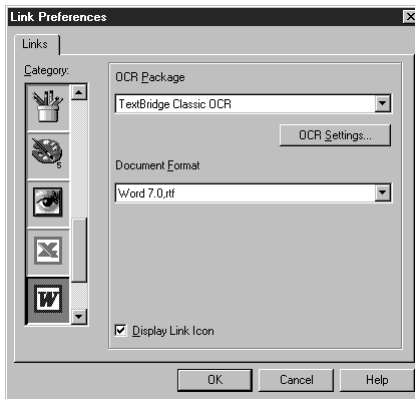

OCR Package—From the pull-down list, select *TextBridge Classic OCR* if you want to use the OCR package that was installed with the Brother software.

Click the **OCR Settings...** button to choose how the OCR application will read the pages you scan into your word processor application.

The Preferences window will appear:

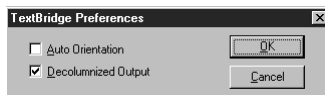

Select your setting and click **OK**.

- *Auto Orientation*—Check this checkbox if you want your word processor application to read the page as it is set up.
- *Decolumnized Output*—Check this checkbox if you want your word processor application to read across the entire page from left to right.

Document Format—From the pull-down list, select the file format you want to use for your word processor or text documents.

User Defined Button

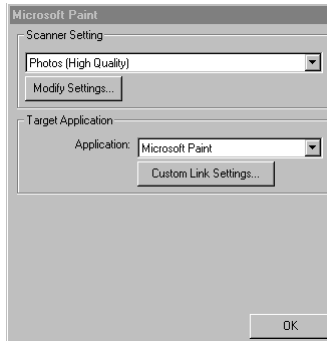

Scanner Settings

From the pull-down list, select the scanning mode that is appropriate for the type of file: Faxing, Filing and Copying; Text for OCR; Photos; Photos (High Quality); Photos (Quick Scan); Custom; Draft Copy or Fine Copy.

To change any of the settings for that mode, click the **Modify Settings...** button.

Target Application

Application—From the pull-down list, select the application you want to add to this Pop-Up screen.

Click the **Custom Link Settings...** button to set up links for your user-defined application.

Copy

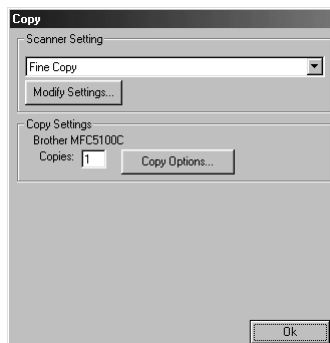

Scanner Settings

From the pull-down list, select the scanning mode that is appropriate for the type of file: Faxing, Filing and Copying; Text for OCR; Photos; Photos (High Quality); Photos (Quick Scan); Custom; Draft Copy or Fine Copy.

To change any of the settings for that mode, click the **Modify Settings...** button.

Copy Settings

Brother MFC-5100C

Copies—Enter the number of copies you want to print.

To change the copy options, click the **Copy Options...** button.

Click the **OK** button to save your Copy settings.

Send a Fax



Scanner Settings

From the pull-down list, select the scanning mode that is appropriate for the type of file: Faxing, Filing and Copying; Text for OCR; Photos; Photos (High Quality); Photos (Quick Scan); Custom; Draft Copy or Fine Copy.

To change any of the settings for that mode, click the **Modify Settings...** button.

FAX Settings

Brother PC-Fax

FAX Resolution—Fine (200 × 200)

- 1 To change the fax options, click the **FAX Options...** button.

The Brother PC-FAX Properties screen appears:

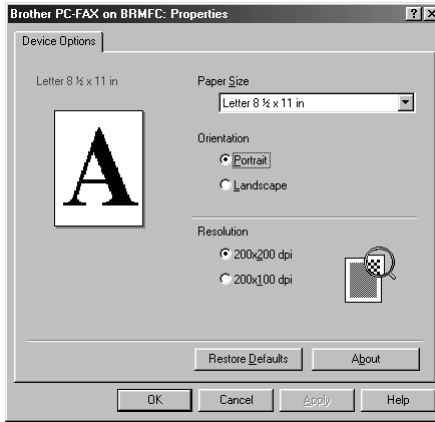

- 2 Select the *Paper Size and Orientation* (Portrait or Landscape) and click **OK**.



To return to the factory default settings, click the **Restore Defaults** button.

14 Scanner and Using ScanSoft™ PaperPort® and TextBridge® OCR

(For Windows® Only)

Using ScanSoft™ PaperPort® and TextBridge®

ScanSoft™ PaperPort® for Brother is a document management application. You will use PaperPort® to view scanned documents. PaperPort® has a sophisticated, yet easy-to-use, filing system that will help you organize your graphics and text documents. It allows you to combine or “stack” documents of different formats for printing, faxing or filing. ScanSoft™ PaperPort® can be accessed through the ScanSoft™ PaperPort® program group. See *On-Line Documentation for Multi-Function Link® Pro* on the CD-ROM.

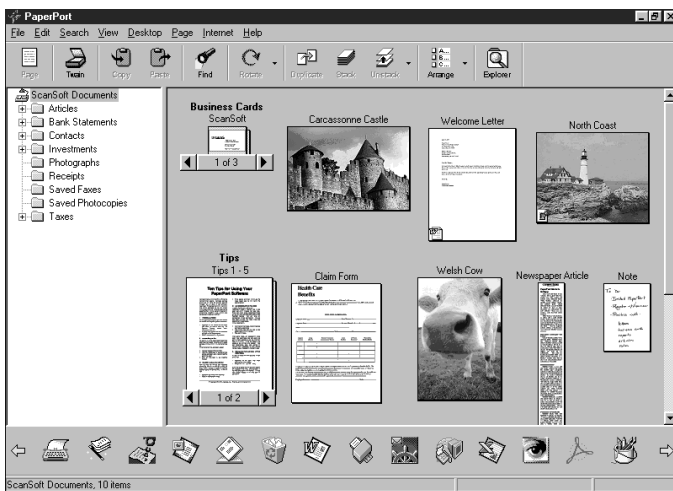

The complete ScanSoft™ PaperPort® Owner’s Manual, including ScanSoft™ TextBridge® OCR, is in the On-Line Documentation on the CD-ROM. This chapter is only an introduction to the basic operations.

When you install Multi-Function Link® Pro, ScanSoft™ PaperPort® for Brother and ScanSoft™ TextBridge® OCR are installed with it automatically.



To Uninstall PaperPort® and ScanSoft™ TextBridge

For Windows® 95/98/98SE, and Windows NT® Workstation 4.0, Windows® ME and Windows® 2000 Professional:

Select **Start, Settings, Control Panel, Add/Remove Programs** and the **Install/Uninstall** tab. Select **PaperPort®** from the list and click the **Add/Remove** button.

Viewing Items

ScanSoft™ PaperPort® provides several ways to view items:

Desktop View displays a **thumbnail**, a small graphic that represents each item in a Desktop or folder. Items in the selected folder appear on the PaperPort® Desktop. You can see PaperPort® items (MAX files) and non-PaperPort® items (files created using other applications). Non-PaperPort® items include an icon that indicates the application that was used to create the item; a non-PaperPort® item is represented by a small rectangular thumbnail and not an actual image.

Page View displays a close-up of a single page and you can open a PaperPort® item by double-clicking on it. As long as you have the appropriate application on your computer to display it, you can also double-click a non-PaperPort® item to open it.

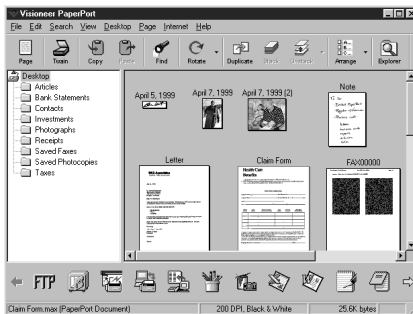

Desktop View displays items as thumbnails

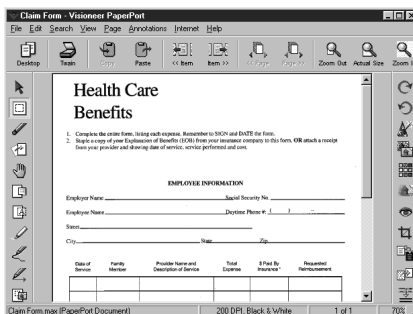

Page View displays each item as a full page

Organizing Your Items in Folders

PaperPort® has an easy-to-use filing system for organizing your items. The filing system consists of folders and items that you select to view in Desktop View. An item can be a PaperPort® item or a non-PaperPort® item:

- Folders are arranged in a “tree” structure in the Folder View. You use this pane to select folders and view their items in Desktop View.
- You can simply drag and drop an item onto a folder. When the folder is highlighted, release the mouse button and the item is stored in that folder.
- Folders can be “nested”—that is, stored in other folders.
- When you double-click a folder, its items (both PaperPort® MAX files and other files) appear on the Desktop.
- You can also use Windows® Explorer to manage the folders and items shown in Desktop View.

Links to Many Other Applications

ScanSoft™ PaperPort® automatically recognizes many other applications on your computer and creates a “working link” to them. The Link Bar at the bottom of Desktop view shows icons of those linked applications. To use a link, drag an item onto one of the icons to start the application represented by the icon. A typical use of the Link Bar is to select an item and then fax it.

This sample Link Bar shows several applications with links to PaperPort®.



If PaperPort® does not automatically recognize one of the applications on your computer, you can manually create a link using the **Create New Link** command. (See *PaperPort®* in the On-Line-Documentation on the CD-ROM for more information about creating new links.)

Using ScanSoft™ TextBridge® OCR (Converting Image Text to Text You Can Edit)

Software by: 

ScanSoft™ TextBridge® OCR is installed automatically with PaperPort® when you install Multi-Function Link® Pro on your computer.

ScanSoft™ PaperPort® can quickly convert the text on a ScanSoft™ PaperPort® item (which is really just a picture of the text) into text that you can edit with a word processing application. PaperPort® uses the optical character recognition application ScanSoft™ TextBridge®, which comes with PaperPort®—**OR**—PaperPort® uses your application if it is already on your computer. You can convert the entire item, or by using the **Copy As Text** command, you can select only a portion of the text to convert.

Dragging an item onto a word-processing link icon starts PaperPort®’s built-in OCR application, or you can use your own OCR application.



Importing Items from Other Applications

In addition to scanning items, you can bring items into PaperPort® in a variety of ways and convert them to PaperPort® (MAX) files in several different ways:

- Print to the Desktop View from another application, such as Microsoft Excel.
- Import files saved in other file formats, such as Windows® Bitmap (BMP) or Tag Image File Format (TIFF).

Exporting Items in Other Formats

You can export or save PaperPort® items in several popular file formats, such as BMP, JPEG, TIFF, or self-viewing. For example, to create a file for an Internet Web site, export it as a JPEG file. Web pages often use JPEG files for displaying images.

Exporting an Image File

- 1 Select the Export command from the File pull-down menu in the PaperPort® window. The Export 'XXXXX' As dialog box will be displayed.
- 2 Select the drive and directory where you want to store the file.
- 3 Enter the new file name and choose the file type or select a name from the File Name text box. (You can scroll through the Directories and File Name listing for prompting.)
- 4 Select the **OK** button to save your file, or **Cancel** to return to the PaperPort® without saving it.

Scanning a Document

TWAIN Compliant

The Brother Multi-Function Link® Pro software includes a TWAIN compliant scanner driver. TWAIN drivers meet the standard universal protocol for communicating between scanners and software applications. This means that not only can you scan images directly into the PaperPort® viewer that Brother included with your MFC, but you can also scan images directly into hundreds of other software applications that support TWAIN scanning. These applications include popular programs like Adobe Photoshop®, Adobe PageMaker®, CorelDraw and many more.

Accessing the Scanner

To choose **TWAIN-32 Brother MFL Pro Color** as your scanner driver, select it under the Select scanner—**OR**—Select source option in your software.

From the PaperPort® window, select **Acquire** from the File drop-down menu or select the **TWAIN** or **Scan** button. The TWAIN-32 Brother MFL-Pro Color Setup dialog box will appear:

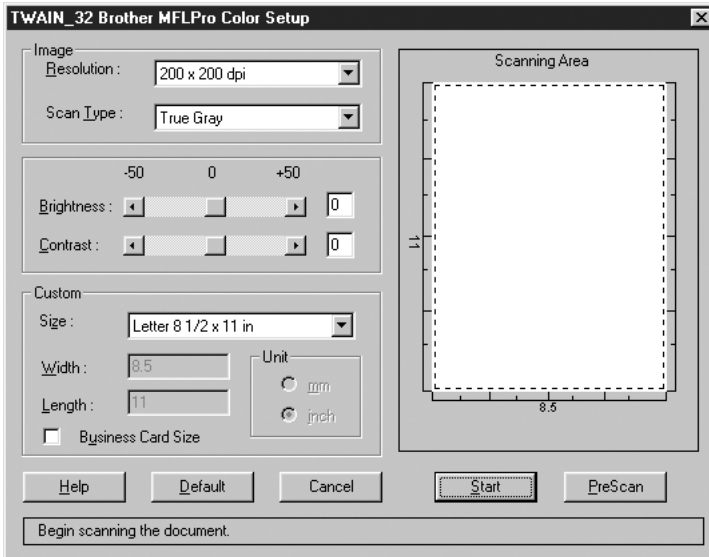

Scanning a Document into the PC

- 1 Place the original face up in the ADF, or face down on the scanner glass.
- 2 Adjust the following settings, if needed, in the Scanner window:
 - *Resolution*
 - *Scan Type* (Black & White, Gray [Error Diffusion], True Gray, 256 Color or 24-bit color)
 - *Brightness*
 - *Contrast*
 - *Size*
- 3 Select the **Start** button from the scanner window.

When scanning is completed, press **Cancel** to return to the PaperPort® window.

Settings in the Scanner Window

Resolution:

Select the scanning resolution from the Resolution drop down list. Higher resolutions take more memory and transfer time, but can achieve a finer scanned image. You can choose:

- 100 × 100 dpi
- 150 × 150 dpi
- 200 × 200 dpi
- 300 × 300 dpi
- 400 × 400 dpi
- 600 × 600 dpi
- 1200 × 1200 dpi (Black & white, Gray [Error Diffusion], True Gray and 24-bit color only)
- 2400 × 2400 dpi (Black & white, Gray [Error Diffusion], True Gray and 24-bit color only)
- 4800 × 4800 dpi (Black & white, Gray [Error Diffusion], True Gray and 24-bit color only)
- 9600 × 9600 dpi (Black & white, Gray [Error Diffusion], True Gray and 24-bit color only)

Scan Type:

Black & White: Set the Scan Type to Black & White for text or line art.

Gray Scale: For photographic images, set the Scan Type to Gray (Error Diffusion) or True Gray.

Colors: Choose either 256 Color, which scans up to 256 colors, 24-bit color which scans up to 16.8 million colors. Although using 24-bit color creates an image with the most accurate colors, the image file will be approximately three times larger than a file created with 256 Color.

Brightness:

Brightness: Adjusting the brightness settings to obtain the best image. The Brother Multi-Function Link[®] Pro offers 100 brightness settings (-50 to 50). The default value is 0, representing an “average” setting.

You can set the brightness level by dragging the slider to the right to lighten the image or to the left to darken the image. You can also type a value in the box to set the settings.

If the scanned image is too light, set a lower brightness value and scan the document again.

If the image is too dark, set a higher brightness value and scan the document again.

Contrast:

The contrast setting is adjustable only when you have selected one of the gray scale settings, but it is not available when Black & White is selected as the gray Scale.

Increasing the contrast level (by dragging the slider to the right) emphasizes dark and light areas of the Image, while decreasing the contrast level (by dragging the slider to the left) reveals more detail in gray areas. Instead of using the slider, you can type a value in the box to set the contrast.

Size:

Set the Size to one of the following:

- Letter (8 1/2 × 11 in.)
- A4 (210 × 297 mm.)
- Legal (8 1/2 × 14 in.)
- A5 (148 × 210 mm.)
- B5 (182 × 257 mm.)
- Executive (7 1/4 × 10 1/2 in.)
- Business Card (90 × 60 mm.)
- Custom (User adjustable from 0.35 × 0.35 in. to 8.5 × 14 in.)

After you select a custom size, you can adjust the scanning area further by using the left mouse button to drag the dotted outline of the scanning area. This is required when you want to crop an image when scanning.

To scan business cards, select the Business Card size setting (90 × 60 mm), and then place the business card face down at the center of scanner glass.



Carrier sheets are available from your Dealer.

When scanning photographs or other images for use in a word processor or other graphics application, you should try different settings for the contrast, mode and resolution to see which settings best suit your needs.

Custom:

If you selected **Custom** as the size, type the **Width** and **Length**.

Or, you can check the Business Card Size box to adjust the scanning area to business card or a custom size automatically.

PreScanning an Image

PreScanning allows you to scan an image quickly at a low resolution. A thumbnail version of the image will appear in the Scanning Area. This is only a preview of the image so you can see how it will look. The PreScan button is used to preview an image for cropping any unwanted portions from the image. When you are satisfied with the preview, select the **Start** button from the scanner window to scan the image.

How to Use PreScan to Adjust an Image:

- 1 Place the original face up in the ADF, or face down on the scanner glass.
- 2 In the Twain-32 Brother MFL Pro Color Setup dialog box, click the **PreScan** button.
The entire original will be scanned into the PC and will appear in the Scanning Area.

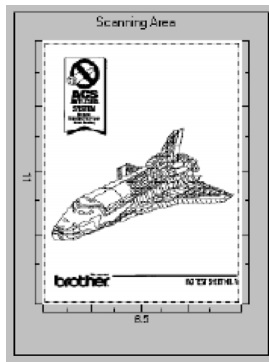

PreScanned Image

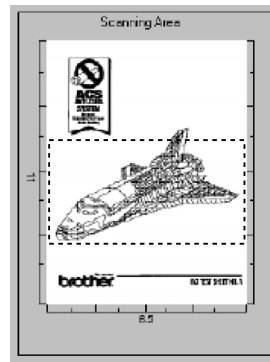

Cropped Image

- 3 To crop a portion of the original to be scanned, drag any side or corner of the dotted outline in the Scanning Area with the left mouse button. Adjust the dotted outline until it surrounds only the portion of the original you wish to scan.
- 4 Place the original face up in the ADF again, if you used the ADF in step 1.
- 5 Adjust the settings for Resolution, Scan Type and Size in the Scanner window, as needed.
- 6 Click **Start**.
This time only the selected area of the original will appear in the PaperPort® window.
- 7 In the PaperPort® window, use the options available to refine the image. (See PaperPort® for Brother Online Documentation on the CD-ROM for details.)

15 Setting Up and Using PC FAX

(For Windows® Only)

Introduction

This chapter outlines the basics of the Brother software, so you can get started using the Multi-Function Link® Pro Suite software. Detailed installation and setup instructions are in the On-Line Documentation section of the Brother CD-ROM that is included with your MFC.

Check the online **README.WRI** file in the root directory of the CD-ROM for last-minute important information and troubleshooting tips that were not included in the On-Line Documentation.

Multi-Function Link® Pro Suite software for your MFC includes ScanSoft™ PaperPort® for Brother and ScanSoft™ TextBridge®. (See Chapter 14 *Scanner and Using ScanSoft™ PaperPort® and TextBridge® OCR (For Windows® Only).*)

Brother Resource Manager

The Brother Resource Manager application must be running for you to use your MFC with your Windows® computer. Multi-Function Link® Pro Suite software and the MFL Pro Suite Printer Driver automatically load the Resource Manager, as needed. The Resource Manager allows the single bi-directional Parallel port on the MFC to simulate a Communications port for faxing and scanning and to simulate a Parallel port for Windows® GDI printing.

MFC Remote Setup

The MFC Remote Setup application allows you to quickly set up your MFC by taking advantage of the ease and speed of programming on your PC. When you access this application, the settings on your MFC will be downloaded automatically to your PC and displayed on your computer screen. If you change the settings, you can upload them directly to the MFC.

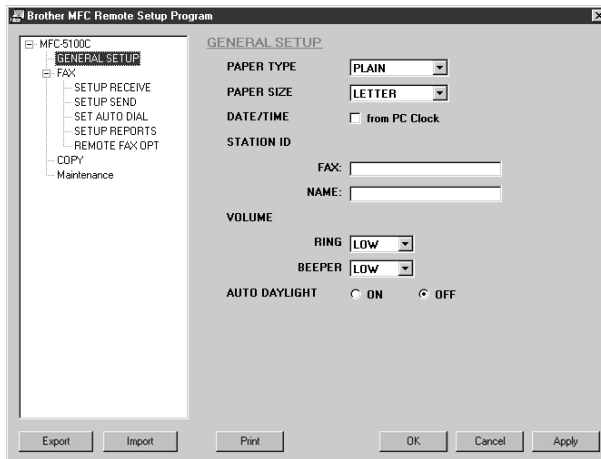

OK

This starts the process of uploading the data to the MFC and exiting the remote setup program. If an error message is displayed enter the correct data again, then click **OK**.

Cancel

This exits the remote setup application without uploading the data to the MFC.

Apply

This uploads the data to the MFC, but does not exit the remote setup application.

Print

This command prints the selected items on the MFC. You can not print the data until it is uploaded to the MFC. Click **Apply** to upload the new data to the MFC and click **Print**.

Export

This command saves the current configuration settings to a file.

Import

This command reads the settings from a file.



You can check the Ink Status in the Maintenance menu.

PC FAX Sending (For Windows® Only)

The Brother PC FAX feature allows you to use your PC to send a file. You can create a file in any application on your PC, and then send it as a PC FAX. You can even attach a cover page note. All you have to do is set up the receiving parties as Members or Groups in your PC FAX Address Book. Then you can use the Address Book Search feature to quickly find them to address your fax.



PC FAX is available in Black & White only.

Setting Up User Information

- 1 From the **Start** menu, select **Programs, Brother, Brother MFL Pro Suite**, and then select **PC-FAX Setting**.



You can access the User Information from the FAX Sending dialog box by clicking . (See *Sending a File as a PC-FAX Using the Facsimile Style*, page 15-14.)

The Brother PC Fax Setup dialog box will appear:

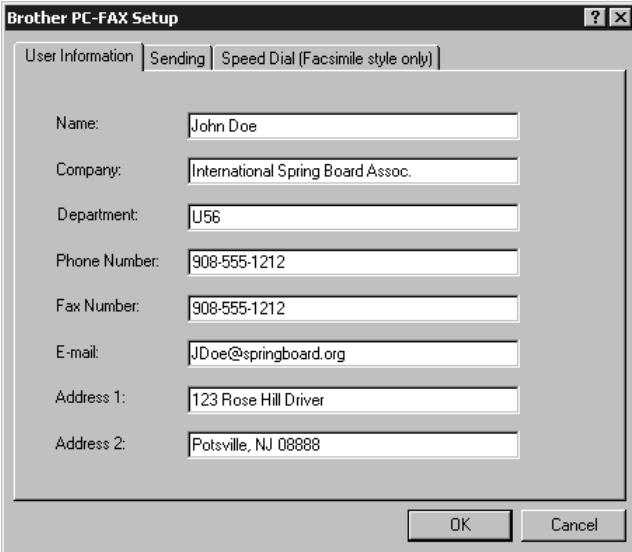

Field	Value
Name:	John Doe
Company:	International Spring Board Assoc.
Department:	U56
Phone Number:	908-555-1212
Fax Number:	908-555-1212
E-mail:	JDoe@springboard.org
Address 1:	123 Rose Hill Driver
Address 2:	Potsville, NJ 08888

- 2 Enter the required User information. This information is required to create the Fax Header and Cover Page.
- 3 To save the User Information, click **OK**.

Setting Up Sending

To access the Sending tab from the Brother PC-FAX Setup dialog box, click the **Sending** tab.

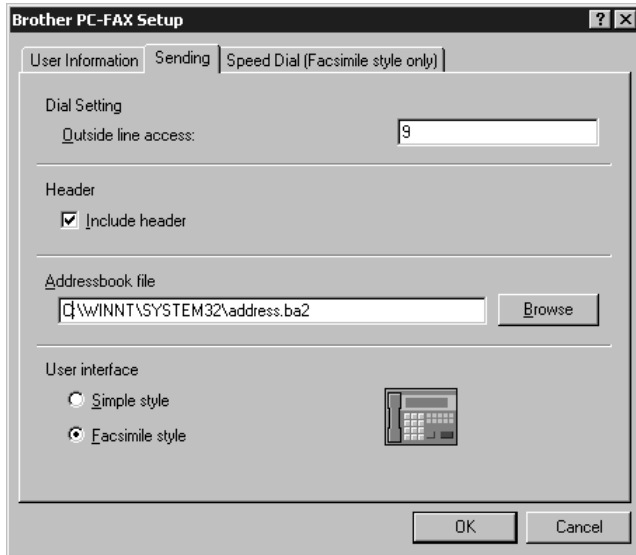

Outside Line Access

Enter the number needed to access an outside line. This is sometimes required by the local PBX telephone system.

Include Header

To add header information to the top of the fax pages being sent, check the Header box.

Address Book File

You can select different database files for use with the Address Book. You must enter the path and file name of the database file or use the Browse button to view the file system to select the file.

User Interface

Select the User Interface in the Sending tab. You have a choice of the Simple Style or the Facsimile Style.

Simple Style

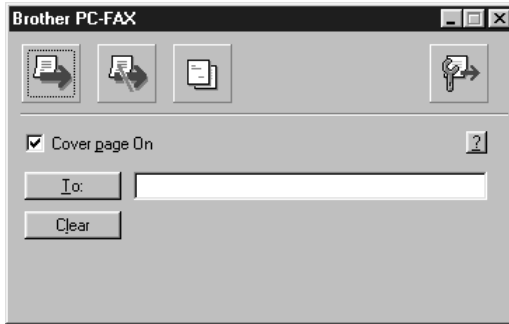

Facsimile Style



Setting Up Speed Dial

Access the Speed Dial tab from the Brother PC-FAX Setup dialog box by clicking the **Speed Dial** tab. (To use this feature you must select the Facsimile Style user interface.)

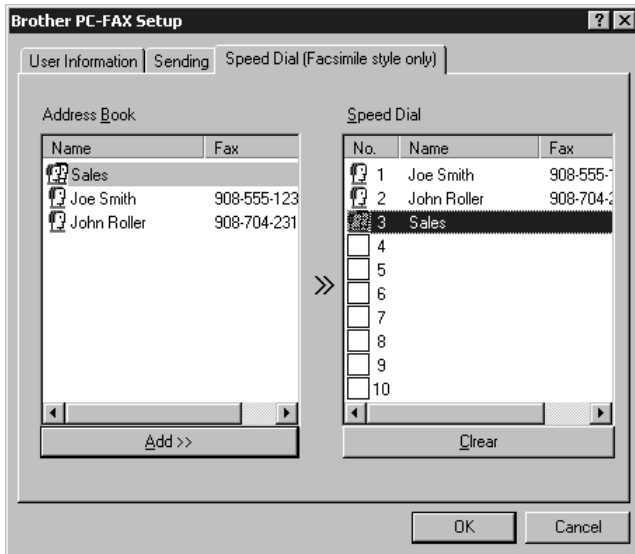

You can register any address or group on one of the ten Speed Dial buttons.

To register an address in a Speed Dial location:

- 1 Click the Speed Dial location you want to program.
- 2 Click the address or group you wish to assign to the Speed Dial location.
- 3 Click **Add >>** to program the Speed Dial location.

To clear a Speed Dial location:

- 1 Click the Speed Dial location you want to clear.
- 2 Click **Clear**.

The Address Book

From the **Start** menu, select **Programs, Brother, Brother MFL Pro Suite**, and then click **Address Book**.

The Brother Address Book dialog box will appear:

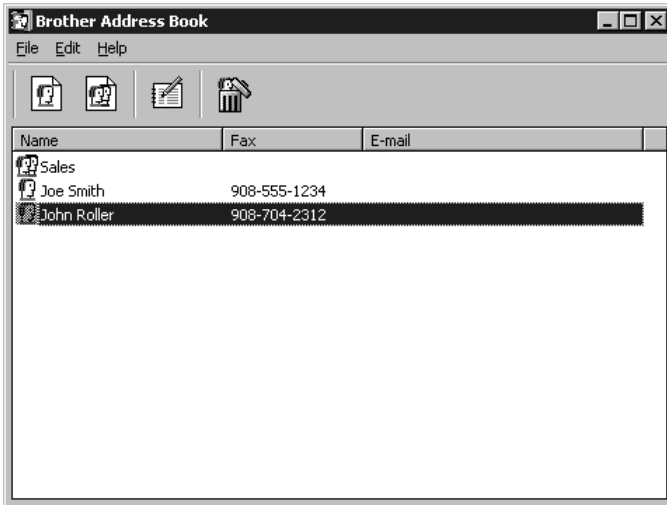

Setting Up a Member in the Address Book

In the Brother Address Book dialog box you can add, edit and delete stored information for members and groups.

- 1 In the Address Book dialog box, click the  icon to add a member. The Brother Address Book Member Setup dialog box will appear:

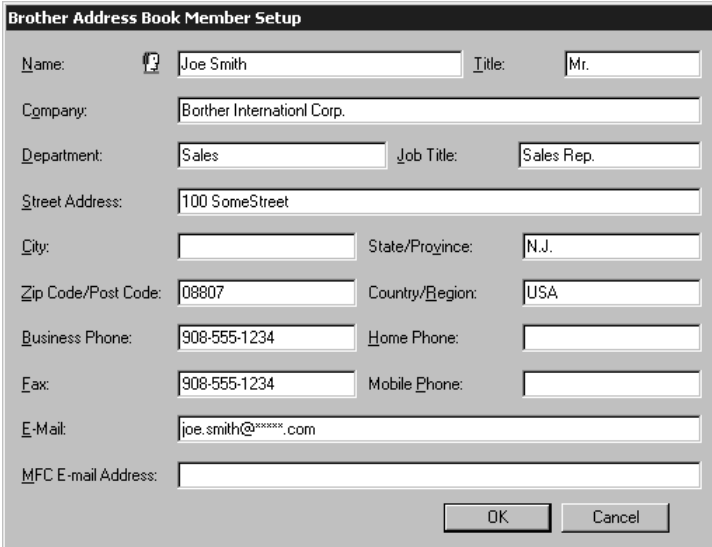

Name:	<input type="text" value="Joe Smith"/>	Title:	<input type="text" value="Mr."/>
Company:	<input type="text" value="Borther International Corp."/>		
Department:	<input type="text" value="Sales"/>	Job Title:	<input type="text" value="Sales Rep."/>
Street Address:	<input type="text" value="100 SomeStreet"/>		
City:	<input type="text"/>	State/Province:	<input type="text" value="N.J."/>
Zip Code/Post Code:	<input type="text" value="08807"/>	Country/Region:	<input type="text" value="USA"/>
Business Phone:	<input type="text" value="908-555-1234"/>	Home Phone:	<input type="text"/>
Fax:	<input type="text" value="908-555-1234"/>	Mobile Phone:	<input type="text"/>
E-Mail:	<input type="text" value="joe.smith@*****.com"/>		
MFC E-mail Address:	<input type="text"/>		

OK Cancel

- 2 In the Brother Address Book Member Setup dialog box, type the member's information. **Name** and **Fax** are required fields. Click **OK** to save the member's information.

Setting Up a Group for Broadcasting

If you repeatedly send the same PC-FAX to multiple recipients, you can combine members into a Group.

- 1 In the Brother Address Book dialog box, click the  icon to create a group. The Brother Address Book Group Setup dialog box appears:

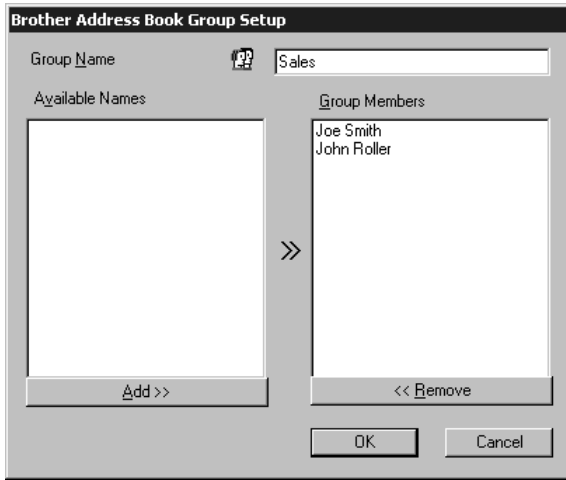

- 2 Type the name of the new group in the **Group Name** field.
- 3 In the **Available Names** box, select each member to be included in the Group, and then click **Add >>**.
Members you add to the group will be listed in the Group Members box.
- 4 After all the members have been added, click **OK**.

Editing Member Information

- 1 Select the Member or Group you want to edit.
- 2 Click the edit  icon.
- 3 Edit the Member or Group information.
- 4 Click **OK** to save your changes.

Deleting a Member or Group

- 1 Select the Member of Group you want to delete.
- 2 Click the delete  icon.
- 3 Click **OK** when the Delete OK? Dialog box appears.

Exporting the Address Book

You can export the Address Book to an ASCII text file (*.csv). If you wish, you can create a Vcard for selected members that will be attached to all the sender's outgoing e-mail; a Vcard is an electronic business card that contains the sender's contact information.

To export the current telephone book:

 If you are creating a Vcard, you must first select the member.

- 1 From the Address Book select **File**, point to **Export**, and then click **Text** —**OR**—Click **Vcard** and go to Step 5.
- 2 Select the data fields you wish to Export from the **Available Items** column, and then click **Add >>**.

 Select items in the order you want them listed.

- 3 If you are exporting to an ASCII file, select **Divide Character - Tab** or **Comma**. This selection inserts a Tab or Comma between each data field when it is Exported.
- 4 Select **OK** to save the data.

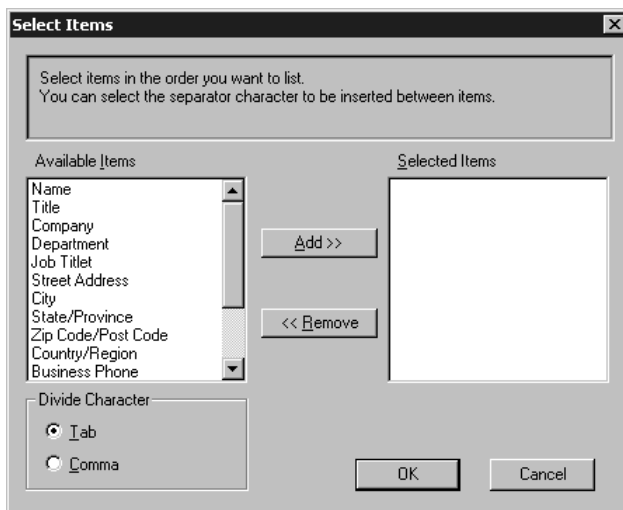

- 5 Type the name of the file, and then select **Save**.

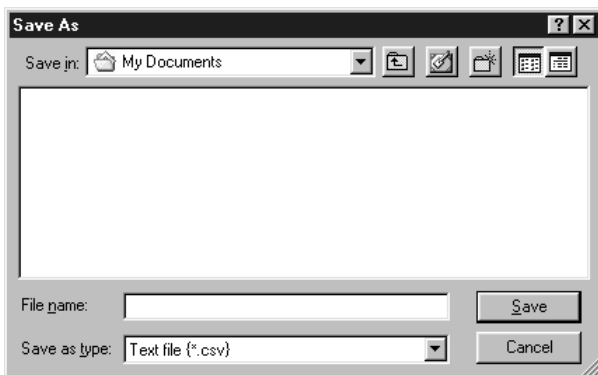

Note If you selected Vcard in Step 1, the **Save as type:** will be **Vcard (*.vcf)**.

Importing to the Address Book

You can import ASCII text files (*.csv) or Vcards (electronic business cards) into your Address Book.

To import an ASCII text file:

- 1 From the Address Book select **File**, point to **Import**, and then click **Text** —**OR**—Click **Vcard** and go to Step 5.

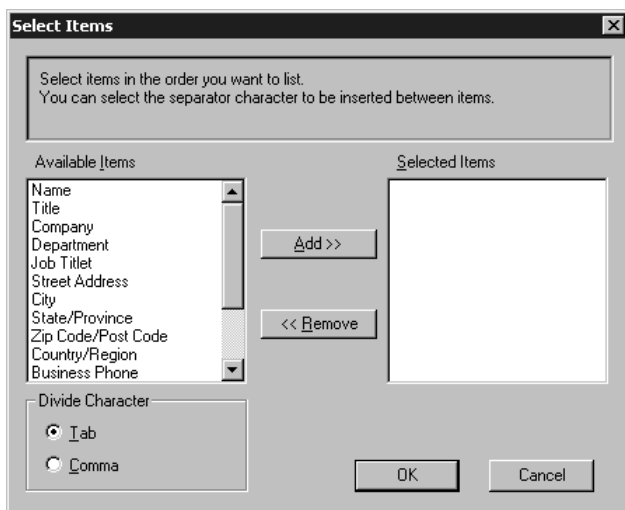

- 2 Select the data fields you wish to Import from the **Available Items** column, and then click **Add >>**.

Note Select the fields from the Available Items list in the same order they are listed in the Import text file.

- 3 Select **Divide Character - Tab** or **Comma** based on what file format you are importing.
- 4 Select **OK** to import the data.
- 5 Type the name of the file, and then select **Open**.

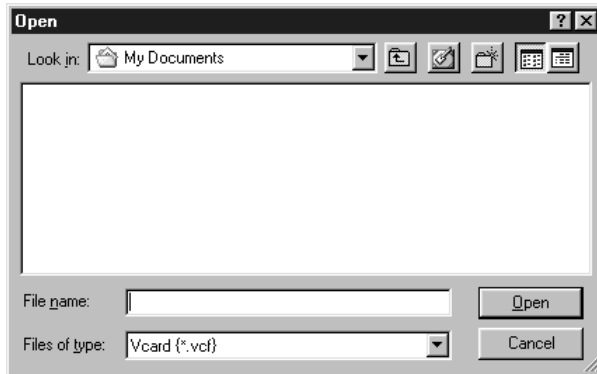

 If you selected a text file in Step 1, the **Files of type:** will be **Text file (*.csv)**.

Setting Up a Cover Page

Access the Brother PC-FAX Cover Page Setup from the PC-FAX dialog box by clicking . (See *Sending a File as a PC-FAX Using the Facsimile Style*, page 15-14.)

The Brother PC-FAX Cover Page Setup dialog box will appear:

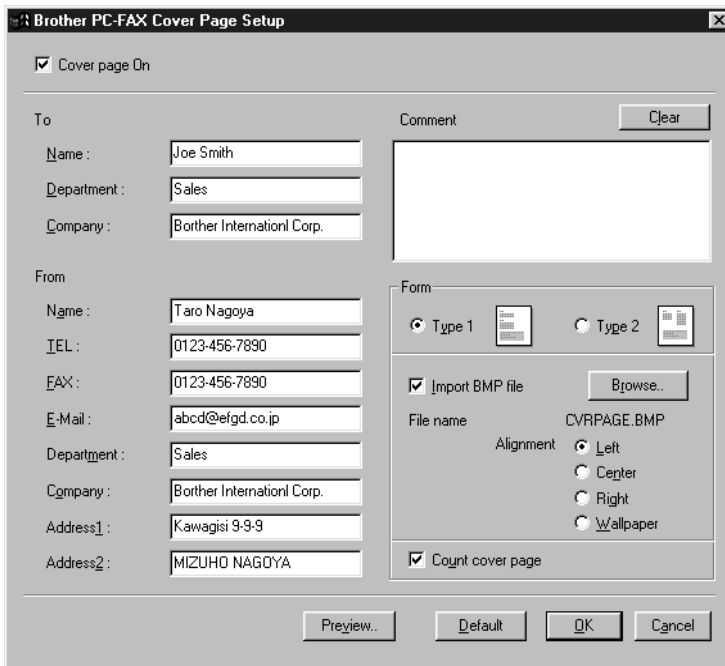

To

You can enter information in each field.



If you are sending a fax to multiple recipients, the recipient information will not be printed on the Cover Page.

From

You can enter information in each field.

Comment

Type the comment you want to add to the cover page.

Select Cover Page Form

Select the cover page form you want.

Import BMP file

You can insert a bitmap file, such as your company logo, in the cover page.

Select the BMP file by using the browse button, and then select the alignment style.

Count Cover Page

When the Count Cover Page box is checked, the Cover Page will be included in the page numbering. When this box is not checked, the Cover Page will not be included.

Sending a File as a PC-FAX Using the Facsimile Style

- 1 Create a file in Word, Excel, Paint, Draw or any other application on your PC.
- 2 From the **File** menu, select **Print**.
The Print dialog box will appear:

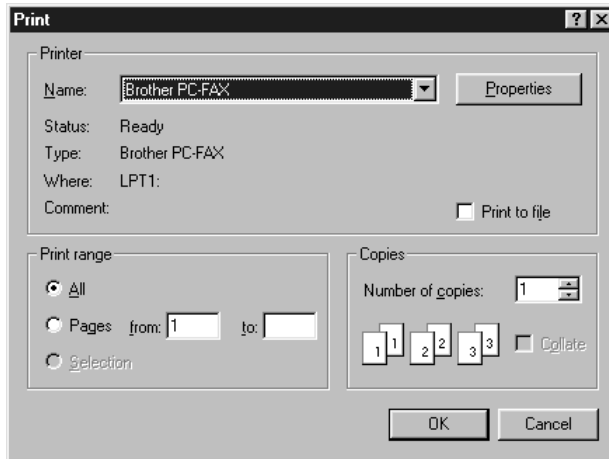

- 3 Select **Brother PC-FAX** as your printer, and then click **OK**.
The FAX Sending dialog box will appear:



- 4 Enter the fax number by using any of the following methods:
- Enter the number using the dial pad.
 - Click any of the 10 **Speed Dial** buttons.
 - Click the **Address Book** button, and then select a Member or Group from the Address Book.

 If you make a mistake you can click **Clear** to clear all the entries.

- 5 To include a cover page, click  **Cover Page On**, and then click the Cover Page  icon to enter or edit the cover page information.

- 6 Click **Start** to send the fax.

 If you wish to cancel the fax, click **Stop**.

Redial

If you want to redial a number, click **Redial** to scroll through the last five fax numbers, and then click **Start**.

Sending a File as a PC-FAX Using the Simple Style

- 1 Create a file in Word, Excel, Paint, Draw or any other application on your PC.
- 2 From the **File** menu, select **Print**.

The Print dialog box will appear:

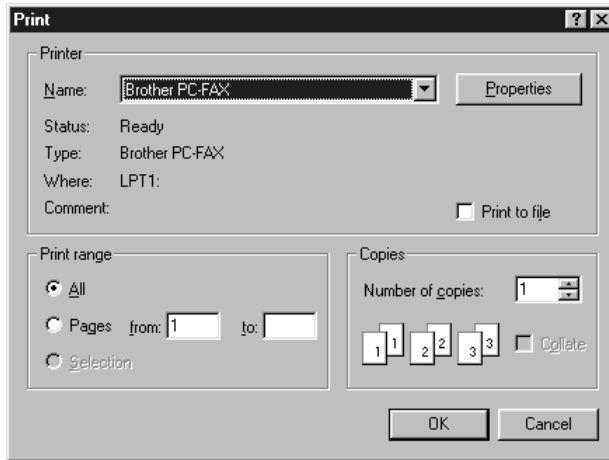

- 3 Select **Brother PC-FAX** as your printer, and then click **OK**.

The FAX Sending dialog box will appear:

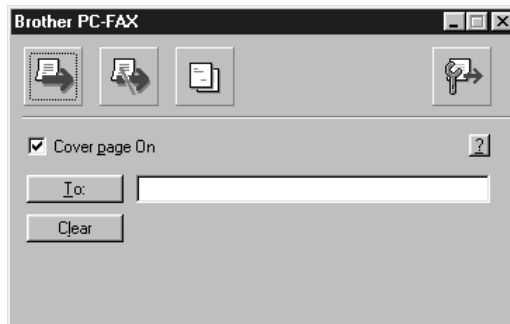

- 4 In the **To:** field, type the fax number of the receiving party. You can also use the Address Book to select destination fax numbers by clicking **To:** button. If you made a mistake entering a number, click the **Clear** button to clear all entries.
- 5 To send a Cover Page and note, check **Cover Page On**.



You can also click the  to enter or edit the cover page information.

6 When you are ready to send your fax, click the Send  icon.

7 If you wish to cancel the fax, click the Cancel  icon.

16 Using Automatic E-Mail Printing

For Windows® 95, 98, 98SE, Me Only

Main Features

- You can use Automatic E-Mail Printing with other E-mail software: Brother Automatic E-Mail Printing has some extra functions that other E-mail software, such as Netscape Navigator™ or MS Internet Mail, do not support.
- Automatic E-Mail Printing can be configured for a multiple user account: In Brother Automatic E-Mail Printing you can set up more than one e-mail account on a single PC so you can print e-mail in each account automatically.
- Automatic access to your specified POP3 server at the specified time: You can specify the time when the Brother Automatic E-Mail Printing automatically accesses the server to check for new mail.
- Provides an “In Memory” printer driver: You can receive and print e-mail data at the same time, by searching for a specified character string in the mail header. It allows you to see the sender, subject and relevant part of the mail content.

Before You Use this Software

Please read *Using Automatic E-Mail Printing* in the **On-Line Documentation** on the CD-ROM. Check the online README.WRI file in the root directory of the CD-ROM for last-minute important information and troubleshooting tips not included in the On-Line Documentation.

To Access the On-Line Documentation



After you have installed the Brother driver(s) for your model and operating system, click **View On-Line Documentation** for operating instructions.

To Install Automatic E-mail Printing (Optional Application)

- 1 Insert MFL Pro CD-ROM into your CD-ROM drive.
- 2 Click on **Install Software** from the main CD-ROM screen.
- 3 Click **Automatic E-mail Printing**.



This is optional software and will not be required for printing, faxing and scanning operations.

The Automatic E-mail Print option is NOT available for Windows NT® 4.0 and Windows® 2000 Professional.

17 Using the Brother MFC with a New Power Macintosh® G3, G4 or iMac™/iBook™

Set Up Your USB-Equipped Apple® Macintosh® G3, G4 or iMac™ or iBook™ with Mac OS 8.5-9.2

Note: Before you can connect the MFC to your Macintosh®, you must purchase a USB cable that is no longer than 6 feet (1.8 meters).

To work with your MFC, your USB-Equipped Apple® Macintosh® must be set up with Mac OS 8.5-9.2. (The Brother Scanner Driver works only with Mac OS 8.6-9.2)

Using BrotherShare Printer Driver with Your Apple® Macintosh®

To select the Printer:

- 1 From the Apple menu, open the **Chooser**.

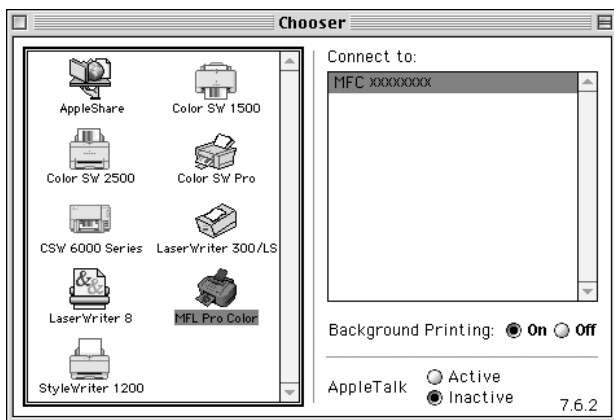

- 2 Click the **MFL Pro Color** icon. On the right side of the Chooser, click the printer to which you want to print. Close the Chooser.

To print the document:

- 3 From application software such as PaperPort®, click *File menu* and select *Page Setup*. You can change the settings for **Paper Size**, **Paper Thickness**, **Paper Source**, **Orientation**, and **Scaling**, then click **OK**.

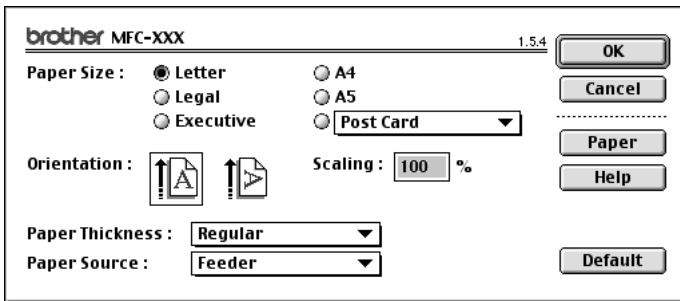

- 4 From application software such as PaperPort, click *File menu* and select *Print*. Click **Print** to start printing.

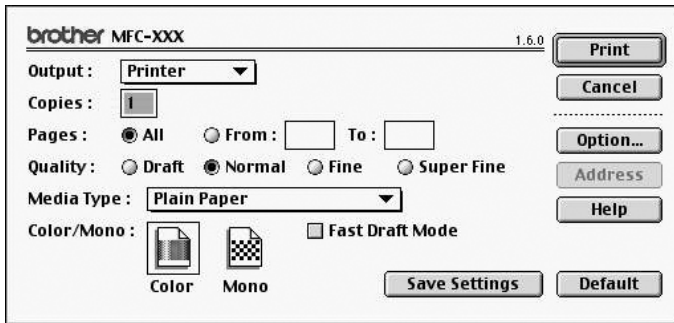

Note If you want to change **Copies**, **Pages**, **Quality**, **Media Type** and **Color/Mono**, select your settings before clicking **Print**.

Option Setup allows you to change **Document** and **Printing Options**.

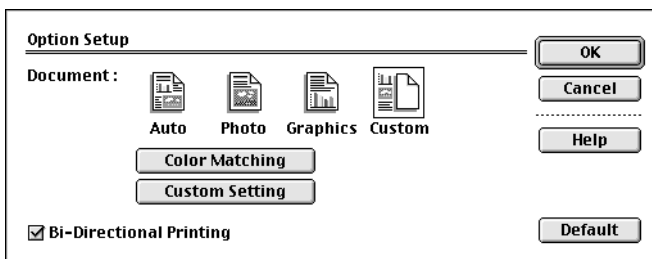

Sending a Fax from Your Macintosh® Application

You can send a fax directly from your Macintosh® application using the following steps:

- 1 Create a document in a Macintosh application.
- 2 To begin the fax transmission, select **Print** from the **File** menu. The Printer dialog box appears:

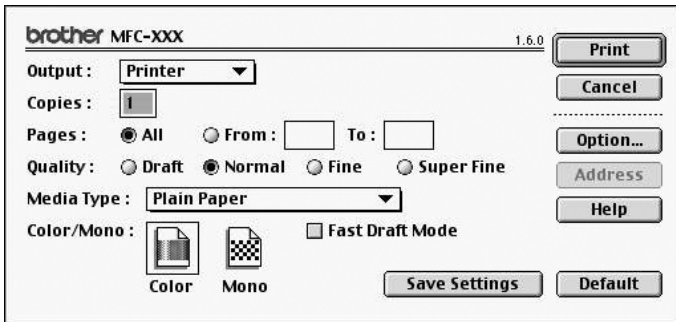

When **Printer** is selected, the top button shows **Print** and the **Address** button is grayed.

- 3 From the **Output** pull-down menu, select **Facsimile**.

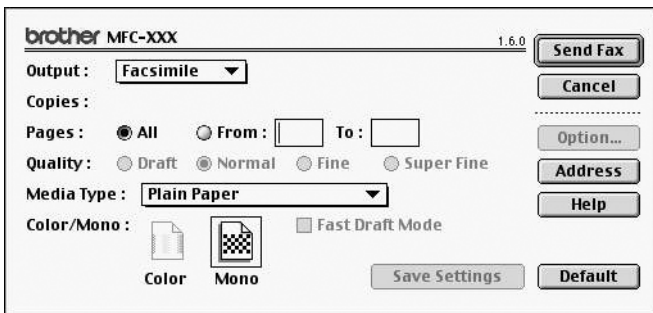

When **Facsimile** is selected, the top button shows **Send Fax** and the **Address** button is available.

4 Click **Send Fax**.

The Send Fax dialog box appears:

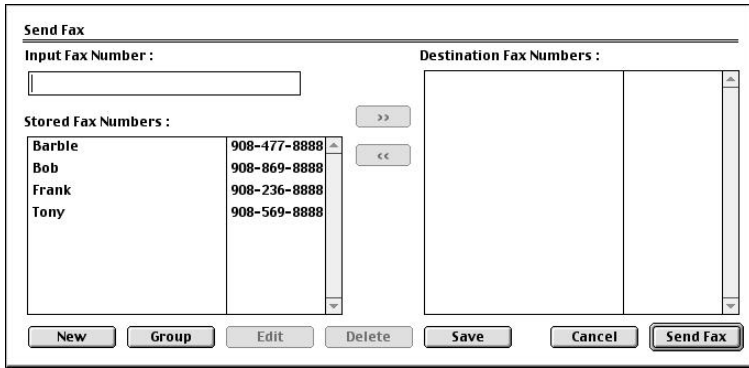

The Send Fax dialog box has two list boxes. The left box shows all the previously **Stored Fax Numbers**; the right box will show the **Destination Fax Numbers** as you select them.

5 To address the fax, type a fax number in the **Input Fax Number** box.

—OR—

Select a name/number from the **Stored Fax Numbers** box, and then click . Your recipient will appear in the **Destination Fax Numbers** box.



You can select several stored numbers at once by using the Shift and Ctrl keys.

6 If you want to, you can add your new recipients to the Stored Fax Number at this time by clicking **New**. (See *Adding a New Member*, page 17-5.)

—OR—

You can add a new group by clicking **Group**. (See *Adding a New Group*, page 17-6.)

7 If you are finished addressing your fax, click **Send Fax**.



To select and send only certain pages of the document, click **OK** to return to the Print dialog box.



If you click **Send Fax** without addressing your fax, the following error message appears:

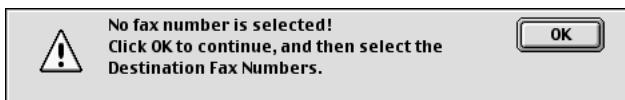

Click **OK** to return to the Send Fax dialog box.

Setting Up Your Address Book

You can add new members and groups to your Address Book, even while you are addressing a fax.

Adding a New Member

- 1 To add a new member to the Address Book, in the Facsimile dialog box click **Address**.

The Address Book dialog box appears:

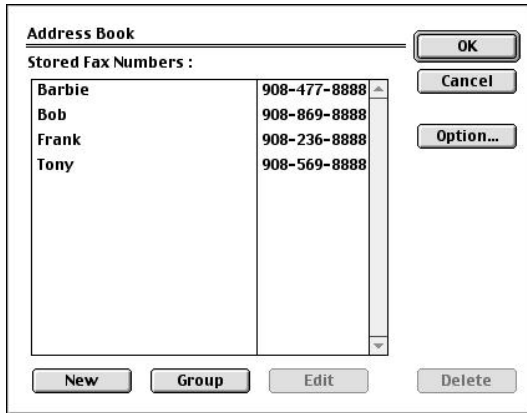

- 2 Click **New**. The following dialog box appears:

Form fields: Name, Fax#, Memo

Buttons: OK, Cancel

- 3 Type the name and fax number.
- 4 If you want to, you can store a comment in the Memo field if you wish (up to 15 characters).
- 5 Click **OK** to return to the Address Book dialog box.

Adding a New Group

You can set up a group of multiple recipients.

1 Click **Group**.

The Group Setting dialog box appears.

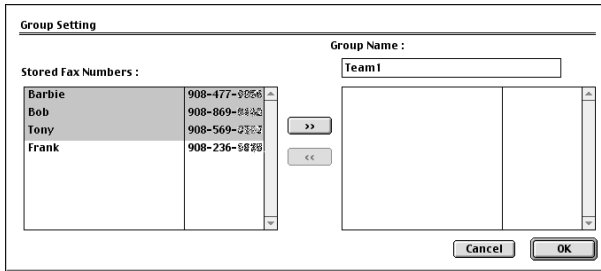

2 In the *Group Name* field, type a name for your Group.

3 From the **Stored Fax Numbers** box select the recipients for your Group, and then click **>>**.

Your selection will appear in the box under the **Group Name** field.

4 Click **OK**.

The Address Book dialog box reappears:

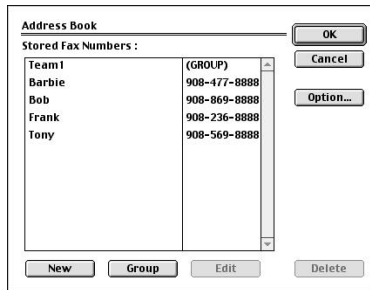

5 Click **OK**.

The Print/Facsimile dialog box reappears:

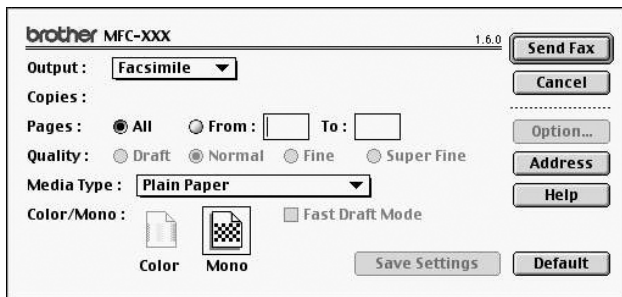

6 If you are ready to send your fax, click **Send Fax**.
(Follow the steps on page 17-3 for sending a fax.)

Using Brother TWAIN Scanner Driver with Your Apple® Macintosh®

The Brother MFC software includes a TWAIN Scanner driver for Macintosh®. This Macintosh® TWAIN Scanner driver can be used with application that supports the TWAIN specification. You can use PaperPort® for scanning.

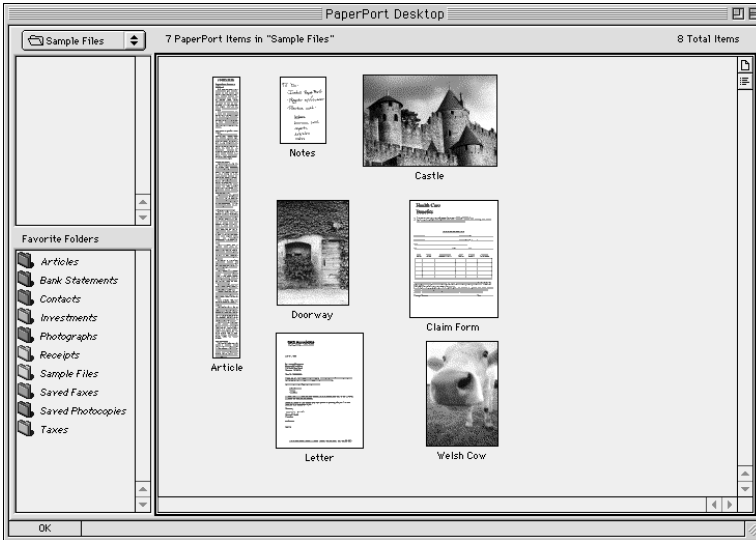

Accessing the Scanner

Run your PaperPort® software. You will see the **PaperPort® icon** in the upper right hand corner of your screen. The first time you use the Brother TWAIN driver, set it as the default by choosing the *Select Source*, then click the **PaperPort® icon**. Afterward, for each original you scan choose **Acquire Image** by clicking the **PaperPort® icon**. The Scanner setup dialog box will appear.

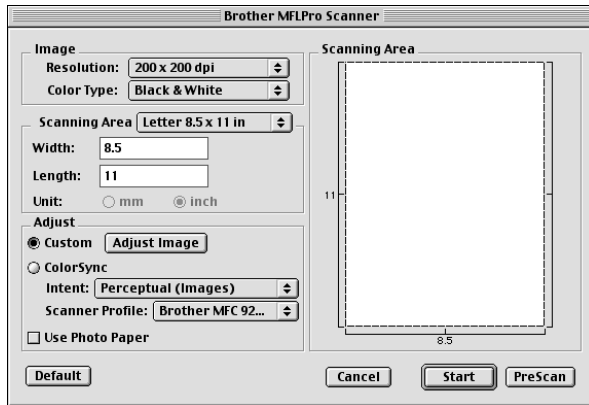

Scanning an Image into Your Macintosh G3, G4 or iMac

- 1 Place the original in the ADF.
- 2 Adjust the following settings, if needed, in the scanner setup dialog box:
 - Resolution*
 - Color Type*
 - Brightness*
 - Contrast*
 - Scanning Area*

- 3 Click **Start**.

When scanning is finished, the image will appear in your graphics application.

Settings in the Scanner Window

Image

Resolution

Choose the scanning resolution from the Resolution pop-up menu. Higher resolutions take more memory and transfer time, but can achieve a finer scanned image. (Each model has different resolutions. See Specification.)

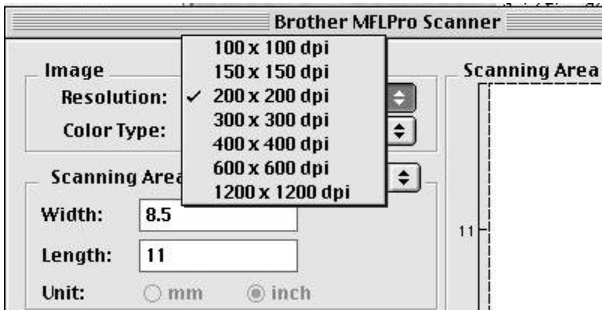

Color Type

Black & White—Set the image Type to Black&White for text or line art. For photographic images, set the image type to Gray (Error diffusion) or True Gray.

Gray (Error Diffusion)—is used for documents that contain photographic images or graphics. (Error Diffusion is a method for creating simulated gray images by placing black dots in a specific matrix instead of true gray dots.)

True Gray—also is used for documents containing photographic images or graphics. This mode is more exact because it uses up to 256 shades of gray. It requires the most memory and longest transfer time.

Colors—Choose either 256 Color, which scans up to 256 colors, 24-bit color which scans up to 16.8 million colors. Although using 24-bit color creates an image with the most accurate colors, the image file will be approximately three times larger than a file created with 256 Color.

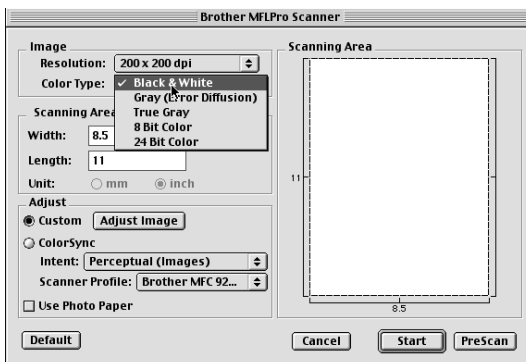

Scanning Area

Set the **Size** to one of the following:

- *Letter* (8.5 × 11 inches)
- *A4* (210 × 297 mm)
- *Legal* (8.5 × 14 inches)
- *A5* (148 × 210 mm)
- *B5* (182 × 257 mm)
- *Executive* (7.25 × 10.5 inches)
- *Business Card* (90 × 60 mm)
- *Custom* (User adjustable from 0.35 × 0.35 inches to 8.5 × 14 inches)

After you choose a custom size, you can adjust the scanning area. Click and hold the mouse button as you drag the mouse to crop the image.

Width: Enter the width of the custom size.

Length: Enter the length of the custom size.

Business Card Size

To scan business cards, select the Business Card size setting (90 × 60 mm) and place the business card at the top center of a carrier sheet.



Carrier sheets are available from your Dealer.

When scanning photographs or other images for use in a word processor or other graphics application, it is a good idea to try different settings for the contrast, mode and resolution to determine which settings look best.

Adjust Image

Brightness

Adjust the brightness settings to obtain the best image. The Brother TWAIN Scanner driver offers 100 brightness settings (-50 to 50). The default value is 0, representing an “average” setting.

You can set the Brightness level by dragging the slider to the right to lighten the image or to the left to darken the image. You can also type a value in the box to set the setting. Click **OK**.

If the scanned image is too light, set a lower Brightness value and scan the document again.

If the image is too dark, set a higher Brightness value and scan the document again.

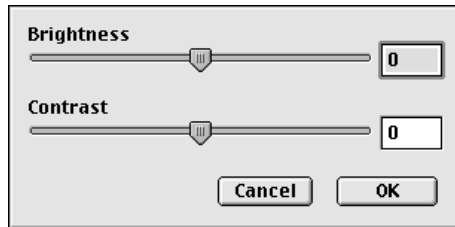

Contrast

The Contrast setting is adjustable only when you have selected one of the gray scale settings, but it is not available when Black & White is selected as the Gray Scale.

Increasing the Contrast level (by dragging the slider to the right) emphasizes dark and light areas of the image, while decreasing the Contrast level (by dragging the slider to the left) reveals more detail in gray areas. Instead of using the slider, you can type a value in the box to set the Contrast. Click **OK**.

Color Sync Dialog

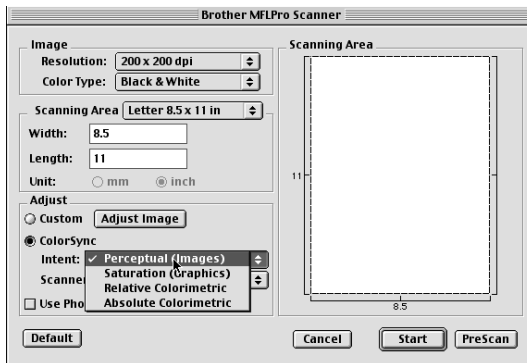

Perceptual Matching—All the colors of a given gamut are scaled proportionally to fit within another gamut. This intent pretty much maintain the balance between the colors in the image. This intent is the best choice for realistic images, such as scanned photographs.

Saturation Matching—The relative saturation of colors is maintained from gamut to gamut. So basically the colors are shifted to the edge of the gamut to get the most saturated color possible. Rendering the image using this intent gives the strongest colors and is the best choice for bar graphs and pie charts, in which the actual color displayed is less important than its vividness.

Relative Colorimetric Matching—The colors that fall within the gamuts of both devices are left unchanged. Some colors in both images will be exactly the same, a useful outcome when colors must match quantitatively. What that means is that if the color is inside the gamut, it will stay the same color. However, if the color is outside the gamut, it will be mapped to the edge of the gamut. This intent is best suited for logos or “spot colors” where color must match.

Absolute Colorimetric Matching—A close appearance match may be achieved over most of the tonal range, but if the minimum density of the idealized image is different from that of the output image, the areas of the image that are left blank will be different. Colors that fall within the gamuts of both devices are left unchanged.

Scanner Profile

Select your Brother MFC.

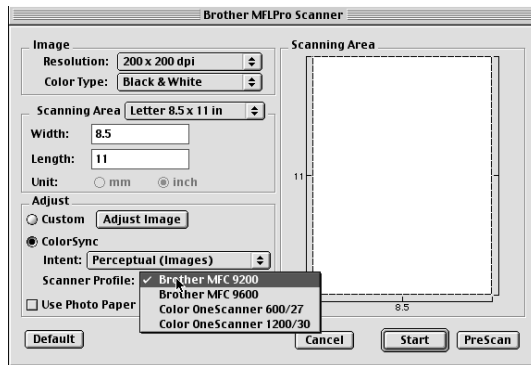

PreScanning an Image

PreScanning allows you to scan an image quickly at a low resolution. A thumbnail version will appear in the Scanning Area. This is only a preview of the image, so you can see how it will look. The PreScan button is used to preview an image for any unwanted portions. When you are satisfied with the preview, click **Start** to scan the image.

- 1 Insert the original face up in the ADF, or face down on the scanner glass.
- 2 Click **PreScan**.
The entire original will be scanned into your Macintosh G3 or iMac and will appear in the Scanning Area of the Scanner dialog box:
- 3 To scan a portion of the prescanned image, click and drag the mouse to crop it.

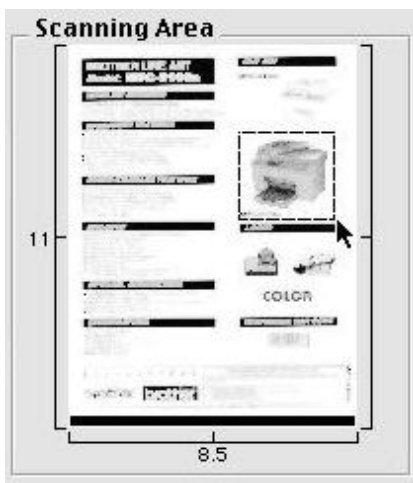

- 4 Insert the original face up in the ADF, or face down on the scanner glass again.
- 5 Adjust the settings for Resolution, Color Type (Gray Scale), Brightness, Contrast, and Size in the Scanner Setup dialog box, as needed.
- 6 Click **Start**.
This time only the selected area of the original will appear in the Scanning Area.
- 7 In your editing software application, refine the image as usual.

18 Important Information

Standard Telephone and FCC Notices

These notices are in effect on models sold and used in the United States only.

When programming emergency numbers and/or making test calls to emergency numbers:

- Remain on the line and briefly explain to the dispatcher the reason for the call before hanging up.
- Perform these activities in the off-peak hours, such as early morning or late evening.

This equipment complies with Part 68 of FCC Rules. On the rear panel of this equipment is a label that contains, among other information, the FCC Registration Number and Ringer Equivalence Number (REN) for this equipment. You must, upon request, provide this information to your telephone company.

You may safely connect this equipment to the telephone line by means of a standard modular jack, USOC RJ11C.

An FCC compliant telephone cord with a modular plug is provided with this equipment. This equipment is designed to be connected to the telephone line or premises wiring using a compatible modular jack that is Part 68 compliant. See the Installation section of this manual for details.

The REN is useful to determine the quantity of devices you may connect to your telephone line and still have those devices ring when your telephone number is called. In most, but not all areas, the sum of the RENs of all devices connected to one line should not exceed five (5). To be certain of the number of devices you may connect to your line, as determined by the REN, you should contact your local telephone company to determine the maximum REN for your calling area. If your MFC-5100C damages the telephone line, the telephone company may discontinue your service temporarily. If possible, they will notify you in advance. But if advanced notice is not practical, you will be notified as soon as possible. You will be informed of your right to file a complaint with the FCC.

Your telephone company may make changes to its facilities, equipment, operations or procedures that could affect the proper functioning of your equipment. If they do, you will be notified in advance to give you an opportunity to maintain uninterrupted telephone service.

If you experience trouble with your MFC-5100C, please contact a Brother Authorized Service Center for information on obtaining service or repair. The telephone company may ask that you disconnect this equipment from the line until the problem has been corrected or until you are sure that the equipment is not malfunctioning.

If you are not able to solve a problem with your MFC, contact Brother Customer Service. (See *Brother Numbers*, page i.)

WARNING

For protection against the risk of electrical shock, always disconnect all cables from the wall outlet before servicing, modifying or installing the equipment.

This equipment may not be used on coin service lines provided by the telephone company or connected to party lines.

Brother cannot accept any financial or other responsibilities that may be the result of your use of this information, including direct, special or consequential damages. There are no warranties extended or granted by this document.

WARNING

Important—About the Interface Cable

This machine has been certified to comply with FCC standards, which are applied to the USA only. The filter core supplied with your MFC should be attached to the shielded interface cable according to FCC 15,27 (a). In addition, a grounded plug should be plugged into a grounded AC outlet after checking the rating of the local power supply for the printer to operate properly and safely.

Federal Communications Commission (FCC) Declaration of Conformity (For USA Only)

Responsible Party:	Brother International Corporation 100 Somerset Corporate Boulevard Bridgewater, NJ 08807-0911 USA TEL: (908) 704-1700
--------------------	--

declares, that the products

Product Name: MFC-5100C

comply with Part 15 of the FCC Rules. Operation is subject to the following two conditions: (1) This device may not cause harmful interference, and (2) this device must accept any interference received, including interference that may cause undesired operation.

This equipment has been tested and found to comply with the limits for a Class B digital device, pursuant to Part 15 of the FCC Rules. These limits are designed to provide reasonable protection against harmful interference in a residential installation. This equipment generates, uses, and can radiate radio frequency energy and, if not installed and used in accordance with the instructions, may cause harmful interference to radio communications. However, there is no guarantee that interference will not occur in a particular installation. If this equipment does cause harmful interference to radio or television reception, which can be determined by turning the equipment off and on, the user is encouraged to try to correct the interference by one or more of the following measures:

- Reorient or relocate the receiving antenna.
- Increase the separation between the equipment and receiver.
- Connect the equipment into an outlet on a circuit different from that to which the receiver is connected.
- Consult the dealer or an experienced radio/TV technician for help.

Important

Changes or modifications not expressly approved by Brother Industries, Ltd. could void the user's authority to operate the equipment.

Industry Canada Compliance Statement (For Canada Only)

This Class B digital apparatus complies with Canadian ICES-003.

Cet appareil numérique de la classe B est conforme à la norme NMB-003 du Canada.

International ENERGY STAR® Compliance Statement

As an ENERGY STAR® Partner, Brother Industries, Ltd. has determined that product meets the ENERGY STAR® guidelines for energy efficiency.



Important Safety Instructions

- 1 Read all of these instructions.
- 2 Save them for later reference.
- 3 Follow all warnings and instructions marked on the product.
- 4 Unplug this product from the wall outlet before cleaning. Do not use liquid or aerosol cleaners. Use a damp cloth for cleaning.
- 5 Do not use this product near water.
- 6 Do not place this product on an unstable cart, stand, or table. The product may fall, causing serious damage to the product.
- 7 Slots and openings in the cabinet and the back or bottom are provided for ventilation; to ensure reliable operation of the product and to protect it from overheating, these openings must not be blocked or covered. The openings should never be blocked by placing the product on a bed, sofa, rug, or other similar surface. This product should never be placed near or over a radiator or heater. This product should never be placed in a built-in installation unless proper ventilation is provided.
- 8 This product should be operated from the type of power source indicated on the label. If you are not sure of the type of power available, consult your dealer or local power company.
- 9 This product is equipped with a 3-wire grounding type plug, a plug having a third (grounding) pin. This plug will fit into only a grounding-type power outlet. This is a safety feature. If you are unable to insert the plug into the outlet, contact your electrician to replace your obsolete outlet. Do not defeat the purpose of the grounding-type plug.
- 10 Do not allow anything to rest on the power cord. Do not place this product where people can walk on the cord.
- 11 If an extension cord is used with this product, make sure that the total ampere ratings on the products plugged into the extension cord do not exceed the extension cord ampere rating. Also, make sure that the total of all products plugged into the wall outlet does not exceed 15 amperes (USA only).
- 12 Do not place anything in front of the machine that will block received faxes. Do not place anything in the path of received faxes.
- 13 Wait until pages have exited the machine before picking them up.
- 14 Never push objects of any kind into this product through cabinet slots, since they may touch dangerous voltage points or short out parts resulting in the risk of fire or electric shock. Never spill liquid of any kind on the product.
- 15 Do not attempt to service this product yourself, as opening or removing covers may expose you to dangerous voltage points and/or other risks, and may void your warranty. Refer all servicing to Authorized Service Personnel. A list of Authorized Service Centers has been included for your convenience, or you may contact Customer Service for your nearest Brother Authorized Service Center. (See *Brother Numbers*, page i.)
- 16 This product does not have an ON/OFF switch. Therefore, it is very important that you have easy access to the main plug and the main socket to which the plug is connected, in case the main power to the MFC must be disconnected quickly.
- 17 Unplug this product from the wall outlet and refer servicing to Authorized Service Personnel under the following conditions:
 - A When the power cord is damaged or frayed.
 - B If liquid has been spilled into the product.
 - C If the product has been exposed to rain or water.
 - D If the product does not operate normally when the operating instructions are followed. Adjust only those controls that are covered by the operating instructions. Improper adjustment of other controls may result in damage and will often require extensive work by a qualified technician to restore the product to normal operation.
 - E If the product has been dropped or the cabinet has been damaged.
 - F If the product exhibits a distinct change in performance, indicating a need for service.
- 18 To protect your product against power surges, we recommend the use of a power protection device (Surge Protector).

Trademarks

The Brother logo is a registered trademark of Brother Industries, Ltd.

Brother is a registered trademark of Brother Industries, Ltd.

Multi-Function Link is a registered trademark of Brother Industries, Ltd.

© Copyright 2000 Brother Industries, Ltd. All rights reserved.

Windows and Windows NT, Microsoft, MS-DOS, Excel and Word are registered trademarks of Microsoft in the U.S. and other countries.

Macintosh and QuickDraw are a registered trademarks and iMac and iBook are trademarks of Apple Computer, Inc.

PaperPort and TextBridge are registered trademarks of ScanSoft, Inc.

IBM, IBM PC and Proprinter are registered trademarks of International Business Machines Corporation.

Hammermill and JetPrint PHOTO are a registered trademark of International Paper.

Each company whose software title is mentioned in this manual has a Software License Agreement specific to its proprietary programs.

All other brand and product names mentioned in this manual are registered trademarks of their respective companies.

19 Troubleshooting and Routine Maintenance

Troubleshooting

IMPORTANT

For technical and operational assistance, you must call the country where you purchased the MFC. Calls must be made *from within* that country.

Error Messages

As with any sophisticated office product, errors may sometimes occur. If this happens, your MFC often identifies the problem and displays an error message. The table below explains the most common error messages.

You can correct most problems by yourself. If you need additional help, call the Brother fax-back system.

In USA: 1-800-521-2846

Or, visit us at: <http://solutions.brother.com>

ERROR MESSAGES

ERROR MESSAGE	CAUSE	ACTION
CHECK CARTRIDGE	An ink cartridge is not installed properly.	Re-install the ink, seating it properly. See page 19-16.
CHECK ORIGINAL	Original was not inserted or fed properly, or document scanned from ADF was longer than about 40 inches (90cm).	See page 19-3.
CHECK PAPER SIZE	You paper is not correct size.	Reload the correct paper, and then press Black Fax Start .
CHECK PAPER	MFC is out of paper.	Add paper, and then press Black Fax Start .
COMM. ERROR	Poor phone line quality caused communication error.	Try the call again. If problem continues, call the telephone company to check your phone line.
CONNECTION FAIL	You tried to poll a fax machine that is not in Polled Waiting mode.	Verify the other party's polling setup.
COVER OPEN	The scanner cover is not closed completely.	Pull the Scanner Cover Release Button and lift the top cover, then close it.
DISCONNECTED	The other party or other party's fax machine terminated the call.	Try to transmit or receive again.
HIGH TEMPERATURE	The print head detects high temperature.	Use the MFC at the cool room or cool your room.

ERROR MESSAGES

ERROR MESSAGE	CAUSE	ACTION
INK EMPTY	<p>One or more of the ink cartridges are empty. The MFC will stop all print operations (such as printing copies, faxes and jobs from the PC). While memory is available, black and white faxes will be received into memory. If a sending machine has a color fax, the MFC's "handshake" will request that the fax be sent as black and white; if the sending machine has the feature to convert it, the color fax will be received into memory as a black and white fax. MFCs connected with a USB cable will be able to perform scan operations; MFCs connected with a parallel cable, will not scan.</p> <p>To preserve good quality, the MFC periodically cleans the print head. Also, you can press Ink to start the cleaning when needed. This cleaning process uses up ink and can cause the ink to run out.</p>	Replace the ink cartridges. See page. 19-16.
LOW TEMPERATURE	The print head detects low temperature.	Use the MFC at the warm room or warm your room.
MACHINE ERROR XX	MFC has a mechanical problem.	<p>Call Brother Customer Service.</p> <p>In USA: 1-800-284-4329</p> <p>In Canada: 1-877-BROTHER</p> <p>In Montreal: 1-514-685-6464</p>
NEAR EMPTY	<p>One or more of the ink cartridges are running out of ink. The MFC will stop receiving color faxes. The MFC's "handshake" will request that it be sent in black and white; if the sending machine has the feature to convert it, the color fax will be received into memory as a black and white fax.</p>	Order a new ink cartridge. See page. ii.
NO RESPONSE/ BUSY	The number you dialed does not answer or is busy.	Verify the number and try again.
NOT REGISTERED	You tried to access a Speed Dial number that is not programmed.	Set up the Speed Dial number. See page 7-1.
OUT OF MEMORY	The data is too large for the MFC's memory.	See page 10-2.
PAPER JAM	The paper is jammed in the MFC.	See page 19-3.
DOC. COVER OPEN	The document cover is open.	Remove any paper from the ADF and close the document cover.

Original Jams and Paper Jams

Based upon where the original or printed sheet is jammed, follow the appropriate set of instructions to remove it.

Original is Jammed in the top of the ADF Unit

- 1 Remove any paper from the ADF that is not jammed.
- 2 Lift the ADF cover
- 3 Pull the jammed original out to the right.
- 4 Close the ADF cover.
- 5 Press **Stop/Exit**.

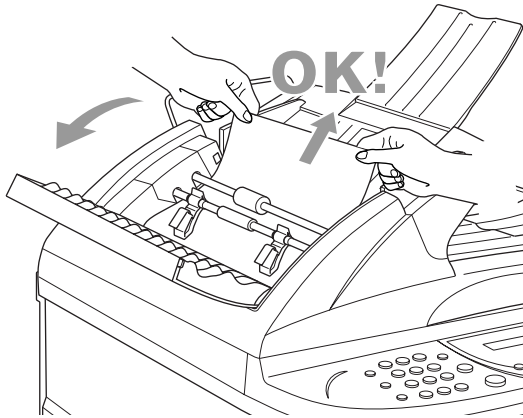

Original is Jammed inside the ADF Unit

- 1 Remove any paper from the ADF that is not jammed.
- 2 Lift the document cover.
- 3 Pull the jammed original out to the right.
- 4 Close the document cover.
- 5 Press **Stop/Exit**.

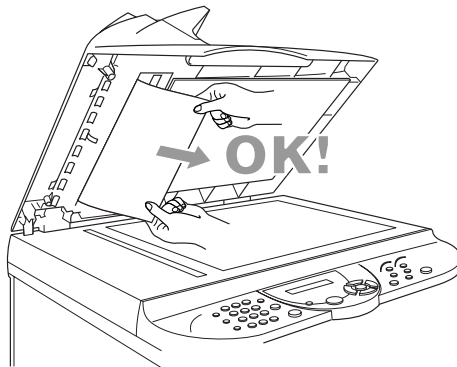

Printer Jam or Paper Jam

Remove the jammed paper depending on where it is jammed in the MFC.

Paper is jammed in the multi-purpose sheet feeder.

- 1 Remove any paper from the multi-purpose sheet feeder that is not jammed.
- 2 Pull up the jammed paper to remove it.

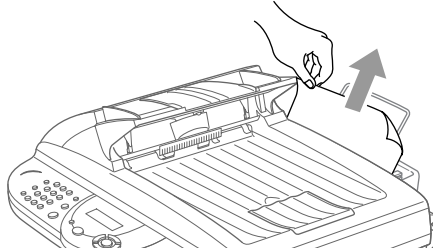

Note If you have difficulty removing the jammed paper, press and hold the Paper Release Lever as you pull out the page.

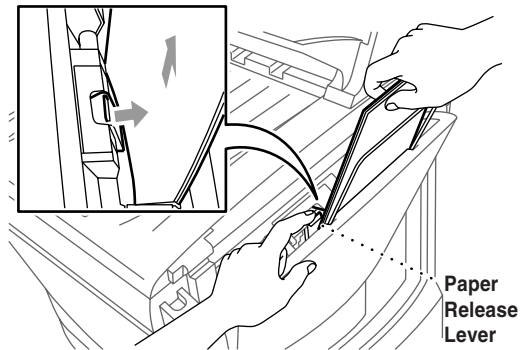

Note To improve the reliability of paper feeding, turn on Secure Feed mode by pressing the **Ink** and **Scan to** keys simultaneously. The MFC will then feed paper more securely, but paper feeding will take a longer time. To turn off the Secure Feed mode, simultaneously press **Ink** and **Scan to** again.

Note If **PAPER JAM** occurs frequently, install the Card Stock Support in the feeder and reload the paper. Or, try reloading the paper upsidedown.

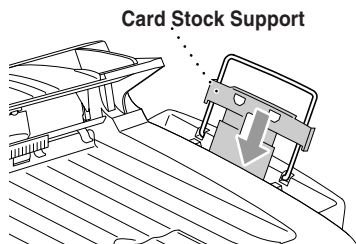

Paper is jammed inside the MFC.

1 Open the Scanner Cover by releasing the Scanner Cover release lever and lifting the Scanner Cover.

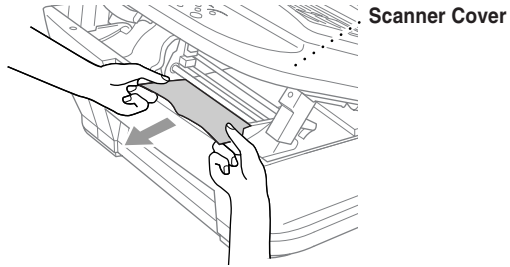

2 Remove the jammed paper.

Note If the jammed paper is under the Print Head, unplug the MFC, and then you can move the Print Head to remove the paper.

3 Close the Scanner Cover.

Paper is jammed inside the front of the MFC.

Pull the paper toward you.

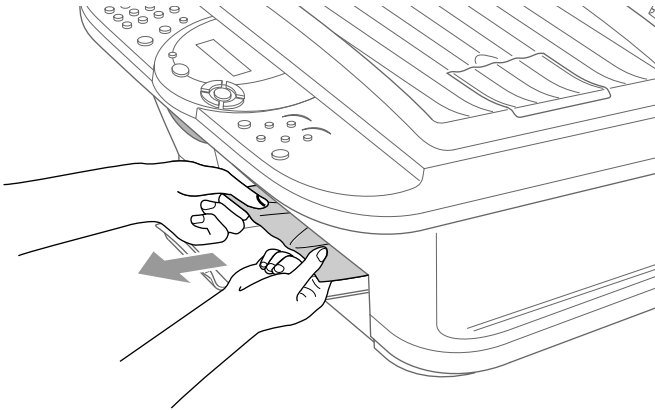

Paper is jammed inside the back of the MFC.

If the paper rips, the pieces of paper may get stuck inside the back of the machine.

- 1** Remove any paper from the multi-purpose sheet feeder that is not jammed.
- 2** Open the paper jam cover.
- 3** To loosen the paper, slide the paper width guide to the widest position.

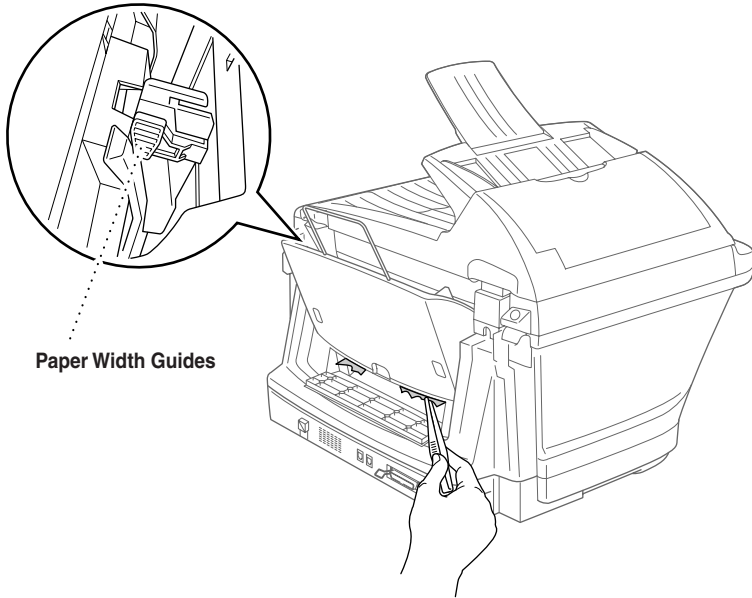

- 4** Use tweezers to pull out the ripped pieces of paper.
- 5** Close the paper jam cover.

If You Are Having Difficulty with Your MFC

If you think there is a problem with your MFC, *make a copy first*. If the copy looks good, the problem is probably not your MFC. Check the chart below and follow the troubleshooting tips.

If you have any other problems, visit us at: <http://solutions.brother.com>

DIFFICULTY	SUGGESTIONS
Printing or Receiving Faxes	
Condensed Print and Horizontal Streaks / Top and Bottom of Sentences Are Cut Off	If your copy looks good, you probably had a bad connection, with static or interference on the phone line. If the copy looks bad, call Brother Customer Service at 1-800-284-4329 (in USA), 1-877-BROTHER (in Canada) or 1-514-685-6464 (in Montreal).
Poor Quality Print	Make sure the Printer Driver matches the type of paper you are using (see page 12-2). If you are using plain paper, try using recommended special paper (see Chapter 2). Don't handle the paper until the ink is dry. Adjust the Vertical Alignment (See <i>Print Quality Check</i> , page 19-10).
Smudged stain on the top center of the printer page	Change Paper Thickness to Thick in the Paper tab of the Print dialog box, in the Printer Driver setting.
Printing Too Dark or Too Light	Make sure your ink cartridges are fresh. Cartridges are good up to two years, after that the ink may become clogged. Cartridge expiration dates are printed on the package. Make sure the Printer Driver matches the type of paper you are using (see page 12-2). Try using recommended special paper (see Chapter 2). The recommended environment for your MFC is between 68°F to 91°F.
Printing Appears Dirty or Ink Seems to Run	Make sure you are using the recommended paper (see Chapter 2). Don't handle the paper until the ink is dry. The recommended environment for your MFC is between 68°F to 91°F.
White Lines in Text or Graphics	Clean the print head (See <i>Cleaning the Print Heads</i> , page 19-9).
Stains Appear on the Reverse Side or at the Bottom of the Page	Make sure the Printer Platen and Pick Up Roller are not dirty with ink mist. (See page 19-16).
Vertical Black Lines When Receiving	The sender's scanner may be dirty. Ask the sender to make a copy to see if the problem is with the sending machine. Try receiving from another fax machine. If the problem continues, call Brother Customer Service at 1-800-284-4329 (in USA), 1-877-BROTHER (in Canada) or 1-514-685-6464 (in Montreal).
Received color fax prints only in B & W.	Replace the color ink cartridges that are empty or nearly empty, and then ask the other party to send the color fax again. (See <i>Replacing the Ink Cartridges</i> , page 19-16.)
Left and Right margins are cut off	Turn on Auto Reduction. (See <i>Printing a Reduced Incoming Fax (Auto Reduction)</i> , page 5-3.)
Phone Line or Connections	
MFC Does Not Answer When Called	Make sure the MFC is in the correct receiving mode for your setup (either MANUAL , FAX ONLY , or EXT. TEL/TAD). Check for dial tone. If possible, call your MFC to hear it answer. If there is still no answer, check the telephone line cord connection. If there is no ringing when you call your MFC, call your telephone company to check the line.
Sending Faxes	
Poor Transmitting Quality	Try changing your resolution to FINE or S.FINE . Make a copy to verify your MFC's scanner operation.

DIFFICULTY	SUGGESTIONS
Transmission Verification Report says “Result:NG”	There is probably temporary noise or static on the line. Try sending the fax again. If you send a PC FAX message and get “Result:NG” on the Transmission Verification Report, your MFC may be out of memory. To gain extra memory, you can turn off Fax Storage (See page 8-2), print fax message in memory (See page 5-4) or cancel a delayed fax or polling job (See page 5-6). If the problem continues, call the telephone company to check your phone line.
Vertical Black Lines When Sending	If the copy you made shows the same problem, your scanner is dirty (See <i>Cleaning the Scanner</i> , page 19-15).
Handling Incoming Calls	
MFC “Hears” Voice as CNG Tone	If your MFC is set to Easy Receive ON, it is more sensitive to sounds. Your MFC may mistakenly interpret certain voices or music on the line as a calling fax machine and respond with fax receiving tones. Deactivate the fax by pressing Stop/Exit . Try avoiding this problem by turning Easy Receive to OFF. (See <i>Easy Receive</i> , page 5-3.)
Transferring a Fax Call to the MFC	If you answered at the MFC, press Black Fax Start and hang up immediately. If you answered at an extension phone, press your Fax Receive Code (default setting is *51). When your MFC answers, hang up.
Custom Features on a Single Line	If you have Call Waiting, Caller ID, Call Waiting/Caller ID, Ring Master, Voice Mail, an alarm system or any other custom feature on a single phone line with your MFC, it may create a problem sending or receiving fax data. For example: If you are sending or receiving a fax message while a custom feature signal comes through on the line, the signal can temporarily interrupt or disrupt the fax data. Brother’s ECM feature should help overcome this problem. This condition is related to the telephone system industry and is common to all devices that send and receive information on a single, shared line with custom features. If avoiding a slight interruption is crucial to your business, a separate line with no custom features is recommended.
Printer Difficulties	
Horizontal lines appear in Text or Graphics.	Clean the print head (See <i>Cleaning the Print Heads</i> , page 19-9). If you clean the print heads five times and the print has not improved, call Brother Customer Service at 1-800-284-4329 (in USA), 1-877-BROTHER (in Canada) or 1-514-685-6464 (in Montreal).
Scanning Difficulties	
TWAIN Errors appear while scanning	Make sure the Brother TWAIN Driver is selected as the primary source. In PaperPort®, click File Select Source, highlight the Brother TWAIN Driver and click Select.
Software Difficulties	
Cannot perform ‘2 in 1’ printing.	Check that the paper size setting in the application and in the printer driver are the same.
Cannot print when using Paint Brush.	Try setting the Display setting to ‘256 colors.’
Cannot print when using Adobe Illustrator.	Try to reduce the printing resolution.
Thick line and thin line appear alternately. (banding)	Turn OFF ‘Bi-Directional Printing’ from the ‘Quality/Color’ tab in the printer driver.
There are some dense lines.	Turn ON ‘Reverse Order’ from the ‘Paper’ tab in the printer driver.
When using ATM fonts, some characters are missing or some characters are printed in the same place.	If you are using Windows® 95 or 98, select ‘Printer Settings’ from the ‘Start’ menu. Open ‘Brother XXXX’ properties. Click ‘Spool Setting’ on the ‘Details’ tab. Select ‘RAW’ from ‘Spool Data Format.’

DIFFICULTY	SUGGESTIONS
Printing is slow.	In the Quality/Color tab of the Print dialog box, select Auto in the Document section.
True2Life is not working correctly.	If the image data is not full color (such as 256 color) in your application, True2Life does not function. Please use at least 24 bit color data with the True2Life feature.
“Unable to write to LPT1” or “LPT1 already in use” Error Message appears.	1. Make sure the MFC is on (plugged into the AC outlet) and that it is connected directly to the computer using the IEEE-1284 bi-directional parallel cable. The cable must not go through another peripheral device (such as a Zip Drive, External CD-ROM Drive, or Switch box). 2. Make sure the MFC is not displaying an error message on the LCD. 3. Make sure no other device drivers, which also communicate through the parallel port, are running automatically when you boot up the computer (such as, drivers for Zip Drivers, External CD-ROM Drive, etc.). Suggested areas to check: (Load=, Run=command lines in the win.ini file or the Startup Group). 4. Check with your computer manufacturer to confirm that the computer’s parallel port settings in the BIOS are set to support a bi-directional machine, i.e., Parallel Port Mode-ECP
“MFC is Busy” or “MFC Connect Failure” Error Message appears.	
“MFC Connect Failure”	If the MFC is not connected to your PC and you have loaded the Brother software, the PC will show “MFC Connect Failure” each time you restart Windows®. You can ignore this message or you can turn it off by deselect the AutoLoad PopUp check box in the Brother Control Center chapter. (See <i>How to Turn Off AutoLoad</i> , page 13-2.)

How to Improve Print Quality

Cleaning the Print Heads

Clean the print head if you get a horizontal line in the text or graphics on your printed pages. There are two print heads; each contains two print cartridges. You can clean either black and cyan, yellow and magenta or all four colors by pressing **Ink**.

Caution

Do NOT clean the print head by touching it with your hand or a cloth.

- 1 Press **Ink**.
- 2 Press **1** to choose **1.CLEANING**.
- 3 Press  to choose the color you want to clean, and then press **Menu/Set**.

The MFC will clean the print head automatically. When cleaning is finished, the MFC will go back online automatically.



If you clean the print head at least five times and the print has not improved, call Brother Customer Service for assistance at 1-800-284-4329 (**in USA**), 1-800-853-6660 (**in Canada**), or 1-514-685-6464 (**in Montreal**).

Print Quality Check

If the print quality is not satisfactory, you can print a Print Quality Check Sheet to help you identify settings you may need to change.

- 1 Press **Menu/Set, 4**.

4. TEST PRINT

- 2 Press **Black Fax Start**.

The MFC begins printing the Print Quality Check Sheet.

The LCD shows:

IS STEP "A" OK?

1. YES 2. NO

- 3 Check the sheet to see if the quality and alignment are OK by following STEPS A and B.

STEP A: Color Block Quality Check

The LCD shows:

IS STEP "A" OK?

1. YES 2. NO

Check the quality of the four color blocks in the sheet. (BLACK/CYAN/YELLOW/MAGENTA).

If the quality is OK for all colors, press **1 (YES)** to go to **STEP B—OR—**

If white horizontal lines appear in some color blocks below, press **2 (NO)**.

OK



Poor



The LCD will ask you if the print quality is OK for each color.

BLACK OK?

1. YES 2. NO

Press **2 (NO)** for any color with a problem.

The LCD shows:

START CLEANING?

1. YES 2. NO

Press **1 (YES)**, the MFC will start cleaning the colors.

After cleaning is finished, press **Black Fax Start**. The MFC will start printing the Print Quality Check Sheet again and then return to **STEP A**. If **STEP A** is OK, press **1** to proceed to **STEP B**.

STEP B: Alignment Check

The LCD shows:

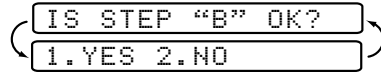

Check the 600 DPI and 1200 DPI test prints to see if number 5 most closely matches number 0. If the number 5 sample of both the 600 DPI and 1200 DPI are the best matches, press **1 (YES)** to finish **STEP B—OR—** If another test print number is a better match for either 600 DPI or 1200 DPI, press **2 (NO)** to select it.

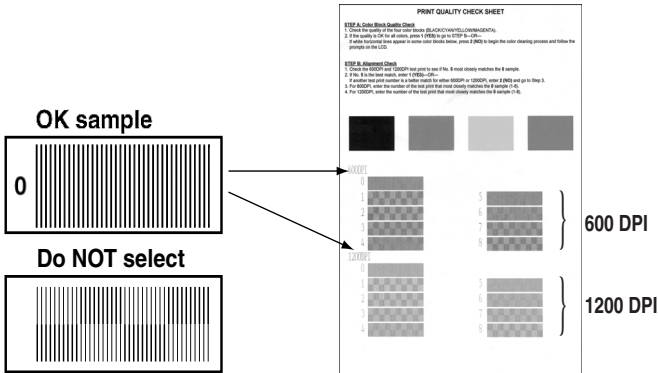

For 600 DPI, press the number of the test print that most closely matches the number 0 sample (1-8).

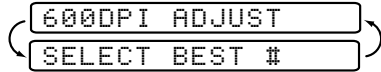

For 1200 DPI, press the number of the test print that most closely matches the number 0 sample (1-8).

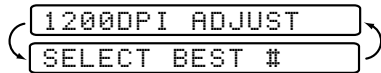

- 4 Repeat Steps 1 and 2 (in *Print Quality Check*) to print another sample Print Quality Check Sheet and then check it.
- 5 Press **Stop/Exit**.



When an ink head nozzle is clogged the printed sample looks like this.



After the ink head nozzle is cleaned, the horizontal lines are gone.

If you still see missing ink in this Print Quality Check Sheet, repeat the cleaning and test print procedures at least five times. If ink is still missing after the fifth cleaning and test print, replace the ink cartridge for the clogged color. (Perhaps the ink cartridge was in your MFC over six months or the expiration date written on the cartridge package has passed. Or, the ink may not have been stored properly before use.)

After replacing the ink cartridge, check it by printing another Print Quality Check Sheet. If the problem still exists, repeat the cleaning and test print procedures at least five times for the new ink cartridge. If ink is still missing, call Customer Service at 1-800-284-4329 (in USA), 1-877-BROTHER (in Canada) or 1-514-685-6464 (in Montreal).

! Caution

Do NOT touch the print head. Touching the print head may cause permanent damage and may void the print head's warranty.

Packing and Shipping the MFC

Whenever you transport the MFC, use the packing materials that came with your MFC. If you do not pack the MFC correctly, you could void your warranty.

! Caution

- Do NOT unplug the MFC after a print job until you hear the final click.

- 1 Remove all the ink cartridges and attach the white shipping cover. (See *Replacing the Ink Cartridges*, page 19-16.)

To attach the white shipping cover

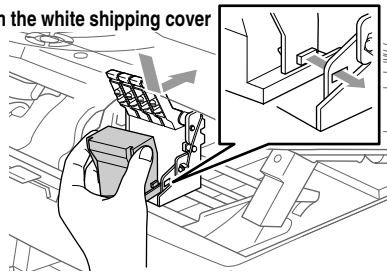

- 2 Attach the protective yellow bar.

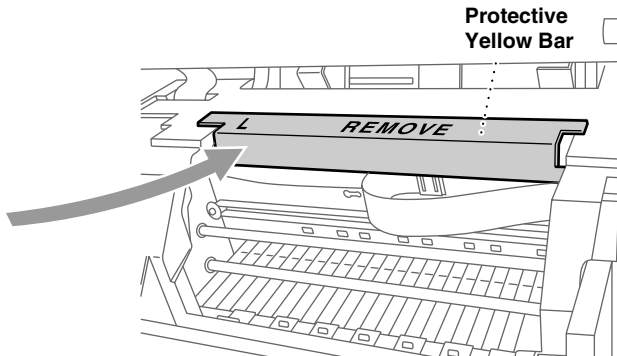

- 3 Unplug the MFC from the telephone wall socket.
- 4 Unplug the MFC from the AC outlet.
- 5 Unplug the Parallel cable or USB cable from the MFC.
- 6 Remove the telephone line cord, and place them in original packing materials or protective wrapping.
- 7 Wrap the MFC in the plastic bag.

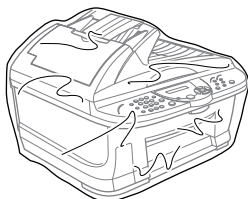

- 8 Place the MFC in the original carton with the original packing material.

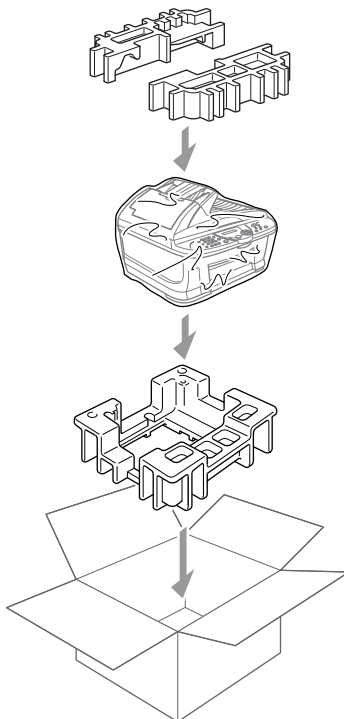

- 9** Pack additional parts (cord and printed materials) in the carton.
DO NOT pack the used ink cartridges.

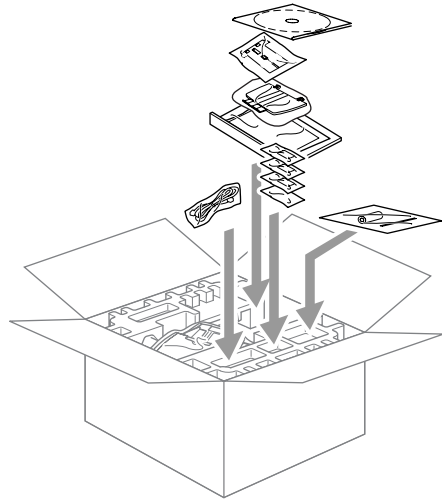

Note If you are returning the MFC to Brother as part of the Brother Exchange Service, pack only the MFC. Keep all separate parts to use with your “Exchange” machine.

- 10** Close the carton.

Routine Maintenance

Cleaning the Scanner

Unplug the MFC and lift the document cover. Clean the scanner glass and the white film with isopropyl alcohol on a lint-free cloth.

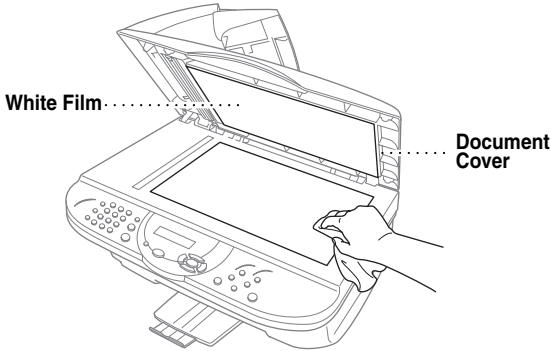

Open the ADF cover. Clean the white bar and the glass strip under the bar with isopropyl alcohol on a lint-free cloth.

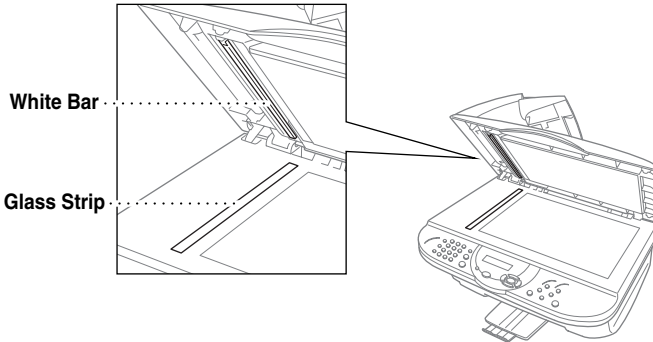

Cleaning the MFC Printer Platen



WARNING

- Be careful not to touch the paper feed star wheels and flat cable, and encode film.
- Be sure to unplug the MFC from the AC power outlet before cleaning the printer platen.

To clean your MFC printer platen, wipe it with a lint free cloth that is *dry*.

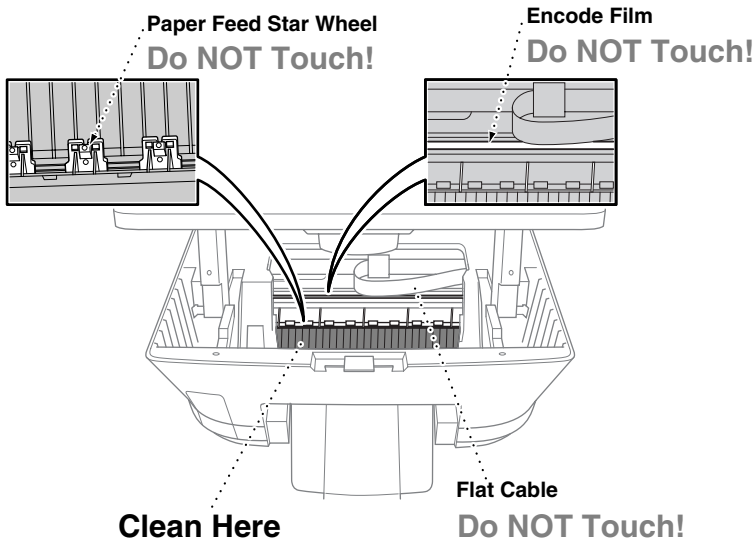

Replacing the Ink Cartridges

Your MFC is equipped with an ink dot counter that automatically monitors the ink level in each color cartridge. When the counter detects an ink cartridge is running out of ink, the MFC will notify you with a message on the LCD.

The LCD shows you which color cartridges are low or empty. Be sure to follow the LCD prompts so you replace the color cartridges in the appropriate order.

When the ink cartridges are running low, you must use Ink to begin the cartridge replacement (Steps 1 to 3). If the ink is empty, skip to Step 4.

- 1** Press **Ink**.
- 2** Press **2** to choose **2. REPLACE INK**.
If one or more ink cartridges are empty, for example Black, the LCD shows **INK EMPTY BLACK** and **PLS OPEN COVER**.
- 3** Pull the Scanner cover release lever and lift the Scanner cover.

- 4 Press the appropriate colored ink cartridge cover to open it, and then remove the ink cartridge.

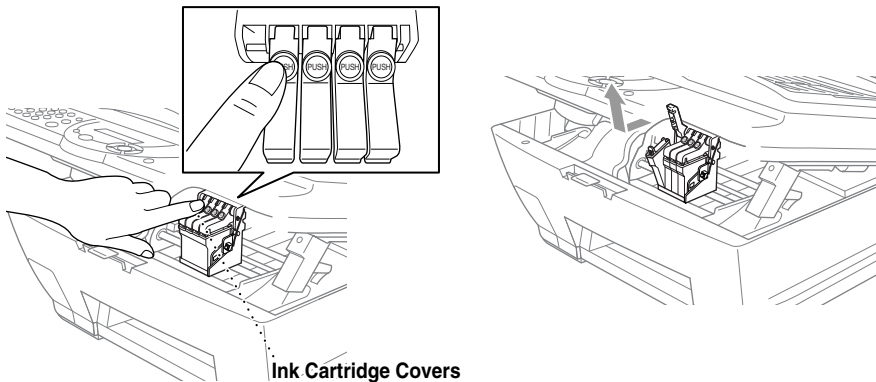

- 5 Open the new ink cartridge bag for the color shown on the LCD, and then take out the ink cartridge.

- 6 Hold the new ink cartridge as shown in the illustration, and then peel the sealing tape from the side of the ink cartridge. Carefully peel the tape in the direction away from you.



Note To prevent spilling ink and staining your hands and clothing, remove the sealing tape gently.

- 7 Each color has its own correct position. Insert the new ink cartridge into its carriage, and then close the ink cartridge cover by pressing until it clicks.
- 8 After installing the ink cartridges, close the Scanner cover. Your MFC prepares for a “head cleaning” and goes online. The LCD prompts you to verify a new ink cartridge was inserted for each color you removed. Example: **DID YOU CHANGE BLCK? 1. YES 2. NO.**
If the ink cartridge you installed is not a brand new one, please make sure to select 2.
- 9 For each new cartridge, press **1** on the dial pad to reset the ink dot counter for that color automatically.

The MFC will enter a cleaning cycle for approximately 3 minutes for each replaced cartridge. The LCD alternately shows **CLEANING** and **PLEASE WAIT**.

When the MFC completes the cleaning cycle, the LCD returns to Standby mode (date and time).



WARNING

If ink gets in your eyes, irrigate them with water immediately and consult a doctor if you are concerned.



Caution

- DO NOT remove ink cartridges if you do not need to replace them. If you do so, it may reduce the ink quantity and the printer will not know the quantity of ink left in the cartridge.
- DO NOT shake the ink cartridges, because the ink may spill when you take off the sealing tape.
- If ink stains your body or clothing, wash with soap or detergent immediately.
- If you install an ink cartridge in the wrong color position, you must clean the print head several times before you start printing (after correcting the cartridge installation) because the colors were mixed.
- Once you open an ink cartridge, install it in the MFC and use it up within six months of installation. Use unopened ink cartridges by the expiration date written on the cartridge package.
- DO NOT refill the ink cartridges. Attempting to use refilled cartridges and using incompatible inks may cause damage to the print head in this machine and such damage will not be covered by warranty. Warranty coverage does not apply to problems caused by the use of 3rd party ink or 3rd party ink cartridges. Use only genuine Brother ink cartridges.



If the **INK EMPTY** message is on the display after you have installed ink cartridges, check that the ink cartridges are installed correctly.

If you still cannot solve a problem with your MFC, call Brother Customer Service (See *Brother Numbers*, page i).

Fax (Continued)

Memory Capacity	4 MB (up to 200 pages*)
Speed Dial	40 stations
Automatic Redial	3 times at 5 minute intervals
Auto Answer	0, 1, 2, 3, 4 or 5 rings
Communication Source	Public switched telephone network
Operating Environment	50–95° F (10–35° C)
Best Print Quality	68–91° F (20–33° C)
Power Source	120V AC 50/60Hz (USA, Canadian Version Only)
Power Consumption	Standby: under 13.5 watts Operating: under 40.0 watts
Dimensions	18.4 × 18.4 × 14.5 (inches) 468 × 467 × 368 (mm)
Weight	24.3 lb/11 kg

* “Pages” refers to the “Brother Standard Chart No. 1” (a typical business letter, Standard resolution, MMR code). Specifications and printed materials are subject to change without prior notice.

Printer

Printing

Print Method	Piezo with 75 × 4 nozzles
Resolution	2400 × 1200 dots per inch (DPI) 1200 × 1200 dots per inch (DPI) 600 × 600 dots per inch (DPI) 600 × 300 dots per inch (DPI) 600 × 150 dots per inch (DPI)
Print Speed	up to 10 pages/minute (Mono) up to 8 pages/minute (Color)
Print Width	8 inches (203.2 mm)
Disk-Based Fonts	35

Controller

Parallel Interface

A bi-directional shielded parallel that is IEEE 1284 compliant and no longer than 6 feet (1.8m). You must attach the bundled filter core and filter tie.

USB Interface

A Standard Universal Serial Bus cable that is no longer than 6 feet (1.8m).



To meet FCC emission requirements for the MFC, you must attach the bundled filter core and cable tie to the Parallel cable.

Computer Requirements

Minimum System Requirements					
Computer Platform & Operating System Version		Processor Minimum Speed	Minimum RAM	Recommended RAM	Available Hard Disk Space
Windows® Operating Systems	95, 98, 98SE	Pentium 75MHz	24MB	32MB	50MB
	Me	Pentium 150MHz	32MB	64MB	
	NT® Workstation 4.0	Pentium 75MHz			
	2000 Professional	Pentium 133MHz	64MB	128MB	
	XP	Pentium 233MHz			
Apple iMac™/iBook™/G3/G4 Operating Systems	OS 8.5 – 8.51 (Printing Only)	All base models meet minimum requirements			50MB
	OS 8.6 – 9.2 (Printing and Scanning)				
	Mac OS X v.10/10.1 (Printing Only)†				
<p>NOTE: USB is not supported under Windows® 95 or Windows NT® 4.0 All registered trademarks referenced herein are the property of their respective companies. † Printer Driver can be downloaded from http://solutions.brother.com</p>					

Print Media

Paper Input

Automatic loading from the Multi-Purpose Sheet Feeder

- Paper type:
Plain paper, inkjet paper (coated paper), glossy paper, transparencies and envelopes
- Paper size:
Letter, Legal, A4, A5, B5, Executive, envelopes (commercial No. 10, DL, C5), Postcard, Index card.
 - Width 3.5–8.5" (89–216 mm)
 - Length 5.0–14" (127–356 mm)
 - Weight 17–32 lb (64–120 g/m²)
 - Thickness 0.003–0.006" (0.08–0.15 mm)
 - envelopes: up to 0.02" (0.52 mm)
 - postcard: up to 0.009" (0.23 mm)
 - index card: up to 0.006" (0.15 mm)
- Maximum feeder capacity: Approx. 100 sheets of 20 lb (75 g/m²) plain paper.

Paper Output

Approximately 50 sheets of plain paper (Face up print delivery to the paper output tray)

To prevent smearing the ink, we recommend removing printed pages from the paper output tray immediately after they exit the machine.

Consumable Items

Ink

Black and 3 individual color ink cartridges separate from the two print heads.

Service Life of Ink Cartridge

Approximately 950 page/Black cartridge at 5% coverage with 600 × 150dpi resolution (Draft).

Approximately 450 page/Color cartridge at 5% coverage with 600 × 150dpi resolution (Draft).



These numbers are based on consecutive printing; the numbers will vary based on print frequency and number of pages.

The MFC periodically cleans the print head to maintain print quality. This process consumes a small amount of ink.

Glossary

- ADF (Automatic Document Feeder)** Refers to the number of pages that can be placed in the document feeder and fed one at a time automatically.
- Auto Dial List** A listing of names and numbers stored in Speed Dial memory, in numerical order.
- Automatic E-Mail Printing** Software application that automatically prints incoming e-mail messages on the MFC (on the CD-ROM).
- automatic fax transmission** Sending a fax without picking up the handset of an external or extension phone.
- Automatic Redial** A feature that enables your MFC to redial the last fax number if the original fax did not go through because the line was busy.
- Backup Print** Sets your MFC to print a copy of every fax that is received and stored in memory. This is a safety feature so you will not lose message during a power failure.
- beeper** The sound the keys make when they are pressed, an error occurs or a document has been received or transmitted.
- beeper volume** Volume setting for the beep when you press a key or make an error.
- Brightness** Changing the Brightness makes the whole image lighter or darker.
- Broadcasting** The ability to send the same fax message to more than one location.
- Cancel Job** Cancels a programmed job, like Delayed Fax or Polling.
- CNG tones** The special tones (beeps) sent by fax machines during automatic transmission to tell the receiving machine that they are a from fax machine.
- communication error (or Comm. Error)** An error during fax sending or receiving, usually caused by line noise or static.
- Coding Method** Method of coding the information contained in a document. All fax machines must use a minimum standard of Modified Huffman (MH). Your fax machine is capable of greater compression methods, Modified Read (MR) and Modified Modified Read (MMR), if the receiving machine has the same capability.
- Compatibility Group** The ability of one fax unit to communicate with another. Compatibility is assured between ITU-T Groups.
- Contrast** Setting to compensate for dark or light documents, by lightening dark documents or darkening light documents.
- Delayed Fax** Sends your fax at a later time that day.
- Distinctive Ring** A service purchased from the Telephone Company that provides another phone number on an existing phone line. The Brother MFC uses the new number to simulate a dedicated fax line.
- Dual Access** Your MFC can scan outgoing faxes or scheduled jobs into memory at the same time it is sending a fax or receiving or printing an incoming fax.

- Easy Receive** Enables your MFC to respond to CNG tones if you interrupt a fax call by answering it.
- ECM (Error Correction Mode)** Detects errors during fax transmission and resends the page(s) of the document that had an error.
- E-Mail Printing** Software application that automatically retrieves your e-mail messages from your POP3 server and prints them on your MFC.
- extension phone** A telephone on the fax number that is plugged into a separate wall jack.
- external phone** A TAD (telephone answering device) or telephone that is plugged into the EXT jack of your MFC.
- Fax Activity Report** Lists information about the last 200 incoming and outgoing faxes. TX means Transmit. RX means Receive.
- Fax Forwarding** Sends a fax received in memory to another preprogrammed fax number.
- Fax Storage** You can print stored faxes later, or retrieve them from another location using Fax Forwarding, Paging, or Remote Retrieval functions.
- fax tones** The signals sent by sending and receiving fax machines while communicating information.
- Fine Mode** Resolution is 196 × 203 dpi. It is used for small print and graphs.
- gray scale** The shades of gray available for copying and faxing photographs.
- group number** A combination of Speed Dial numbers that are stored on a Speed Dial for Broadcasting.
- Ink button** Cleans the print head and/or resets the ink dot counter after replacing an ink cartridge.
- interval** The preprogrammed time period between automatically printed Activity Reports. You can print Activity Reports on demand without interrupting this cycle.
- LCD (liquid crystal display)** The display screen on the MFC that shows interactive messages during On-Screen Programming and defaults to the date and time when the machine is idle.
- manual fax** When you lift the handset of your external telephone so you can hear the receiving fax machine answer before you press Start to begin transmission.
- Multi-Function Link Pro® Suite** Turns your MFC into a printer and a scanner and enables PC faxing using the MFC.
- Next Fax Reservation** Dual Access accepts the next original in the ADF for transmission while the Memory is full.
- OCR (optical character recognition)** The bundled ScanSoft™ TextBridge® software application converts an image of text to text you can edit.
- Out of Paper Reception** Receives faxes into the MFC's memory when the machine is out of paper.
- Overseas Mode** Makes temporary changes to the fax tones to accommodate noise and static on overseas phone lines.
- Paging** Feature enables your fax unit to call your pager when a fax is received into its memory.
- Pause** Allows you to place a 3.5 second delay in the dialing sequence stored on Speed Dial numbers.

- Photo mode** A resolution setting that uses varying shades of gray for the best representation of photographs.
- Polling** The process of a fax machine calling another fax machine to retrieve waiting fax messages.
- printer alarm** Audible alarm when the printer is not able to print.
- Pulse (For Canada Only)** A form of rotary dialing on a telephone line.
- Real Time Transmission** When memory is full, you can send documents in real time.
- Reduction** Reduces the size of incoming faxes.
- remaining jobs** You can check which jobs are waiting in memory and cancel jobs individually.
- Remote Activation** Allows you to transfer a fax call, answered at an external or extension phone, to the MFC.
- Remote Retrieval Access** The ability to access your MFC remotely from a touch tone phone.
- Remote Retrieval Access Code** The four-digit code (159✕) that allows you to call and access your MFC from a remote location.
- Resolution** The number of vertical and horizontal lines per inch. See: Standard, Super Fine and Photo.
- Ring Delay** The number of rings before the MFC answers in FAX mode.
- Ring Volume** Volume setting for the MFC's ring.
- scanning** The process of sending an electronic image of an original paper document into your computer.
- ScanSoft™ PaperPort® for Brother** Document management application where you can view received faxes and scanned image.
- speed dial** A preprogrammed number for easy dialing. You must press the **Search/Speed Dial** button and then #, two digit code to start the dialing process.
- Standard resolution** 98 × 203 dpi. It is used for regular size text and quickest transmission.
- Station ID** The stored information that appears on the top of faxed pages. It includes the sender's name and fax number.
- Super fine resolution** 392 × 203 dpi. Best for very small print and line art.
- TAD (telephone answering device)** You can connect an *external* TAD to the EXT. jack of the MFC for EXT. TEL/TAD mode.
- Temporary Settings** You can select certain options for each fax transmission without changing the default settings.
- transmission** The process of sending documents over the phone lines from your MFC to the receiving fax machine.
- Transmission Verification Report** A listing of each transmission, that shows its date, time and number.
- True 2 Life** Adjusts the color in the image for better print quality by improving sharpness, white balance and color density.
- User Settings** A printed report that shows the current settings of your MFC.

Index

A

- access codes, storing and dialing 7-4
- accessories and supplies ii
- ADF (Automatic Document Feeder) 6-1
- ADF cover 19-3
- alternating displays 3-1
- assembly 2-6
 - extension 2-8
 - grounded 3-prong plug 2-7
 - ink cartridges, installing 2-10
 - loading paper 2-9
 - paper tray 2-8
 - paper wire extension 2-8
- automatic
 - dialing 7-4
 - fax receive 5-1
 - fax redial 6-5
 - transmission 6-5

B

- Broadcasting 7-5
 - setting up Groups for 7-3
- Brother
 - accessories and supplies ii
 - Brother numbers i
 - Customer Service i
 - fax-back system i
 - Frequently Asked Questions (FAQs) i
 - product support i
 - test sheet, sending 1-2
 - Warranties iii, iv, vi
- Brother Control Center
 - using and configuring 13-1 to 13-15

C

- canceling
 - fax forwarding 8-4
 - fax jobs in memory 5-6
 - jobs awaiting redial 6-7
 - paging 8-4
 - scheduled job 5-6
- cleaning
 - cycle 2-12
 - print head 19-9
 - printer platen 19-16
 - scanner 19-15
- CNG tones 1-5
- connecting 2-1
 - external TAD 2-13
 - external telephone 2-13
- control panel, overview 1-3
- copy
 - brightness 10-6
 - color adjustment 10-10
 - contrast 10-10
 - default settings 10-9
 - enlarging 10-3
 - keys 10-3
 - multiple 10-1
 - paper 10-6
 - quality 10-4, 10-9
 - reducing 10-3
 - scanner glass 10-2
 - single 10-1
 - sorting 10-7
 - temporary settings 10-3
- Credit Card Numbers 7-4
- custom telephone features 2-18, 19-8

D

- Date and Time 4-2
- Delayed Batch Transmission 6-8
- Delayed Fax 6-8
- dialing
 - a pause 7-6
 - access codes and credit card numbers 7-4
 - automatic fax redial 6-5
 - Fax Redial 7-6
 - Groups 7-5
 - Search 7-4
 - Speed Dial numbers 7-4
- drivers
 - Macintosh 17-1
 - printer 12-1
 - TWAIN Compliant 14-4
- Dual Access 6-5

E

- Easy Receive 5-3
- ECM (Error Correction Mode) 1-6
- entering text 4-3
- envelopes 2-4, 2-5
- error messages on LCD 19-1
 - BLCK 1. YES 2. NO 19-17
 - CHECK PAPER 19-1
 - CLEANING 19-18
 - CLEANING BLACK 2-12
 - COMM. ERROR 19-1
 - DID YOU CHANGE 19-17
 - INK EMPTY 19-2
 - MEMORY FULL 19-2
 - NOT REGISTERED 19-2
 - OUT OF MEMORY
 - while scanning a document 6-6, 10-2
- extension telephone, using 5-4
- external telephone 2-13

F

- fax codes
 - Fax Receive Code 5-4
 - Remote Retrieval Access Code 8-3
 - Telephone Answer Code 5-4
 - troubleshooting 5-4
- Fax Forwarding 8-1
 - changing remotely 8-4, 8-5
 - programming a number 8-1
- Fax Receive Code 5-3, 5-4
- Fax Storage 8-2
 - printing from 5-4
 - turning on 8-2
- fax, stand-alone
 - receiving 5-1
 - difficulty 19-7
 - erasing from the memory 8-4
 - forwarding 8-1, 8-4
 - polling 5-5
 - reducing to fit on paper 5-3
 - retrieving from a remote site 8-5
 - ring delay, setting 5-2
 - sending
 - automatic transmission 6-5
 - canceling from memory 6-7
 - color fax 6-5
 - contrast 6-4
 - delayed 6-8
 - from memory (dual access) 6-5
 - manual transmission 6-5
 - overseas 6-7
 - polling 6-9
 - Real Time Transmission 6-6
 - resolution 6-4
- FCC notices 18-1

G

- gray scale S-1
- Groups for Broadcasting 7-3

H

- HELP 3-1, 9-2

I

- ink cartridges 2-1, 2-11, 2-12
 - Ink Dot Counter 2-12
 - Ink Management 1-3
- installing 2-10
- replacing 19-16

J

- jacks 2-15, 2-16
 - convert to RJ11 jack 2-16
 - EXT. jack
 - external telephone 2-13
 - TAD (answering machine) 2-13
 - triplex adapter 2-16
- jams
 - original 19-3
 - paper 19-3

L

- LCD (Liquid Crystal Display) 1-3, 3-1

M

- Macintosh® G3, G4 or iMac™ or iBook™ 17-1
- maintenance, routine 19-15
- manual
 - receive 5-1
 - transmission 6-5
- Memory Storage 4-5
- Menu mode 3-1
 - programming at-a-glance 3-1
- multi-line connections (PBX) 2-17
- multi-purpose sheet feeder 2-8
 - loading paper 2-9

O

- Options key (copying) 10-5
 - Brightness 10-5
 - Paper Size 10-5
 - Paper Type 10-5
 - sorting 10-5
 - Special Copy Options 10-5

P

- packing list 2-1
- Paging 8-1, 8-2
 - programming your pager number 8-1
- Paper 2-3
 - capacity 2-4
 - jam 19-3
 - loading 2-9
 - Size 4-1
 - size of original 6-1
 - Specifications 2-4
 - Type 4-1
- PaperPort
 - accessing 14-5
 - exporting 14-4
 - importing 14-4
 - uninstall 14-1
- PC FAX (For Windows®) 15-3
 - sending
 - address book 15-7
 - cover page 15-13
 - facsimile style 15-14
 - group 15-9
 - setting up 15-3
 - simple style 15-16
- phone line
 - connections 2-14
 - difficulties 19-7
 - multi-line (PBX) 2-17
 - roll-over lines 2-15
 - two-line phone system 2-15
- Polling
 - receiving 5-5
 - sending 6-9
 - sequential receiving 5-5
- power 2-2, 2-7
 - cord 2-7
 - electrical outlet 2-7
 - failure 4-5
- print
 - area 2-5
 - difficulty 19-7
 - fax from memory 5-4

Improving quality 19-9
jams 19-4
resolution S-2
size 2-4
specifications S-2

Q

Quality key (copying) 10-3, 10-4

R

Receive mode
EXT.TEL/TAD 5-1
FAX ONLY 5-1
MANUAL 5-1
Redial/Pause 1-3, 6-5
reducing
copies 10-3
long faxes 5-3
Remote Retrieval 8-1
access code 8-2, 8-3
changing settings 8-3
commands 8-4
getting your faxes 8-5
Reports 9-1
Transmission Verification 9-2
resolution
fax (standard, Fine, SuperFine, Photo)
S-1
print S-2
Scan 14-6
setting for next fax 6-4
Ring Delay, setting 5-2

S

Safety Instructions 18-4
Scanner Cover Release Lever 2-10
Scanning into PC 14-5
ScanSoft™ PaperPort® 14-1
Scansoft™ TextBridge® OCR 14-3
Search, for stored numbers 7-4
Setup
Date and Time 4-2
Station ID (fax header) 4-2
shipping the machine 19-12
software
Brother Control Center 13-1
ScanSoft™ Paper Port® 14-1
Speed Dial 1-3
changing 7-2
dialing 7-4
storing 7-1

T

TAD (Telephone Answering Device) 1-6,
2-14, 2-16, 2-17, 5-1
TAD (Telephone Answering Device),
external
connecting 2-13
receive mode 5-1
Temporary Copy Settings 10-3
text, entering 4-3 to 4-4
Special Characters 4-3
Tone Signals on Pulse Line 7-6
troubleshooting 19-1
error messages on LCD 19-1
if you are having difficulty 19-7
incoming Calls 19-8
phone line difficulty 19-7
printer difficulties 19-8
printing or receiving faxes 19-7
sending faxes 19-7
two-line phone system 2-15, 2-16, 2-17

V

Volume, setting
 beeper 4-5
 ring 4-4

W

Warranties iii
 Canada vi
 Notice-Disclaimer iii
 USA iv
World Wide Web i

Remote Retrieval Access Card

If you plan to receive fax messages while away from your machine, carrying the Remote Retrieval Access Card printed below will serve as a convenient reminder of the retrieval procedures. Simply cut out the card and fold it to fit your wallet or organizer. Keeping it handy will help you derive the full benefit of your machine's forwarding, paging and remote retrieval features.

REMOTE RETRIEVAL ACCESS CARD

CHECK RECEIVING STATUS
Press **9 7 1**
1 long beep — Fax message(s)
3 short beeps — No messages

CHANGE ANSWER MODE
Press **9 8**
then for EXT. TEL/TAD, press **1**.
FAX, press **2**.

EXIT REMOTE OPERATION
Press **9 0**.

Using Remote Retrieval Access Code

- 1** Dial your fax number from a fax machine using touch tone.
- 2** When your MFC answers, immediately enter your Remote Retrieval Access Code (159✳).
- 3** Your MFC signals the kinds of messages received:
1 long beep — Fax message(s)
No beeps — No messages.
- 4** After 2 short beeps, enter a command.
- 5** Press **9 0** to reset your MFC when you finish.
- 6** Hang up.

1

4

Fold →

← Fold

Changing Remote Retrieval Access Code

- 1 Press **Menu/Set 2, 5, 3**.
- 2 Enter a three-digit number from 000 to 999.
The * cannot be changed.
- 3 Press **Menu/Set**.
- 4 Press **Stop/Exit**.

Remote Commands

CHANGE PAGING/FAX FORWARDING SETTING

- Press **95**.
then to Turn feature off, press **1**.
Select Fax Forwarding, press **2**.
Select Paging, press **3**.

Program Fax Forwarding Number, press **4**. Enter the new fax number where you want your fax messages forwarded followed by **##**.

- Turn Fax Storage on, press **6**.
Turn Fax Storage off, press **7**.

RETRIEVE A FAX

- Press **96**.
then to Retrieve all faxes, press **2**.
then enter the number of remote fax machine, and then press **##**. After the beep, hang up and wait.
Erase all fax messages, press **3**.

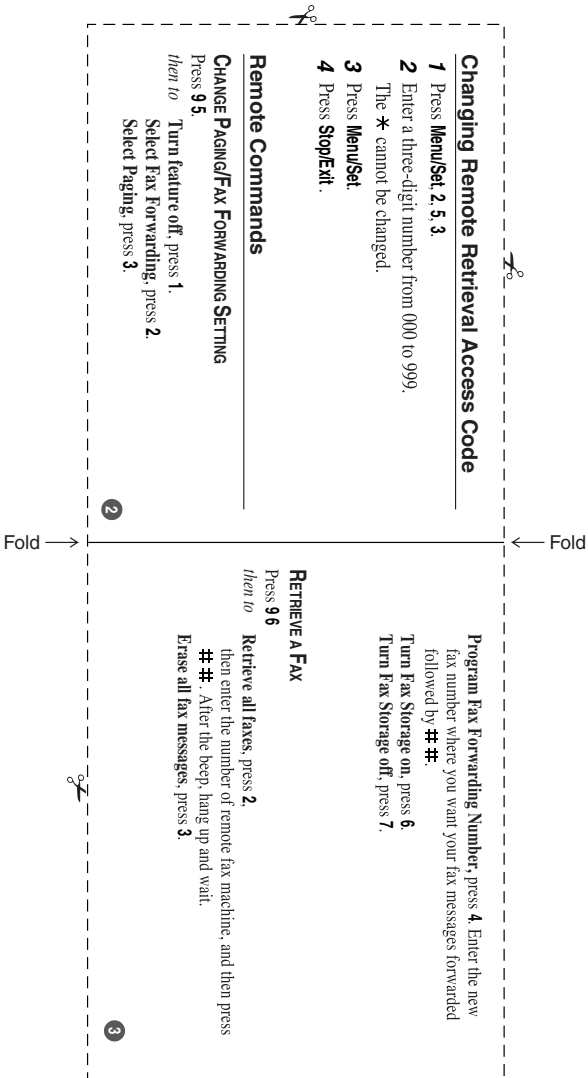

EQUIPMENT ATTACHMENT LIMITATIONS (For Canada Only)

NOTICE:

The industry Canada label identifies certified equipment. This certification means that the equipment meets telecommunications network protective, operational and safety requirements as prescribed in the appropriate Terminal Equipment Technical Requirements document(s). The Department does not guarantee the equipment will operate to the user's satisfaction.

Before installing this equipment, users should ensure that it is permissible to be connected to the facilities of the local telecommunications company. The equipment must also be installed using an acceptable method of connection. The customer should be aware that compliance with the above conditions may not prevent degradation of service in some situations.

Repairs to certified equipment should be coordinated by a representative designated by the supplier. Any repairs or alterations made by the user to this equipment, or equipment malfunctions, may give the telecommunications company cause to request the user to disconnect the equipment.

Users should ensure for their own protection that the electrical ground connections of the power utility, telephone lines and internal metallic water pipe system, if present, are connected together. This precaution may be particularly important in rural areas.

Caution:

Users should not attempt to make such connections themselves, but should contact the appropriate electric inspection authority, or electrician, as appropriate.

NOTICE:

The Ringer Equivalence Number (REN) assigned to each terminal device provides an indication of the maximum number of terminals allowed to be connected to a telephone interface. The termination on an interface may consist of any combination of devices subject only to the requirement that the sum of the Ringer Equivalence Numbers of all the devices does not exceed 5 REN=0.3

brother®

Brother International Corporation
100 Somerset Corporate Boulevard
P.O. Box 6911
Bridgewater, NJ 08807-0911 USA

Brother International Corporation (Canada) Ltd.
1 rue Hôtel de Ville,
Dollard-des-Ormeaux, QC, CANADA H9B 3H6

**Visit us on the World Wide Web
<http://www.brother.com>**

These machines are made for use in the USA and CANADA only. We cannot recommend using them overseas because it may violate the Telecommunications Regulations of that country and the power requirements of your multi-function center may not be compatible with the power available in foreign countries. **Using USA or CANADA models overseas is at your own risk and will void your warranty.**

Free Manuals Download Website

<http://myh66.com>

<http://usermanuals.us>

<http://www.somanuals.com>

<http://www.4manuals.cc>

<http://www.manual-lib.com>

<http://www.404manual.com>

<http://www.luxmanual.com>

<http://aubethermostatmanual.com>

Golf course search by state

<http://golfingnear.com>

Email search by domain

<http://emailbydomain.com>

Auto manuals search

<http://auto.somanuals.com>

TV manuals search

<http://tv.somanuals.com>