

HL-5280DW

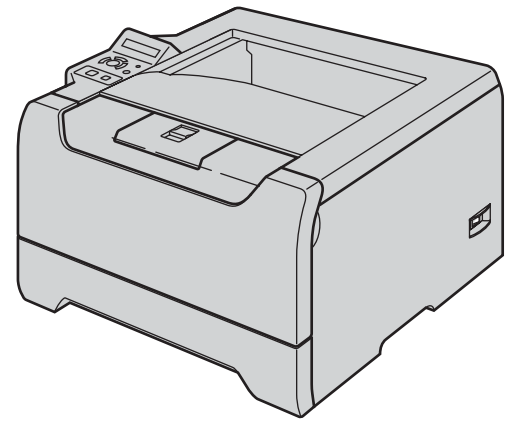

Before you can use the printer, you must set up the hardware and install the driver. Please read this 'Quick Setup Guide' for proper set up and installation instructions.

STEP 1

Setting Up the Machine



STEP 2

Installing the Printer Driver







Setup is Complete!



How to use the printer, see the User's Guide in the CD-ROM.

Keep this 'Quick Setup Guide' and the supplied CD-ROM in a convenient place for quick and easy reference at all times.

Symbols used in this guide

 Warning	 Electrical Hazard	 Hot Surface	 Caution
<p>Warnings tell you what to do to prevent possible personal injury.</p>	<p>Electrical Hazard icons alert you to a possible electrical shock.</p>	<p>Hot Surface icons warn you not to touch machine parts that are hot.</p>	<p>Cautions specify procedures you must follow or avoid to prevent possible damage to the printer or other objects.</p>
 Improper Setup	 Note	 User's Guide Network User's Guide	
<p>Improper Setup icons alert you to devices and operations that are not compatible with the printer.</p>	<p>Notes tell you how you should respond to a situation that may arise or give tips about how the current operation works with other features.</p>	<p>Indicates reference to the User's Guide or Network User's Guide which is on the CD-ROM we have supplied.</p>	

Safety Precautions	2
Regulations	3

Getting Started

What is in the box?	6
Control panel	7
Supplied CD-ROM	8

STEP 1— Setting Up the Machine

Put the CD-ROM into the CD-ROM drive	9
Install the drum unit and toner cartridge assembly	10
Load paper in the paper tray	11
Print a test page	12
Setting your language on the control panel	12

STEP 2— Installing the Printer Driver

Windows®

For USB interface cable users (Windows® 98/Me/2000/XP only)	14
For parallel interface cable users	16
For wired network interface cable users	17
For Brother Peer-to-Peer network printer users (LPR/NetBIOS)	17
For shared network printer users	19
For wireless network users (Windows® 98/Me/2000/XP and Windows NT® 4.0 only)	20

Macintosh®

For USB interface cable users	31
For Mac OS® X 10.2.4 or greater users	31
For Mac OS® 9.1 to 9.2 users	33
For wired network interface cable users	34
For Mac OS® X 10.2.4 or greater users	34
For Mac OS® 9.1 to 9.2 users	36
For wireless network users (Mac OS® X 10.2.4 or greater users)	37

For Network Users

BRAdmin Professional configuration utility (For Windows® users)	48
BRAdmin Light configuration utility (For Mac OS® X users)	49
Web browser	50
Network default settings	50
Print the Printer Settings Page	50

Consumables and Options

Options	51
Consumables	51

Repacking Information

Shipment of the printer	52
-------------------------------	----

Troubleshooting



To Use the Printer Safely

Warning



There are high voltage electrodes inside the printer. Before you clean the inside of the printer, make sure that you have turned off the power switch and unplugged the printer from the AC power outlet.

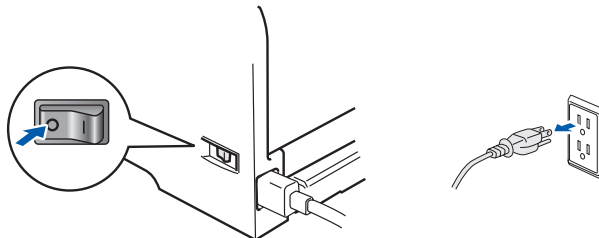

DO NOT handle the plug with wet hands. Doing this might cause an electrical shock.

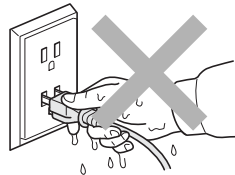

After you have just used the printer, some internal parts of the printer will be extremely hot. DO NOT touch the shaded parts shown in the illustration when you open the front or back cover of the printer.

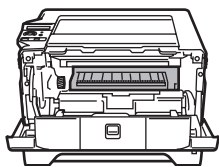

Inside the printer (Front View)

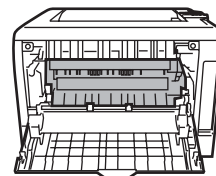

Open the back cover (Back View)



DO NOT remove or damage the caution labels located on or around the fuser.

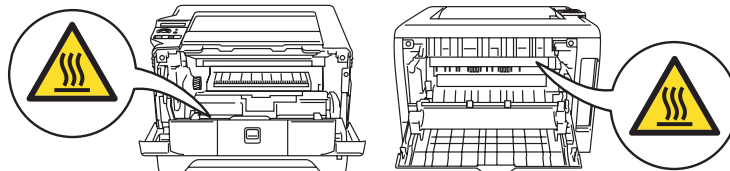

DO NOT use a vacuum cleaner to clean up scattered toner. Doing this might cause the toner dust to ignite inside the vacuum cleaner, potentially starting a fire. Please carefully clean the toner dust with a dry, lint-free cloth and dispose of it according to local regulations.



DO NOT use flammable substances near the printer. Doing this might cause a fire or electrical shock.

Regulations

Federal Communications Commission (FCC) Declaration of Conformity (For USA)

Responsible Party: Brother International Corporation
100 Somerset Corporate Boulevard
P.O. Box 6911
Bridgewater, NJ 08807-0911
USA
Telephone: (908) 704-1700

declares, that the products

Product name: Laser Printer HL-5280DW
Model number: HL-52
Product option: Lower Tray Unit LT-5300

comply with Part 15 of the FCC Rules. Operation is subject to the following two conditions: (1) This device may not cause harmful interference, and (2) this device must accept any interference received, including interference that may cause undesired operation.

This equipment has been tested and found to comply with the limits for a Class B digital device, pursuant to Part 15 of the FCC Rules. These limits are designed to provide reasonable protection against harmful interference in a residential installation. This equipment generates, uses, and can radiate radio frequency energy and, if not installed and used in accordance with the instructions, may cause harmful interference to radio communications. However, there is no guarantee that interference will not occur in a particular installation. If this equipment does cause harmful interference to radio or television reception, which can be determined by turning the equipment off and on, the user is encouraged to try to correct the interference by one or more of the following measures:

- Reorient or relocate the receiving antenna.
- Increase the separation between the equipment and receiver.
- Connect the equipment into an outlet on a circuit different from that to which the receiver is connected.
- Consult the dealer or an experienced radio/TV technician for help.

Important

A shielded interface cable should be used in order to ensure compliance with the limits for a Class B digital device.

Changes or modifications not expressly approved by Brother Industries, Ltd. could void the user's authority to operate the equipment.

Industry Canada Compliance Statement (For Canada)

This Class B digital apparatus complies with Canadian ICES-003.

Cet appareil numérique de la classe B est conforme à la norme NMB-003 du Canada.

Radio interference (220-240 volt model only)

This printer follows EN55022 (CISPR Publication 22)/Class B.

Before you use this product, make sure that you use one of the following interface cables.

- 1 A shielded parallel interface cable with twisted-pair conductors and that it is marked "IEEE 1284 compliant".
- 2 A USB cable.

The cable must not be more than 2 meters long.

EC Declaration of Conformity



EC Declaration of Conformity

Manufacturer
Brother Industries, Ltd.
15-1, Naeshirocho, Mizuho-ku, Nagoya 467-8561, Japan

Plant
Brother Corporation (Asia) Ltd. Brother Buji Nan Ling Factory
Gold Garden Ind., Nan Ling Village, Buji, Rong Gang, Shenzhen, China

Herewith declare that:

Product description : Laser Printer
Model Name : HL-5280DW

is in conformity with provisions of the R & TTE Directive (1999/5/EC) and we declare compliance with the following standards :

Standards applied :

Harmonized :

Safety	EN60950-1:2001
EMC	EN55022:1998 +A1:2000 +A2:2003 Class B
	EN55024:1998 +A1:2001 +A2:2003
	EN61000-3-2:2000
	EN61000-3-3:1995 +A1:2001
Radio	EN301 489-1 V1.4.1
	EN301 489-17 V1.2.1
	EN300 328 V1.6.1

Year in which CE marking was First affixed : 2005

Issued by : Brother Industries, Ltd.
Date : 28th December, 2005
Place : Nagoya, Japan
Signature :

Takashi Maeda
Manager
Quality Management Group
Quality Management Dept.
Information & Document Company

Safety Precautions

Laser Safety (110 to 120 volt Model Only)

This printer is certified as a Class 1 laser product under the U.S. Department of Health and Human Services (DHHS) Radiation Performance Standard according to the Radiation Control for Health and Safety Act of 1968. This means that the printer does not produce hazardous laser radiation.

Since radiation emitted inside the printer is completely confined within protective housings and external covers, the laser beam cannot escape from the machine during any phase of user operation.

FDA Regulations (110 to 120 volt Model Only)

The U.S. Food and Drug Administration (FDA) has implemented regulations for laser products manufactured on and after August 2, 1976.

Compliance is mandatory for products marketed in the United States. One of the following labels on the back of the printer indicates compliance with the FDA regulations and must be attached to laser products marketed in the United States.

MANUFACTURED:

Brother Industries, Ltd.,
15-1 Naeshiro-cho Mizuho-ku Nagoya, 467-8561 Japan
This product complies with FDA performance standards for laser products except for deviations pursuant to Laser Notice No.50, dated July 26, 2001.

MANUFACTURED:

Brother Corporation (Asia) Ltd. Brother Buji Nan Ling
Factory Gold Garden Ind., Nan Ling Village, Buji, Rong
Gang, Shenzhen, CHINA
This product complies with FDA performance standards for laser products except for deviations pursuant to Laser Notice No.50, dated July 26, 2001.

! Caution

Use of controls, adjustments or performance of procedures other than those specified in this manual may result in hazardous radiation exposure.

IEC 60825-1 specification (220 to 240 volt model only)

This printer is a Class 1 laser product as defined in IEC 60825-1 specifications. The label shown below is attached in countries where it is needed.



This printer has a Class 3B laser diode which produces invisible laser radiation in the laser unit. You should not open the laser unit under any circumstances.

! Caution

Use of controls or adjustments or performance of procedures other than those specified herein may result in hazardous radiation exposure.

For Finland and Sweden

LUOKAN 1 LASERLAITE
KLASS 1 LASER APPARAT

! Varoitus!

Laitteen käyttäminen muulla kuin tässä käyttöohjeessa mainitulla tavalla saattaa altistaa käyttäjän turvallisuusluokan 1 ylittävälle näkymättömälle lasersäteilylle.

! Varning

Om apparaten används på annat sätt än i denna Bruksanvisning specificerats, kan användaren utsättas för osynlig laserstrålning, som överskrider gränsen för laserklass 1.

Internal laser radiation

Maximum radiation power:	5 mW
Wave length:	770 - 810 nm
Laser class:	Class 3B

IMPORTANT - For Your Safety

To ensure safe operation, the supplied three-pin plug must be inserted only into a standard three-pin power outlet that is properly grounded through the normal household wiring.

Extension cords used with this printer must be three-pin plug type and correctly wired to provide proper grounding. Incorrectly wired extension cords may cause personal injury and equipment damage.

The fact that the equipment operates satisfactorily does not imply that the power is grounded and that the installation is completely safe. For your safety, if in any doubt about the effective grounding of the power, call a qualified electrician.

This product should be connected to an AC power source within the range indicated on the rating label. DO NOT connect it to a DC power source. If you are not sure, contact a qualified electrician.

Disconnect device

You must install this printer near a power outlet that is easily accessible. In case of an emergency, you must disconnect the power cord from the power outlet to shut off the power completely.

Caution for LAN connection

Connect this product to a LAN connection that is not subjected to over voltages.

IT power system (For Norway only)

This product is also designed for an IT power system with phase-to-phase voltage 230V.

Wiring information (for UK)

Important

If you need to replace the plug fuse, fit a fuse that is approved by ASTA to BS1362 with the same rating as the original fuse.

Always replace the fuse cover. Never use a plug that does not have a cover.

Warning - This printer must be earthed.

The wires in the mains lead are coloured in line with the following code:

Green and Yellow: Earth
Blue: Neutral
Brown: Live

If in any doubt, call a qualified electrician.

Wi-Fi Alliance certification

This wireless Ethernet multi-function print server is a Wi-Fi certified IEEE 802.11b/802.11g product by the Wi-Fi Alliance. For more information on the Wi-Fi Alliance and other Wi-Fi certified products, visit <http://www.wi-fi.org>.





What is in the box?

Carton components may vary from one country to another.

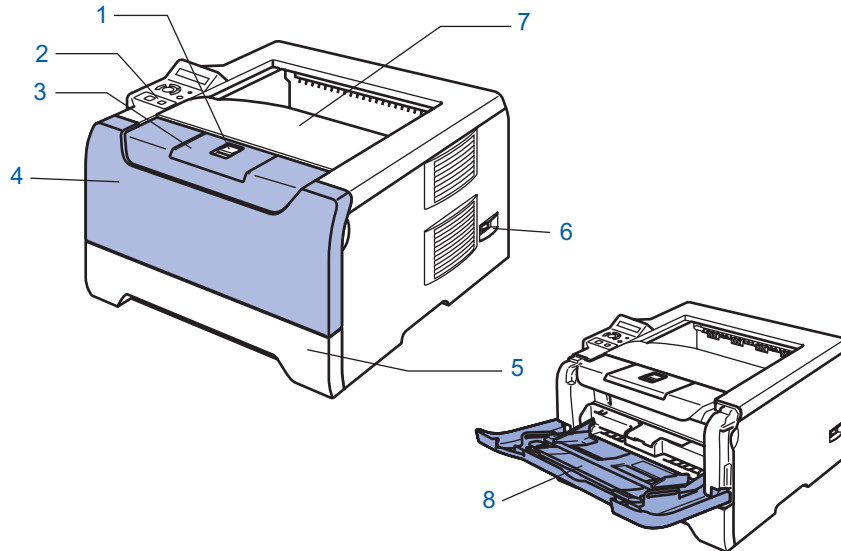
Save all packing materials and the printer carton in case for any reason you must ship your printer.

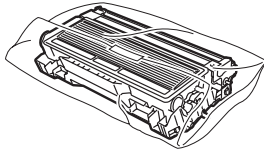
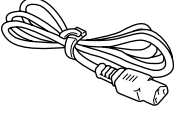

- | | |
|---|---------------------------------|
| 1 Front Cover Release Button | 5 Paper tray |
| 2 Control panel | 6 Power switch |
| 3 Face-down output tray support flap (Support flap) | 7 Face-down output tray |
| 4 Front cover | 8 Multi -purpose tray (MP tray) |

 <p>CD-ROM (including User's Guide)</p>	 <p>Quick Setup Guide</p>	 <p>Drum Unit and Toner Cartridge Assembly</p>	 <p>AC Power Cord</p>
---	---	---	---

The interface cable is not a standard accessory. Buy the proper interface cable for the interface you want to use (USB, Parallel or Network).

■ **USB cable**

Do not use a USB interface cable that is longer than 6 feet (2.0 meters).

Do not connect the USB cable to a non-powered hub or a Macintosh® keyboard.

Make sure that you connect it to the USB connector of your PC.

USB is not supported under Windows® 95 or Windows NT® 4.0.

■ **Parallel interface**

Do not use a parallel interface cable that is longer than 6 feet (2.0 meters).

Use a shielded interface cable that is IEEE 1284-compliant.

■ **Network cable**

Use a straight-through Category5 (or greater) twisted-pair cable for 10BASE-T or 100BASE-TX Fast Ethernet Network.

Control panel

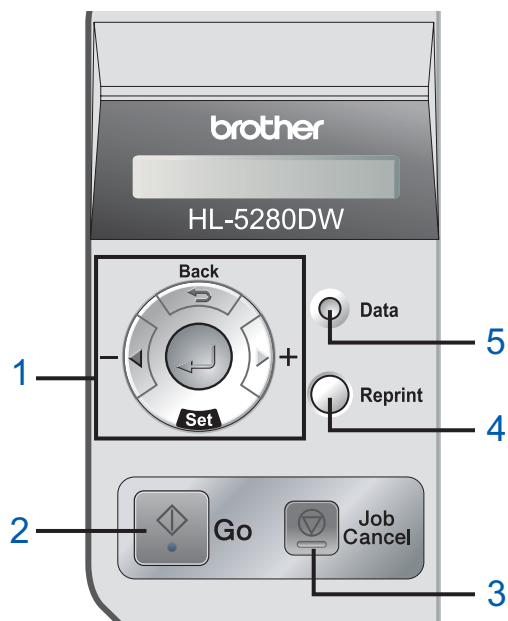

1 Menu buttons

- +
Move forward through menus.
- -
Move backward through menus.
- **Set**
Choose the control panel menu.
Select the chosen menus and settings.
- **Back**
Go back one level in the menu structure.

2 Go button

- Exit from the control panel menu and reprint setting.
- Clear error messages.
- Pause and Continue printing.

3 Job Cancel button

- Stop and cancel the print operation in progress.

4 Reprint button

- Choose the reprint menu and the number of extra copies (1-999).

It is recommended that you increase the RAMDISK size when you want to use the Reprint functions.

5 Data LED: Orange

- On
Data is in the printer memory.
- Blinking
Receiving / processing data or cooling down the printer.
- Off
No remaining data in the memory.



For the control panel details, see Chapter 4 of the User's Guide on the CD-ROM.

Supplied CD-ROM

You can find a variety of information on the CD-ROM.

Windows®

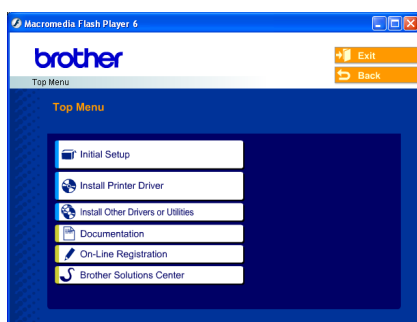

Macintosh®

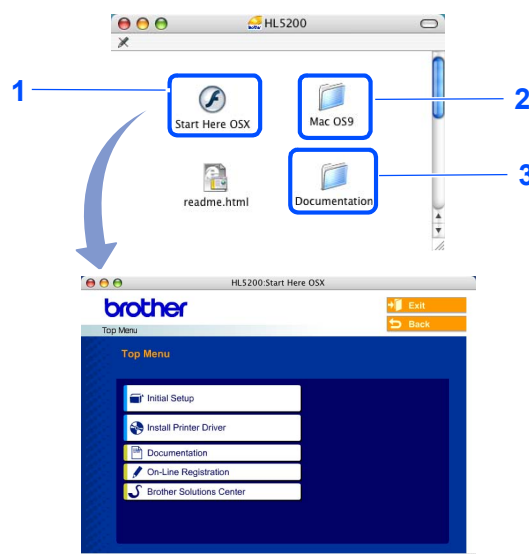

- 1 Mac OS® X 10.2.4 or greater Users
- 2 Mac OS® 9.1 to 9.2 Users
The menu screen is not supported by Mac OS® 9.1 to 9.2.
- 3 View the User's Guide and Network User's Guide in PDF format.
(See  Documentation below.)

Initial Setup

Instructional movie for printer setup.



Install Printer Driver

Install the printer driver.



Install Other Driver or Utilities (For Windows® users)

Install optional drivers, utilities and Network management tools.



Documentation

View the Printer User's Guide and Network User's Guide in PDF format (Viewer included).

You can also view the User's Guide in HTML format by accessing the Brother Solutions Center.

The User's Guide in PDF format will be installed automatically when you install the driver. (For Windows® users only) Click the **Start** button, **Programs**¹, your printer (e.g. Brother HL-5280DW), and then User's Guide. If you do not want to install the User's Guide, choose **Custom setup** from **Install Printer Driver**, and uncheck **User's Guide in PDF format** when you install the driver.

¹ All Programs for Windows® XP users



On-Line Registration

Register your product on-line.



Brother Solutions Center

The Brother Solutions Center (<http://solutions.brother.com>) is a one-stop resource for all your printer needs. Download the latest drivers and utilities for your printers, read FAQs and troubleshooting tips, or learn about printer solutions.



Note

For visually impaired users, we have prepared an HTML file on the supplied CD-ROM: readme.html. This file can be read by Screen Reader text-to-speech software.

STEP 1 Setting Up the Machine

1 Put the CD-ROM into the CD-ROM drive

For Windows® users

⊘ Improper Setup

DO NOT connect the interface cable. Connecting the interface cable is done when installing the driver.

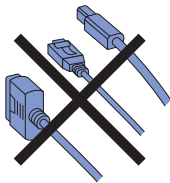

- 1 Put the supplied CD-ROM into your CD-ROM drive. The opening screen will appear automatically. Choose your printer model and the language.

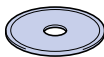

- 2 Click **Initial Setup** on the menu screen.



- 3 You can view the initial setup instructions and follow along with the steps on pages 10 to 12.

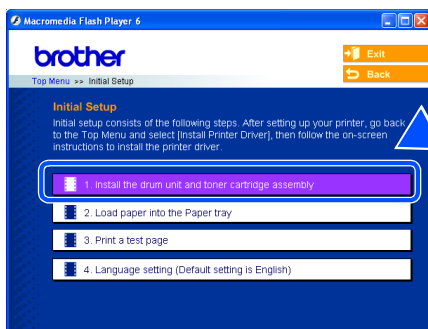

For Macintosh® users

⊘ Improper Setup

DO NOT connect the interface cable. Connecting the interface cable is done when installing the driver.

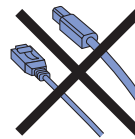

- 1 For Mac OS® 9.1 to 9.2 Users, go to next page. For Mac OS® 10.2.4 or greater Users, put the supplied CD-ROM into your CD-ROM drive, and then double-click the **HL5200** icon on your desktop. Double-click the **Start Here OS X** icon. Follow the on-screen instructions.

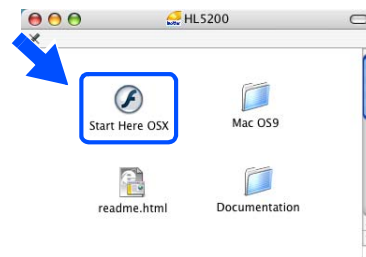

- 2 Click **Initial Setup** on the menu screen.



- 3 You can view the initial setup instructions and follow along with the steps on pages 10 to 12.

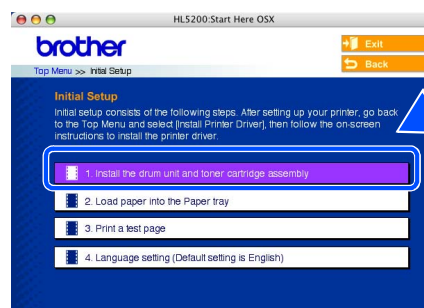

2 Install the drum unit and toner cartridge assembly

⊘ Improper Setup

DO NOT connect the interface cable yet.

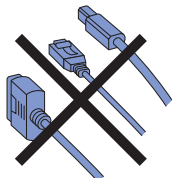

- 1 Press the front cover release button and open the front cover (1).

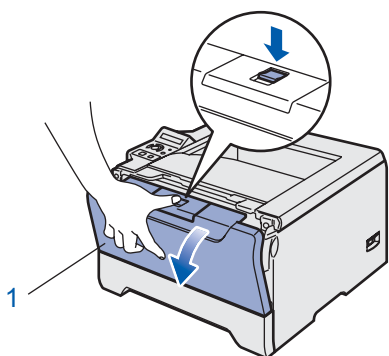

- 2 Unpack the drum unit and toner cartridge assembly.

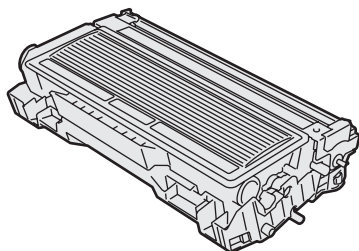

- 3 Rock it from side to side several times to distribute the toner evenly inside the assembly.

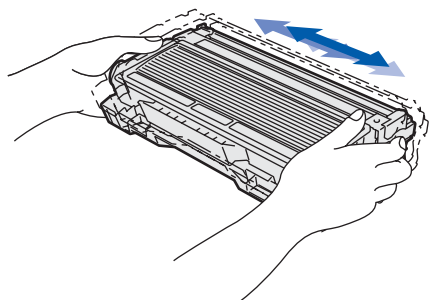

- 4 Put the drum unit and toner cartridge assembly into the printer until it clicks into place.

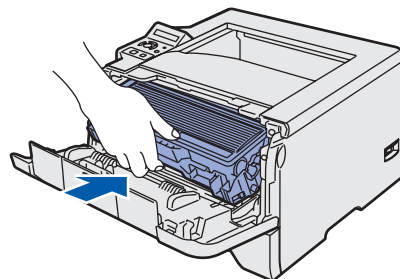

- 5 Close the front cover of the printer.

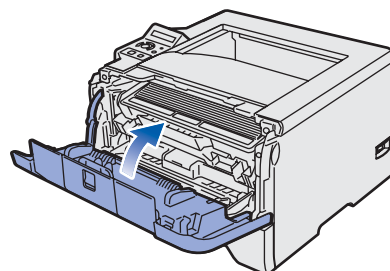

3 Load paper in the paper tray

1 Pull the paper tray completely out of the printer.

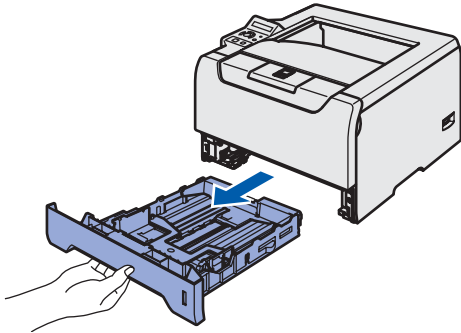

2 While pressing the blue paper-guide release lever (1), slide the paper guides to fit the paper size. Make sure that the guides are firmly in the slots.

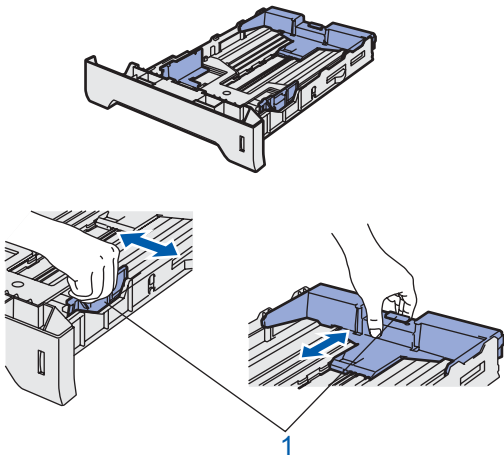

3 Fan the stack of paper well to avoid paper jams and misfeeds.

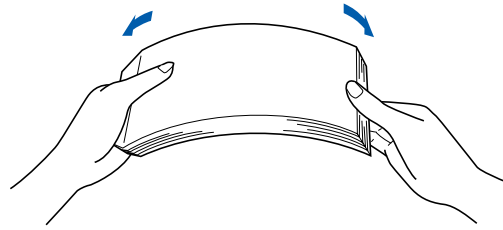

4 Put paper in the paper tray. Make sure that the paper is flat in the tray and below the maximum paper mark (1).

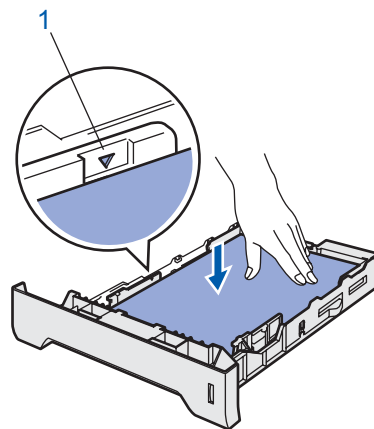

5 Put the paper tray firmly back in the printer.

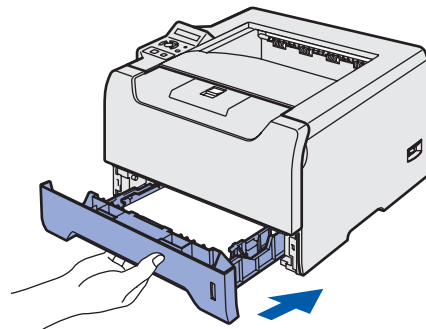

Note

Not applicable for European countries
For Legal size paper, press the lever (1) located at the back of the tray and pull out the back of the paper tray. Move the tray lock button (2) to the lock position.
(Legal size paper is not available in some regions.)

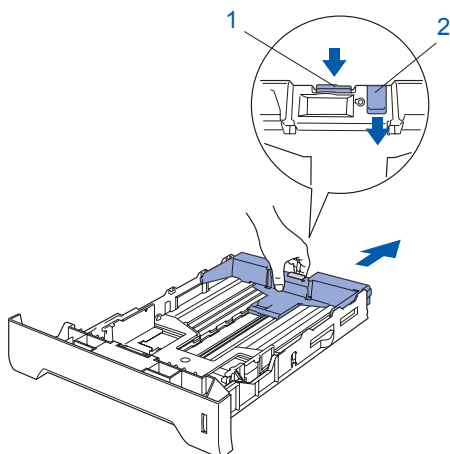

STEP 1 Setting Up the Machine

4 Print a test page

⊘ Improper Setup

DO NOT connect the interface cable yet.

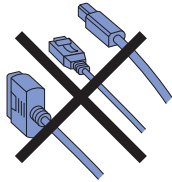

- 1 Make sure that the printer power switch is off. Connect the AC power cord to the printer.

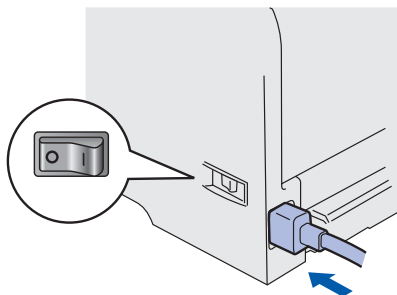

- 2 Plug the AC power cord into an AC power outlet. Turn on the printer power switch.

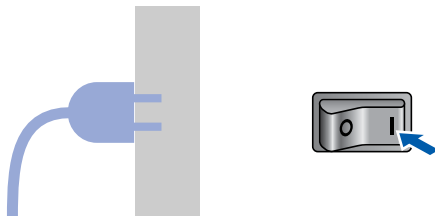

- 3 After the printer has finished warming up, the LCD shows **READY**.

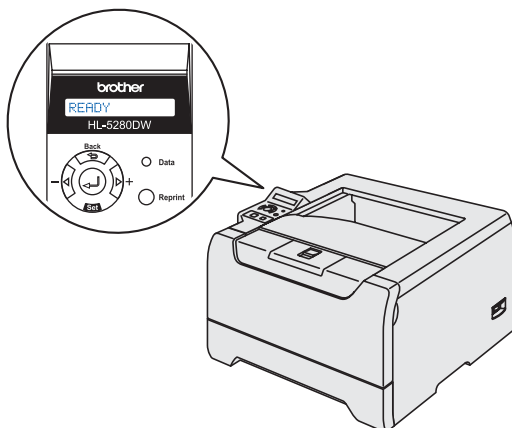

- 4 Press **Go**. The printer prints a test page. Check that the test page has printed correctly.

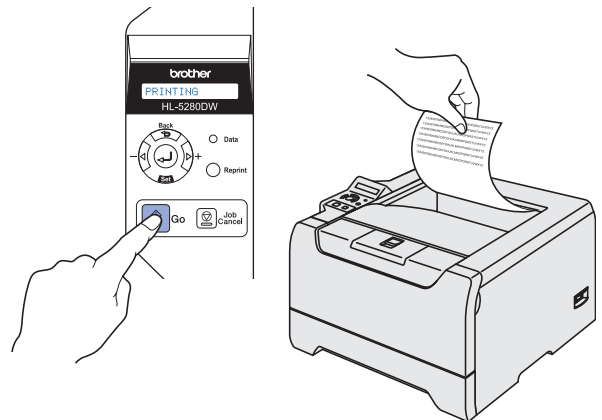

📝 Note

This function will not be available after the first print job you send from your PC.

5 Setting your language on the control panel



- 1 Press the **+** button until the LCD shows **SETUP**. Press **Set**.

SETUP

- 2 Press **Set** again.

LANGUAGE

- 3 Press the **+** or **-** button to choose your language. Press **Set** to accept.

=ENGLISH

Now go to

Go to the next page to install the driver.

STEP 2

Installing the Printer Driver

Follow the instructions on this page for your operating system and interface cable.
For the latest driver and to find the best solution for your problem or question, access the Brother Solutions Center directly from the CD-ROM / Driver or visit <http://solutions.brother.com>.

Windows®



For Windows® XP Professional x64 Edition users, visit <http://solutions.brother.com> for driver downloads and installation steps.

For USB interface cable users (Windows® 98/Me/2000/XP only) 14



For parallel interface cable users 16



For wired network interface cable users 17



- For Brother Peer-to-Peer network printer users (LPR/NetBIOS) 17
- For shared network printer users 19

For wireless network users (Windows® 98/Me/2000/XP and Windows NT® 4.0 only) 20



Macintosh®

For USB interface cable users 31



- For Mac OS® X 10.2.4 or greater users 31
- For Mac OS® 9.1 to 9.2 users 33

For wired network interface cable users 34



- For Mac OS® X 10.2.4 or greater users 34
- For Mac OS® 9.1 to 9.2 users 36

For wireless network users (Mac OS® X 10.2.4 or greater users) 37



The screens for Windows® in this Quick Setup Guide are based on Windows® XP.
The screens for Mac OS® X in this Quick Setup Guide are based on Mac OS® X 10.4.

For USB interface cable users (Windows® 98/Me/2000/XP only)



Note

If the **Found New Hardware Wizard** appears on your PC, click **Cancel**.

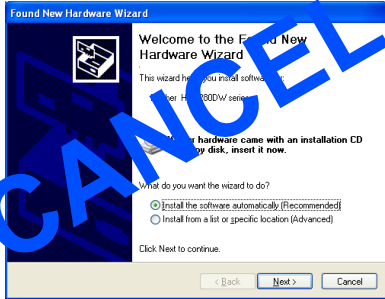

Installing the driver and connecting the printer to your PC

- 1 Make sure the USB interface cable is **NOT** connected to the printer, and then begin installing the driver. If you have already connected the cable, remove it.

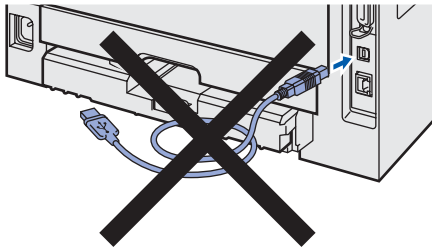

- 2 Click **Install Printer Driver** on the menu screen.



- 3 Click **USB cable users**.



- 4 When the License Agreement window appears, click **Yes** if you agree to the License Agreement.

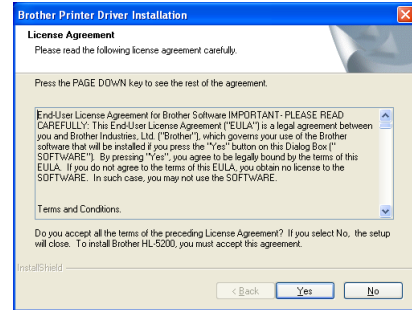

- 5 When this screen appears, make sure the printer power switch is on. Connect the USB interface cable to your PC, and then connect it to the printer. Click **Next**.

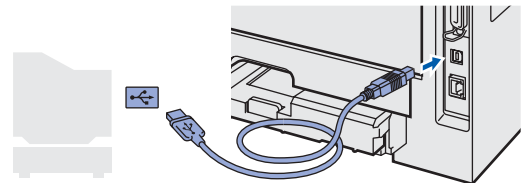
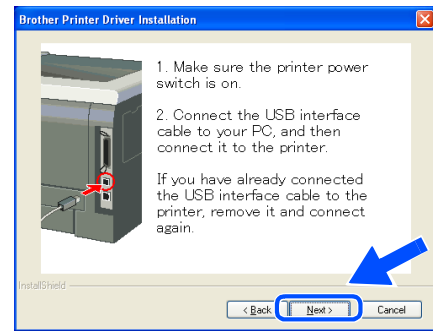

- 6 Click **Finish**.

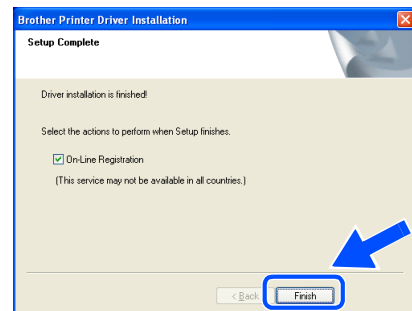



Note

If you want to register your product on-line, check **On-Line Registration**.



For Windows® 98/Me users, the setup is now complete.

Now go to

For Windows® 2000/XP users, go to 'Setting Your Printer as the Default Printer'.

Setting your printer as the default printer (For Windows® 2000/XP only)

- 1 Click the **Start** button and then **Printers and Faxes**.

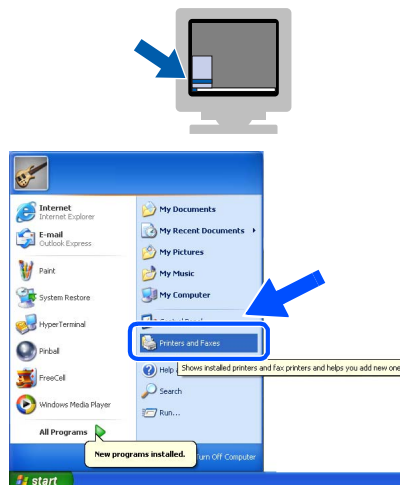

- 2 Choose the Brother Printer icon.

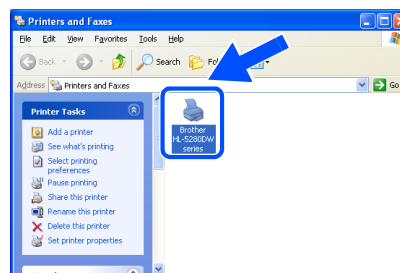

- 3 Click **File**, and then **Set as Default printer**.

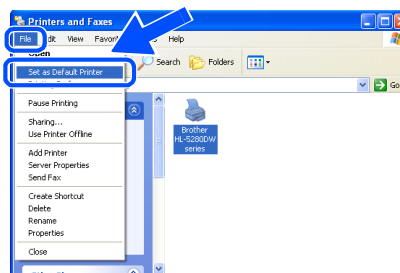

The setup is now complete.

For parallel interface cable users



Note
If the **Found New Hardware Wizard** appears on your PC, click **Cancel**.

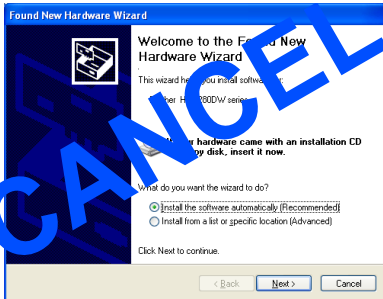

4 Click **Finish**.

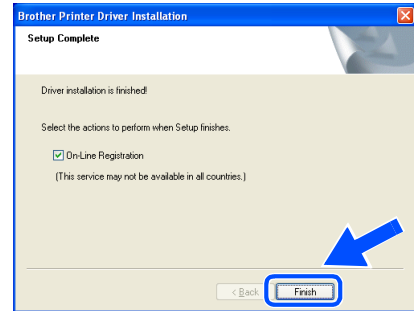

Note
If you want to register your product on-line, check **On-Line Registration**.

Connecting the printer to your PC and installing the driver

1 Click **Install Printer Driver** on the Menu screen.



2 Click **Parallel cable users**.



3 When the License Agreement window appears, click **Yes** if you agree to the License Agreement.

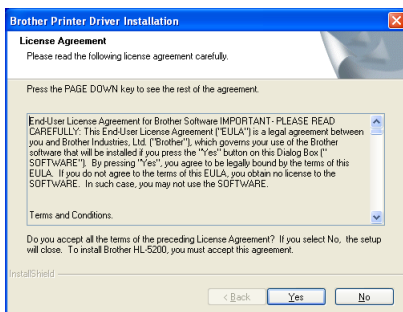

5 Turn off the printer power switch.



6 Connect the parallel interface cable to your PC, and then connect it to your printer.

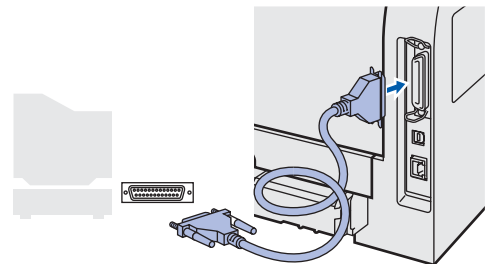

7 Turn on the printer power switch.



OK! The setup is now complete.

For wired network interface cable users

For Brother Peer-to-Peer network printer users (LPR/NetBIOS)

Note

- If you are going to connect the printer to your network, we recommend that you contact your system administrator prior to installation or see the Network User's Guide.
- Before installation, if you are using Personal Firewall software (e.g. the Internet Connection Firewall available in Windows XP), disable it. Once you are sure that you can print, restart your Personal Firewall software.
- Peer-to-peer print with NetBIOS is not available for Windows® XP x64 Edition.

Connecting the printer to your network and installing the driver

1 Click **Install Printer Driver** on the menu screen.



2 Click **Network cable users**.



3 Turn off the printer power switch.



4 Connect the network interface cable to the printer, and then connect it to a free port on your hub.

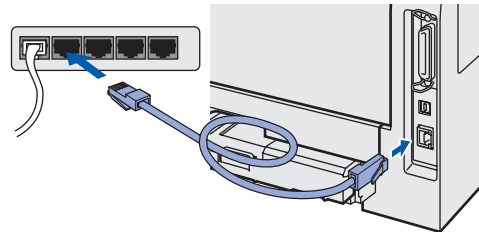

5 Turn on the printer power switch.



6 When the License Agreement window appears, click **Yes** if you agree to the License Agreement.

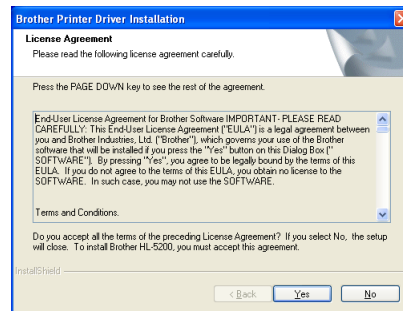

7 Choose **Brother Peer-to-Peer Network Printer**, and then click **Next**.

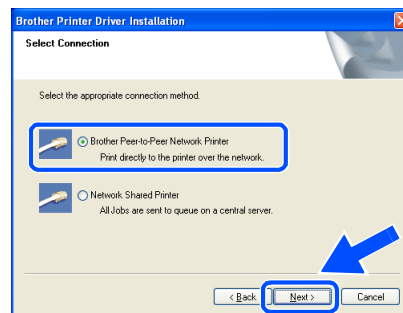

8 For LPR Users:
Choose **Search the network for devices and choose from a list of discovered devices (Recommended)**. Or enter your printer's IP address or its node name. Click **Next**.

For NetBIOS Users:
Choose **Search the network for devices and choose from a list of discovered devices (Recommended)**. Click **Next**.

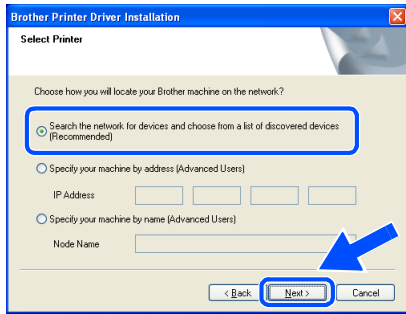

Note
Contact your administrator if you do not know the printer's IP address or node name.

9 For LPR Users:
Choose your printer and choose **LPR (Recommended)**, and then click **Next**.

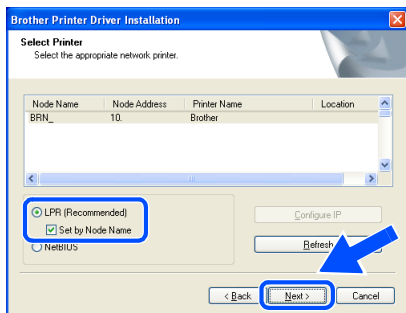

For NetBIOS Users:
Choose your printer and **NetBIOS**, and then click **Next**.

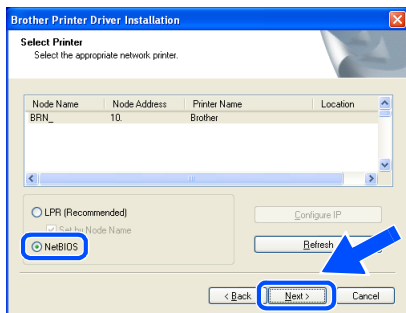

10 Click **Finish**.

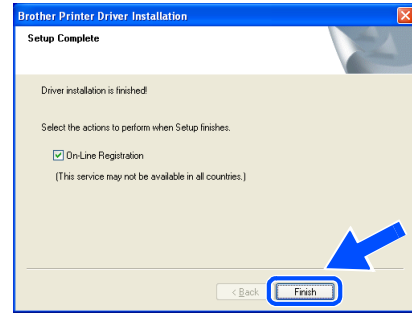

Note
If you want to register your product on-line, check **On-Line Registration**.

OK! For Windows NT® 4.0 and Windows® 2000/XP users, the setup is now complete.

OK! For Windows® 95/98/Me users, the setup will be complete after your PC has restarted.

For shared network printer users

Note

If you are going to connect to a shared printer on your network, we recommend that you ask your system administrator about the queue or share name prior to installation.

Installing the driver and choosing the proper printer queue or share name

1 Click **Install Printer Driver** on the menu screen.



2 Click **Network cable users**.



3 When the License Agreement window appears, click **Yes** if you agree to the License Agreement.

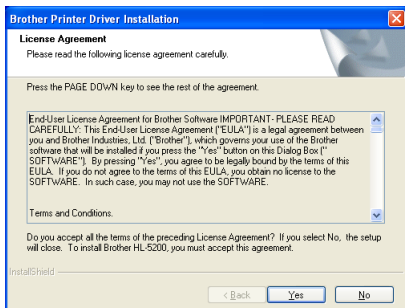

4 Choose **Network Shared Printer**, and then click **Next**.

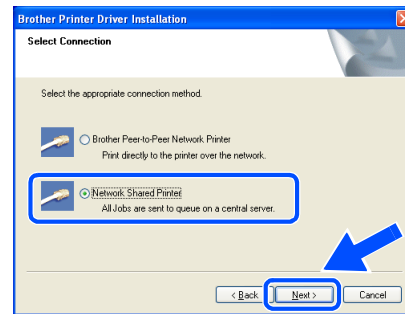

5 Choose your printer's queue, and then click **OK**.

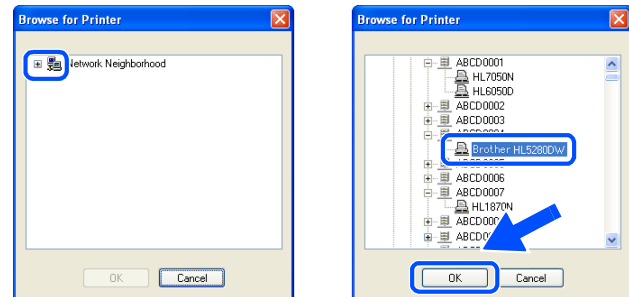

Note

Contact your administrator if you do not know about the location and name of the printer in the network.

6 Click **Finish**.

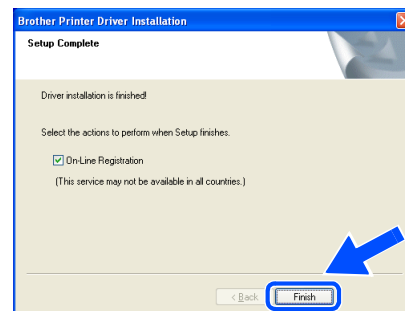

Note

If you want to register your product on-line, check **On-Line Registration**.

OK! The setup is now complete.

For wireless network users (Windows® 98/Me/2000/XP and Windows NT® 4.0 only)

Connect your wireless printer and wireless network together: install the printer driver in infrastructure mode

First you must configure the wireless network settings of your printer to communicate with your network access point (router). After the printer is configured to communicate with your access point (router) computers on your network will have access to the printer. To use the printer from these computers, you will need to install the printer driver. The following steps will guide you through the configuration and installation process.

To achieve optimum results with normal every day document printing, place the Brother printer as close to the network access point (router) as possible with minimal obstructions. Large objects and walls between the two devices as well as interference from other electronic devices can affect the data transfer speed of your documents.

Due to these factors, wireless may not be the best method of connection for all types of documents and applications. If you are printing large files, such as photos or multi-page documents with mixed text and large graphics, you may want to consider choosing wired Ethernet for a faster data transfer, or USB for the fastest throughput speed.

Important

The following instructions will install your Brother printer in a wireless network environment in infrastructure mode, using a wireless router or access point that uses DHCP to assign IP addresses. If you want to setup your printer in any other wireless environment you can find instructions in the Network User's Guide on the CD-ROM.

Note

- If you are going to connect the printer to your network, we recommend that you contact your system administrator prior to installation.
- Before installation, if you are using Personal Firewall software (e.g. the Internet Connection Firewall available in Windows XP), disable it. Once you are sure that you can print, restart your Personal Firewall software.



Infrastructure Mode

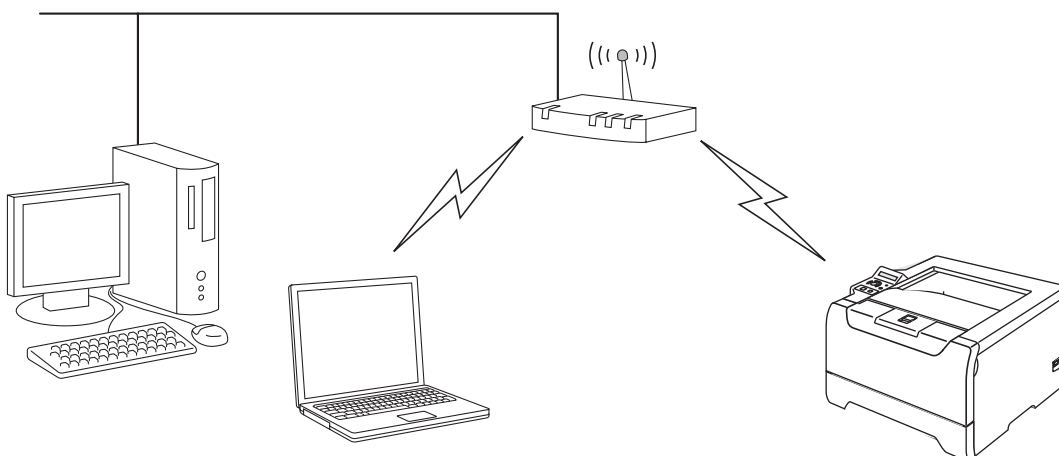

Confirm your network environment

The setup process will be different depending on your network environment.

■ Installation using SecureEasySetup™.

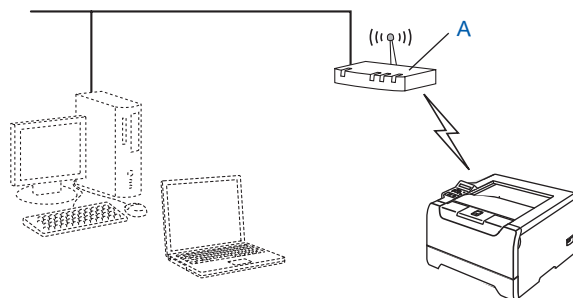

If your wireless access point (A) supports SecureEasySetup™, you do not need to use a computer to configure the printer. The access point (router) and your printer can automatically negotiate using the SecureEasySetup™ procedure.

For instructions, see Chapter 3 in the Network User's Guide on the CD-ROM.

■ Installation temporarily using a network cable.

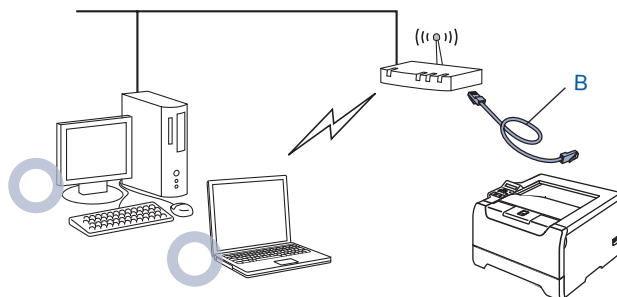

If there is an Ethernet Hub or Router in the same network as the wireless access point of your printer, you can temporarily connect the Hub or Router to the printer using an Ethernet cable (B), this is an easy way to configure the printer. You can then remotely configure the printer from a computer on the network.

For instructions, go to page 22.

■ Installation using a wireless computer.

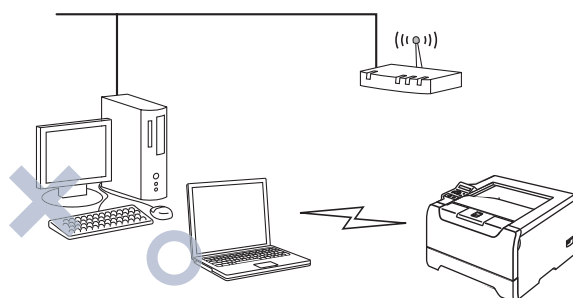

If a computer of yours has wireless capability, you will need to change the wireless settings of the computer to Ad-hoc mode so you can directly connect and configure the printer.

For instructions, go to page 26.

■ Installation using the control panel.

You can also configure the wireless settings of your printer, by using the control panel.

For instructions, see Chapter 3 in the Network User's Guide on the CD-ROM.

Installation temporarily using a network cable

Improper Setup

If you have previously configured the wireless settings of the printer, you must reset the NETWORK menu settings before you can configure the wireless settings again.

- 1 Press the + or - button to choose NETWORK. Press Set.
- 2 Press the + or - button to choose FACTORY RESET. Press Set.
- 3 Press Set again.

- 1 Make sure that the printer power switch is on.



- 2 Click **Install Printer Driver** on the menu screen.



- 3 Click **Wireless Network users**.



- 4 Choose **Wireless Setup and Driver Install**, and then click **Next**.



- 5 Choose **Automatic (Recommended)** and then click **Next**.

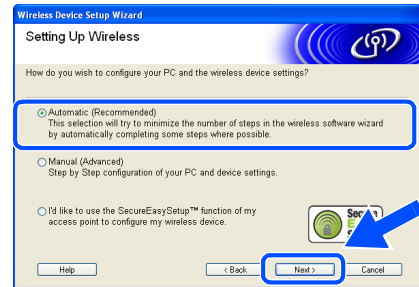

- 6 Choose **I'm able to temporarily connect my device to my access point with a network cable** and then click **Next**.

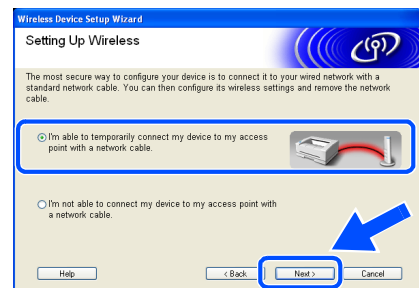

- 7 For configuration, you must temporarily connect your Brother wireless device (your printer) directly to a free port on your access point, hub or router using a network cable. When the following screen appears, insert the network cable to the access point and then to the printer. Click **Next**.

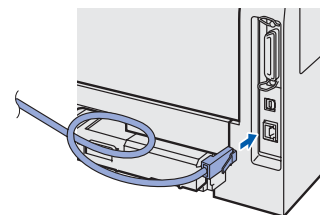
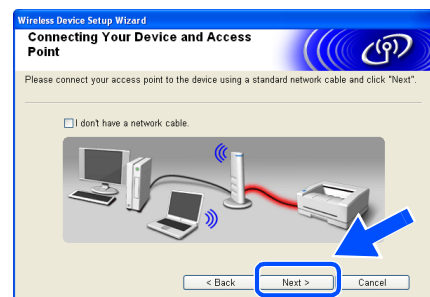

8 If more than one wireless printer is available on the network, a list of them will appear. If the list is blank, check that the access point and the printer are switched on, and then click **Refresh**. Choose the printer you wish to configure, and click **Next**.



• If your target wireless network does not appear on the list, you can manually add it by clicking the **Add** button. Follow the on-screen instructions for entering the **Name (SSID)** and the **Channel number**.

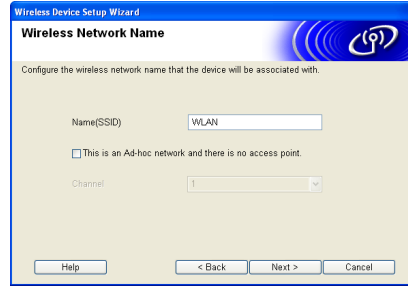

Note

- The Default Node name of the printers network card is "BRN_XXXXXX" (where "XXXXXX" is the last six digits of the Ethernet address).
- If you are using Personal Firewall software (e.g. the Internet Connection Firewall available in Windows XP), temporarily disable it.



10 If your network is not configured for Authentication and Encryption, the following screen will appear. To continue installation, click **OK**. Go to Step **12**.



9 The wizard will search for wireless networks available from your printer. If more than one wireless network is available, the following list appears. Choose the wireless network you wish to associate the printer with, and then click **Next**.

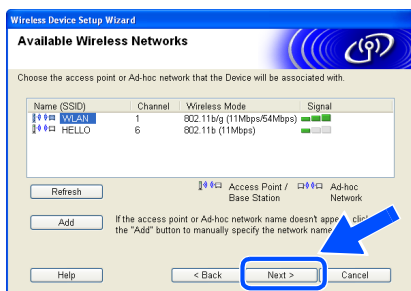

11 If your network is configured for Authentication and Encryption the following screen will appear. When configuring your Brother wireless printer, you must ensure that it is configured to match the Authentication and Encryption settings of your existing wireless network. Choose the **Authentication Method** and **Encryption Mode** from the pull-downs in each setting box. Then enter the **Network Key** and click **Next**.

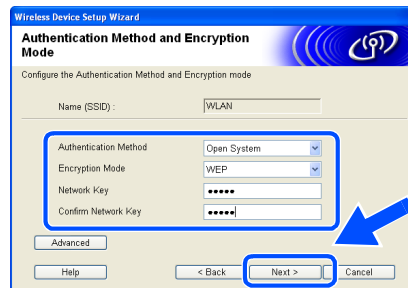

Note

- "SETUP" is the default SSID of the printer. Do not choose this SSID.
- If the list is blank, check that the printer is within range of the access point for wireless communication. Then, click **Refresh**.

Note

- If you want to set more than one WEP key, click **Advanced**.
- If you want to configure LEAP security, see the *Network User's Guide*.
- If you do not know the Authentication or Encryption settings for your network contact your network administrator.

- 12** Click **Next**. The settings will be sent to your printer. The settings will remain unchanged if you click **Cancel**.

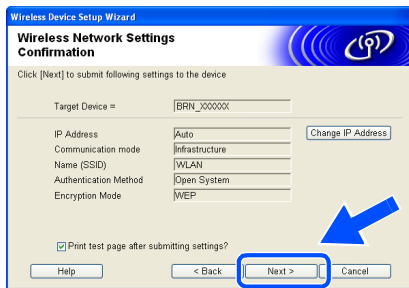

Note

If you want to manually enter the IP address settings of your printer, click **Change IP Address** and enter the necessary IP address settings for your network. After making your selection, click **Next** and the Wizard will search for available wireless networks.

- 13** Disconnect the network cable between your access point (hub or router) and the printer, and click **Next**.



Note

Wireless communication will not start until you have disconnected the network cable.

Installing the printer driver

⊘ Improper Setup

- **DO NOT** try to cancel any of the screens during this installation.
- If your wireless settings fail, an error message will appear during the installation of printer driver and the installation will be terminated. If you encounter this failure, please go to step 1 and setup the wireless connection again.

Note

Peer-to-peer print with NetBIOS is not available for Windows® XP x64 Edition.

- 14** The driver installation starts. When the License Agreement window appears, click **Yes** if you agree to the License Agreement.

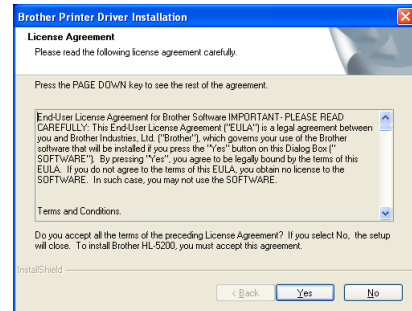

- 15** Choose **Standard Installation**, and then click **Next**.

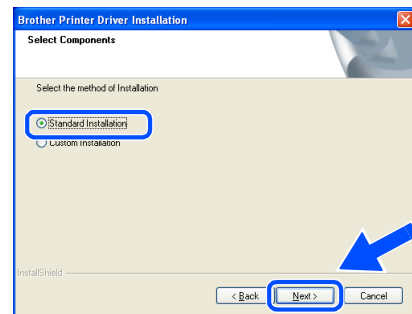

- 16** For LPR Users:
Choose **Search the network for devices and choose from a list of discovered devices (Recommended)**. Or enter your printer's IP address or its node name. Click **Next**.

For NetBIOS Users:

Choose **Search the network for devices and choose from a list of discovered devices (Recommended)**. Click **Next**.

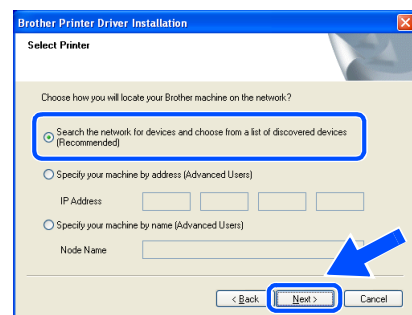

- 17** For LPR Users:
Choose your printer and choose LPR (Recommended), and then click Next.

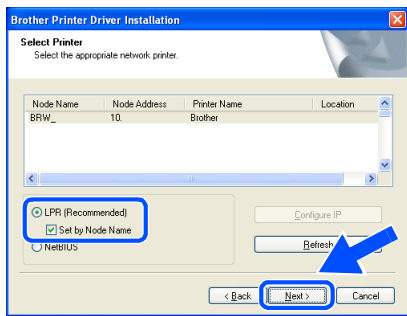

OK! For Windows NT® 4.0 and Windows® 2000/XP users, the setup is now complete.

OK! For Windows® 98/Me users, the setup will be complete after your PC has restarted.

Note

If your printer takes a long time (about 1 minute) to appear on the list, click **Refresh**.

For NetBIOS Users:

Choose your printer and **NetBIOS**, and then click **Next**.

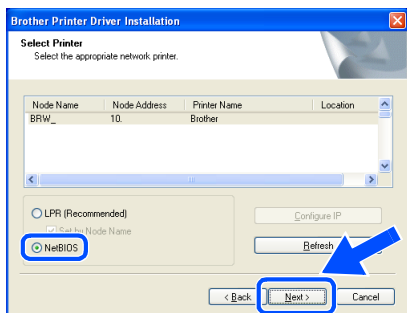

Note

If your printer takes a long time (about 1 minute) to appear on the list, click **Refresh**.

- 18** Click **Finish**.

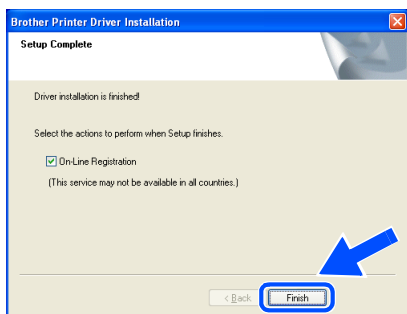

Note

- If you want to register your product on-line, check **On-Line Registration**.
- Turn your **Personal Firewall** back on.

Installation using a wireless computer

⊘ Improper Setup

If you have previously configured the wireless settings of the printer, you must reset the NETWORK menu settings before you can configure the wireless settings again.

- 1 Press the + or - button to choose NETWORK. Press Set.
- 2 Press the + or - button to choose FACTORY RESET. Press Set.
- 3 Press Set again.

- 1 Make sure that the printer power switch is on.



- 2 Click **Install Printer Driver** on the menu screen.



- 3 Click **Wireless Network users**.



- 4 Choose **Wireless Setup and Driver Install**, and then click Next.



- 5 Choose **Automatic (Recommended)** and then click **Next**.

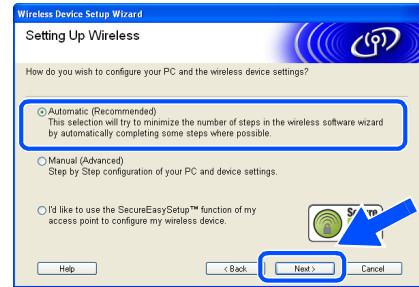

- 6 Choose **I'm not able to connect my device to my access point with a network cable** and then click **Next**.

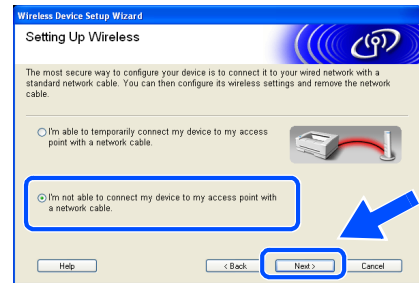

- 7 If you have chosen **This PC has wireless capability**, check **I am using an access point in infrastructure mode**, and then click **Next**.

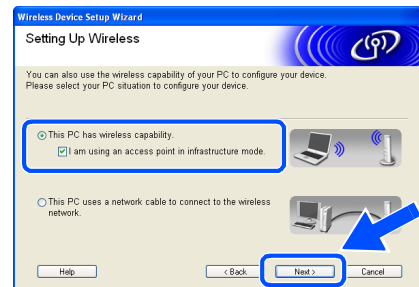

If you choose **This PC uses a network cable to connect to the wireless network**, you must configure the wireless settings from the control panel. Click **Next** and follow the on-screen instructions to complete the setup. (See Chapter 3 in the Network User's Guide on the CD-ROM.) When finished, go to the driver installation in step 16 on page 29.



8 You need to temporarily change your PC's wireless settings. Please follow the on-screen instructions. Please make sure you take notes on all the settings such as SSID or channel of your PC. You will need them to return your PC back to its original wireless settings. Click **Next**.

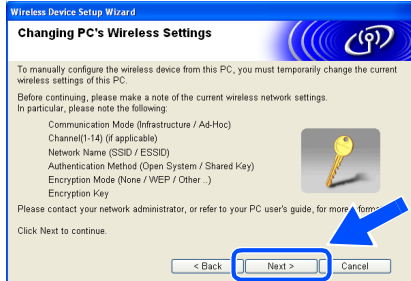

Item	Record the current wireless computer settings
Communication mode (Infrastructure / Ad-hoc)	
Channel (1-14)	
Network name (SSID / ESSID)	
Authentication method (Open system / Shared key / Other)	
Encryption (None / WEP / Other)	
Encryption key	

9 To communicate with the un-configured wireless printer, temporarily change the wireless settings on your PC to match printer's default settings shown on this screen. Check **Checked and confirmed**, and then click **Next**.

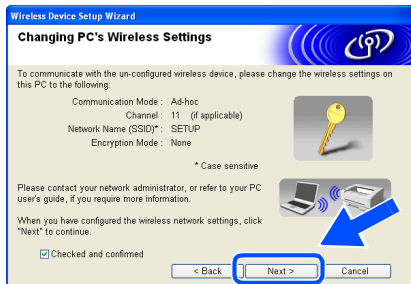

- If a message to restart your PC appears after the wireless settings have been changed, restart your PC and then go back to step 2 and continue with the install skipping steps 8 and 9.
- For Windows® XP SP2 users You can temporarily change the wireless settings on your PC, following the steps below:

- 1 Click **Start** and then **Control Panel**.
- 2 Click the **Network Connections** icon.
- 3 Select and right click **Wireless Network Connection**. Click **View Available Wireless Networks**.

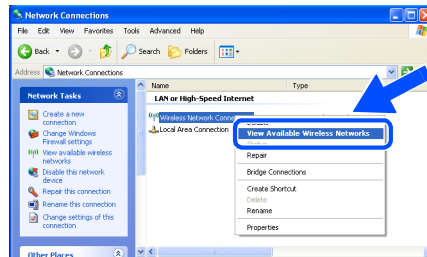

- 4 You can see the Brother wireless device (your printer) in the list. Select **SETUP** and click the **Connect**.

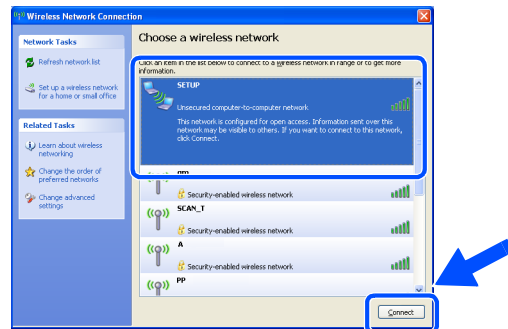

- 5 Check the **Wireless Network Connection** status. It may take a few minutes to change from 0.0.0.0 to 169.254.x.x IP address to be shown on screen (where x.x. are numbers between 1 and 254).

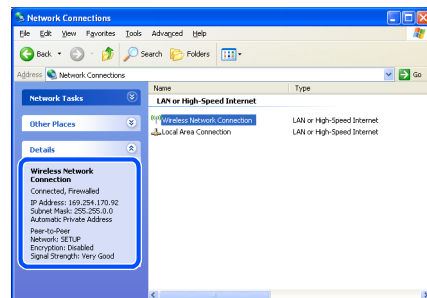

Note

- See the *User's Guide of your Network Interface or your PC* for how to change the wireless settings.



10 If more than one wireless printer is available on the network, the following list appears. If the list is blank, check if the access point and the printer are powered on, and then click **Refresh**. Choose the printer you wish to configure, and click **Next**.



Note

- The Default Node name of the printers network card is "BRW_XXXXXX" (where "XXXXXX" is the last six digits of the Ethernet address).
- If you are using Personal Firewall software (e.g. the Internet Connection Firewall available in Windows XP), temporarily disable it.



11 The wizard will search for wireless networks available from your printer. If more than one wireless network is available, the following list appears. Choose the wireless network you wish to associate the printer with, and then click **Next**.

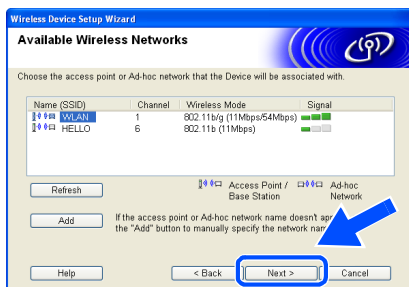

Note

- "SETUP" is the default SSID of the printer. Do not choose this SSID.
- If the list is blank, check that the printer is within range of the access point for wireless communication. Then, click **Refresh**.

- If your target wireless network does not appear on the list, you can manually add it by clicking the **Add** button. Follow the on-screen instructions for entering the **Name (SSID)** and the **Channel number**.

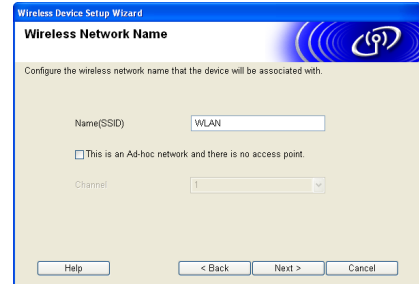

12 If your network is not configured for Authentication and Encryption, the following screen will appear. To continue installation, click **OK**. Go to Step 14.



13 If your network is configured for Authentication and Encryption the following screen will appear. When configuring your Brother wireless printer, you must ensure that it is configured to match the Authentication and Encryption settings of your existing wireless network. Choose the **Authentication Method** and **Encryption Mode** from the pull-downs in each setting box. Then enter the **Network Key** and click **Next**.



Note

- If you want to set more than one WEP key, click **Advanced**.
- If you want to configure LEAP security, see the Network User's Guide.

- If you do not know the Authentication or Encryption settings for your network contact your network administrator.

14 Click **Next**. The settings will be sent to your printer. The settings will remain unchanged if you click **Cancel**.

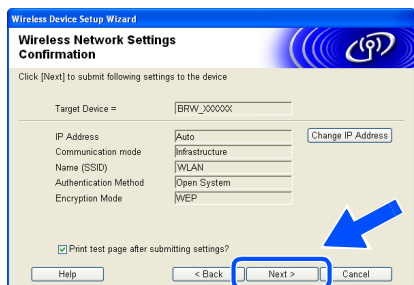

Note

If you want to manually enter the IP address settings of your printer, click **Change IP Address** and enter the necessary IP address settings for your network. After making your selection, click **Next** and the Wizard will search for available wireless networks.

15 Using the information you recorded in step 8, return the wireless settings of your computer back to their original settings. Check **Checked and confirmed**, and then click **Next**.

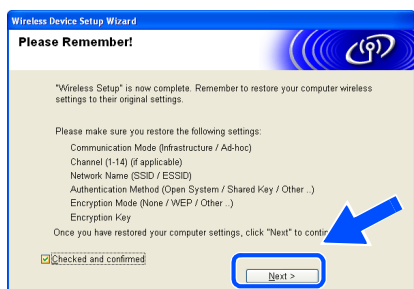

Installing the printer driver

⊘ Improper Setup

- **DO NOT** try to cancel any of the screens during this installation.
- If your wireless settings fail, an error message will appear during the installation of printer driver and the installation will be terminated. If you encounter this failure, please go to step 1 and setup the wireless connection again.

Note

Peer-to-peer print with NetBIOS is not available for Windows® XP x64 Edition.

16 The driver installation starts. When the License Agreement window appears, click **Yes** if you agree to the License Agreement.

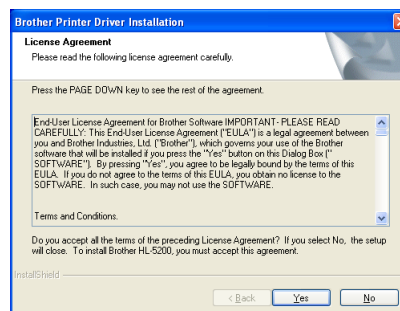

17 Choose **Standard Installation**, and then click **Next**.

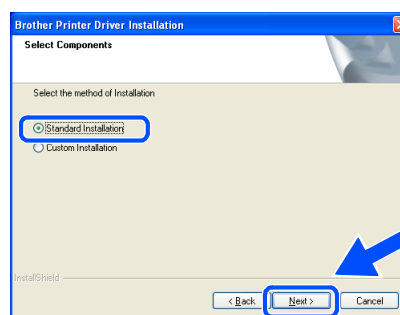

18 For LPR Users: Choose **Search the network for devices and choose from a list of discovered devices (Recommended)**. Or enter your printer's IP address or its node name. Click **Next**.

For NetBIOS Users: Choose **Search the network for devices and choose from a list of discovered devices (Recommended)**. Click **Next**.

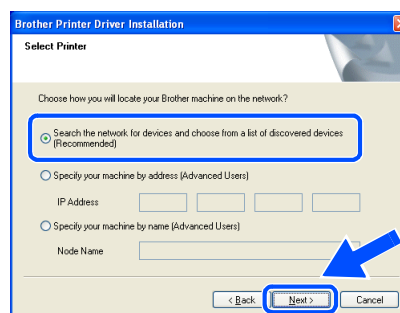

- 19** **For LPR Users:**
Choose your printer and choose **LPR (Recommended)**, and then click **Next**.



For Windows® 98/Me users, the setup will be complete after your PC has restarted.

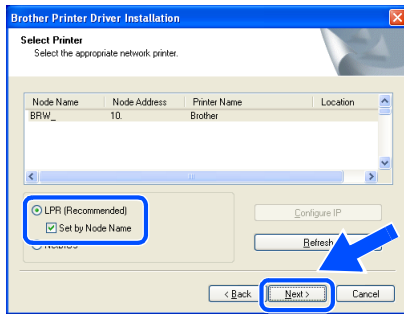

Note

If your printer takes a long time (about 1 minute) to appear on the list, click **Refresh**.

- For NetBIOS Users:**
Choose your printer and **NetBIOS**, and then click **Next**.

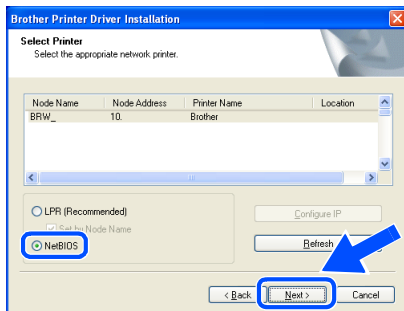

Note

If your printer takes a long time (about 1 minute) to appear on the list, click **Refresh**.

- 20** Click **Finish**.

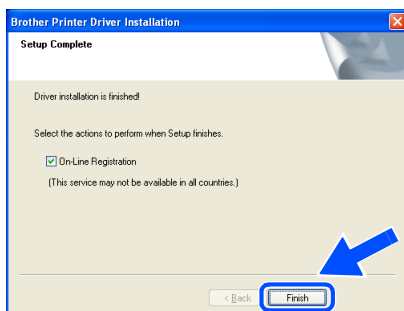

Note

- If you want to register your product on-line, check **On-Line Registration**.
- Turn your **Personal Firewall** back on.



For Windows NT® 4.0 and Windows® 2000/XP users, the setup is now complete.

For USB interface cable users

For Mac OS® X 10.2.4 or greater users

Connecting the printer to your Macintosh® and installing the driver

- 1 Click **Install Printer Driver** on the menu screen.



- 2 Click **USB cable users** and follow the on-screen instructions. Then, restart your Macintosh®.



- 3 Connect the USB interface cable to your Macintosh®, and then connect it to the printer.

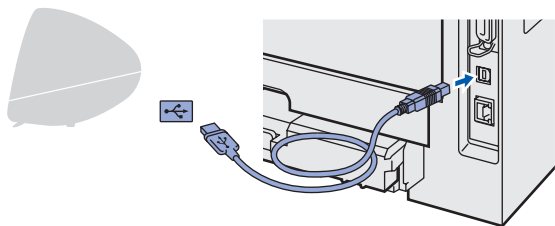

⊘ Improper Setup

DO NOT connect the printer to a USB port on a keyboard or a non-powered USB hub.

- 4 Make sure the printer power switch is on.



- 5 Click **Go**, then **Applications**.

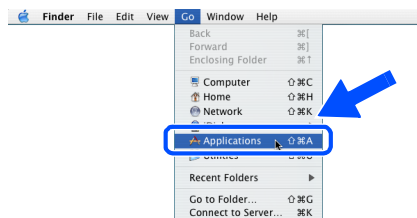

- 6 Double-click the **Utilities** folder.

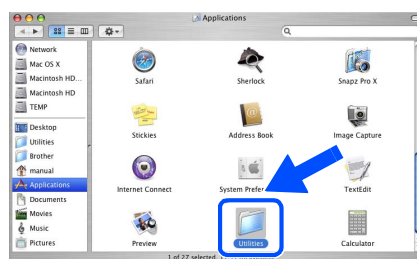

- 7 Double-click the **Printer Setup Utility** icon.

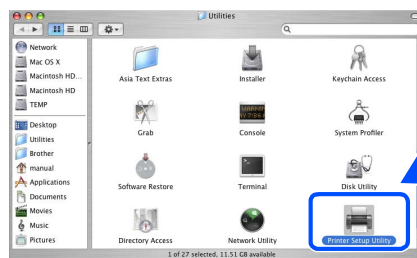

📝 Note

For Mac OS® X 10.2 users, open the **Print Center** icon.

- 8 Click **Add**.

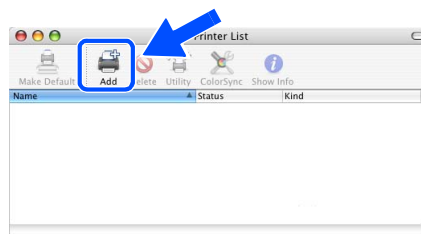

For Mac OS® 10.2.4 to 10.3 users:
Go to the next step.

For Mac OS® 10.4 or greater users:
Go to Step 10.

9 Choose **USB**.

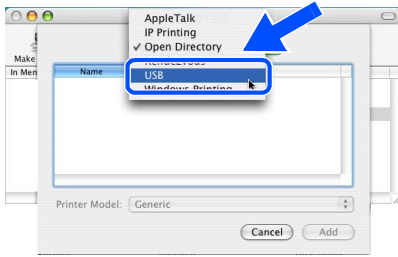

10 Choose the proper printer, and then click **Add**.
For Mac OS® 10.2 users:

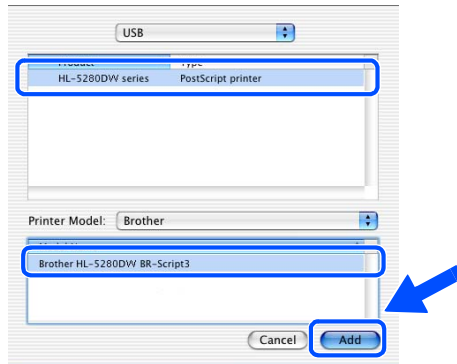

For Mac OS® 10.3 users:

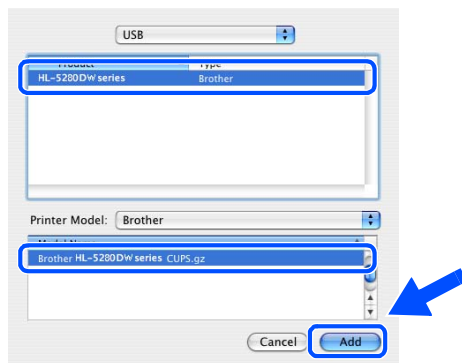

For Mac OS® 10.4 or greater users:

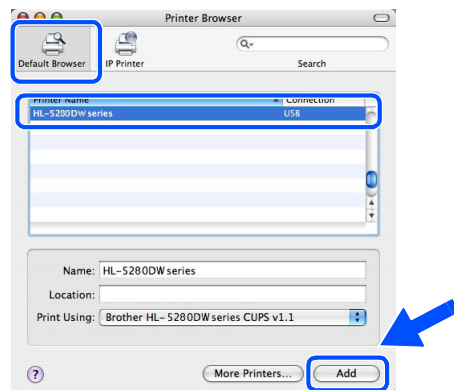

11 Click **Printer Setup Utility**, then **Quit Printer Setup Utility**.

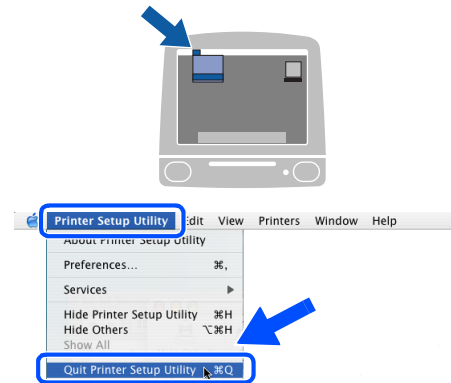

OK! The setup is now complete.

For Mac OS® 9.1 to 9.2 users

Connecting the printer to your Macintosh® and installing the driver

1 Put the supplied CD-ROM into your CD-ROM drive. Double-click the **Mac OS 9** folder.

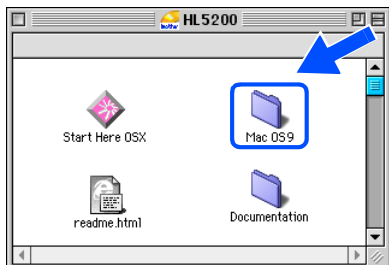

2 Double-click your language folder.

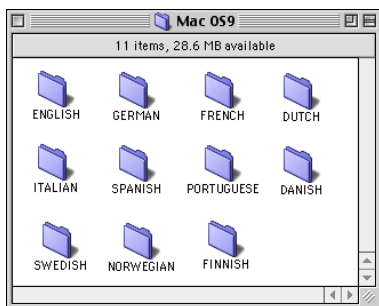

3 Double-click the **Printer Driver Installer** icon to install the printer driver. Follow the on-screen instructions and restart your Macintosh®.

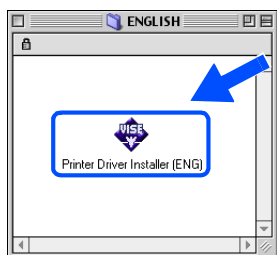

4 Connect the USB interface cable to your Macintosh®, and then connect it to the printer.

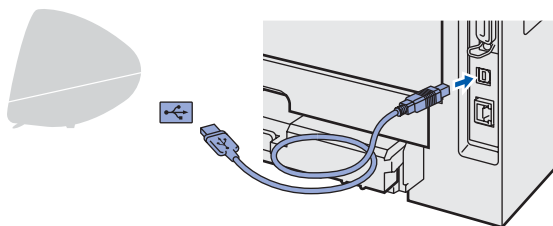

5 Make sure the printer power switch is on.



6 From the **Apple®** menu, click **Chooser**.

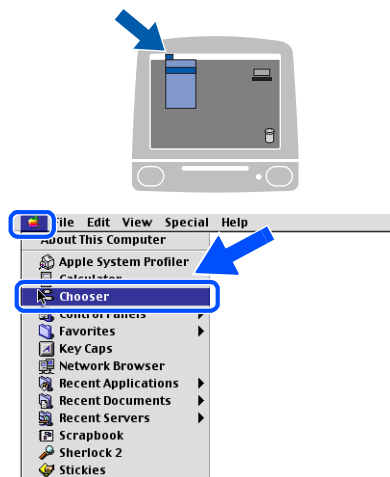

7 Click the **Brother Laser** icon. On the right side of the **Chooser**, choose the printer to which you want to print. Close the **Chooser**.

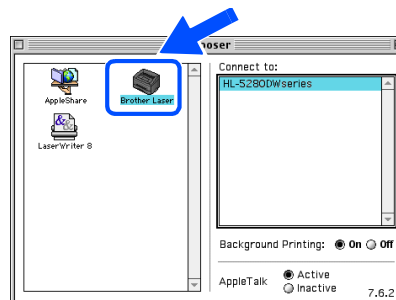

OK! The setup is now complete.

⊘ Improper Setup

DO NOT connect the printer to a USB port on a keyboard or a non-powered USB hub.

For wired network interface cable users

For Mac OS® X 10.2.4 or greater users

Connecting the printer to your Macintosh® and installing the driver

- 1** Click **Install Printer Driver** on the menu screen.

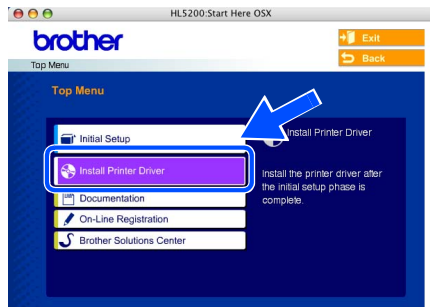

- 2** Click **Network cable users** and follow the on-screen instructions. Then, restart your Macintosh®.

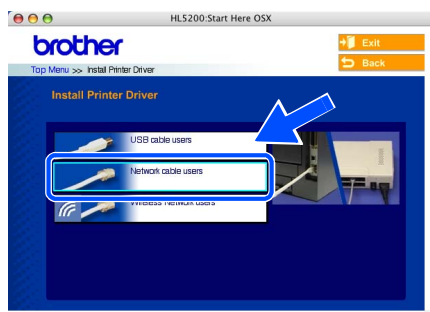

- 3** Turn off the printer power switch.



- 4** Connect the network interface cable to the printer, and then connect it to a free port on your hub.

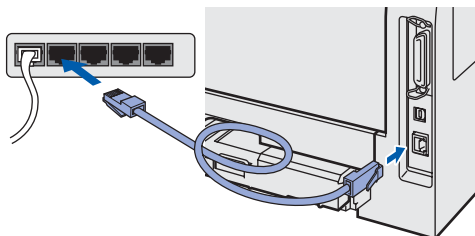

- 5** Turn on the printer power switch.



- 6** Click **Go**, then **Applications**.

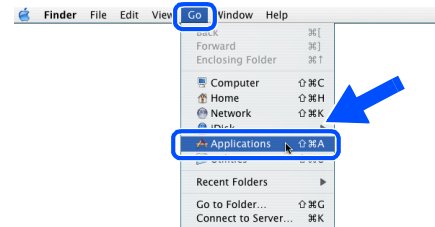

- 7** Double-click the **Utilities** folder.

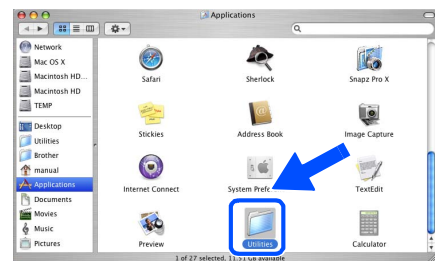

- 8** Double-click the **Printer Setup Utility** icon.

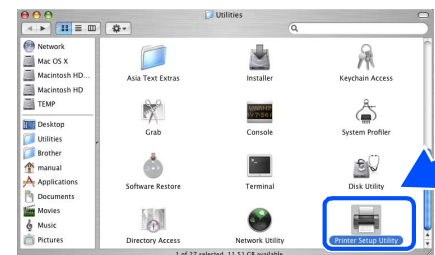
**Note**

For Mac OS® X 10.2 users, open the **Print Center** icon.

9 Click **Add**.

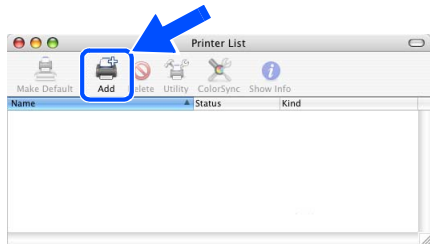

For Mac OS® 10.2.4 to 10.3 users:
Go to the next step.

For Mac OS® 10.4 or greater users:
Go to Step 12.

10 Make the following selection.

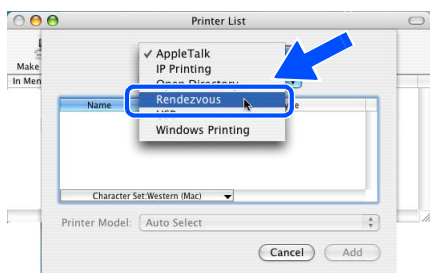

11 Choose **Brother HL-5280DW series**, and then click **Add**. Go to Step 13.

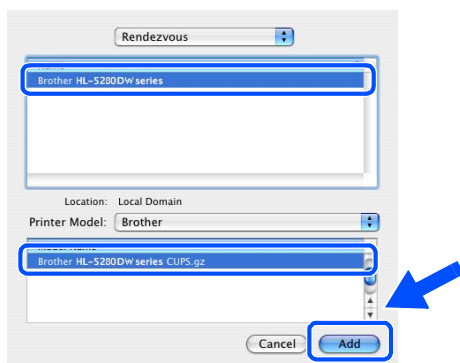

12 Choose **Brother HL-5280DW series**, and then click **Add**.

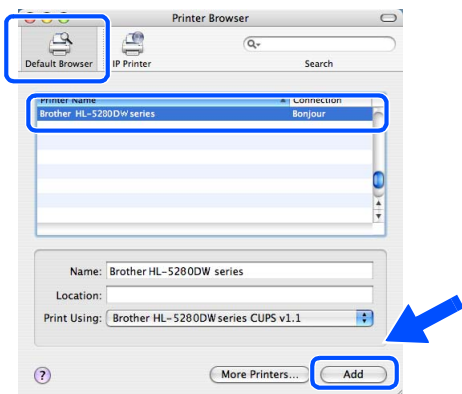

Note

If there is more than one of the same model printer (HL-5280DW) connected on your network, the Ethernet address (MAC address) will be displayed after the model name.

Network User's Guide Chapter 6 .

13 Click **Printer Setup Utility**, then **Quit Printer Setup Utility**.

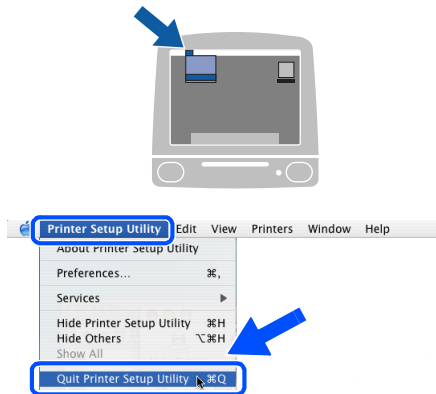

OK! The setup is now complete.

For Mac OS® 9.1 to 9.2 users

Connecting the printer to your Macintosh® and installing the driver

1 Turn off the printer power switch.



2 Connect the network interface cable to the printer, and then connect it to a free port on your hub.

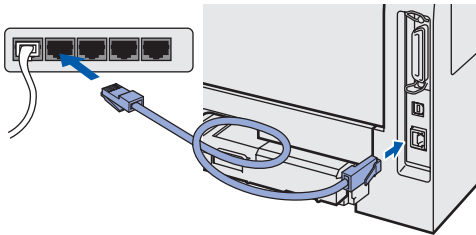

3 Turn on the printer power switch.



4 Put the supplied CD-ROM into your CD-ROM drive. Double-click the **Mac OS 9** folder.

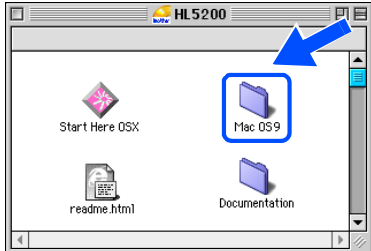

5 Double-click your language folder.



6 Double-click the **Printer Driver Installer** icon to install the printer driver. Follow the on-screen instructions.

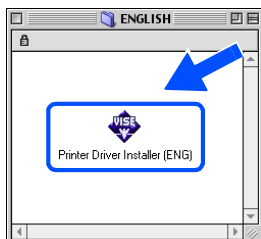

7 From the **Apple®** menu, click **Chooser**.

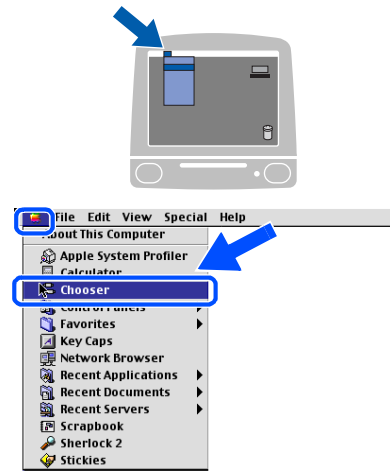

8 Click the **Brother Laser (IP)** icon, and then choose **BRN_XXXXXX** (where XXXXXX are the last six digits of the Ethernet address). Click **Setup...**

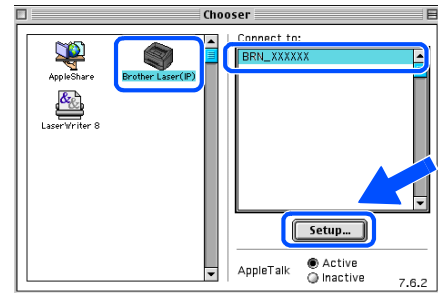

Network User's Guide Chapter 6.

9 Click **OK**. Close the **Chooser**.

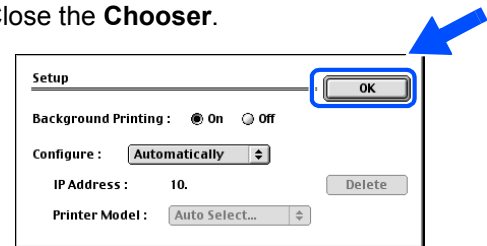

The setup is now complete.

For wireless network users (Mac OS® X 10.2.4 or greater users)

Connect your wireless printer and wireless network together: install the printer driver in infrastructure mode

First you must configure the wireless network settings of your printer to communicate with your network access point (router). After the printer is configured to communicate with your access point (router) computers on your network will have access to the printer. To use the printer from these computers, you will need to install the printer driver. The following steps will guide you through the configuration and installation process.

To achieve optimum results with normal every day document printing, place the Brother printer as close to the network access point (router) as possible with minimal obstructions. Large objects and walls between the two devices as well as interference from other electronic devices can affect the data transfer speed of your documents.

Due to these factors, wireless may not be the best method of connection for all types of documents and applications. If you are printing large files, such as photos or multi-page documents with mixed text and large graphics, you may want to consider choosing wired Ethernet for a faster data transfer, or USB for the fastest throughput speed.

Important

The following instructions will install your Brother printer in a wireless network environment in infrastructure mode, using a wireless router or access point that uses DHCP to assign IP addresses. If you want to setup your printer in any other wireless environment you can find instructions in the Network User's Guide on the CD-ROM.

Note

- *If you are going to connect the printer to your network, we recommend that you contact your system administrator prior to installation.*
- *Before installation, if you are using Personal Firewall software, disable it. Once you are sure that you can print, restart your Personal Firewall software.*



Infrastructure Mode

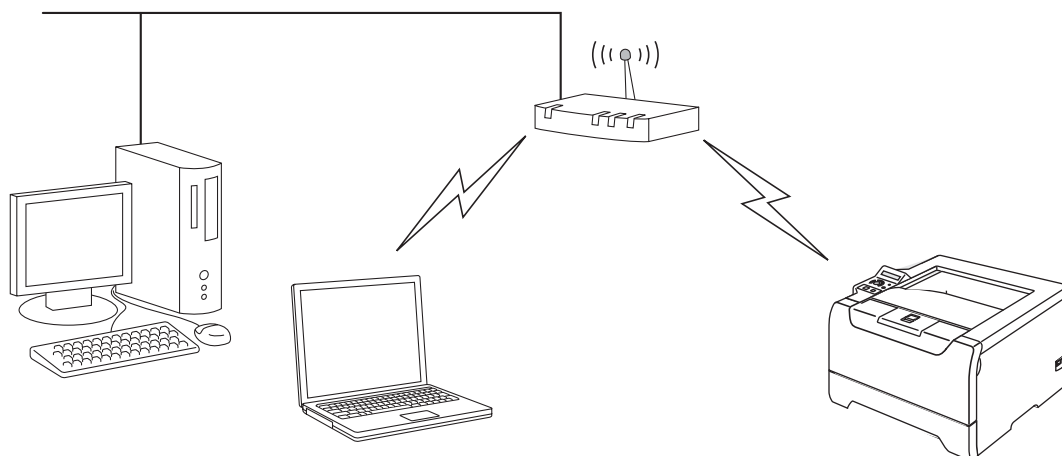

Confirm your network environment

The setup process will be different depending on your network environment.

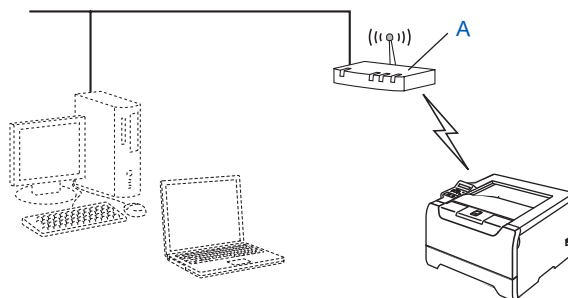
■ Installation using SecureEasySetup™.

If your wireless access point (A) supports SecureEasySetup™, you do not need to use a computer to configure the printer. The access point (router) and your printer can automatically negotiate using the SecureEasySetup™ procedure.

For instructions, see Chapter 3 in the Network User's Guide on the CD-ROM.

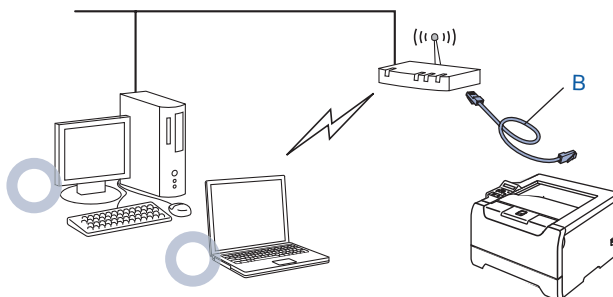
■ Installation temporarily using a network cable.

If there is an Ethernet Hub or Router in the same network as the wireless access point of your printer, you can temporarily connect the Hub or Router to the printer using an Ethernet cable (B), this is an easy way to configure the printer. You can then remotely configure the printer from a computer on the network.

For instructions, go to page 39.

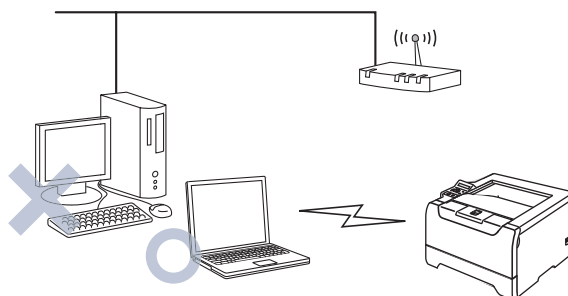
■ Installation using a wireless computer.

If a computer of yours has wireless capability, you will need to change the wireless settings of the computer to Ad-hoc mode so you can directly connect and configure the printer.

For instructions, go to page 43.

■ Installation using the control panel.

You can also configure the wireless settings of your printer, by using the control panel.

For instructions, see Chapter 3 in the Network User's Guide on the CD-ROM.

Installation temporarily using a network cable

⊘ Improper Setup

If you have previously configured the wireless settings of the printer, you must reset the NETWORK menu settings before you can configure the wireless settings again.

- 1 Press the + or - button to choose NETWORK. Press Set.
- 2 Press the + or - button to choose FACTORY RESET. Press Set.
- 3 Press Set again.

- 1 Make sure that the printer power switch is on.



- 2 Click **Install Printer Driver** on the menu screen.



- 3 Click **Wireless Network users**.



- 4 Choose **Wireless Setup and Driver Install**, and then click **Next**.



- 5 Choose **Automatic (Recommended)** and then click **Next**.



- 6 Choose **I'm able to temporarily connect my device to my access point with a network cable** and then click **Next**.



- 7 For configuration, you must temporarily connect your Brother wireless device (your printer) directly to a free port on your access point, hub or router using a network cable. When the following screen appears, insert the network cable to the access point and then to the printer. Click **Next**.

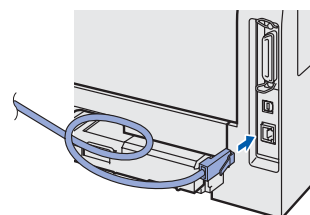

- 8** If more than one wireless printer is available on the network, a list of them will appear. If the list is blank, check that the access point and the printer are switched on, and then click **Refresh**.

Choose the printer you wish to configure, and click **Next**.



Note

- The Default Node name of the printers network card is "BRN_XXXXXX" (where "XXXXXX" is the last six digits of the Ethernet address).
- If you are using Personal Firewall software, temporarily disable it.



- 9** The wizard will search for wireless networks available from your printer. If more than one wireless network is available, the following list appears. Choose the wireless network you wish to associate the printer with, and then click **Next**.

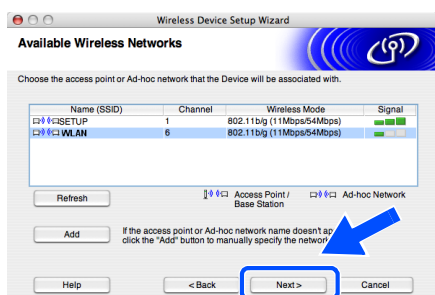

Note

- "SETUP" is the default SSID of the printer. Do not choose this SSID.
- If the list is blank, check that the printer is within range of the access point for wireless communication. Then, click **Refresh**.

- If your target wireless network does not appear on the list, you can manually add it by clicking the **Add** button. Follow the on-screen instructions for entering the **Name (SSID)** and the **Channel number**.

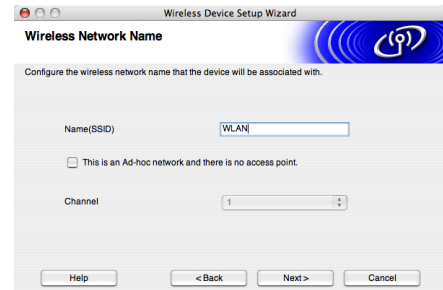

- 10** If your network is not configured for Authentication and Encryption, the following screen will appear. To continue installation, click **OK**. Go to Step **12**.



- 11** If your network is configured for Authentication and Encryption the following screen will appear. When configuring your Brother wireless printer, you must ensure that it is configured to match the Authentication and Encryption settings of your existing wireless network. Choose the **Authentication Method** and **Encryption Mode** from the pull-downs in each setting box. Then enter the **Network Key** and click **Next**.

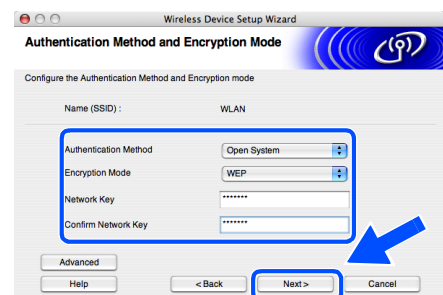

Note

- If you want to set more than one WEP key, click **Advanced**.
- If you want to configure LEAP security, see the *Network User's Guide*.
- If you do not know the Authentication or Encryption settings for your network contact your network administrator.

12 Click **Next**. The settings will be sent to your printer. The settings will remain unchanged if you click **Cancel**.

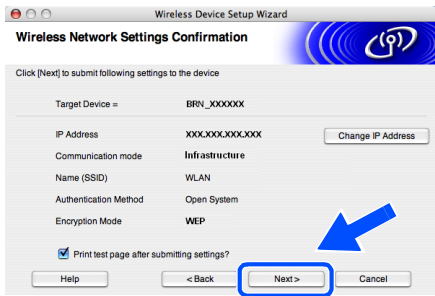

Note

If you want to manually enter the IP address settings of your printer, click **Change IP Address** and enter the necessary IP address settings for your network. After making your selection, click **Next** and the Wizard will search for available wireless networks.

13 Disconnect the network cable between your access point (hub or router) and the printer, and click **Next**.



Note

Wireless communication will not start until you have disconnected the network cable.

Installing the printer driver

⊘ Improper Setup

- DO NOT try to cancel any of the screens during this installation.
- If your wireless settings fail, an error message will appear during the installation of printer driver and the installation will be terminated. If you encounter this failure, please go to step 1 and setup the wireless connection again.

14 The driver installation starts. Follow the on-screen instructions and restart your Macintosh®.

15 Click **Go**, then **Applications**.

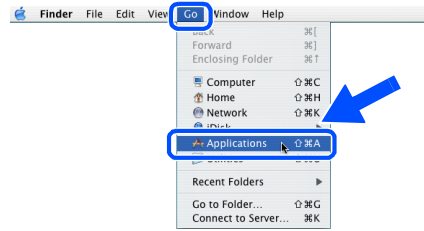

16 Double-click the **Utilities** folder.



17 Double-click the **Printer Setup Utility** icon.

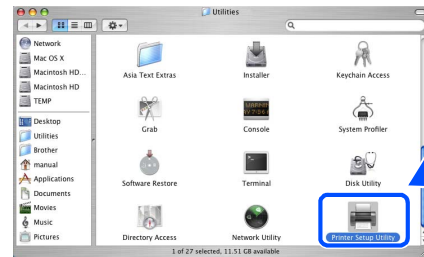

Note

For Mac OS® X 10.2 users, open the **Print Center** icon.

18 Click **Add**.

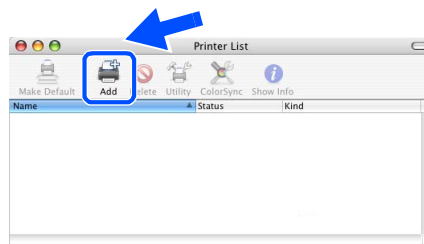

For Mac OS® 10.2.4 to 10.3 users:
Go to the next step.

For Mac OS® 10.4 or greater users:
Go to Step 21.

19 Make the following selection.

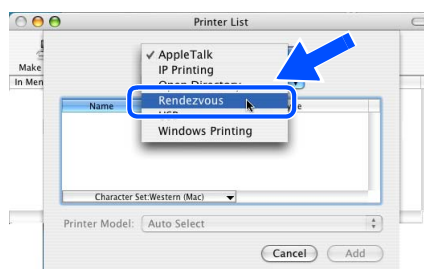

- 20** Choose **Brother HL-5280DW series**, and then click **Add**. Go to Step **22**.

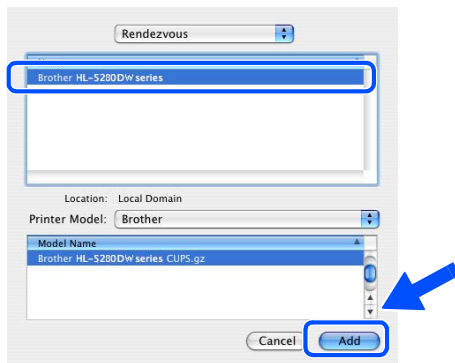

- 21** Choose **Brother HL-5280DW series**, and then click **Add**.

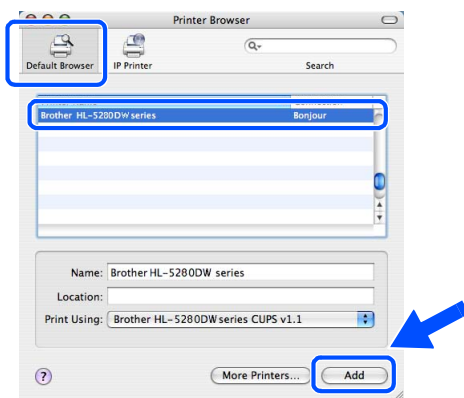

Note

If there is more than one of the same model printer (HL-5280DW) connected on your network, the Ethernet address (MAC address) will be displayed after the model name.



Network User's Guide Chapter 6 .

- 22** Click **Printer Setup Utility**, then **Quit Printer Setup Utility**.

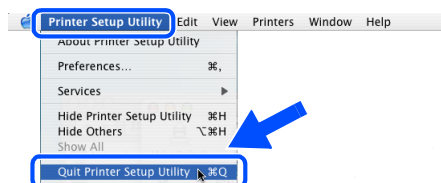
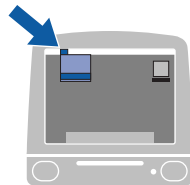

The setup is now complete.

Installation using a wireless computer

⊘ Improper Setup

If you have previously configured the wireless settings of the printer, you must reset the **NETWORK** menu settings before you can configure the wireless settings again.

- 1 Press the **+** or **-** button to choose **NETWORK**. Press **Set**.
- 2 Press the **+** or **-** button to choose **FACTORY RESET**. Press **Set**.
- 3 Press **Set** again.

- 1 Make sure that the printer power switch is on.



- 2 Click **Install Printer Driver** on the menu screen.

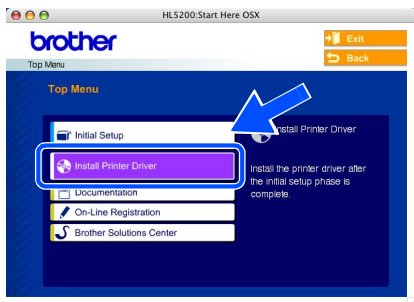

- 3 Click **Wireless Network users**.



- 4 Choose **Wireless Setup and Driver Install**, and then click **Next**.



- 5 Choose **Automatic (Recommended)** and then click **Next**.



- 6 Choose **I'm not able to connect my device to my access point with a network cable** and then click **Next**.



- 7 If you have chosen **This PC has wireless capability**, check **I am using an access point in infrastructure mode**, and then click **Next**.



If you choose **This PC uses a network cable to connect to the wireless network**, you must configure the wireless settings from the control panel. Click **Next** and follow the on-screen instructions to complete the setup. (See Chapter 3 in the Network User's Guide on the CD-ROM.) When finished, go to the driver installation in step **16** on page 46.



8 You need to temporarily change your computer's wireless settings. Please follow the on-screen instructions. Please make sure you take notes on all the settings such as SSID or channel of your computer. You will need them to return your computer back to its original wireless settings. Click **Next**.

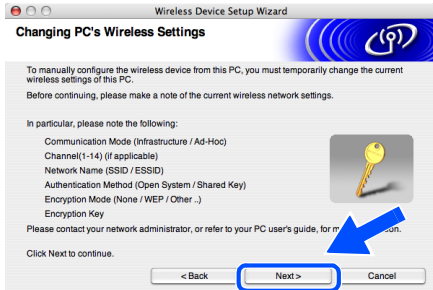

Item	Record the current wireless computer settings
Communication mode (Infrastructure / Ad-hoc)	
Channel (1-14)	
Network name (SSID / ESSID)	
Authentication method (Open system / Shared key / Other)	
Encryption (None / WEP / Other)	
Encryption key	

9 To communicate with the un-configured wireless printer, temporarily change the wireless settings on your computer to match printer's default settings shown on this screen. Check **Checked and confirmed**, and then click **Next**.



Note

- See the *User's Guide of your Network Interface or your computer* for how to change the wireless settings.
- You can temporarily change the wireless settings on your computer, following the steps below:

1 Click the AirPort status icon and select. **Open Internet Connect...**

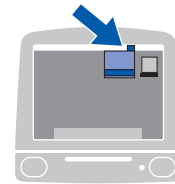

2 Click the **Network** tab to see the available wireless devices. You can see the Brother wireless print server in the **Network** option. Select **SETUP**.

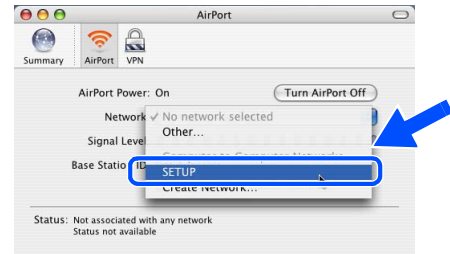

3 Your wireless network is connected successfully.



10 If more than one wireless printer is available on the network, the following list appears. If the list is blank, check if the access point and the printer are powered on, and then click **Refresh**. Choose the printer you wish to configure, and click **Next**.



• If your target wireless network does not appear on the list, you can manually add it by clicking the **Add** button. Follow the on-screen instructions for entering the **Name (SSID)** and the **Channel number**.

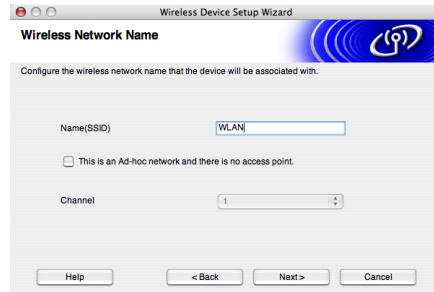

Note

- The Default Node name of the printers network card is "BRW_XXXXXX" (where "XXXXXX" is the last six digits of the Ethernet address).
- If you are using Personal Firewall software, temporarily disable it.

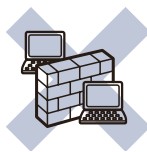

12 If your network is not configured for Authentication and Encryption, the following screen will appear. To continue installation, click **OK**. Go to Step 14.



11 The wizard will search for wireless networks available from your printer. If more than one wireless network is available, the following list appears. Choose the wireless network you wish to associate the printer with, and then click **Next**.

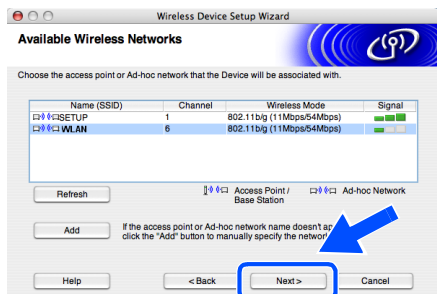

13 If your network is configured for Authentication and Encryption the following screen will appear. When configuring your Brother wireless printer, you must ensure that it is configured to match the Authentication and Encryption settings of your existing wireless network. Choose the **Authentication Method** and **Encryption Mode** from the pull-downs in each setting box. Then enter the **Network Key** and click **Next**.

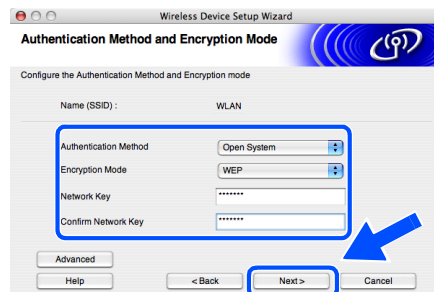

Note

- "SETUP" is the default SSID of the printer. Do not choose this SSID.
- If the list is blank, check that the printer is within range of the access point for wireless communication. Then, click **Refresh**.

Note

- If you want to set more than one WEP key, click **Advanced**.
- If you want to configure LEAP security, see the *Network User's Guide*.
- If you do not know the Authentication or Encryption settings for your network contact your network administrator.

14 Click **Next**. The settings will be sent to your printer. The settings will remain unchanged if you click **Cancel**.

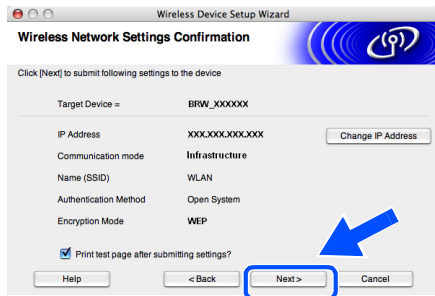

Note

If you want to manually enter the IP address settings of your printer, click **Change IP Address** and enter the necessary IP address settings for your network. After making your selection, click **Next** and the Wizard will search for available wireless networks.

15 Using the information you recorded in step 8, return the wireless settings of your computer back to their original settings. Check **Checked and confirmed**, and then click **Next**.



Installing the printer driver

Improper Setup

- DO NOT try to cancel any of the screens during this installation.
- If your wireless settings fail, an error message will appear during the installation of printer driver and the installation will be terminated. If you encounter this failure, please go to step 1 and setup the wireless connection again.

16 The driver installation starts. Follow the on-screen instructions and restart your Macintosh®.

17 Click **Go**, then **Applications**.

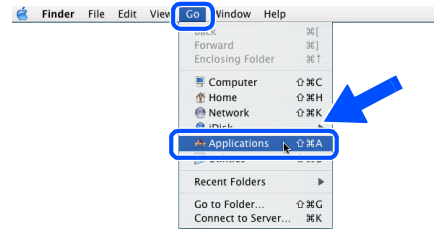

18 Double-click the **Utilities** folder.



19 Double-click the **Printer Setup Utility** icon.

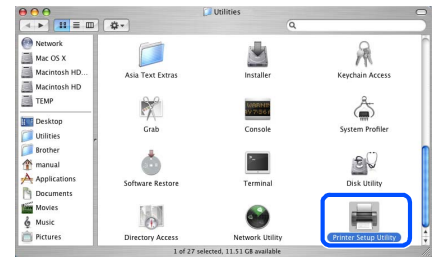

Note

For Mac OS® X 10.2 users, open the **Print Center** icon.

20 Click **Add**.

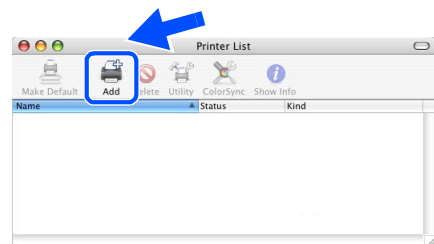

For Mac OS® 10.2.4 to 10.3 users:
Go to the next step.

For Mac OS® 10.4 or greater users:
Go to Step 23.

21 Make the following selection.

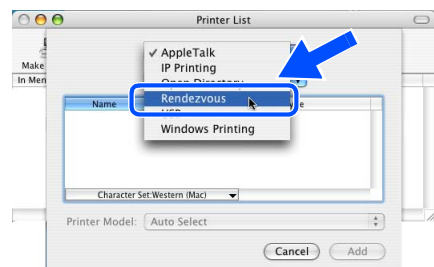

22 Choose **Brother HL-5280DW series**, and then click **Add**. Go to Step **24**.

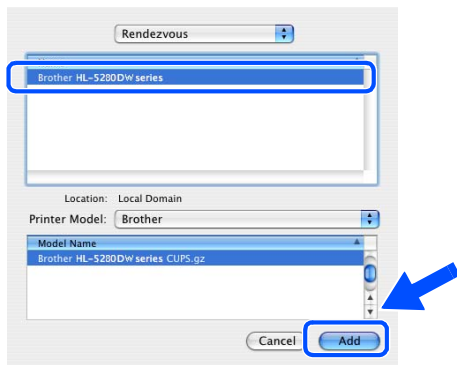

23 Choose **Brother HL-5280DW series**, and then click **Add**.

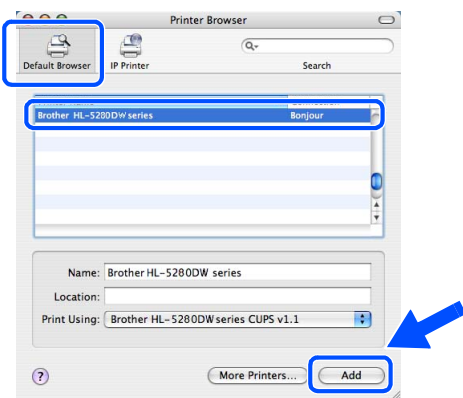

Note

If there is more than one of the same model printer (HL-5280DW) connected on your network, the Ethernet address (MAC address) will be displayed after the model name.



Network User's Guide Chapter 6 .

24 Click **Printer Setup Utility**, then **Quit Printer Setup Utility**.

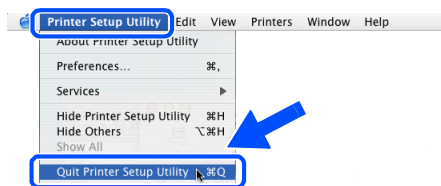
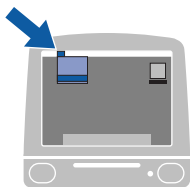

The setup is now complete.

BRAdmin Professional configuration utility (For Windows® users)

The BRAdmin Professional utility for Windows® is designed to manage your Brother network connected devices in a Local Area Network (LAN) environment. For more information on BRAdmin Professional, visit us at <http://solutions.brother.com>.

Installing the BRAdmin Professional configuration utility

- 1 Click **Install Other Drivers or Utilities** on the menu screen.



- 2 Click **BRAdmin Professional** and follow the on-screen instructions.

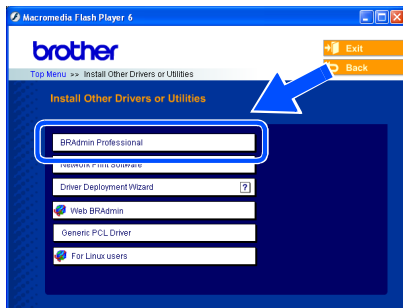

Note

The default password for the print server is 'access'. You can use BRAdmin Professional to change this password.

Setting your IP address, Subnet Mask and Gateway using BRAdmin Professional



Note

If you have a DHCP/BOOTP/RARP server in your network, you don't have to do the following operation. Because the print server will automatically obtain its IP address.

- 1 Start BRAdmin Professional, and choose **TCP/IP**.

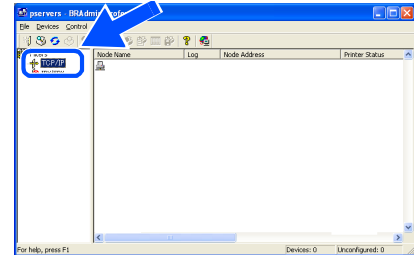

- 2 Click **Devices**, then **Search Active Devices**. BRAdmin searches for new devices automatically.

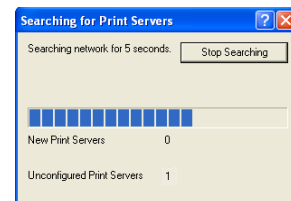
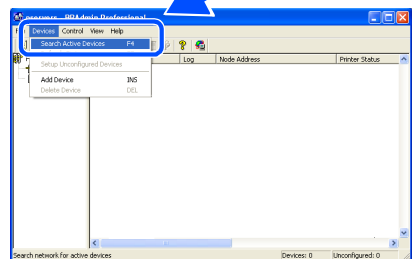

- 3 Double-click the new device.

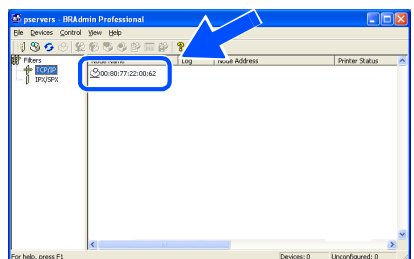

- 4 Enter the **IP Address**, **Subnet Mask** and **Gateway**, and then click **OK**.

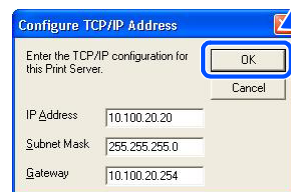

- 5 The address information will be saved to the printer.

BRAdmin Light configuration utility (For Mac OS[®] X users)

The Brother BRAdmin Light software is a Java™ application that is designed for the Apple Mac OS[®] X environment. It supports some of the features of the Windows BRAdmin Professional software. For example, using the BRAdmin Light software, you can change some network settings on Brother's network ready printers and multifunction devices.

The BRAdmin Light software will be installed automatically when you install the printer driver. If you have already installed the printer driver, you don't have to install it again.

For more information on BRAdmin Light, visit us at <http://solutions.brother.com>.

Setting your IP address, Subnet Mask and Gateway using BRAdmin Light

Note

- If you have a DHCP/BOOTP/RARP server in your network, you don't have to do the following operation. The print server will automatically obtain its own IP address. Make sure that version 1.4.1_07 or later of Java™ client software is installed on your computer.
- The default password for the print server is 'access'. You can use BRAdmin Light to change this password.

- 1 Double-click the **Macintosh HD** icon on your desktop.

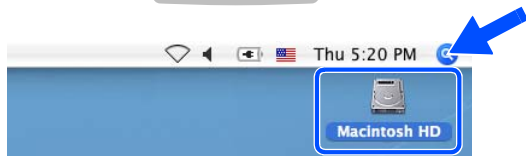
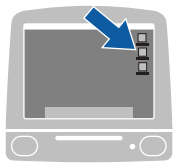

- 2 Choose **Library, Printers, Brother** and then **Utilities**.

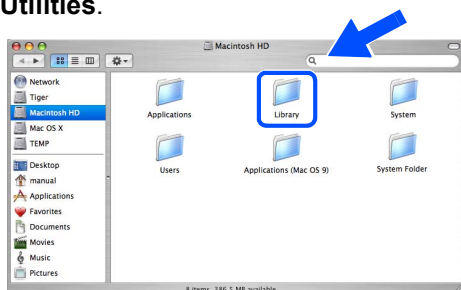

- 3 Double-click the **BRAdminLight.jar** file. Run the BRAdmin Light software. BRAdmin Light searches new devices automatically.



- 4 Double-click the new device.

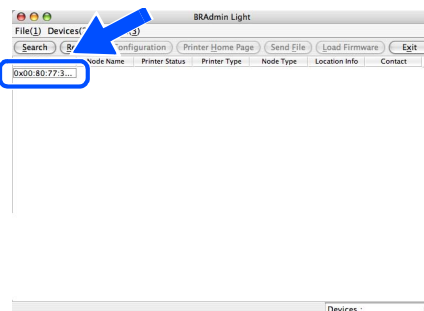

- 5 Enter the **IP Address, Subnet Mask and Gateway**, and then click **OK**.

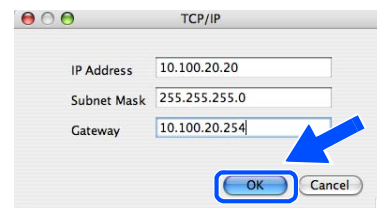

- 6 The address information will be saved to the printer.

Web browser

The Brother print server is equipped with a web server that allows you to monitor its status or change some of its configuration settings, using HTTP (Hyper Text Transfer Protocol).



Note

The User Name is '**admin**' and the default password is '**access**'. You can use a web browser to change this password.



See Chapter 2 of the Network User's Guide.

Network default settings

To restore all network settings of the internal print server to default, follow the steps below.

- 1 Press the + or - button to choose NETWORK. Press **Set**.

NETWORK

- 2 Press the + or - button to choose FACTORY RESET. Press **Set**.

FACTORY RESET

- 3 Press **Set** again.

OK?

Print the Printer Settings Page

The Printer Settings Page lists all the current printer settings, including network settings. To print the printer settings page:

- 1 Press the + button to choose INFORMATION. Press **Set**.

INFORMATION

- 2 Press **Set** again.

PRINT SETTINGS

- 3 Press **Set** again to print the Printer Settings Page.

Options

The printer has the following optional accessories. You can expand the capabilities of the printer by adding these items.

 See Chapter 5 of the User's Guide.

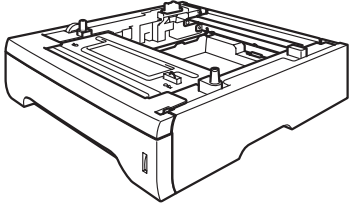
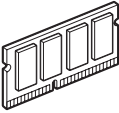
Lower Tray Unit	DIMM Memory
<p style="text-align: center;">LT-5300</p>	
<div style="text-align: center;">  </div> <p>Second or third lower paper tray unit can hold up to 250 sheets of paper. When both trays are installed, the printer expands total input capacity up to 800 sheets.</p>	<div style="text-align: center;">  </div> <p>You can expand the memory by installing the (144-pin DIMM) memory module.</p>

Consumables

When the time comes to replace consumable items, the following messages will appear on the LCD.

TONER LOW

TONER LIFE END

DRUM NEAR END

For more information about the consumables for your printer, visit us at <http://solutions.brother.com> or contact your local Brother reseller.

 See Chapter 6 of the User's Guide.

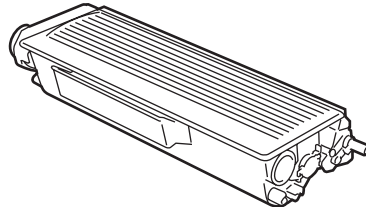
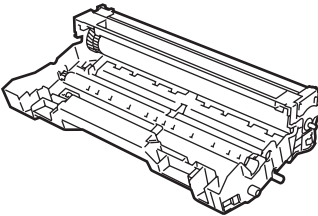
Toner Cartridge	Drum Unit
<div style="text-align: center;">  </div>	<div style="text-align: center;">  </div>

Shipment of the printer

If for any reason you must ship your printer, carefully package the printer to avoid any damage during transit. We recommend that you save and use the original packaging. The printer should also be adequately insured with the carrier.

! Caution

When shipping the printer, the DRUM UNIT and TONER CARTRIDGE assembly must be removed from the printer and put in a plastic bag. Failure to remove the unit and put it in a plastic bag before shipping may cause severe damage to the printer and may VOID THE WARRANTY.

- 1 Turn off the printer power switch, and then unplug the AC power cord.

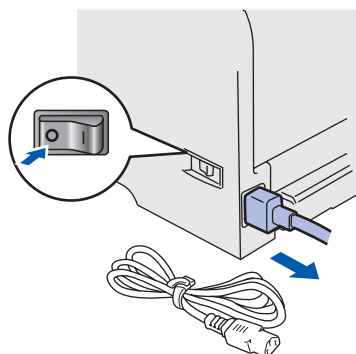

- 2 Remove the drum unit and toner cartridge assembly. Put it in a plastic bag and seal the bag completely.

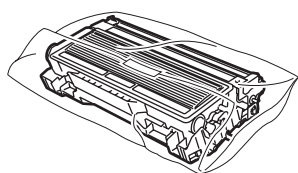

- 3 Repack the printer.

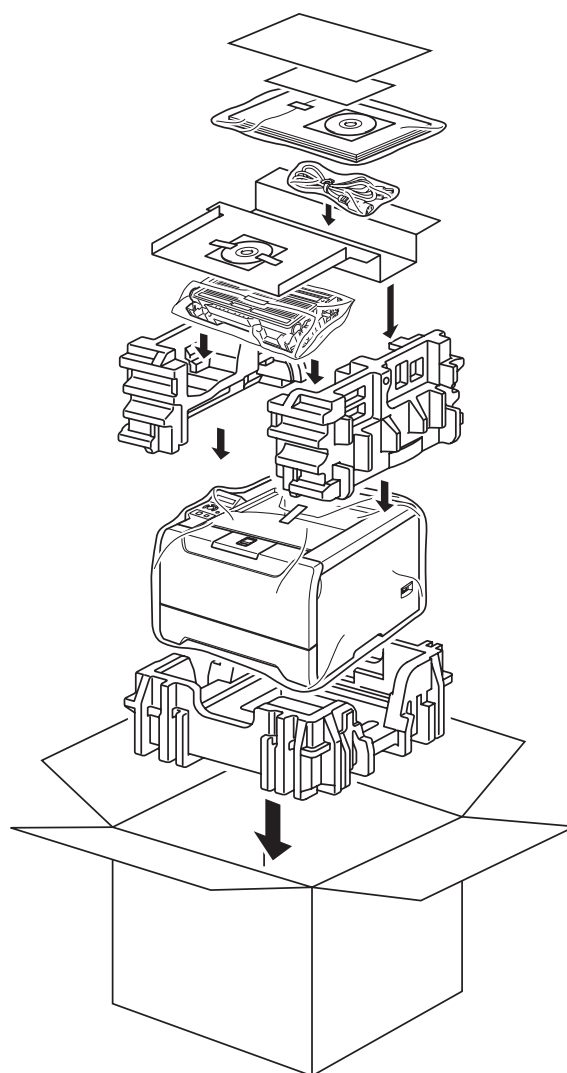

Trademarks

The Brother logo is a registered trademark of Brother Industries, Ltd.

Apple, the Apple Logo, Macintosh and TrueType are registered trademarks of Apple Computer, Inc in the United States and other countries.

Epson is a registered trademark and FX-80 and FX-850 are trademarks of Seiko Epson Corporation.

Hewlett Packard is a registered trademark and HP LaserJet 6P, 6L, 5P, 5L, 4, 4L 4P, III, IIIP, II, and IIP are trademarks of Hewlett-Packard Company.

IBM, IBM PC, and Proprinter are registered trademarks of International Business Machines Corporation.

Microsoft, MS-DOS, Windows and Windows NT are registered trademarks of Microsoft Corporation in the U.S. and other countries.

PostScript and PostScript 3 are trademarks of Adobe Systems Incorporated.

Java and all Java-based trademarks and logos are trademarks or registered trademarks of Sun Microsystems, Inc. in the United States and other countries.

BROADCOM, SecureEasySetup and the SecureEasySetup logo are trademarks or registered trademarks of Broadcom Corporation.

Wi-Fi is a registered trademark and WPA is a trademark of the Wi-Fi Alliance.

All other terms and brand and product names mentioned in this Quick Setup Guide are registered trademarks of their respective companies.

Compilation and Publication

This manual has been compiled and published, under the supervision of Brother Industries Ltd., covering the latest product descriptions and specifications.

The contents of this manual and the specifications of this product are subject to change without notice.

Brother reserves the right to make changes without notice in the specifications and materials contained herein and shall not be responsible for any damages (including consequential) caused by reliance on the materials presented, including but not limited to typographical and other errors relating to the publication.

This product is designed for use in a professional environment.

brother®



LM6475001②

EN

Printed in China

Free Manuals Download Website

<http://myh66.com>

<http://usermanuals.us>

<http://www.somanuals.com>

<http://www.4manuals.cc>

<http://www.manual-lib.com>

<http://www.404manual.com>

<http://www.luxmanual.com>

<http://aubethermostatmanual.com>

Golf course search by state

<http://golfingnear.com>

Email search by domain

<http://emailbydomain.com>

Auto manuals search

<http://auto.somanuals.com>

TV manuals search

<http://tv.somanuals.com>