



Built-in oven HB.43S..., HB.33B..., HEV33B..., HB.23.....



BOSCH

[en] Instruction manual

en Table of contents

Important safety information	2	Unhooking and hanging the oven door	11
Causes of damage	4	Removing and installing the door panels	12
Your new oven	4	Troubleshooting	13
Control panel	4	Troubleshooting table	13
Function control knob	5	Changing the oven bulb	13
Control buttons and display panel	5	Protective glass panels.....	13
Temperature control knob.....	5	After-sales service	14
Inside the oven	5	E number and FD number	14
Your accessories	6	Energy and environment tips	14
inserting the accessories	6	Saving energy.....	14
Special accessories	6	Environmentally-friendly disposal of waste	14
Before using the oven for the first time	7	Tested for you in our cooking studio	14
Setting the time	7	Cakes and pastries	14
Heating the oven.....	7	Suggestions and practical advice for baking.....	16
Cleaning the accessories.....	7	Meat, poultry, fish.....	17
Programming the oven	7	Tips for roasting and grilling.....	19
Type of heating and temperature	7	Au gratin, soufflés, toast.....	19
Rapid heating	7	Ready-made products.....	20
Setting the time functions	8	Special dishes	21
Timer	8	Defrosting.....	21
Cooking time	8	Drying	21
End time.....	9	Jam making	21
Time.....	9	Acrylamide in food	22
Childproof lock	9	Test dishes	23
Changing the basic settings	10	Baking	23
Care and cleaning	10	Grilling	23
Cleaning products	10		
Light.....	11		
Removing the grill heating element.....	11		
Removing and refitting the wire shelves or left and right hand side rails	11		

Additional information on products, accessories, replacement parts and services can be found at www.bosch-home.com and in the online shop www.bosch-eshop.com

Important safety information

Read these instructions carefully. Only then will you be able to operate your appliance safely and correctly. Retain the instruction manual and installation instructions for future use or for subsequent owners.

This appliance is only intended to be fully fitted in a kitchen. Observe the special installation instructions.

Check the appliance for damage after unpacking it. Do not connect the appliance if it has been damaged in transport.

Only a licensed professional may connect appliances without plugs. Damage caused by incorrect connection is not covered under warranty.

This appliance is intended for domestic use only. The appliance must only be used for the preparation of food and drink. The appliance must be supervised during operation. Only use this appliance indoors.

This appliance may be used by children over the age of 8 years old and by persons with reduced physical, sensory or mental capacity or by persons with a lack of experience or knowledge if they are supervised or are instructed by a person responsible for their safety how to use the appliance safely and have understood the associated hazards.

Children must not play with the appliance. Children must not clean the appliance or carry out general maintenance unless they are at least 8 years old and are being supervised.

Keep children below the age of 8 years old at a safe distance from the appliance and power cable.

Always slide accessories into the cooking compartment correctly. See "*Description of accessories*" in the instruction manual.

Risk of fire!

- Combustible items stored in the cooking compartment may catch fire. Never store combustible items in the cooking compartment. Never open the appliance door if there is smoke inside. Switch off the appliance and unplug it from the mains or switch off the circuit breaker in the fuse box.
- A draught is created when the appliance door is opened. Greaseproof paper may come into contact with the heating element and catch fire. Do not place greaseproof paper loosely over accessories during preheating. Always weight down the greaseproof paper with a dish or a baking tin. Only cover the surface required with greaseproof paper. Greaseproof paper must not protrude over the accessories.

Risk of burns!

- The appliance becomes very hot. Never touch the interior surfaces of the cooking compartment or the heating elements. Always allow the appliance to cool down. Keep children at a safe distance.
- Accessories and ovenware become very hot. Always use oven gloves to remove accessories or ovenware from the cooking compartment.
- Alcoholic vapours may catch fire in the hot cooking compartment. Never prepare food containing large quantities of drinks with a high alcohol content. Only use small quantities of drinks with a high alcohol content. Open the appliance door with care.

Risk of scalding!

- The accessible parts become hot during operation. Never touch the hot parts. Keep children at a safe distance.
- When you open the appliance door, hot steam may escape. Open the appliance door with care. Keep children at a safe distance.
- Water in a hot cooking compartment may create hot steam. Never pour water into the hot cooking compartment.

Risk of injury!

Scratched glass in the appliance door may develop into a crack. Do not use a glass scraper, or sharp or abrasive cleaning aids or detergents.

Risk of electric shock!

- Incorrect repairs are dangerous. Repairs may only be carried out by one of our trained after-sales engineers. If the appliance is faulty, unplug the mains plug or switch off the fuse in the fuse box. Contact the after-sales service.
- The cable insulation on electrical appliances may melt when touching hot parts of the appliance. Never bring electrical appliance cables into contact with hot parts of the appliance.
- Penetrating moisture may cause an electric shock. Do not use any high-pressure cleaners or steam cleaners.
- When replacing the cooking compartment bulb, the bulb socket contacts are live. Before replacing the bulb, unplug the appliance from the mains or switch off the circuit breaker in the fuse box.
- A defective appliance may cause electric shock. Never switch on a defective appliance. Unplug the appliance from the mains or switch off the circuit breaker in the fuse box. Contact the after-sales service.

Risk of burns!

The appliance will become very hot on the outside during the cleaning function. Never touch the appliance door. Allow the appliance to cool down. Keep children at a safe distance.

Causes of damage

Caution!

- Accessories, foil, greaseproof paper or ovenware on the cooking compartment floor: do not place accessories on the cooking compartment floor. Do not cover the cooking compartment floor with any sort of foil or greaseproof paper. Do not place ovenware on the cooking compartment floor if a temperature of over 50 °C has been set. This will cause heat to accumulate. The baking and roasting times will no longer be correct and the enamel will be damaged.
- Water in a hot cooking compartment: do not pour water into the cooking compartment when it is hot. This will cause steam. The temperature change can cause damage to the enamel.
- Moist food: do not store moist food in the cooking compartment when it is closed for prolonged periods. This will damage the enamel.
- Fruit juice: when baking particularly juicy fruit pies, do not pack the baking tray too generously. Fruit juice dripping from the baking tray leaves stains that cannot be removed. If possible, use the deeper universal pan.
- Cooling with the appliance door open: only allow the cooking compartment to cool when it is closed. Even if the appliance door is only open a little, front panels of adjacent units could be damaged over time.
- Very dirty door seal: If the door seal is very dirty, the appliance door will no longer close properly when the appliance is in use. The fronts of adjacent units could be damaged. Always keep the door seal clean.
- Appliance door as a seat, shelf or worktop: Do not sit on the appliance door, or place or hang anything on it. Do not place any cookware or accessories on the appliance door.
- Inserting accessories: depending on the appliance model, accessories can scratch the door panel when closing the appliance door. Always insert the accessories into the cooking compartment as far as they will go.
- Carrying the appliance: do not carry or hold the appliance by the door handle. The door handle cannot support the weight of the appliance and could break.

Your new oven

We will now describe your new oven. This chapter explains the functions of the control panel and its individual elements. Information is also provided about the oven's accessories and internal components.

Control panel

Below is a general overview of the control panel. The display panel cannot show all the symbols at the same time. Elements may vary according to the model.

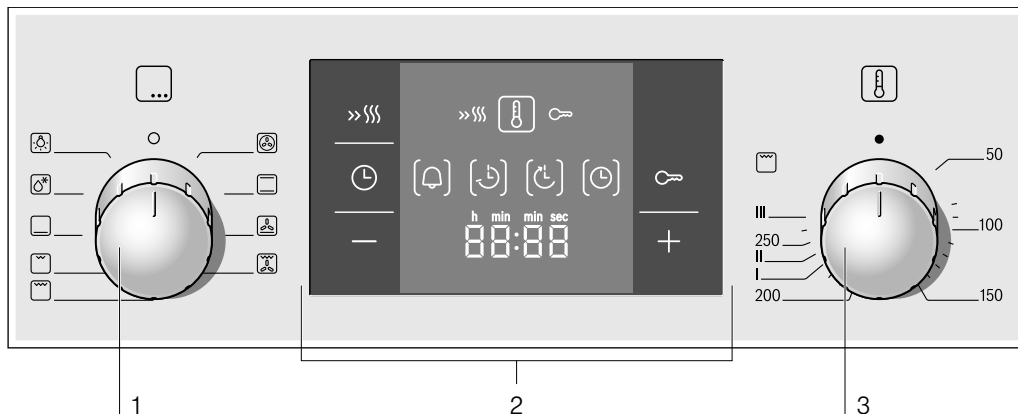

Use

1	Function control knob
2	Control buttons and display panel
3	Temperature control knob

Retractable control knobs









In some ovens, the control knobs are retractable. The control knob is retracted or returned by pressing it when at the zero setting.

Buttons

There are sensors under each button. Do not press hard on the buttons. Only press the relevant symbol.

Function control knob

The function control knob is used to select the type of heating.







Setting	Use
○ Zero setting	The oven is off.
 3D Hot air*	For cakes and pastries. These can be baked on three levels. A fan located on the rear wall of the oven disperses the heat evenly.
 Top and bottom heating*	For cakes, au gratin dishes, and lean meat roasts, e.g. veal or game, on one level. The heat is provided by the bottom and top heating elements.
 Pizza function	Quick preparation of frozen foods without pre-heating, e.g., pizza, chips or puff pastry. The heat comes from the bottom element and the fan on the rear wall.
 Grill with hot air	For roasting joints of meat, poultry and fish. The grill heating element and the fan switch on and off alternately. The fan circulates the heat generated by the grill around the food.
 Large surface grill	For grilling steaks, sausages, fish and toasting bread. The entire surface below the grill heating element is heated.
 Grill, small surface area	For grilling a small number of steaks or sausages or small amounts of fish, and toasting bread. Only the central area of the grill heating element heats up.
 Bottom heating	Confits, baking and cooking au gratin. The heat comes from the bottom heating element.
 Defrosting	Defrosting, e.g. meat, poultry, bread and cakes. The fan circulates the hot air around the food.
 Light	For turning on the oven light.

* Type of heating used to determine the appliance's energy efficiency rating according to EN60350.

Once a type of heating has been selected the oven light is turned on.

Control buttons and display panel



The buttons are used to set different additional functions. The set values are shown on the display panel.



Button	Use
»»» Rapid heating	Heats the oven particularly quickly.
 Time functions	Select the timer  , the cooking time  , the end time  and the time  .
 Childproof lock	Blocks and unblocks the control panel.
- Minus	Reduces programmed values.
+ Plus	Increases programmed values.

The symbol for the time function is in brackets [] on the display panel.

Temperature control knob

The temperature control knob is used to select the temperature or the grill power level.

Setting	Meaning
● Zero setting	The oven does not heat up.
50-270 Temperature range	The oven's temperature in °C.
I,II and III. Grill power	The power levels of the small surface grill  and large surface grill  . I = level 1, low II = level 2, medium III = level 3, high

When the oven is heating, the  symbol lights up on the display panel. This light goes off when heating is paused. The symbol does not come on with the light function  or the defrost function .

Note: If grilling for more than 15 minutes, turn the temperature control knob to the low setting.

Inside the oven

There is a light inside the oven. A fan prevents the oven from overheating.

Fan

The fan can be turned on and off as necessary. The hot air escapes through the top of the door. Warning! Do not cover the vent. The oven could overheat.

The fan remains on for a certain length of time after the oven has been switched off so that it can cool down more quickly.

Light

The oven light remains on while the oven is working. However, the light can be turned on without the oven being on by setting the function control knob to .

Your accessories

The accessories supplied with your appliance are suitable for making many meals. Ensure that you always insert the accessories into the cooking compartment the right way round.

There is also a selection of optional accessories, with which you can improve on some of your favourite dishes, or simply to make working with your oven more convenient.

inserting the accessories

The accessories can be placed inside the oven on 5 different levels. Always insert them as far as possible so that the accessories do not touch the door glass.

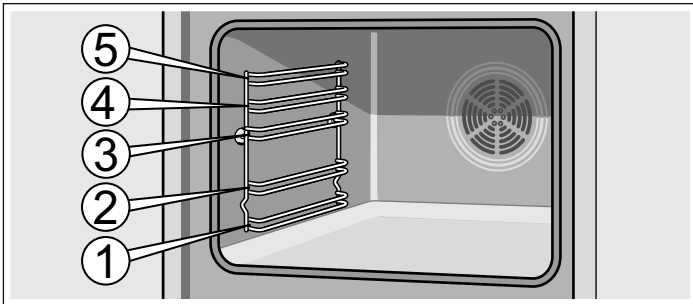

The accessories can be removed halfway until they are secured. This makes it easy to remove food.

When inserting an accessory in the oven, make sure the curvature is at the rear. This is the only way to ensure it fits perfectly.

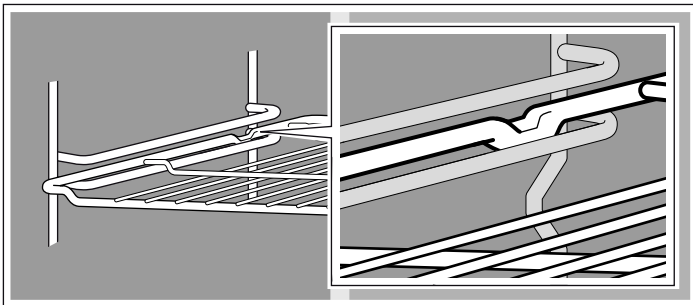

Depending on the equipment, if the appliance has guide rails, these will interlock slightly when fully removed. This means the accessory can be easily inserted. To unlock, reinsert the guide rails in the oven exerting slight pressure.

Note: Accessories may deform as they heat up. This deformation will disappear when they cool. This does not affect the normal operation.

Your oven is supplied with only some of the following accessories.

Accessories may be purchased from the Technical Assistance Service, from specialist retailers or on the Internet. Enter the HEZ number.



Wire shelf

For cookware, baking tins, roasts, grilled items and frozen meals.

Insert the wire shelf with the open end facing the oven door and the curvature downwards .



Flat enamel oven tray

For cakes, pastries and biscuits.

Place the tray in the oven with its raised lip facing the door.



Universal deep enamel tray

For juicy cakes, pastries, frozen meals and large joints for roasting. This can also be used as a tray to collect the fat when roasting directly on the wire shelf.

Place the tray in the oven with its raised lip facing the door.

Special accessories

Accessories may be purchased from the Technical Assistance Service or from specialist retailers. There is a wide range of accessories available for the oven in our catalogues and on the Internet. Ordering online and the availability of special accessories changes from country to country. Consult your purchase documentation.

Not all of the special accessories are suitable for all appliances. When purchasing, always give the exact name (E-Nr.) of your appliance.

Special accessories	HEZ number	Use
Flat enamel oven tray	HEZ361000	For cakes, pastries and biscuits.
Universal deep enamel tray	HEZ362000	For juicy pies, pastries, frozen meals and large joints for roasting. This can also be used as a tray to collect the fat when roasting directly on the wire shelf.
Wire shelf	HEZ364000	For cookware, baking tins, roasts, items placed directly on a wire shelf and frozen meals.
Pizza tray	HEZ317000	Ideal for pizza, frozen foods, or large round cakes. The pizza tray can be used instead of the universal deep tray. Place the tray on the wire shelf and follow the indications in the tables.
Glass casserole dish	HEZ915001	The glass casserole dish is ideal for preparing stews and foods that need browning in the oven. It is especially suitable for automatic programmes and automatic roasting.
Triple removable guide rails	HEZ368301	The triple guide rails at heights 1, 2 and 3 ensure that accessories can be fully removed without them tipping over.

Before using the oven for the first time

In this section, you can find out what you must do before using your oven to prepare food for the first time. First read the section on *Safety information*.

Setting the time

Once the oven has been connected, the ⏰ symbol and four zeros are shown flashing on the display panel. Set the time.

1. Press the ⏰ button.

The display shows the time **12:00**.

2. Set the time with the buttons + or -.

The programmed time is displayed after a few seconds.

Heating the oven

To remove the "new" smell, heat the oven empty with the door closed. The most effective option is to heat the oven for one hour with the top and bottom heating elements  set at 240 °C. Check that no packaging has been left inside the oven.

1. Select top and bottom heating  using the function control knob.
2. Select 240 °C with the temperature control knob.

Turn the oven off after one hour. To do this, turn the function control knob to zero.

Cleaning the accessories

Before using the accessories for the first time, clean them thoroughly using a cloth, hot water and a little soap.

Programming the oven

There are different ways to programme the oven. Programming the type of heating, temperature or grill power. The oven can be programmed with the cooking time (duration) and the end time for each dish. For more information, see the chapter *Setting the time functions*.

Type of heating and temperature

Example in the picture: top and bottom heating  at 190 °C.

1. Select the type of heating using the function control knob.

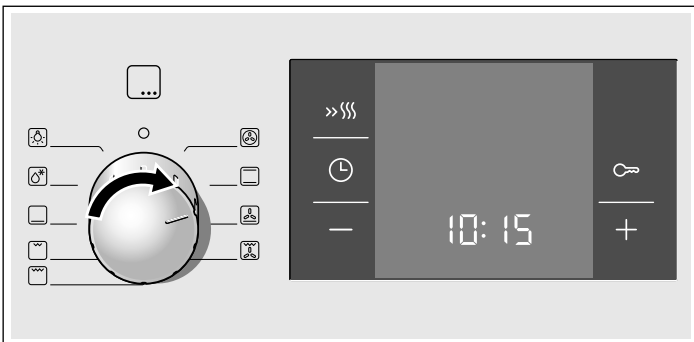

2. Select the temperature or grill power level with the temperature control knob.

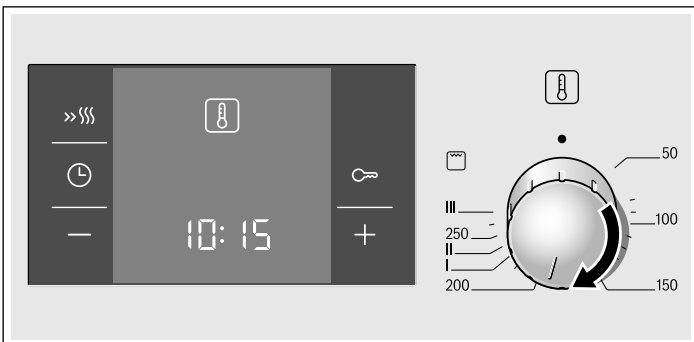

The oven will begin to heat up.

Switching off the oven

Turn the function selector to the off position.





Changing the settings

The type of heating and temperature or grill setting can be changed at any time using their respective selectors.

Rapid heating

With the rapid heating function, the oven reaches the programmed temperature very quickly.

Rapid heating must be used for temperatures of more than 100 °C. The following types of heating are appropriate:

- 3D Hot air 
- Top and bottom heating 
- Pizza function 
- Bottom heating 

To ensure uniform cooking, the food must not be put into the oven until rapid heating has been completed.

1. Select the temperature and type of heating required.
2. Briefly press the >>>> button.

The >>>> symbol lights up on the display panel. The oven will begin to heat up.

End of rapid heating

A beep will sound. The >>>> symbol disappears from the display panel. Put the food in the oven.

Cancelling rapid heating

Press the >>>> button. The >>>> symbol disappears from the display panel.

Setting the time functions

This oven has various time functions. The  sensor activates the menu and moves through the different functions. The time symbols remain lit up while settings are programmed. The square brackets [] indicate the time function selected. You can modify an already programmed time function directly with the sensors + or -, provided the time symbol is situated between square brackets [].

Timer

The timer works independently of the oven. The timer has its own beep. This can be used to distinguish whether the time set for the timer or the automatic oven shut-off have finished (cooking time).

1. Press the button once .

The time symbols light up on the display panel, the square brackets are next to .

2. Set the timer using the + or - buttons.

Value suggested for the + button = 10 minutes.

Value suggested for the - button = 5 minutes.

The programmed time is shown after a few seconds. The time set for the timer starts to count down. The symbol  lights up on the display panel and the timer's progress is shown. The other time symbols switch off.

The time set for the timer has elapsed

A beep will sound. The display panel will show **00:00**. Switch off the timer using the  button.

Changing the time on the timer.





Change the time set for the timer using the + or - buttons. The new time is shown after a few seconds.

Cancelling the timer

Resetting the timer to **00:00** with the button -. The new time is shown after a few seconds. The timer switches off.

Viewing the time settings

If several time functions are programmed, the corresponding symbols light up on the display panel. The symbol for the time function in the foreground is in brackets.

To view the timer , the cooking time , the end time  or the actual time , press the  sensor repeatedly until the brackets are around the required symbol. The corresponding value will be shown for a few seconds on the display panel.

Cooking time

The oven allows you to set the cooking time for each type of food. The oven switches off automatically when the cooking time has finished. This avoids interrupting other tasks to switch the oven off or exceeding the cooking time by mistake.

Example in the picture: cooking time: 45 minutes.

1. Select the type of heating using the function control knob.
2. Select the temperature or grill power level with the temperature control knob.

3. Press the  button twice.

The display panel will show **00:00**. The time symbols light up, the brackets are located next to .

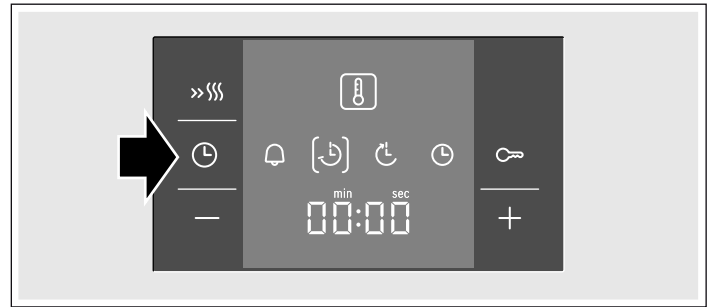

4. Set the cooking time with the + or - buttons.



Value suggested for the + button = 30 minutes.

Value suggested for the - button = 10 minutes.



The oven will switch on after a few seconds. The display panel shows the cooking time elapsed and the  symbol is displayed. The other time symbols switch off.

The cooking time has finished

A beep will sound. The oven will stop heating. The display panel will show **00:00**. Press the  button. Programme a new cooking time with the + or - buttons. Or press the  button twice and turn the function control knob to the zero setting. The oven is off.

Changing the cooking time





Change the cooking time with the + or - buttons. The new time is shown after a few seconds. If the timer has been programmed, first press the  button.

Cancelling the cooking time

Reset the cooking time to **00:00** with the button -. The new time is shown after a few seconds. The time has been cancelled. If the timer has been programmed, first press the  button.

Viewing the time settings

If several time functions are programmed, the corresponding symbols light up on the display panel. The symbol for the time function in the foreground is in brackets.



To view the timer , the cooking time , the end time  or the actual time , press the  sensor repeatedly until the brackets are around the required symbol. The corresponding value will be shown for a few seconds on the display panel.

End time

The oven allows you to set the time when you want the food ready. The oven switches on automatically and switches off at the set time. E.g. the food may be placed in the oven in the morning and the oven set so that it is ready at midday.

Please ensure that the food will not go off if it is in the oven for too long.

Example in the picture: It is now 10:30 AM, the cooking time is 45 minutes and the oven should switch off at 12:30 PM.



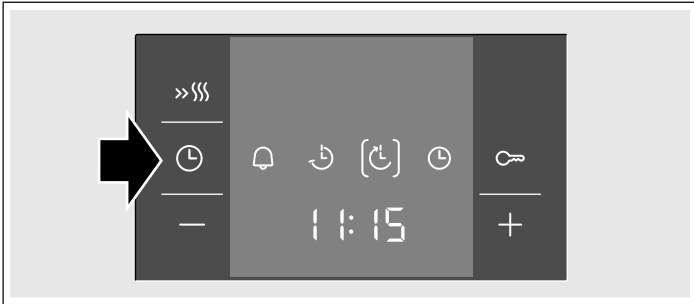

1. Set the function control knob.
2. Set the temperature control knob.
3. Press the  button twice.
4. Set the cooking time with the **+** or **-** buttons.
5. Press the  button.

The brackets are shown next to . The time the dish will be ready is displayed.



6. Delay the end time using the buttons **+** or **-**.



The oven displays the programmed time after a few seconds and is set to standby. The time when the dish will be ready is displayed and the end time  symbol will be shown in brackets. The symbols  and  turn off. When the oven is turned on, cooking time progress is shown and the symbol  appears in brackets. The symbol  is turned off.



Childproof lock

The oven includes a childproof lock to prevent it being turned on accidentally.

The oven does not react to any setting. The timer and time can be programmed when the childproof lock is on.

When the heating type and temperature or grill level are programmed, the childproof lock turns off the heating.

The cooking time has finished

A beep will sound. The oven will stop heating. The display panel will show **00:00**. Press the  button. Programme a new cooking time with the **+** or **-** buttons. Or press the  button twice and turn the function control knob to the zero setting. The oven is off.

Changing the end time





Change the end time using the buttons **+** or **-**. The new time is shown after a few seconds. If the timer has been programmed, first press the  button twice. Do not change the end time if the cooking time has already started to count down. The final result may not be the same.

Cancelling the end time

Reset the end time to the current time by pressing **-**. The new time is shown after a few seconds. The oven switches on. If the timer has been programmed, first press the  button twice.

Viewing the time settings

If several time functions are programmed, the corresponding symbols light up on the display panel. The symbol for the time function in the foreground is in brackets.

To view the timer , the cooking time , the end time  or the actual time , press the  sensor repeatedly until the brackets are around the required symbol. The corresponding value will be shown for a few seconds on the display panel.

Time

Once the oven has been connected or after a power cut, a flashing  symbol and four zeros are shown on the display panel. Set the time.



1. Press the  button.
The display panel displays the time **12:00**.

2. Set the time with the buttons **+** or **-**.

The programmed time is displayed after a few seconds.

Changing the time

No other time function can be programmed.

1. Press the  button four times.
The time symbols light up on the display panel, the brackets are located next to .
2. Adjust the time with the buttons **+** or **-**.

The programmed time is displayed after a few seconds.

Hiding the clock

You can hide the clock. For more information, please refer to the section *Changing the basic settings*.

Activating the childproof lock

No cooking time or end time should already be set.

Press the  button for approximately four seconds.

The display panel shows the symbol . The childproof lock is now activated.

Turning off the childproof lock

Press the  button for approximately four seconds.

The  symbol in the display panel goes off. The childproof lock is now deactivated.

Changing the basic settings

This oven has different basic settings. The settings can be adapted to the user's own needs.

Basic settings	Selection 1	Selection 2	Selection 3
Time indicator	always*	only with the button	-
Duration of signal after the cooking time or the time set on the timer has elapsed	approx. 10 sec	approx. 2 min.*	approx. 5 min
Time until a setting is applied	approx. 2 sec	approx. 5 sec.*	approx. 10 sec.

* Default setting

No other time function can be programmed.

- Press the button for approximately 4 seconds. The display panel will show the current basic setting for the time, e.g. for the Selection 1.
- Set the basic setting using the buttons **+** or **-**.
- Confirm with the button. The display panel shows the following basic setting. Using the button select the levels and using the buttons **+** or **-** make the setting.
- Press the button for approximately 4 seconds. All basic settings have been applied.

The basic settings can be changed again at any time.

Care and cleaning

If cleaned and properly cared for, your oven will keep its bright appearance and operating performance for many years to come. Advice on how to care for and clean your oven is provided below.

Notes

- Different colours may be seen in your front panel due to the various materials used in its manufacture, such as glass, plastic and metal.
- Dark patches in the door's glass panel may seem to be dirt but they are in fact reflections from the oven light.
- Enamel burns at very high temperatures. This may cause slight discolouration. This is normal and does not affect the oven's operation. The edges of thin baking trays may not be completely enamelled. They may therefore feel slightly rough, although their corrosive protection will be unaffected.

Cleaning products

Follow the indications provided in the table to avoid damaging the various oven surfaces by using unsuitable cleaning products. Do not use

- abrasive or acidic cleaning products
- strong products containing alcohol
- scourers or hard sponges
- high-pressure or steam cleaners

Wash new dishcloths thoroughly before use.

Zone	Cleaning products
Front panel	Hot water and a little soap: Clean with a dishcloth and dry with a soft cloth. Do not use a glass cleaning product or a glass scraper.
Stainless steel	Hot water and a little soap: Clean with a dishcloth and dry with a soft cloth. Immediately remove any water marks, grease, cornflower or egg white stains since corrosion could occur underneath these marks or stains. Special products for the care of stainless steel and which are suitable for hot surfaces may be obtained from Technical Assistance Service centres and specialist retail outlets. Use a very fine soft cloth to apply the cleaning product.

Zone	Cleaning products
Glass panel	Glass cleaning products: Clean using a soft cloth. Do not use a glass scraper.
Display	Glass cleaning products: Clean using a soft cloth. Do not use alcohol, vinegar or other abrasive or acidic cleaning products.
Glass panels on oven door	Glass cleaning products: Clean using a soft cloth. Do not use a glass scraper.
Glass cover for the oven light	Hot water and a little soap: Clean with a dishcloth.
The seal Do not remove!	Hot water and a little soap: Clean with a dishcloth. Do not rub.
Wire shelves or rails	Hot water and a little soap: Soak and clean using a dishcloth or brush.
Sliding guides	Hot water and a little soap: Clean with a dishcloth or a brush. Do not leave this to soak or wash in a dishwasher.
Accessories	Hot water and a little soap: Soak and clean using a dishcloth or brush.

Cleaning the self-cleaning surfaces in the oven interior

The inside rear and side walls and top of some ovens may be lined with a highly porous ceramic lining. This lining absorbs splashes produced during baking and roasting, dissolving them while the oven is working. This cleaning will be most effective at higher temperatures and during longer cooking times.

Proceed as follows if the oven is still dirty after being used several times:

- Thoroughly clean the bottom and any walls that do not have this lining.
- Programming the 3D Hot air function.
- Empty the oven and then leave it on with the door closed for approximately 2 hours at maximum temperature.

The ceramic lining will regenerate. Once the oven has cooled down, remove any brown and white stains with water and a soft sponge.

Slight discolouration of the lining does not affect its self-cleaning performance.

Caution!

- Do not use abrasive cleaning products. These would scratch and impair the highly porous lining.
- Never use oven cleaning products on ceramics. If oven cleaner is spilled on this accidentally, immediately remove it using lots of water and a sponge.

Cleaning the oven's enamelled bottom and walls

Use a cleaning cloth and hot water with a little soap or vinegar. If very dirty, use a fine steel scourer or a special oven cleaning product. These must only be used when the oven interior is cold. Do not use metal scourers or special oven cleaning products on self-cleaning surfaces.

Light

The oven light can be turned on manually to facilitate cleaning.

Turning on the oven light

Turn the function control knob to the  position.

The light will come on. The temperature control knob must be turned off.

Turning the oven light off

Turn the function control knob to the 0 position.

Removing the grill heating element

The grill heating element can be removed in some ovens to facilitate cleaning.

Risk of burns.!

The oven must be cold.

1. Pull the grill element handle towards you and push it upwards until you hear it click into position (figure A).
2. At the same time, hold the grill element and swing it down (figure B).

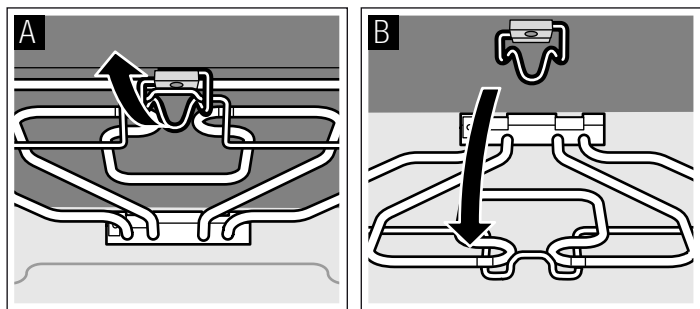

After cleaning, push the grill heating element up again. Push the locking handle down and secure the grill element.

Removing and refitting the wire shelves or left and right hand side rails

The wire shelves or left and right hand side rails can be removed for cleaning. The oven must be cold.

Release the guides or rails

1. Lift the front of the guide or rail and release it (figure A).
2. Then pull the guide or rail forwards completely and remove it (figure B).

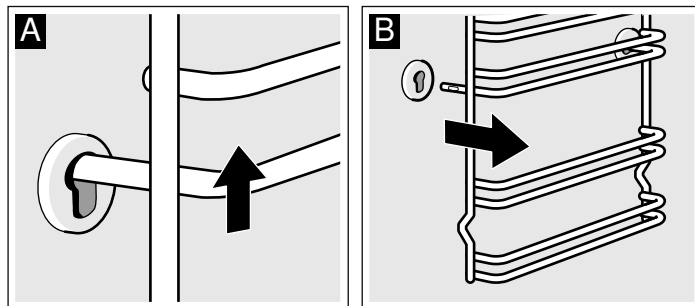

Clean the guides or rails with detergents and a sponge. The use of a brush is recommended for stubborn stains.

Install the wire shelves or rails

1. First insert the shelf or the rail in the rear groove by pushing it back slightly (figure A)
2. then insert it in the front groove (figure B).

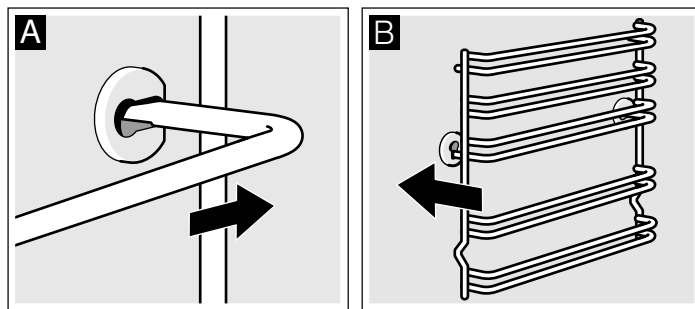

Wire shelves or rails can be adjusted on the left and right hand side. Their curvature should always be face down.

Unhooking and hanging the oven door

The front panel can be unhooked to help remove the oven door and clean the glass panels.

The oven door hinges are fitted with a locking lever. The door cannot be unhooked if the locking lever is closed (figure A). Once the locking lever has been opened to unhook the door (figure B), the hinges will be locked in position. This prevents the door from suddenly closing.

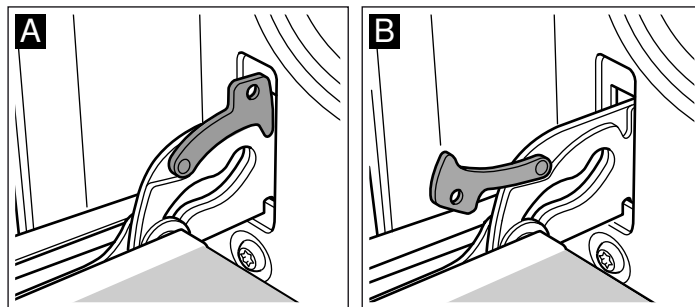

Risk of injuries.!

The hinges may close suddenly if they are not locked in position by the lever. Note that the locking levers are always closed, apart from when unhooking the door, when the levers must be open.

Unhooking the door

1. Fully open the oven door.
2. Remove both locking levers located on the right and left hand sides (figure A).
3. Fully close the oven door as far as possible (figure B). Grip the left and right hand sides of the door with both hands. Close the door slightly more and remove it.

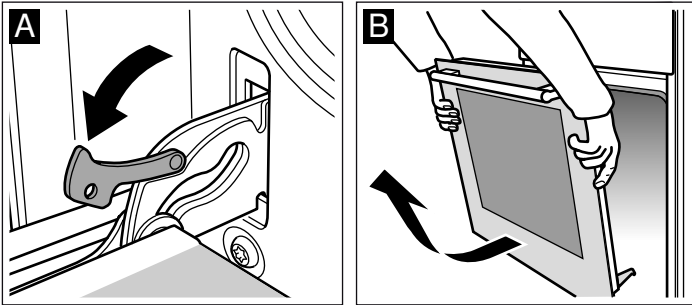

Hanging the door

Rehang the door by following the same steps but in reverse order.

1. When refitting the door, check that both hinges are positioned exactly inside their respective openings (picture A).
2. The bottom groove of the hinges must fit snugly on both sides.

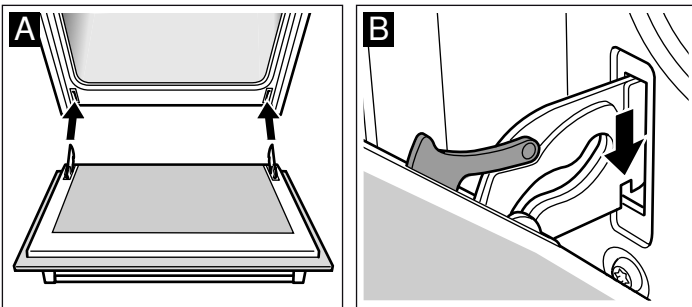

The door may be left crooked if the hinges are not mounted properly.

3. Reclose the attachment levers (picture C). Close the oven door.

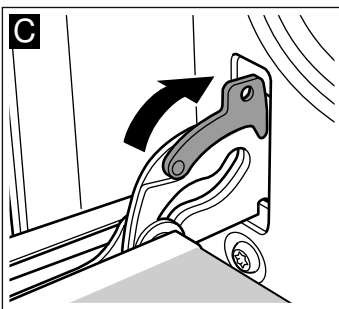

⚠ Risk of injuries.!

Do not touch the hinges; the door might accidentally fall or a hinge might suddenly close. Notify the Technical Assistance Service.

Removing and installing the door panels

To facilitate cleaning, you can remove the glass panels from the oven door.

Dismantling

1. Unhook the oven door and place it on a cloth with its handle pointing downwards.
2. Remove the upper cover from the oven door. To do this, press with your fingers on the tabs on the left and right (Figure A).
3. Lift and remove the top glass panel (Figure B).

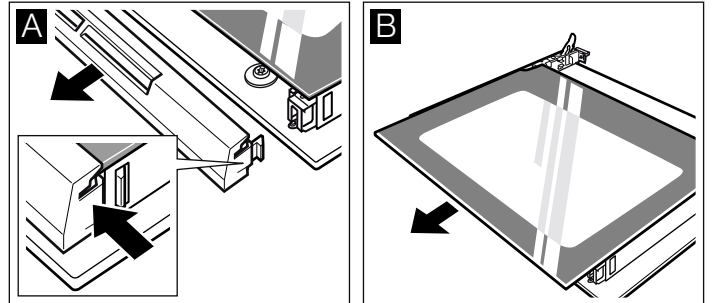

In doors with three glass panels, the following step will also be necessary:

4. Lift and remove the glass panel (Figure C).

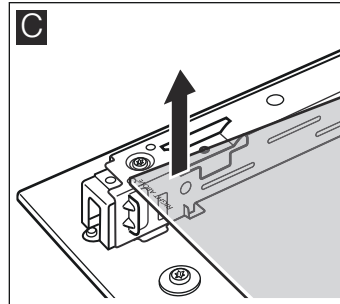

Clean the glass panels using a glass cleaning product and a soft cloth.

Do not use abrasive or corrosive cleaning products, glass scrapers or hard metal scourers as these could damage the glass.

⚠ Risk of injury!

Scratched glass in the appliance door may develop into a crack. Do not use a glass scraper, or sharp or abrasive cleaning aids or detergents.

Installing

Follow steps 2 to 4 with doors that have two glass panels.

When installing, ensure that the "right above" inscription on the lower left part is inverted.

1. Insert the glass panel by tilting it backwards (Figure A).
2. Insert the upper glass panel on both mounts by tilting it backwards. Ensure that its smooth surface is facing outwards. (Figure B)

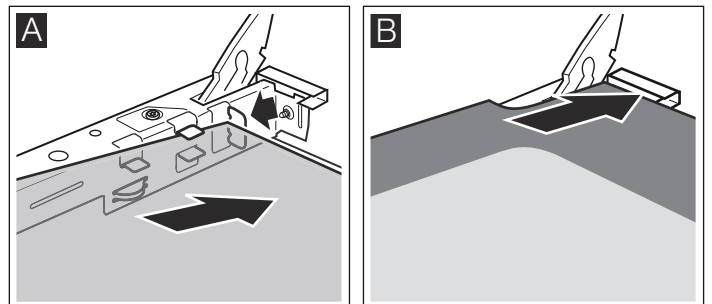

3. Fit and tighten the cover.

4. Refit the oven door.

Once the glass panels have been correctly fitted, the oven is ready to use.

Troubleshooting

Quite often, when there is a malfunction, it is usually a small irregularity which is easy to rectify. Before contacting the Technical Assistance Service, try to determine the cause of the fault using the following table.

Troubleshooting table

Fault	Possible cause	Solution/advice
The oven does not work.	The fuse has blown.	Check the state of the fuse in the fuse box.
	Power cut.	Check that the light in the kitchen and other household appliances are working.
The display panel shows a flashing ⊕ symbol and four zeros.	Power cut.	Set the time once again.
The oven does not heat up.	There is dust on the contacts.	Turn the control knobs several times in both directions.

Error messages

When the display panel shows an error message with **E**, press the ⊕ button. The message will disappear. The set time function will be deleted. If the error message does not disappear, call the Technical Assistance Service.

The following error messages can be solved by the user.

Error message	Possible cause	Solution/advice
E011	A button has been pressed for too long or has got stuck.	Press all of the buttons one by one. Check if any button is stuck, covered or dirty.

⚠ Risk of electric shock.!

Incorrect repairs can be dangerous. Repairs may only be carried out by qualified personnel from the Technical Assistance Service.

Changing the oven bulb

If the oven light bulb is damaged it must be replaced. Special 25 W, E14, 220 V-240 V heat-resistant light bulbs (to 300 °C temperature) can be obtained from the Technical Support Service or in specialist shops. Only use this type of bulb.

⚠ Risk of electrical discharge and the resulting shock.!

Disconnect the appliance from the mains. Ensure that this is turned off.

1. Place a dishcloth into the cold oven to avoid damage.
2. Remove the glass protection by unscrewing it to the left.

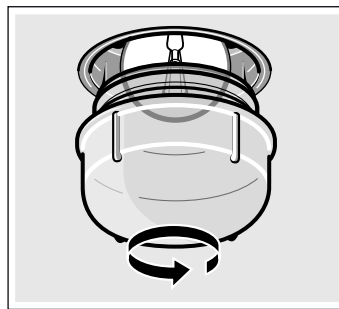

3. Replace the bulb with a similar bulb.
4. Screw the protection glass back into place.
5. Remove the dishcloth and switch the oven back on at the mains.

Protective glass panels

Damaged protective glass panels must be replaced. Protective glass panels can be obtained from the Technical Assistance Service. Please quote your appliance's product number and production number.

After-sales service

Our after-sales service is there for you if your appliance needs to be repaired. We will always find the right solution in order to avoid unnecessary visits from a service technician.

E number and FD number

When calling us, please give the product number (E no.) and the production number (FD no.) so that we can provide you with the correct advice. The rating plate containing these numbers can be found on the right-hand side of the oven door. You can make a note of the numbers of your appliance and the telephone number of the after-sales service in the space below to save time should it be required.

E no.	FD no.
-------	--------

After-sales service

Please note that there will be a fee for a visit by a service technician in the event of a malfunction, even during the warranty period.

Please find the contact data of all countries in the enclosed customer service list.

To book an engineer visit and product advice

GB 0844 8928979

Calls from a BT landline will be charged at up to 3 pence per minute. A call set-up fee of up to 6 pence may apply.

IE 01450 2655

Trust the expertise of the manufacturer, and rest assured that the repair will be carried out by trained service technicians using original spare parts for your domestic appliance.

Energy and environment tips

Here you can find tips on how to save energy when baking and roasting and how to dispose of your appliance properly.

Saving energy

- Preheat the oven only if this is required by a recipe or is indicated in the tables.
- Use dark, lacquered or black enamel baking tins. These are more efficient at absorbing heat.
- Keep the oven door closed during cooking, baking and roasting cycles.
- When baking several cakes, these should be preferably baked one after the other. The oven will still be hot, thereby reducing the cooking time for the second cake. Two rectangular baking tins can be placed side-by-side.

- For long cooking times, the oven may be turned off 10 minutes prior to the specified time, allowing the item to continue to cook but taking advantage of the oven's residual heat.

Environmentally-friendly disposal of waste

Dispose of packaging with the environment in mind.



This appliance is identified according to the Waste Electrical and Electronic Equipment Directive WEEE 2002/96/EC. This directive defines the framework for the recycling and reuse of appliances used in EU territory.

Tested for you in our cooking studio

Here you will find a selection of dishes and the ideal settings for them. We will show you which type of heating and which temperature are best suited for your dish. You can find information about suitable accessories and the height at which they should be inserted. There are also tips about cookware and preparation methods.

Notes

- The values in the table always apply to dishes placed into the cooking compartment when it is cold and empty.
Only preheat the appliance if the table specifies that you should do so. Do not line the accessories with greaseproof paper until after they have been preheated.
- The times specified in the tables are guidelines only. They will depend on the quality and composition of the food.
- Use the accessories supplied. Additional accessories may be obtained as special accessories from specialist retailers or from the after-sales service.
Before using the oven, remove any unnecessary accessories and ovenware from the cooking compartment.
- Always use oven gloves when taking hot accessories or ovenware out of the cooking compartment.

Cakes and pastries

Baking on one level

The best method for baking a cake is to place it on one level with top and bottom heating .

When baking using the 3D  Hot air function, the following levels are recommended for the accessories:

- Cakes in tins: level 2
- Cakes on the tray: level 3

Baking at different levels

Use the 3D  Hot air mode.

Baking on two levels:

- Universal tray: level 3.
- Oven tray: level 1.

Baking on three levels:

- Universal tray: level 5.
- Oven tray: level 3.
- Oven tray: level 1.

Trays put in the oven at the same time are not necessarily ready at the same time.

In these tables you will find numerous tips for your dishes.

If 3 rectangular cake tins are used at the same time, place on the wire shelf as shown in the diagram.

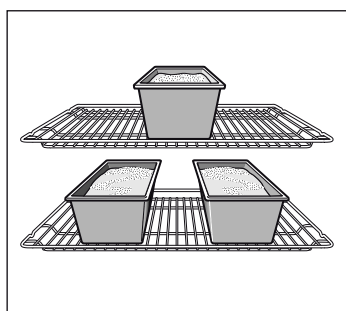

Baking tins

It is best to use dark-coloured metal baking tins.

Baking times are increased when light-coloured baking tins made of thin metal or glass dishes are used, and cakes do not brown so evenly.

If you wish to use silicone baking tins, use the information and recipes provided by the manufacturer as a guide. Silicone baking tins are often smaller than normal tins. The amount of mixture and recipe instructions may differ.

Tables

The table shows the optimum heating methods for each type of cake or dessert. The temperature and cooking time will depend on the amount and the consistency of the dough. For this reason the cooking tables always provide approximate cooking times. Always begin by trying the lowest value. The items will be more evenly browned at a lower temperature. If necessary, this can be increased next time.

If the oven is preheated, cooking times are reduced by 5 to 10 minutes.

Additional information is provided in the Tips for baking section as an appendix to the tables.





To bake a cake only on one level, place the mould on the enamel tray.



















When baking several cakes at the same time, the moulds can be placed together on the wire shelf.

Cakes in tins	Cake tin	Level	Heating type	Temperature in °C	Time in minutes
Easy sponge cake	Crown-shaped/rectangular cake tin	2	☉	160-180	60-75
	3 rectangular cake tins	3+1	☉	140-160	70-90
Batter dough cakes, fine	Crown-shaped/rectangular cake tin	2	☐	150-170	60-70
Tart base, sponge cake dough	Tart tin	3	☐	160-180	20-30
Fine fruitcake, sponge cake dough	Round/springform tin	2	☐	160-180	50-60
Sponge cake base, 2 eggs (preheat)	Tart tin	2	☐	150-170	20-30
Sponge cake base, 6 eggs (preheat)	Springform tin	2	☐	150-170	40-50
Shortcrust pastry base with edge	Springform tin	1	☐	180-200	25-35
Cheese cake or fruit tart, shortcrust pastry base*	Springform tin	1	☐	160-180	70-90
Quiche	Pizza tray	1	☐	220-240	35-45
Sponge in concentric cake tin	Concentric cake tin	2	☐	150-170	60-70
Pizza, thin base with light topping (preheat)	Pizza tray	1	☐	270	10-20
Savoury cake*	Springform tin	1	☐	170-190	45-55

* Let the cake cool for 20 minutes with the oven switched off and closed.

Cakes prepared on the tray	Accessories	Level	Heating type	Temperature in °C	Time in minutes
Dry layer sponge cake	Universal tray	2	☐	170-190	20-30
	Universal tray + oven tray	3+1	☉	160-170	30-40
Fruit or liquid layer sponge cake	Universal tray	2	☐	170-190	25-35
	Universal tray + oven tray	3+1	☉	140-160	40-50
Dry layer yeast dough	Universal tray	3	☐	170-180	25-35
	Universal tray + oven tray	3+1	☉	150-170	35-45
Fruit or liquid layer yeast dough	Universal tray	3	☐	160-180	40-50
	Universal tray + oven tray	3+1	☉	150-160	50-60
Lattice-topped shortcrust tart with dry layer	Universal tray	1	☐	180-200	20-30
Lattice-topped shortcrust tart with fruit or liquid layer	Universal tray	2	☐	160-180	60-70
Quiche	Universal tray	1	☐	210-230	40-50
Swiss roll (preheating)	Universal tray	2	☐	170-190	15-20
Plaited loaf made with 500 g of flour	Universal tray	2	☐	170-190	25-35
Bread roll made with 500 g of flour	Universal tray	3	☐	160-180	60-70
Bread roll made with 1 kg of flour	Universal tray	3	☐	150-170	90-100







Cakes prepared on the tray	Accessories	Level	Heating type	Temperature in °C	Time in minutes
Puff pastry, sweet	Universal tray	2		190-210	55-65
Pizza	Universal tray	2		200-220	25-35
	Universal tray + oven tray	3+1		180-200	40-50
Flambéed tart (preheating)	Universal tray	2		270	15-20
Börek	Universal tray	2		190-200	40-55

Small pastries	Accessories	Level	Heating type	Temperature in °C	Time in minutes
Pastries and biscuits	Universal tray	3		140-160	15-25
	Universal tray + oven tray	3+1		130-150	25-35
	2 oven trays + universal tray	5+3+1		130-150	25-40
Tea biscuits (preheating)	Universal tray	3		140-150	30-40
	Universal tray	3		140-150	20-30
	Universal tray + oven tray	3+1		140-150	25-35
	2 oven trays + universal tray	5+3+1		140-150	25-35
Macaroons	Universal tray	2		110-130	30-40
	Universal tray + oven tray	3+1		110-120	35-45
	2 oven trays + universal tray	5+3+1		110-120	35-45
Meringues	Universal tray	3		80-100	100-150
Tartlets	Wire shelf and tartlet tin	3		180-200	20-25
	2 wire shelves and tartlet tin	3+1		160-180	25-30
Ensaïmada	Universal tray	2		210-230	30-40
Puff pastry	Universal tray	3		190-200	25-35
	Universal tray + oven tray	3+1		190-200	30-40
	2 oven trays + universal tray	5+3+1		170-180	35-45
Yeast dough pastry	Universal tray	2		190-210	20-30
	Universal tray + oven tray	3+1		160-180	25-35

Bread and rolls



Preheat the oven for bread making unless otherwise instructed.

Do not spill water directly into the oven when it is hot.

Bread and rolls	Accessories	Level	Heating	Temperature in °C	Time in minutes
Yeast bread made using 1.2 kg of flour	Universal tray	2		270	8
				200	35-45
Fermented dough bread made using 1.2 kg of flour	Universal tray	2		270	8
				200	40-50
Bread pudding	Universal tray	2		270	15-20
Bread rolls (no preheating)	Universal tray	3		200	20-30
Sweet yeast dough bread rolls	Universal tray	3		180-200	15-20
	Universal tray + oven tray	3+1		150-170	20-30

Suggestions and practical advice for baking

If you want to use your own recipe.	You can use a similar product to the one listed in the cooking table as a guide.
How to check whether your sponge cake is ready.	10 minutes before the end of the cooking time indicated in the recipe, test the thickest part of the cake with a thin wooden skewer. The cake is ready when the skewer comes out clean, with no traces of cake mix.
The cake is too flat.	Next time, try using less liquid or reduce the oven temperature by 10 degrees. Ensure you mix the dough according to the times given in the recipe.
The cake has a peaked centre, but the edges are lower.	Do not grease the cake tin. Once the cake is ready, use a knife to carefully remove it from the cake tin.
If the cake is too brown on top.	Position the cake lower in the oven, reduce the oven temperature and bake it for longer.

The cake is too dry.	Use a skewer to make small holes in the finished cake. Pour a few drops of fruit juice or alcoholic drink over the cake. Next time, increase the oven temperature by 10 degrees and reduce the cooking time.
The bread or cake (fruit cake, for example) looks fine on the outside but still has soft (soggy) areas inside.	Next time, use less liquid and leave the product for a little longer in the oven, at a lower temperature. The bases of cakes with juicy toppings should be baked first on their own. Then sprinkle chopped almonds or breadcrumbs on the base before adding the topping. Follow the recipe and the cooking times.
Pastries are not evenly browned.	Select a lower temperature; the pastries will be browned more uniformly. Bake more delicate pastries with top and bottom heating  on one level. Overhanging greaseproof paper may also affect air circulation. Always trim it to fit the baking tray.
The fruit pie is not brown enough at the bottom.	Next time put the pie in at a lower level.
The fruit juices are spilling out.	Next time use the universal tray if available.
Small pastries made with yeast may stick together during baking.	Leave a space of about 2 cm between them. Then they will have enough space to rise and brown on all sides.
Products have been baked on different levels. Pastries on the upper tray are darker than those on the lower tray.	Always use the 3D  Hot air function when baking products on different levels. Although several baking trays may be placed in the oven at the same time, this does not mean that they will necessarily all be ready at the same time.
Baking moist cakes produces condensation.	Condensation may form when baking. Some of this moisture may evaporate via the door handle, and drops of condensation may form on the control panel or on the front of nearby kitchen units. The oven is physically designed with this in mind.

Meat, poultry, fish

Cookware

Any heatproof cookware can be used. For large roasts, the enamel tray can also be used.

It is best to use glass containers. Check that the lid of the cookware will fit and close properly.

If using enamel containers, add more liquid.

When using stainless steel pans, the meat does not brown well and may even be left rare. If so, lengthen the cooking time.

Data shown in tables:

Uncovered cookware = open

Covered cookware = closed

Always place cookware in the centre of the wire shelf.

Hot glass cookware should be placed on a dry dishcloth. The glass could shatter if rested on a wet or cold surface.

Roasting

Add in a little liquid if the meat is lean. Cover the base of the ovenware with approx. ½ cm of liquid.

Add liquid generously for pot roasts. Cover the base of the ovenware with approx. 1 - 2 cm of liquid.

The amount of liquid depends on the type of meat and the material the ovenware is made of. If preparing meat in an enamelled roasting dish, it will need a little more liquid than if cooked in glass ovenware.

Roasting dishes made from stainless steel are not ideal. The meat cooks more slowly and browns less fully. Use a higher temperature and/or a longer cooking time.

Grilling

Always use the grill with the oven closed.

For grilling, preheat the oven for about 3 minutes before the food is placed inside the oven.

Place the pieces directly on the wire shelf. If only one piece is prepared, it is best if placed in the centre of the wire shelf.

Place the enamel tray at level 1. The tray will help keep the oven clean by catching any meat juices.

Do not place the baking tray or universal tray at level 4 or 5. Due to the extreme heat, it could be deformed and cause damage to the oven interior when it is removed.

In so far as it is possible, use pieces of the same thickness. This will help them brown evenly and remain juicy. Salt the fillets after grilling.

Turn the pieces after ⅔ the time has elapsed.

The grill resistance switches on and off automatically. This is normal. The frequency depends on the chosen power level.







Meat

Turn pieces of meat halfway through the cooking time.

When the roast is ready, turn off the oven and allow it to rest for an additional 10 minutes. This allows better distribution of the meat juices.

After cooking, wrap sirloin in aluminium foil and leave it to rest for 10 minutes in the oven.

For roast pork with a rind, score the rind in a crossways pattern, then lay the roast in the dish with the rind at the bottom.

Meat	Weight	Accessories and cookware	Level	Heating	Temperature at °C, grill power	Time in minutes
Beef	Braised beef	covered	1.0 kg	2	 200-220	100
	1.5 kg		2	 190-210	120	
	2.0 kg		2	 180-200	140	
Steak, medium rare	1.0 kg	uncovered	2	 210-230	60	
	1.5 kg		2	 200-220	80	
Roast beef, medium rare	1.0 kg	uncovered	1	 220-240	60	
Beefsteak, 3 cm thick, medium rare		Wire shelf + universal tray	5+1	 3	15	

Meat	Weight	Accessories and cook-ware	Level	Heating	Temperature at °C, grill power	Time in minutes
Veal						
Roast veal	1.0 kg	uncovered	2		190-210	110
	1.5 kg		2		180-200	130
	2.0 kg		2		170-190	150
Leg of veal	1.5 kg	uncovered	2		210-230	140
Pork						
Roast without bacon (e. g. nape)	1.0 kg	uncovered	1		190-210	120
	1.5 kg		1		180-200	150
	2.0 kg		1		170-190	170
Roast with bacon (e. g. shoulder)	1.0 kg	uncovered	1		190-210	130
	1.5 kg		1		180-200	160
	2.0 kg		1		170-190	190
Pork loin	500 g	Wire shelf + universal tray	3+1		230-240	30
Roast pork, lean	1.0 kg	uncovered	2		190-210	120
	1.5 kg		2		180-200	140
	2.0 kg		2		170-190	160
Shoulder of pork with bone	1.0 kg	covered	2		210-230	70
Beefsteak, 2 cm thick		Wire shelf + universal tray	5+1		3	15
Pork medallions, 3 cm thick		Wire shelf + universal tray	5+1		3	10
Lamb						
Shoulder of lamb with bone	1.5 kg	uncovered	2		190-210	60
Leg of lamb, no bone, medium rare	1.5 kg	uncovered	1		160-180	120
Game						
Fillet of venison on the bone	1.5 kg	uncovered	2		200-220	50
Boneless leg of venison	1.5 kg	covered	2		210-230	100
Roast boar	1.5 kg	covered	2		180-200	140
Roast venison	1.5 kg	covered	2		180-200	130
Rabbit	2.0 kg	covered	2		220-240	60
Minced meat						
Minced meat casserole	500 g of meat	uncovered	1		180-200	80
Sausages						
Sausages		Wire shelf + universal tray	4+1		3	15

Poultry

The weights of the table are for unstuffed birds ready to roast.

Place whole birds on the wire shelf initially with the breast side down. Turn once after $\frac{2}{3}$ the estimated time.









Turn pieces of meat such as turkey pieces or turkey breasts over after half the cooking time has elapsed. Turn the pieces of poultry after $\frac{2}{3}$ the time has elapsed.

If cooking duck or goose, prick the skin below the wings to release the fat.

The birds can be made brown and crunchy if they are smeared with butter, brine or orange juice more or less at the end of cooking time.

If grilling directly on the shelf, place the enamel tray on level 1.

Poultry	Weight	Accessories and cookware	Level	Heating	Temperature at °C, grill power	Time in minutes
Chicken, whole	1.2 kg	Wire shelf	2		220-240	60-70
Poularde, whole	1.6 kg	Wire shelf	2		210-230	80-90
Chicken, halves	500 g each	Wire shelf	2		220-240	40-50
Chicken pieces	150 g each	Wire shelf	3		210-230	30-40
Chicken pieces	300 g each	Wire shelf	3		210-230	35-45
Chicken breasts	200 g each	Wire shelf	3		3	30-40

Poultry	Weight	Accessories and cookware	Level	Heating	Temperature at °C, grill power	Time in minutes
Duck, whole	2.0 kg	Wire shelf	2		190-210	100-110
Duck breasts	300 g each	Wire shelf	3		240-260	30-40
Goose, whole	3.5-4.0 kg	Wire shelf	2		170-190	120-140
Goose legs	400 g each	Wire shelf	3		220-240	40-50
Small turkey, whole	3.0 kg	Wire shelf	2		180-200	80-100
Turkey roll	1.5 kg	uncovered	1		200-220	110-130
Turkey breast	1.0 kg	covered	2		180-200	90
Turkey thigh	1.0 kg	Wire shelf	2		180-200	90-100

Fish







Turn the fish pieces after $\frac{2}{3}$ the time has elapsed.

Whole fish do not need to be turned over. Bake whole fish in swimming position with the dorsal fin up. So that the fish

remains stable, place a cut potato or a small container suitable for baking into the abdomen of the fish.

To cook fish fillets, add a few tablespoons of liquid when cooking.

If grilling directly on the shelf, place the enamel tray on level 1.

Fish	Weight	Accessories and cookware	Level	Heating	Temperature at °C, grill power	Time in minutes
Fish, whole	of approx. 300 g	Wire shelf	2		2	20-25
	1.0 kg	Wire shelf	2		200-220	45-55
	1.5 kg	Wire shelf	2		190-210	60-70
	2.0 kg	covered	2		190-210	70-80
Ventresca fish, 3 cm thick		Wire shelf	3		2	20-25
Fish fillet		covered	2		210-230	25-30

Tips for roasting and grilling

The table does not contain information for the weight of the joint. Select the next lowest weight from the instructions and extend the time.

How to tell when the roast is ready. Use a meat thermometer (available from specialist shops) or carry out a "spoon test". Press down on the roast with a spoon. If it feels firm, it is ready. If the spoon can be pressed in, it needs to be cooked for a little longer.

The roast is too dark and the crackling is partly burnt. Check the shelf height and temperature.

The roast looks good but the juices are burnt. Next time, use a smaller roasting dish or add more liquid.

The roast looks good but the juices are too clear and watery. Next time, use a larger roasting dish and use less liquid.





Steam rises from the roast when basted. This is normal and due to the laws of physics. The majority of the steam escapes through the steam outlet. It may settle and form condensation on the cooler switch panel or on the fronts of adjacent units.





Au gratin, soufflés, toast

Place the cookware on the wire shelf.

To roast directly on the wire shelf without containers, insert the enamelled tray at level 1. This will keep the oven cleaner.

The result of a gratin depends on the size of the dish and gratin height. The data shown in the table are only given as a guide.

Food	Accessories and cookware	Level	Heating	Temperature at °C, grill power	Time in minutes
Gratins					
Gratins, dessert	Tin for au gratin cooking	2		180-200	50-60
Soufflé	Tin for au gratin cooking	2		180-200	35-45
	Ramekins	2		200-220	25-30
Pasta au gratin	Tin for au gratin cooking	2		200-220	40-50
Lasagne	Tin for au gratin cooking	2		180-200	40-50



















Food	Accessories and cookware	Level	Heating	Temperature at °C, grill power	Time in minutes
Au gratin dishes					
Potatoes gratin with raw ingredients, max. 4 cm in height	1 baking pan for au gratin cooking	2		160-180	60-80
	2 two baking pans for au gratin cooking	3+1		150-170	60-80
Toast					
4 units au gratin	Wire shelf + universal tray	3+1		160-170	10-15
12 units, au gratin	Wire shelf + universal tray	3+1		160-170	15-20

Ready-made products

Read the manufacturer's instructions on the packaging.

When covering accessories with parchment paper, ensure that the paper is suitable for high temperatures. Cut the paper to the size of the dish to be prepared.

The result depends directly on the type of food. There may be irregularities and colour differences in raw products.

Dish	Accessories	Level	Heating type	Temperature in °C	Time in minutes
Pizza, deep frozen					
Thin base pizza	Universal tray	2		200-220	15-25
	Universal tray + wire shelf	3+1		180-200	25-35
Thick base pizza	Universal tray	2		170-190	20-30
	Universal tray + wire shelf	3+1		170-190	30-40
Pizza-baguette	Universal tray	3		170-190	20-30
Mini pizza	Universal tray	3		190-210	10-20
Pizza, frozen					
Pizza (preheat)	Universal tray	1		180-200	10-15
Potato-based products, deep frozen					
Chips	Universal tray	3		190-210	20-30
	Universal tray + oven tray	3+1		190-200	35-45
Croquettes	Universal tray	3		190-210	20-25
Potato cakes, stuffed potatoes	Universal tray	3		200-220	15-25
Bakery products, deep frozen					
Bread rolls and baguettes	Universal tray	3		180-200	10-20
Pretzels (bread dough)	Universal tray	3		200-220	10-20
Bakery products, pre-baked					
Bread rolls and baguettes	Universal tray	2		190-210	10-20
	Universal tray + wire shelf	3+1		160-180	20-25
Fried foods, deep frozen					
Fish fingers	Universal tray	2		220-240	10-20
Chicken fingers, nuggets	Universal tray	3		200-220	15-25
Puff pastry, deep frozen					
Puff pastry	Universal tray	3		190-210	30-35

Special dishes

At low temperatures, a good creamy yoghurt and a spongy yeast dough can be obtained.

First remove accessories and wire shelves or left and right-hand side rails from inside the oven.



Making yoghurt

1. Boil 1 litre of milk (3.5 % fat) and allow it to cool to about 40 °C.
2. Mix 150 g of yoghurt (at fridge temperature).

3. Pour the mixture into jars or bowls and cover them with transparent film.
4. Preheat the oven as instructed.
5. Now, place the bowls or jars on the bottom of the oven and prepare as follows.

Leaving yeast dough to rise

1. Prepare the yeast dough as usual. Pour the dough into a heat-resistant ceramic baking dish and cover it.
2. Preheat the oven as instructed.
3. Turn off the appliance and allow the dough to rise inside the oven.

Food	Cookware	Level	Type of heating	Temperature	Time
Yoghurt	Place the bowls or jars	at the bottom of the oven		Preheat to 50 °C 50 °C	5 min. 8 h
Allow the dough with yeast to rise	Place a heat resistant cookware	at the bottom of the oven		Preheat to 50 °C turn off the appliance and place the dough inside the oven.	5-10 min. 20-30 min.

Defrosting

Defrosting time depends on the type and quantity of food.
Read and note the manufacturer's instructions on the packaging.





Remove frozen food from the container and place in appropriate cookware on the wire shelf.
Place the bird on a dish with the breast facing down.

Frozen products	Accessories	Level	Type of heating	Temperature
For example, cream cakes, buttercream tarts, chocolate or sugar-coated cakes, fruit, chicken, sausages and meat, bread, rolls, pies and other pastries	Shelf	1		The temperature control knob remains off.

Drying

Use only fruit and vegetables that are in perfect condition and wash them thoroughly first.
Drain well and dry thoroughly.

Place the universal tray on level 3 and the shelf on level 1.
Cover the universal tray and shelf with special baking parchment or greaseproof paper. .

Food	Level	Type of heating	Temperature in °C	Cooking time, hours
600 g of sliced apples	1+3		80	approximately 5 h
800 g of pears cut into chunks	1+3		80	approximately 8 h
1.5 kg of cherries	1+3		80	approximately 8-10 h
200 g of cleaned, fresh herbs	1+3		80	approximately 1½ h

Note: If the fruit or vegetables contain a lot of juice or water, they will have to be turned over several times. Once dried, remove them from the paper immediately.

Jam making

For cooking, the jars and the elastic bands must be clean and in perfect condition. Whenever possible, use jars of equal sizes. The values in the tables are given for round 1-Litre jars.

Caution!

Do not use larger or taller jars. Their lids could explode.
Only use fruit and vegetables that are in good condition. Clean them well.
The times given in tables are only given as an indication. These can vary according to the outside temperature, number of jars, quantity and temperature of the jar content. Before turning off the appliance, ensure the jars have begun to bubble.

Preparation

1. Tip the fruit or vegetable into the jars but do not fill them to the brim.
2. Clean the edges of the jars; these must be clean.

3. Place a cover and wet elastic band on each jar.
4. Close the jars with clamps.
Do not place more than six jars in the oven at the same time.

Setting

1. Place the universal tray on level 2. Place the jars on the tray so that they do not touch each other.
2. Pour ½ litre of water (approx. 80 °C) on the universal tray.
3. Close the oven door.
4. Position the control knob to bottom heat position .
5. Set the temperature between 170 and 180 °C.

Jam making

After approximately 40 - 50 minutes, bubbles begin to form rapidly. Switch the oven off

Take the jars out of the oven after approximately 25 - 35 minutes (the residual heat is used in this time). If these are allowed to cool in the oven for more time, this could promote the formation of germs making the jam acidic.

Fruit in 1 L jars	from when bubbles start to appear	Residual heat
Apples, gooseberries, strawberries	To switch off	approx. 25 minutes
Cherries, apricots, peaches, gooseberries	To switch off	approx. 30 minutes
Apple, pear or cherry puree	To switch off	approx. 35 minutes

Cooking vegetables

When small bubbles begin to form in the jars, adjust the temperature to approximately 120 - 140 °C.

About 35 - 70 minutes, depending on the type of vegetables.

After this time, turn off the oven to use the residual heat.

Cold cooking vegetables in 1 L jars	When bubbles start to appear 120-140 °C	Residual heat
Peppers	-	approx. 35 minutes
Beetroot	approx. 35 minutes	approx. 30 minutes
Brussels sprouts	approx. 45 minutes	approx. 30 minutes
Beans, kohlrabi, red cabbage	approx. 60 minutes	approx. 30 minutes
Peas	approx. 70 minutes	approx. 30 minutes

Remove the jars from the oven

Remove the jars from inside the oven when cooking is finished.

Caution!

Do not place hot jars on a cold or wet surface. They could explode.

Acrylamide in food

Acrylamide is produced particularly in cereal and potato products prepared at high temperatures, e. g., chips, toast, rolls, bread and pastries (biscuits, spiced biscuits, Christmas biscuits).

Tips for preparing food with a low acrylamide content

General	<ul style="list-style-type: none">■ Keep the cooking time to a minimum.■ Brown the food, making sure it is not overtoasted.■ Large, thick pieces of food contain a low acrylamide content.
Baking	With top and bottom heat max. 200 °C With 3D Hot air max. 180 °C.
Pastries and biscuits	With top and bottom heat max. 190 °C. With 3D Hot air max. 170 °C. Eggs or egg yolks reduce the formation of acrylamide.
Oven potato chips	Spread them evenly on a single layer in the baking tray. Bake at least 400 g on each baking tray so that the chips do not dry out

Test dishes

These tables have been produced for test institutes to facilitate the inspection and testing of the various appliances.

In accordance with EN 50304/EN 60350 (2009) and IEC 60350.

Baking

Baking on 2 levels:

Always place the universal deep tray on the upper level and the flat oven tray on the lower level.

Baking on 3 levels:

Always place the universal deep tray on the upper level.

Butter cookies:

Trays put in the oven at the same time are not necessarily ready at the same time.

Covered apple pie on level 1:

Place dark springform tins with some space between them.





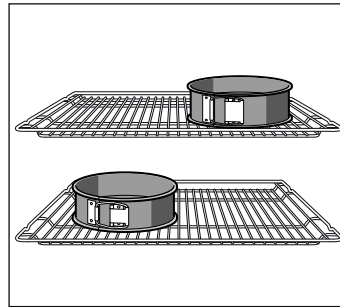









Covered apple pie on 2 levels:

Place dark springform tins on top of one another.



Cakes in springform tins:

Bake using top and bottom heating  on level 1. Use the universal tray instead of the wire shelf and place the springform tins on it.



Food	Accessories and tins	Level	Type of heating	Temperature in °C	Time in minutes
Butter cookies (preheating*)	Universal tray	3		150-160	20-30
	Universal tray	3		140-150	20-30
	Universal tray + oven tray	3+1		140-150	25-35
	2 oven trays + universal tray	5+3+1		140-150	25-35
Small cakes (pre-heating*)	Universal tray	3		150-170	20-30
	Universal tray + oven tray	3+1		140-160	25-35
	Universal tray	3		150-160	25-30
	2 oven trays + universal tray	5+3+1		140-150	25-30
Sponge cake (preheating*)	Springform tin on the wire shelf	2		170-180	30-40
Sponge cake	Springform tin on the wire shelf	2		165-175	35-45
Flat yeast cake	Universal tray	3		160-180	30-40
	Universal tray	3		140-160	35-45
	Universal tray + oven tray	3+1		160-170	30-40
Covered apple pie	Wire shelf + 2 springform tins Ø 20 cm.	1		190-210	70-90
	2 wire shelves + 2 springform tins Ø 20 cm.	3+1		170-190	60-80

* Do not use rapid heating to preheat the oven

Wire shelves and baking trays may be obtained as optional accessories from specialist retail outlets.

Grilling

If food is placed directly on the wire shelf, place the enamel tray at level 1. The tray will help keep the oven clean by catching any meat juices.

Food	Accessories	Level	Type of heating	Grill power	Time in minutes
Brown toast (preheat for 10 min.)	Shelf	5		3	½-2
12 beefburgers* (no pre-heating)	Grill + enamel tray	4+1		3	25-30

* Turn once after time ¾.



Robert Bosch Hausgeräte GmbH

Carl-Wery-Straße 34

81739 München

Germany

www.bosch-home.com



9000753082

02
940130

Free Manuals Download Website

<http://myh66.com>

<http://usermanuals.us>

<http://www.somanuals.com>

<http://www.4manuals.cc>

<http://www.manual-lib.com>

<http://www.404manual.com>

<http://www.luxmanual.com>

<http://aubethermostatmanual.com>

Golf course search by state

<http://golfingnear.com>

Email search by domain

<http://emailbydomain.com>

Auto manuals search

<http://auto.somanuals.com>

TV manuals search

<http://tv.somanuals.com>