

# Installation Instructions for the DS778 ASIC-Based Passive Infrared Intrusion Detector

## 1.0 Specifications

- **Input Power:** 6.0 VDC to 15.0 VDC; 18 mA @ 12.0 VDC
- **Standby Power:** There is no internal standby battery. Connect to DC power sources capable of supplying standby power if primary power fails. For each hour of standby time needed, 18 mAh are required. *For UL Certificated Installations, A minimum of 4 hours (72 mAh) is required.*
- **Coverage:** 200 ft. by 15 ft. (60 m by 4.5 m)
- **Sensitivity:** Adjustable for Intermediate or High.
- **Alarm Relay:** Form "C" reed relay with contacts rated at 28 VDC, 125 mA max. for DC resistive loads.
- **Tamper Switch:** Normally Closed (with cover in place) tamper switch. Contacts rated at 28 VDC, 125 mA max.
- **Temperature:** The storage and operating range is -40°F to +120°F (-40°C to +49°C). *For UL Certificated installations, the temperature range is +32°F to +120°F (0°C to +49°C).*
- **Options:** B328 Gimbal Mount Bracket, B335 Low Profile Mount Bracket, B338 Ceiling Mount Bracket, TC6000 Test Cord.

**Note:** Misalignment of the detector when using an optional mounting bracket may reduce range.

## 2.0 Mounting

### 2.1 Mounting Considerations

- Select a location that is most likely to intercept an intruder moving across the coverage pattern. The recommended mounting height range is 6.5 ft. to 8.5 ft. (2 m to 2.6 m).
- \* The mounting surface should be solid and vibration free.
- Avoid direct hot and/or cold drafts, direct sunlight, heat sources, windows, air conditioning outlets, and small animals.
- This detector **won't** detect through glass.
- See *Section 8.0 Coverage Patterns*.

### 2.2 Surface or Corner Mounting

**Note:** For bracket mounting, refer to the installations supplied with the bracket.

- Remove the cover. Insert a thin flathead screwdriver into the notch at the bottom of the cover and pry up.
- Remove the chassis screw in the upper right corner of the assembly (see *Figure A*). To remove the circuit board/mirror unit from the enclosure, push the circuit board/mirror unit toward the top of the enclosure until it clears its four retainer tabs, then lift out.

- Open two holes (see *Figure A*) for surface or corner mounting.

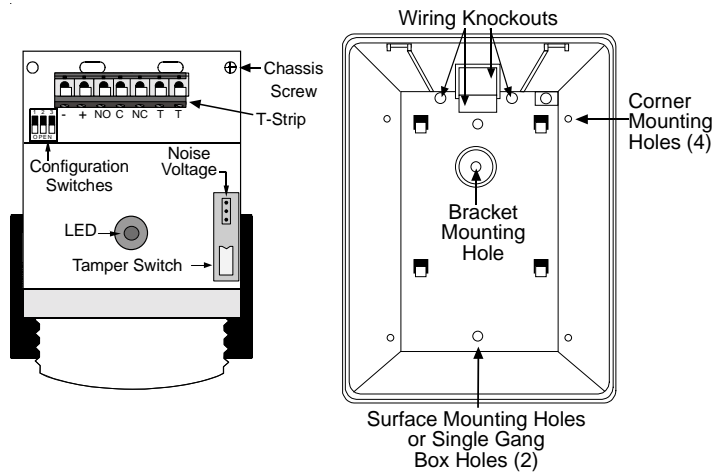

**Figure A - Location of Major Items - Circuit Board and Detector Enclosure**

- Mark the location for the mounting screws. Use the enclosure as a template. Pre-start the mounting screws.
- Open the appropriate wiring knockout and route the wiring through (see *Section 3.0 Wiring*).
- Securely attach the detector.
- Replace the circuit board/mirror unit.
- Adjust the mirror.

**Note:** Excessive handling of the mirror surfaces may lead to performance degradation.

- Adjust vertically from +2° to -18° by sliding the mirror forward or back. See *Figures B* and *C* to set the correct Vertical Angle based on the mounting height and desired range.

Mounting Height [ft. (m)]	Vertical Angle Setting	
	100 ft. (30 m)	200 ft. (60 m)
6.5 (2)	-2°	-1°
7.5 (2.3)	-2°	-2°
8.5 (2.6)	-3°	-2°

**Figure B - Mounting Height/Range Chart**

- The angle adjust markings are on the sides of the mirror (see *Figure C*).

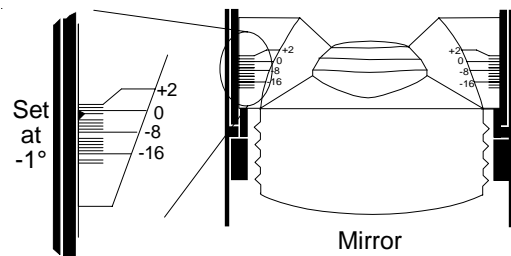

**Figure C - Setting Vertical Angle**

- Slide the mirror forward or back until the angle hash marks are in-line with the markers on each side of the frame.

- Horizontally  $\pm 10^\circ$  by rocking the mirror side to side.

When the detector is installed so that its pattern is centered down a narrow hallway, the coverage will probably not be adequate since the detector will be "looking" mostly at the walls leaving an open channel down most of the hallway as illustrated here:



Narrow Hallway  
Detector centered, Pattern centered

Depending on the dimensions of the hallway this can be compensated for by mounting it in the center and adjusting the horizontal angle as illustrated here:



Narrow Hallway  
Detector centered, Pattern rotated 1° (1 click)

- Walk test the installation carefully to ensure adequate coverage. See Figure D for horizontal angle adjustment information.

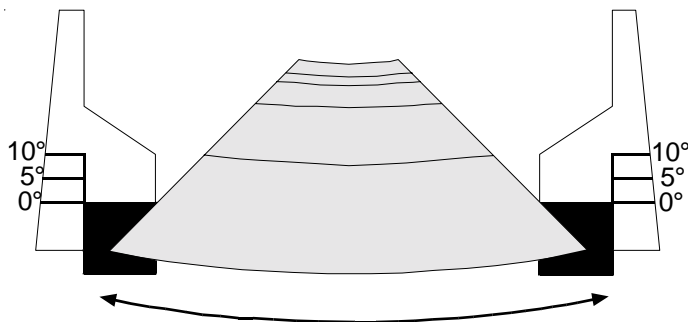

Figure D - Horizontal Angle Adjustment

### 3.0 Wiring



**Only apply power after all connections have been made and inspected.**

- Connect wiring as shown in Figure E.

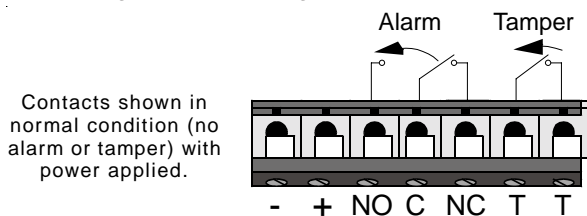

Figure E - Terminal Connections

- Seal the wire entrance with the foam plug provided.

### 3.1 Terminal Descriptions

- **1 (-) & 2 (+): Input Power (6 - 15 VDC).** Use no smaller than #22 AWG (0.8 mm) wire pair.
- **3 (NO), 4 (C), 5 (NC):** Relay Contacts. Reed relay for silent operation. Contacts rated at 3 watts, 125 mA, 28 VDC maximum for DC resistive loads and protected by a 4.7 ohm resistor in the common "C" leg of the relay. *Do not use with capacitive or inductive loads.*
- **6 & 7:** Normally Closed Tamper Contacts, rated 28 VDC, 125 mA.

### 4.0 Configuration Switches

- Configure the detector using the appropriate switch settings (see Figure F).

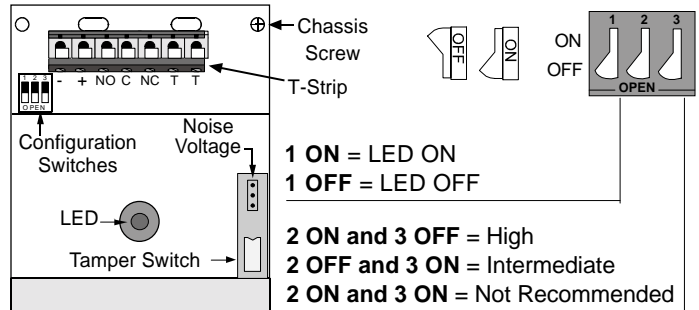

Figure F - Configuration Switch Locations

#### 4.1 LED Operation (S1)

- **ON:** Allows the LED to operate when activated by alarm.
- **OFF:** The LED will not operate on alarm.

#### 4.2 Sensitivity Mode (S2 and S3)

- **Intermediate Sensitivity:** Recommended setting for any location where an intruder is expected to cover only a portion of the protected area. Tolerates normal environments on this setting.
- **High Sensitivity:** Fast response to intruder signals. For use in quiet environments where thermal and illumination transients are not anticipated.

### 5.0 Setup and Walk Testing

- Replace the cover on the unit. The cover should be in place before testing the unit.
- Apply power to the detector.
- Wait for approximately two minutes, then start walk testing.
- Walk test across the coverage pattern as shown:
- The edge of the coverage is determined by activation of the LED.
- Walk test the unit from both directions to determine the boundaries.
- If the desired range **cannot** be achieved, try angling the mirror up or down to assure the coverage pattern is not aimed too high or low.

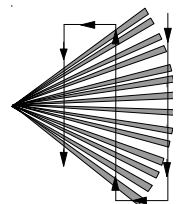

## 6.0 Final Tests

- Connect a DC VOM to the Noise Voltage pins (use TC6000).
- Replace the cover, routing the TC6000 cable through the notch in the top of the case.
- Set meter scale for about 3.0 VDC.
  - The base reference level for reading background noise is approximately 2.0 VDC.
  - Installations in quiet environments will result in a steady reading between 1.9 VDC and 2.1 VDC.
  - Voltage changes greater than 0.75 VDC from the reference level are desirable for good catch performance.
  - If changes are less than +0.75 VDC, the device may fail to respond if the temperature between the intruder and the background is minimal.
- Turn on all heating and cooling sources that would normally be in operation during times of protection.
- Stand away from the unit and outside the coverage pattern, then monitor the background noise for at least 3 minutes.
  - Readings should not deviate from the reference level by more than  $\pm 0.15$  VDC.
  - For readings outside these limits; eliminate the cause, re-point the unit slightly, or mask off the affected zones.

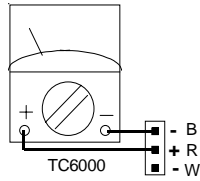

## 7.0 Maintenance

- At least once a year, the range and coverage should be checked in accordance with the Walk Testing section.
- To ensure continual daily operation, the end user should be instructed to daily walk through the outer edge of the coverage pattern. This assures an alarm output prior to arming.

## 8.0 Coverage Patterns

### Masking Information

Before attempting any masking, be sure the chosen mirror surface is the correct one (use the Mirror Segment to Pattern Reference illustration to determine the relationship between mirror sections and the pattern). When attempting to remove masking, many adhesives will either destroy the mirror surface or leave enough residue behind to reduce coverage performance.

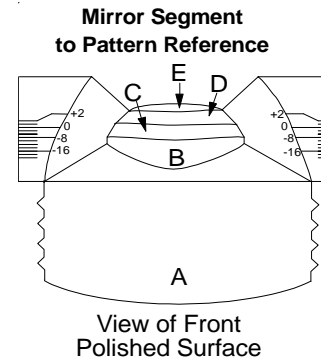

View of Front Polished Surface

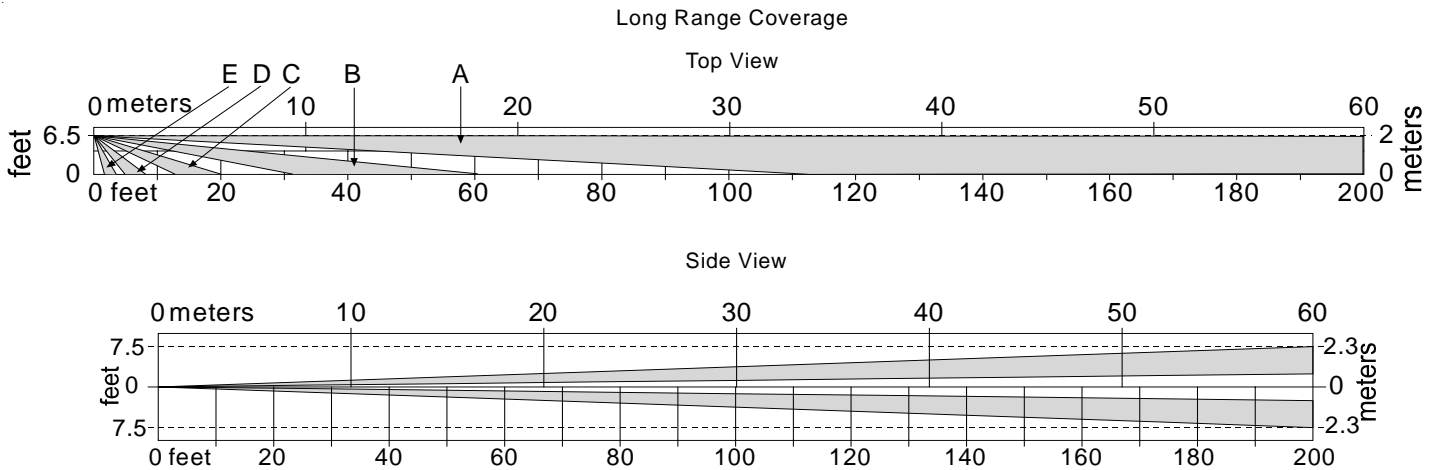



## Free Manuals Download Website

<http://myh66.com>

<http://usermanuals.us>

<http://www.somanuals.com>

<http://www.4manuals.cc>

<http://www.manual-lib.com>

<http://www.404manual.com>

<http://www.luxmanual.com>

<http://aubethermostatmanual.com>

Golf course search by state

<http://golfingnear.com>

Email search by domain

<http://emailbydomain.com>

Auto manuals search

<http://auto.somanuals.com>

TV manuals search

<http://tv.somanuals.com>