



# DINION IP starlight 8000 MP

NBN-80052



**BOSCH**

en Installation Manual



# Table of contents

<b>1</b>	<b>Safety</b>	<b>5</b>
1.1	Safety message explanation	5
1.2	Safety precautions	5
1.3	Important safety instructions	6
1.4	FCC and ICES compliance	7
1.5	Notices	8
<b>2</b>	<b>Short information</b>	<b>9</b>
<b>3</b>	<b>System overview</b>	<b>10</b>
3.1	Performance	10
3.2	Application variants	10
3.3	Using the camera	11
3.4	Operation with external systems	12
<b>4</b>	<b>Planning</b>	<b>14</b>
4.1	Unpacking	14
4.2	Contents	14
4.3	System requirements	15
<b>5</b>	<b>Installation</b>	<b>16</b>
5.1	Lens mounting	16
5.1.1	Lens connector	17
5.2	Mounting the camera	18
5.3	Local storage	19
<b>6</b>	<b>Connection</b>	<b>20</b>
6.1	Network (and PoE power)	20
6.2	Auxiliary power	21
6.3	Alarm	22
6.4	Audio	24
6.5	Video monitor	25
6.6	Data	26
<b>7</b>	<b>Configuration</b>	<b>27</b>
7.1	Setting up the camera	27
7.2	Local set-up	27
7.2.1	Field of view	28
7.2.2	Using the install wizard	28

---

7.3	Configuration via web browser	30
7.3.1	Set-up via web browser	31
7.4	True Day/Night switching	32
<b>8</b>	<b>Troubleshooting</b>	<b>33</b>
8.1	LED error status	33
8.2	Resolving problems	33
8.3	Testing the network connection	37
8.4	Customer service	37
8.5	Terminal program	38
<b>9</b>	<b>Maintenance</b>	<b>40</b>
9.1	Cleaning	40
9.2	Repair	40
9.3	Reset	41
<b>10</b>	<b>Decommissioning</b>	<b>42</b>
10.1	Transfer	42
10.2	Disposal	42
<b>11</b>	<b>Technical data</b>	<b>43</b>
11.1	Specifications	43
11.2	Dimensions	50

---

# 1 Safety

## 1.1 Safety message explanation

---



### Caution!

Indicates a hazardous situation which, if not avoided, could result in minor or moderate injury.

---



### Notice!

Indicates a situation which, if not avoided, could result in damage to the equipment or environment, or data loss.

---

## 1.2 Safety precautions

---



### Caution!

The Low Voltage power supply unit must comply with EN/UL 60950. The power supply must be a SELV-LPS unit or a SELV - Class 2 unit (Safety Extra Low Voltage - Limited Power Source).

---



### Caution!

Installation should only be performed by qualified service personnel in accordance with the National Electrical Code (NEC 800 CEC Section 60) or applicable local codes.

---



### Caution!

Use **only** a +12 VDC power supply as an auxiliary power source. The auxiliary power supply unit must be isolated from earth.

---

## 1.3 Important safety instructions

Read, follow, and retain for future reference all of the following safety instructions. Follow all warnings before operating the unit.

1. Clean only with a dry cloth. Do not use liquid cleaners or aerosol cleaners.
2. Do not install unit near any heat sources such as radiators, heaters, stoves, or other equipment (including amplifiers) that produce heat.
3. Never spill liquid of any kind on the unit.
4. Take precautions to protect the unit from power and lightning surges.
5. Adjust only those controls specified in the operating instructions.
6. Operate the unit only from the type of power source indicated on the label.
7. Unless qualified, do not attempt to service a damaged unit yourself. Refer all servicing to qualified service personnel.
8. Install in accordance with the manufacturer's instructions in accordance with applicable local codes.
9. Use only attachments/accessories specified by the manufacturer.

## 1.4 FCC and ICES compliance

### FCC & ICES Information

This equipment has been tested and found to comply with the limits for a **Class B** digital device, pursuant to *part 15* of the *FCC Rules*. These limits are designed to provide reasonable protection against harmful interference in a **residential installation**. This equipment generates, uses, and can radiate radio frequency energy and, if not installed and used in accordance with the instructions, may cause harmful interference to radio communications. However, there is no guarantee that interference will not occur in a particular installation. If this equipment does cause harmful interference to radio or television reception, which can be determined by turning the equipment off and on, the user is encouraged to try to correct the interference by one or more of the following measures:

- reorient or relocate the receiving antenna;
- increase the separation between the equipment and receiver;
- connect the equipment into an outlet on a circuit different from that to which the receiver is connected;
- consult the dealer or an experienced radio/TV technician for help.

Intentional or unintentional modifications, not expressly approved by the party responsible for compliance, shall not be made. Any such modifications could void the user's authority to operate the equipment. If necessary, the user should consult the dealer or an experienced radio/television technician for corrective action.

The user may find the following booklet, prepared by the Federal Communications Commission, helpful: *How to Identify and Resolve Radio-TV Interference Problems*. This booklet is available from the U.S. Government Printing Office, Washington, DC 20402, Stock No. 004-000-00345-4.

---

## 1.5 Notices

---

**Notice!**

Optical elements are sensitive and should be protected at all times. Do not allow objects to come into contact with glass surfaces and do not touch optical elements with your fingers.

---

**Notice!**

Video loss is inherent to digital video recording; therefore, Bosch Security Systems cannot be held liable for any damage that results from missing video information. To minimize the risk of losing information, we recommend multiple, redundant recording systems, and a procedure to back up all analog and digital information.

---

**Notice!**

We recommend that memory cards only be used for local storage of alarm recordings.

---



## 2 Short information

This manual has been compiled with great care and the information it contains has been thoroughly verified. The text was correct at the time of printing, however, the content can change without notice. Bosch Security Systems accepts no liability for damage resulting directly or indirectly from faults, incompleteness or discrepancies between this manual and the product described.

### **Trademarks**

All hardware and software product names used in this document are likely to be registered trademarks and must be treated accordingly.

### **More information**

For more information please contact the nearest Bosch Security Systems location or visit [www.boschsecurity.com](http://www.boschsecurity.com)

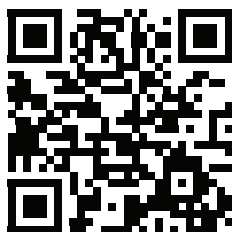

[http://www.boschsecurity.com/catalog\\_overview.htm](http://www.boschsecurity.com/catalog_overview.htm)

## 3 System overview

### 3.1 Performance

The DINION IP starlight 8000 MP offers a new standard in round-the-clock video surveillance. Regardless of lighting conditions, time-of-day or object movement, the camera delivers relevant IP video 24/7. Capturing 16:9 images at 5 megapixel resolution (3K) even under extreme low-light conditions, it gives amazing images in fine detail. The camera produces multi-megapixel full-color video in near darkness, and delivers detailed monochrome images where other cameras show no image at all.

This IP camera operates as a network video server to transmit video and control signals over Ethernet LANs and the Internet. The integrated encoder uses H.264 compression technology to give clear images while reducing bandwidth and storage requirements.

### 3.2 Application variants

The camera has a choice of application variants that set up the camera for optimum performance in a specific environment. Select the application variant best suited to your installation. The application variant must be selected before any other changes are made, as the camera reboots automatically and resets the factory defaults when the application variant is changed.

The DINION IP starlight 8000 MP has three application variants:

- 5MP (16:9)
- 5.5MP (4:3)
- 1080p

### **3.3 Using the camera**

To access the features of the camera, use a web browser. The browser provides live viewing of the camera streams in the interface window, and also allows you to access and change the extensive list of settings and parameters for camera configuration. Refer to the software manual for more information on the browser interface.

The camera recording and storage functions include local alarm recording and recording to iSCSI-based systems. The camera can also use the Bosch Video Recording Manager (VRM) to control recording and storage. Integration with the many Bosch recording solutions is seamless.

## 3.4 Operation with external systems

Using a web browser to access the camera's video streams and functions is the most direct way of using the camera. The Bosch Video Client can be downloaded and used for multiple-camera viewing, playback and configuration. A Bosch Video Security App is also available for remote viewing. If the camera is used in larger surveillance systems, the Bosch Video Management System offers a perfect integrated solution. Third-party integrators can easily access the internal feature set of the camera for integration into large projects. Access to IVA metadata is available to integrators via RTSP.

When connected to external systems, many of the camera configuration parameters are controlled by the system and not by the settings made via a web browser.

### **Bosch Video Client**

The Bosch Video Client is a free Windows application to view, operate, control, and administer surveillance cameras and installations at remote locations. It offers a user-friendly interface for easy live viewing of multiple cameras, playback, forensic search and export.

### **Video Security Client**

The Video Security Client is a free, easy-to-use video-surveillance application provided by Bosch for local and remote monitoring of IP cameras and appliances. The software supports systems up to 16 cameras.

### **IP Helper**

The IP Helper tool is a free PC application that makes it easy to detect Bosch cameras and devices on your network.

### **Download store**

Download the latest applications and firmware from:  
<http://downloadstore.boschsecurity.com/>

### **Bosch Video Management System**

The Bosch Video Management System is a unique enterprise IP video surveillance solution that provides seamless management of digital video, audio and data across any IP network. It is designed to work with Bosch security products as part of a total video surveillance management system.

---

## 4 Planning

### 4.1 Unpacking

This equipment should be unpacked and handled with care. If an item appears to have been damaged in shipment, notify the shipper immediately.

Verify that all parts are included. If any items are missing, notify your Bosch Security Systems Sales or Customer Service Representative.

The original packaging is the safest container in which to transport the unit and can be used if returning the unit for service.

### 4.2 Contents

The packaging contains:

- DINION IP 8000 camera
- Quick install instructions
- Power connector
- Data/Alarm connector
- Identification labels
- C/CS mount adapter ring for mounting a lens with a C-mount (not supplied for factory fitted lenses)

---

## 4.3 System requirements

To enjoy the full benefits of megapixel resolutions, ensure that the computer, the graphic adapter, the display connections, and the monitor are sufficiently powerful to view our camera images at their best.

Our minimum recommendations are:

- Computer with Dual core HyperThreading processor or better
- 4K capable graphic card
- Windows 7 or later operating system
- Network access
- Internet Explorer version 11 or later

**- or -**

Application software, for example, Video Security Client, Bosch Video Client or Bosch Video Management System.



### Notice!

Megapixel cameras can generate high bitrate streams. Ensure that your network can handle high volume traffic and that you use a powerful, high performance computer.

---

## 5 Installation

### 5.1 Lens mounting

**Notice!**

Do not try to adjust a factory-fitted lens.

Do not allow dust to get onto the sensor or lens surface.

Lenses weighing more than 0.5 kg (1.1lbs) must be separately supported.

To attach a lens to the camera:

1. Remove the sensor protection cap from the camera.
2. For C-mount lenses, screw the C/CS lens adapter ring onto the camera.
3. Screw the lens onto the camera.

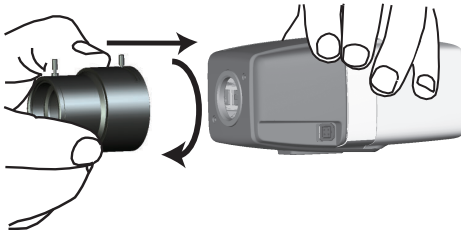



### 5.1.1 Lens connector

Plug the lens connector into the camera (it automatically detects the type of lens).

If a short circuit is detected on the lens connector, the lens circuit is automatically disabled to avoid internal damage. In this case, remove the lens connector and check the pin connections.

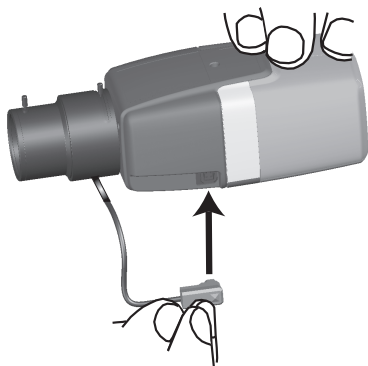

Pin	DC iris lens
1	Damp -
2	Damp +
3	Drive +
4	Drive -

## 5.2 Mounting the camera



**Notice!**

Do not expose the image sensors to direct sunlight.  
Do not obstruct the free flow of air around the camera.

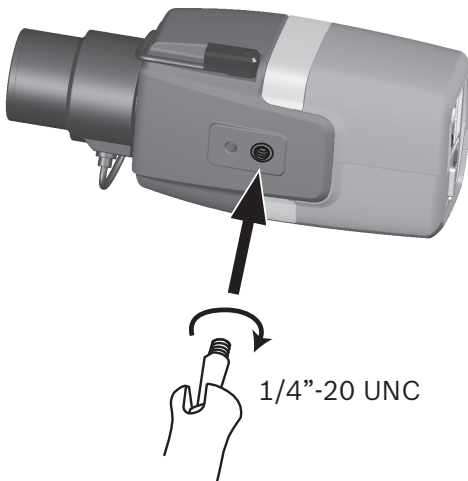

The camera can be mounted either from the top or from the bottom (1/4" 20 UNC thread).

## 5.3 Local storage

### Notice!



Local storage on SD cards should only be used for alarm recording. To minimize the risk of losing information, use multiple, redundant recording systems and a procedure to back up all digital information.

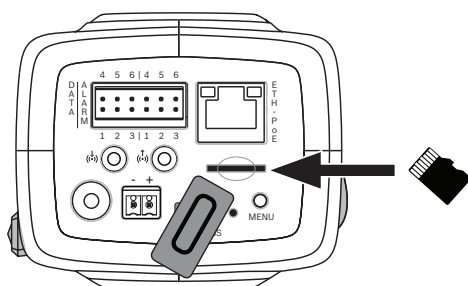

1. Unscrew the card slot cover.
2. Slide the memory card into the slot until it locks in place.
3. Screw the cover into place to seal the slot.

## 6 Connection

### 6.1 Network (and PoE power)

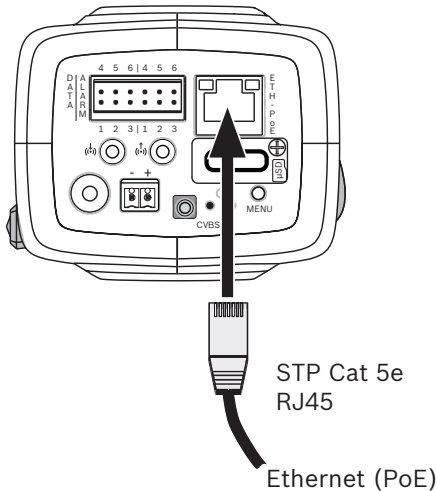

Connect the camera to a 10/100 Base-T network:

- Use STP Category 5e cable with RJ45 connectors (the camera network socket is Auto MDIX compliant).
- Power can be supplied to the camera via the Ethernet cable compliant with the Power-over-Ethernet standard.

The LEDs beside the Ethernet connection indicate network connection (green lit) and IP traffic (orange flashing).



#### Notice!

Use only PoE approved devices.

Power-over-Ethernet can be connected at the same time as a 12 VDC power supply. If auxiliary power (12 VDC) and PoE is applied simultaneously, the camera selects PoE and shuts off the auxiliary input.

## 6.2 Auxiliary power



### Caution!

The Low Voltage power supply unit must comply with EN/UL 60950. The power supply must be a SELV-LPS unit or a SELV - Class 2 unit (Safety Extra Low Voltage - Limited Power Source).



### Caution!

Use **only** a +12 VDC power supply as an auxiliary power source. The auxiliary power supply unit must be isolated from earth.

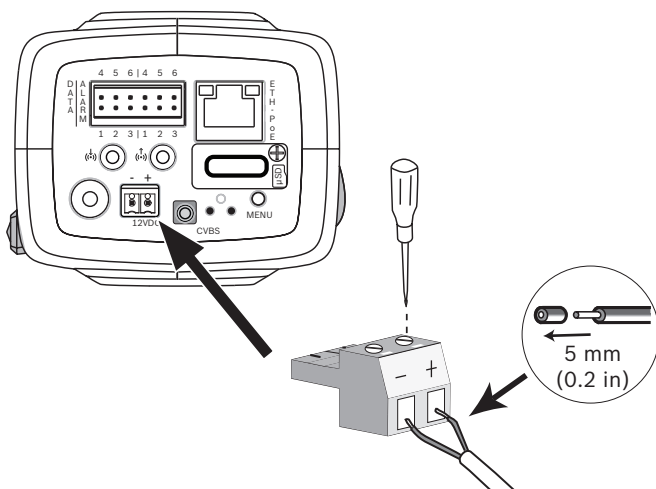

Connect an approved power supply unit with a rated supply voltage of 12 VDC as follows:

1. Strip back 5 mm (0.2 in) of insulation on the power supply cable (must be 16-22 AWG stranded wire or 16-26 AWG solid wire).
2. Loosen the screws of the supplied 2-pole connector and insert the stripped wires, then tighten the screws again.
3. Insert the 2-pole connector into the camera power socket.

## 6.3 Alarm

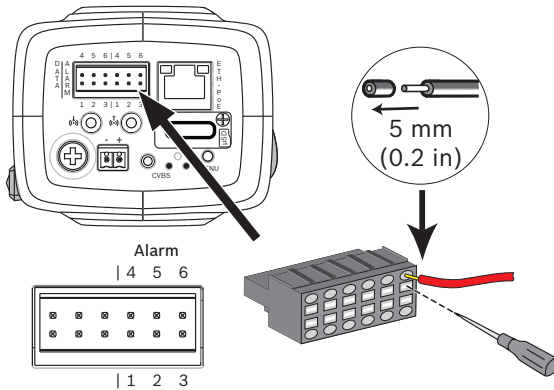

Pin	Alarm socket
1	Alarm in 1
2	Alarm in 2
3	Alarm out contact 1
4	Ground
5	Ground
6	Alarm out contact 2

The maximum wire diameter is AWG 22-28 for both stranded and solid; cut back 5 mm (0.2 in) of insulation.

### Alarm out

Use the alarm output for switching external devices such as lamps or sirens.

Alarm output switching capability:

- Max. voltage 30 VAC or +40 VDC. Max. 0.5 A continuous, 10 VA.

**Alarm in:**

Use the alarm input to connect external alarm devices such as door contacts or sensors:

- TTL logic, +5 V nominal, +40 VDC max, DC coupled with 50 kOhm pull-up to +3.3 V.
- Configurable as active low or active high.

A zero potential make-contact or switch can be used as the actuator (use a bounce-free contact system).

**Note:**

If IR illumination is used, the alarm interface provides a stable switching control of the day/night function of the camera.

## 6.4 Audio

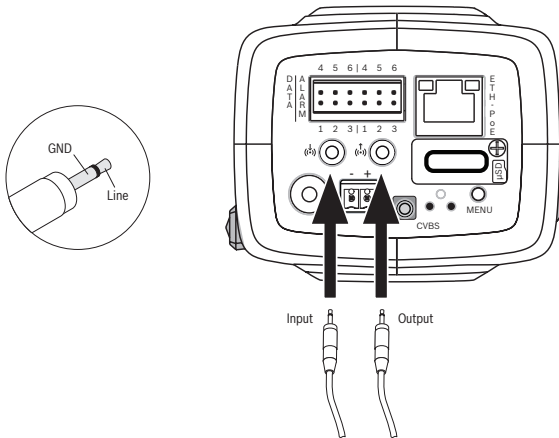

Connect audio devices to the **Audio In** and **Audio Out** connectors.

The unit has full-duplex mono audio for two-way communication between a speaker or door intercom system. The audio input signal is transmitted in sync. with the video signal.

**Audio input:** Line input level (not suitable for direct microphone signal); impedance 18 kOhm typical; 1 Vrms maximum input voltage.

**Audio output:** Line output level (not suitable for direct speaker connection); impedance 1.5 kOhm minimum; 0.85 Vrms maximum output voltage.

**Wiring:** Use shielded audio connection cable with advised maximum cable lengths for audio line input and output levels.



## 6.5 Video monitor

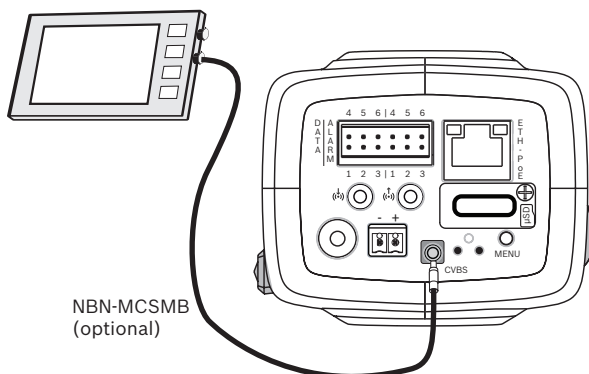

Use the SMB video connector (CVBS) to connect an analog monitor for setting up the camera:

- To connect a monitor, use the optional 3 m cable (NBN-MCSMB-30M) to connect directly to the CVBS connector of a monitor.
- To connect to a coax cable, use the optional 0.3 m cable (NBN-MCSMB-03M).

## 6.6 Data

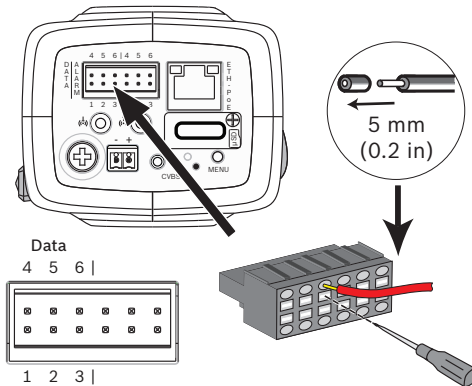

Pin	Data socket
1	Ground
2	RxD / Rx+
3	Rx-
4	Ground
5	TxD / Tx-
6	Tx+

Use the data connector to connect to an external device for sending control data from the camera to the external device. This data connection supports RS485, RS422, and RS232.

### Note:

To ensure surge and electrostatic protection, keep the cable length between the camera and external device to less than 3 meters.

## 7 Configuration

### 7.1 Setting up the camera

Configure the settings (such as application variant, focus and picture orientation) using one of the following methods:

- use the **Menu** button on the camera to step through the basic camera settings.
- open the camera in a web browser and select **Configuration >> Camera >> Installer Menu** – with this method you can also change other parameters.



#### Notice!

Changing the application variant overwrites your camera settings with the factory defaults.

### 7.2 Local set-up

For local set-up, connect a monitor to the CVBS output of the camera. To view the local set-up menu on the monitor, briefly press the **Menu** button.

To make a choice in the menu, press the **Menu** button for a short time (less than 2 s) or for a longer time.

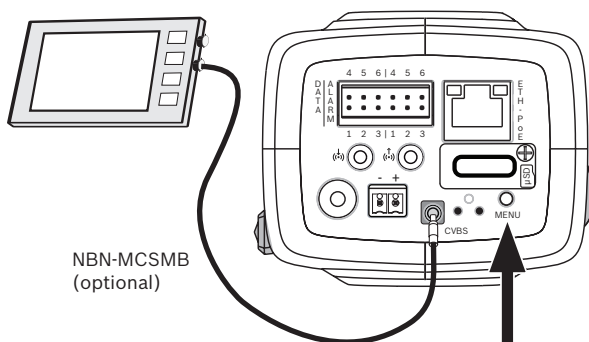

NBN-MCSMB  
(optional)

## 7.2.1 Field of view

Use the monitor image to manually point the camera at the area to be covered.

## 7.2.2 Using the install wizard

### DINION IP starlight 8000 MP

1. Power-up the camera and wait momentarily for it to start.
2. Briefly press the **MENU** button to open the wizard and display the following screen on the monitor:

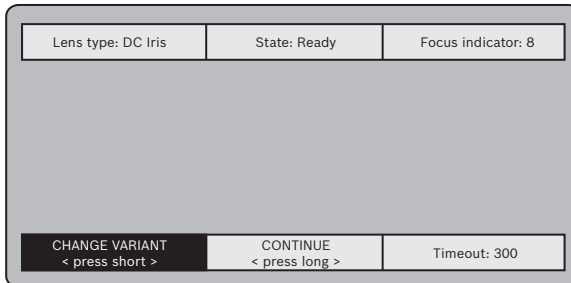

The lens type is identified and shown on the screen.

The iris is opened to its maximum value.

3. If required, change the camera application variant as follows:  
Briefly press **MENU** until the required variant is displayed.  
Choices are 1080p, 5MP (4:3) or 5MP (16:9).  
Assign the setting by pressing **MENU** for a longer time.  
Confirm the setting by pressing **MENU** for a longer time.  
The camera reboots and assigns the factory defaults for that variant.
4. When the variant is set correctly, briefly press **MENU** to continue to the following screen:

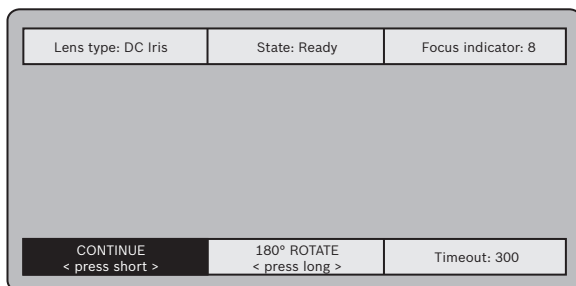

- To rotate the image 180°, press **MENU** for a longer time until the image flips.
- Briefly press **MENU** to continue.
- Briefly press **MENU** to center the focus.
- Manually adjust the focal length lever on the lens to obtain the required field of view.

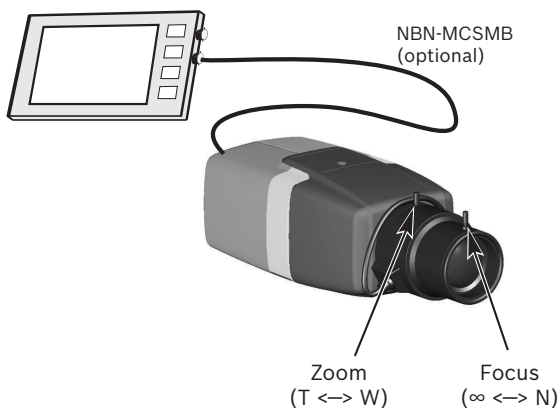

- Manually adjust the focus lever on the lens to obtain the sharpest image possible.
- Briefly press **MENU** to start the automatic back focus adjustment (AUTO BACK FOCUS).  
The motorized automatic back focus process runs.  
The progress is shown on the monitor.
- If the camera is not in focus, press **MENU** for a longer time to restart the wizard.
- If the camera is correctly focused, briefly press **MENU** to exit the wizard.

## 7.3 Configuration via web browser

The unit must have a valid IP address and a compatible subnet mask to operate on your network. By default, DHCP is pre-set at the factory to **On** and so your DHCP server assigns an IP address. With no DHCP server the default address is 192.168.0.1

To view the camera in your web browser:

1. Start the Web browser.
2. Enter the IP address of the unit as the URL.
3. During initial installation, confirm any security questions that appear.

### **Note:**

To see live images in your browser it might be necessary to download and install the MPEG-ActiveX from the Bosch download store.

### **IP Helper tool**

Alternatively, use the IP Helper tool to detect Bosch devices on the network:

1. Select a camera
2. Click **Open in browser** to view the camera interface.

### **Protected network**

If a RADIUS server is used for network access control (802.1x authentication), the unit must be configured first. To configure the unit, connect it directly to a computer using a network cable and configure the two parameters, **Identity** and **Password**. Only after these have been configured can communication with the unit via the network occur.

### 7.3.1 Set-up via web browser

1. Open the camera in the web browser.
2. Click **Configuration** in the title bar.
3. Select **Camera >> Installer Menu** from the side bar.
4. Click the **Lens Wizard** button and follow the steps to configure the lens.

If required, configure the other parameters to suit your working environment (for example, ID, passwords, date and time). Refer to the operation manuals of the software for more information.

## 7.4 True Day/Night switching

The camera is equipped with a motorized IR filter. This mechanical IR filter is taken out of the optical path in low-light conditions.

The IR filter is controlled either:

- via an alarm input, or
- automatically, based on the observed light levels.

If **Auto** switching mode is selected, the camera automatically switches the filter depending on the observed light level. The switching level is adjustable. (If the day to night switching level is set to -15, certain borderline scene lighting conditions can cause the camera to switch back and forth between day and night modes. Set a different switching level to avoid this.)

**Note:**

If IR illumination is used, the alarm interface provides a stable switching control for the day/night function of the camera.



## 8 Troubleshooting

### 8.1 LED error status

The camera has four LEDs on the rear panel:

- Two LEDs indicate the camera status (red for error; green for OK)
- Two LEDs (green and orange) beside the network connection indicate the LAN and PoE status

### 8.2 Resolving problems

The following table is intended to help identify the causes of malfunctions and correct them where possible.

Malfunction	Possible causes	Solution
No image transmission to remote location.	Defective camera.	Connect a local monitor to the camera and check the camera function.
	Faulty cable connections.	Check all cables, plugs, contacts and connections.
	Incorrect encoder stream property set for connection to hardware decoder.	Select the H.264 MP SD option on the <b>Encoder Streams</b> configuration page.
No connection established, no image transmission.	Incorrect unit configuration.	Check all configuration parameters (reset to factory default if necessary).

Malfunction	Possible causes	Solution
	Faulty installation.	Check all cables, plugs, contacts and connections.
	Wrong IP address.	Check the IP addresses (terminal program).
	Faulty data transmission within the LAN.	Check the data transmission with ping.
	The maximum number of connections has been reached.	Wait until there is a free connection and call the transmitter again.
No audio transmission to remote station.	Hardware fault.	Check that all connected audio units are operating correctly.
	Faulty cable connections.	Check all cables, plugs, contacts and connections.
	Incorrect configuration.	Check audio parameters on the <b>Audio</b> configuration and <b>LIVE</b> page functions pages.
	The audio voice connection is already in use by another receiver.	Wait until the connection is free and then call the sender again.

<b>Malfunction</b>	<b>Possible causes</b>	<b>Solution</b>
The unit does not report an alarm.	Alarm source is not selected.	Select possible alarm sources on the Alarm sources configuration page.
	No alarm response specified.	Specify the desired alarm response on the Alarm connections configuration page; if necessary change the IP address.
Control of cameras or other units is not possible.	The cable connection between the serial interface and the connected unit is not correct.	Check all cable connections and ensure all plugs are properly fitted.
	The interface parameters do not match those of the other unit connected.	Make sure that the settings of all units involved are compatible.
The unit is not operational after a firmware upload.	Power failure during programming by firmware file.	Have the unit checked by Customer Service and replace if necessary.
	Incorrect firmware file.	Enter the IP address of the unit followed by /main.htm in your Web browser and repeat the upload.

<b>Malfunction</b>	<b>Possible causes</b>	<b>Solution</b>
Placeholder with a red cross instead of the ActiveX components.	JVM not installed on your computer or not activated.	Install JVM.
Web browser contains empty fields.	Active proxy server in network.	Create a rule in the local computer's proxy settings to exclude local IP addresses.
The camera LED flashes red.	Firmware upload failed.	Repeat firmware upload.

## 8.3 Testing the network connection

The ping command can be used to check the connection between two IP addresses. This allows testing whether a device is active in the network.

1. Open the DOS command prompt.
2. Type `ping` followed by the IP address of the device.

If the device is found, the response appears as "Reply from ... ", followed by the number of bytes sent and the transmission time in milliseconds. Otherwise, the device cannot be accessed via the network. This might be because:

- The device is not properly connected to the network. Check the cable connections in this case.
- The device is not correctly integrated into the network. Check the IP address, subnet mask, and gateway address.

## 8.4 Customer service

If a fault cannot be resolved, please contact your supplier or system integrator, or go directly to Bosch Security Systems Customer Service.

The version numbers of the internal firmware can be viewed on a service page. Please note this information before contacting Customer Service.

1. In the address bar of your browser, after the unit IP address, enter: `/version`  
for example: `192.168.0.80/version`
2. Write down the information or print out the page.

## 8.5 Terminal program

### Data Terminal

If a camera cannot be found in the network or the connection to the network is interrupted, you can connect a data terminal to the camera for initial setup and for setting important parameters. The data terminal consists of a computer with a terminal program.

You require a serial transmission cable with a 9-pin Sub-D plug to connect to the computer.

The communications accessory included with Windows can be used as the terminal program.

1. Disconnect the camera from the Ethernet network before working with the terminal program.
2. Connect the serial interface of the camera using any available serial interface on the computer.

### Configuring the Terminal

Before the terminal program can communicate with the camera, the transmission parameters must be matched. Make the following settings for the terminal program:

- 19,200 bps
- 8 data bits
- No parity check
- 1 stop bit
- No protocol

### Command Inputs

After the connection has been established, you must log on to the camera to access the main menu. Other submenus and functions can be accessed using the on-screen commands.

1. If necessary, turn off the local echo so that entered values are not repeated on the display.
2. Enter one command at a time.
3. When you have entered a value, such as the IP address, check the characters you have entered before pressing Enter to transfer the values to the camera.

## Assigning an IP Address

Before you can operate a camera in your network you must first assign it an IP address that is valid for your network.

The following default address is preset at the factory:

### 192.168.0.1

1. Start a terminal program such as HyperTerminal.
2. Enter the user name service. The terminal program displays the main menu.
3. Enter command 1 to open the IP menu.
4. Enter 1 again. The terminal program displays the current IP address and prompts you to enter a new IP address.
5. Enter the desired IP address and press Enter. The terminal program displays the new IP address.
6. Use the displayed commands for any additional settings you require.

### Note:

You must reboot to activate the new IP address, a new subnet mask, or a gateway IP address.

## Reboot

Briefly interrupt the power supply to the camera for a reboot (disconnect the power supply and switch on again after a few seconds).

## Additional Parameters

Use the terminal program to check other basic parameters and modify them where necessary. Use the on-screen commands in the various submenus to do this.

---

## 9 Maintenance

### 9.1 Cleaning

#### Camera cleaning

It is generally sufficient to use a dry cloth for cleaning, but a moist lint-free cloth or leather shammy may also be used.

Do not use liquid cleaners or aerosol cleaners.

#### Lens cleaning

It is important to keep the lens clean to ensure optimum performance. Dust, grease, or fingerprints should be removed from the lens surface. When cleaning the lens, take extra care not to damage the special coating used to reduce light reflections.

- Remove dust with a blower-brush or grease-free soft brush.
- Wipe water drops off the lens with a clean soft lint-free cloth and dry the lens surface.
- Use special lens cleaning paper or cloth treated with lens cleaning fluid to gently wipe off any remaining dirt (wipe spirally from the lens center towards the edge).

### 9.2 Repair



#### Notice!

Never open the casing of the unit

---

The unit does not contain any user-serviceable parts. Refer all repairs to suitable qualified specialists.



## 9.3 Reset

Use the factory reset button to restore the unit to its original settings. Any changes to the settings are overwritten by the factory defaults. A reset may be necessary, for example, if the unit has invalid settings that prevent it from functioning as desired.

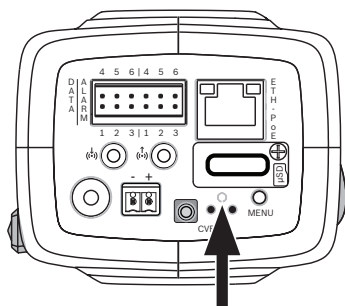

## 10 Decommissioning

### 10.1 Transfer

The camera should only be passed on together with this installation guide.

### 10.2 Disposal



**Disposal** - Your Bosch product was developed and manufactured with high-quality material and components that can be recycled and reused. This symbol means that electronic and electrical appliances, which have reached the end of their working life, must be collected and disposed of separately from household waste material. Separate collecting systems are usually in place for disused electronic and electrical products. Please dispose of these units at an environmentally compatible recycling facility, per *European Directive 2012/19/EU*.

# 11 Technical data

## 11.1 Specifications

<b>Power</b>	
Power Supply	12 VDC; Power-over-Ethernet 48 VDC nominal
Current Consumption	750 mA (12 VDC); 200 mA (PoE 48 VDC)
Power Consumption	9 W
PoE	IEEE 802.3af (802.3at Type 1) Class 3

<b>Sensor</b>	
Type	1/1.8" CMOS
Total sensor pixels	6.1 MP

<b>Video performance - Dynamic range</b>	
5.5MP (4:3) mode	97 dB WDR (97+16 dB with IAE)
5MP (16:9) mode	97 dB WDR (97+16 dB with IAE)
1080p mode	103 dB WDR (103+16 dB with IAE)

<b>Video performance – Sensitivity (3200K, 89% reflectivity, 30% IRE, F1.2)</b>	
Color 5MP mode	0.0121 lx
Color 1080p mode	0.00825 lx
Mono 5MP mode	0.004 lx
Mono 1080p mode	0.00275 lx

<b>Video streaming</b>	
Video compression	H.264 (MP); M-JPEG
Streaming	Multiple configurable streams in H.264 and M-JPEG, configurable frame rate and bandwidth. Regions of Interest (ROI)
Overall IP Delay	Min. 120 ms, Max. 340 ms
GOP structure	IP, IBP, IBBP
Encoding interval	1 to 30 [25] fps
Encoder regions	Up to 8 areas with encoder quality settings per area

<b>Video resolution</b>	
5MP (16:9)	2992 X 1680
5.5MP (4:3)	2704 X 2032
1080p HD	1920 X 1080
720p HD	1280 x 720
Upright 9:16 (cropped)	400 x 720

<b>Video resolution</b>	
D1 4:3 (cropped)	704 x 480
480p SD	Encoding: 704 x 480; Displayed: 854 x 480
432p SD	768 x 432
288p SD	512 x 288
240p SD	Encoding: 352 x 240; Displayed: 432 x 240
144p SD	256 x 144

<b>Video functions</b>	
Day/Night	Color, Monochrome, Auto (adjustable switchover points)
Adjustable picture settings	Contrast, Saturation, Brightness
White Balance	2500 to 10000K, 4 automatic modes, manual mode and measure
Shutter	Automatic Electronic Shutter (AES) Fixed (selectable) Default shutter
Backlight compensation	Off, Auto, Intelligent Auto Exposure
Noise reduction	Intelligent Dynamic Noise Reduction with separate temporal and spatial adjustments
Contrast enhancement	On/off
Sharpness	Sharpness enhancement level selectable

<b>Video functions</b>	
Intelligent defog	Intelligent Defog automatically adjusts parameters for best picture in foggy or misty scenes (switchable)
Privacy Masking	Eight independent areas, fully programmable
Video Motion Analysis	Intelligent Video Analysis
Scene modes	Nine pre-defined modes
Other functions	Image flip, Pixel counter, Video watermarking, Display stamping, Positioning

<b>Audio streaming</b>	
Standard	G.711, 8 kHz sampling rate L16, 16 kHz sampling rate AAC-LC, 48 kbps at 16 kHz sampling rate AAC-LC, 80 kbps at 16 kHz sampling rate
Signal-to-Noise Ratio	>50 dB
Audio Streaming	Full-duplex / half duplex

<b>Input/output</b>	
Analog video out	SMB connector, CVBS (PAL/NTSC), 1 Vpp, 75 Ohm
Audio line in	1 Vrms max, 18 kOhm typical,
Audio line out	0.85 Vrms at 1.5 kOhm typical,

<b>Input/output</b>	
Audio connectors	3.5 mm mono jack
Alarm input	2 inputs
Alarm input activation	+5 VDC nominal; +40 VDC max. (DC-coupled with 50 kOhm pull-up resistor to +3.3 VDC) (< 0.5 V is low; > 1.4 V is high)
Alarm output	1 output
Alarm output voltage	30 VAC or +40 VDC max. Maximum 0.5 A continuous, 10VA (resistive load only)
Ethernet	RJ45
Data port	RS-232/422/485

<b>Local storage</b>	
Internal RAM	10 s pre-alarm recording
Memory card slot	Supports up to 32 GB microSDHC / 2 TB microSDXC card. (An SD card of Class 6 or higher is recommended for HD recording)
Recording	Continuous recording, ring recording, alarm/events/schedule recording

<b>Network</b>	
Protocols	IPv4, IPv6, UDP, TCP, HTTP, HTTPS, RTP/RTCP, IGMP V2/V3, ICMP, ICMPv6, RTSP, FTP, Telnet, ARP, DHCP, NTP (SNTP), SNMP (V1, MIB-II), 802.1x, DNS, DNSv6, DDNS (DynDNS.org, selfHOST.de, no-ip.com), SMTP, iSCSI, UPnP (SSDP), DiffServ (QoS), LLDP, SOAP, Dropbox, CHAP, digest authentication
Encryption	TLS 1.0, SSL, DES, 3DES, AES (optional)
Ethernet	10/100 Base-T, auto-sensing, half/full duplex
Connectivity	ONVIF Profile S , Auto-MDIX

<b>Software</b>	
Unit Configuration	Via web browser or Configuration Manager
Firmware update	Remotely programmable
Software viewer	Web browser, Bosch Video Client, or third party software

<b>Optical</b>	
Lens mount	CS mount (C-mount with adapter ring)
Lens connector	Standard 4-pin DC-iris connector
Focus control	Motorized back-focus adjustment
Iris control	Automatic iris control



<b>Mechanical</b>	
Dimensions (W x H x L)	78 x 66 x140 mm (3.07 x 2.6 x 5.52 inch) without lens
Weight	855 g (1.88 lb) without lens
Color	RAL 9006 Metallic Titanium
Tripod Mount	Bottom and top 1/4-inch 20 UNC

<b>Environmental</b>	
Operating Temperature	-20°C to +50°C (-4°F to 122°F)
Storage Temperature	-30°C to +70°C (-22°F to +158°F)
Operating Humidity	20% to 93% RH
Storage Humidity	up to 98% RH

## 11.2 Dimensions

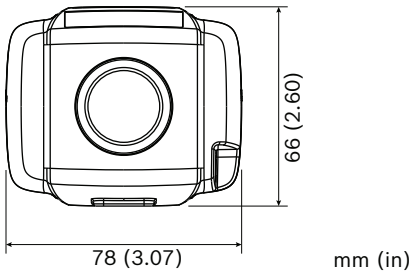
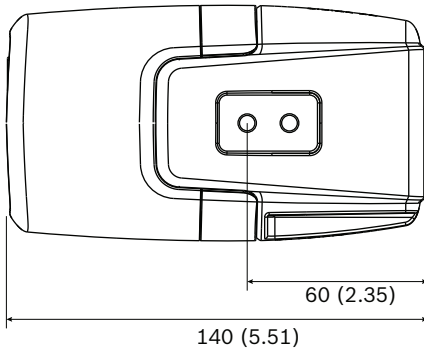



**Bosch Security Systems B.V.**

Torenallee 49

5617 BA Eindhoven

Netherlands

**[www.boschsecurity.com](http://www.boschsecurity.com)**

© Bosch Security Systems B.V., 2016

## Free Manuals Download Website

<http://myh66.com>

<http://usermanuals.us>

<http://www.somanuals.com>

<http://www.4manuals.cc>

<http://www.manual-lib.com>

<http://www.404manual.com>

<http://www.luxmanual.com>

<http://aubethermostatmanual.com>

Golf course search by state

<http://golfingnear.com>

Email search by domain

<http://emailbydomain.com>

Auto manuals search

<http://auto.somanuals.com>

TV manuals search

<http://tv.somanuals.com>