

 **BLAUPUNKT**



VELOCITY POWER
CLASS D AMPLIFIER
with DSP **MPD 46 A**



Enjoy it.

Operating and Installation Instructions

CAUTIONS

This device has been manufactured according to established safety guidelines. However, dangers may still occur if the safety notes in this manual is not observed. This manual is intended to familiarize the user with the device's important functions. Read this carefully, prior to using the car radio. Keep this manual in an easily accessible location. In addition, do observe the instructions of other devices used in conjunction with this device.

Installation Safety Notes

Always observe the following safety notes:

- Device must be used in a way that compliments safety of the user when driving the vehicle. It is recommended for the user to install at an appropriate location when operating the device. While driving, user is not recommended to use applications that can be prone to distraction.
- Before installation, disconnect the negative terminal of the battery. Refer to the safety vehicle manufacturer's user manual.
- Ensure positions of the holes are nowhere near the vehicle component to avoid any damage during drilling.
- Ensure cross section of the cables is no less than 2.5mm if the positive and the negative cables are too long. Incorrect installation may result in malfunction of the device or the car sound system.
- Select a dry and well-ventilated location to install the device.
- The device must not be installed in overly exposed location.
- The installation location must be suitable for screw holes and stable ground support

General Safety Notes:

Observe the following for protection against injuries:

- User is advised to keep the volume of the car radio to a moderate level for the protection of the ears and to increase the ability to hear any emergency warning signals (e.g. police and ambulance sirens). Do not increase the car radio volume while the car radio is muted as it is not audible. The car radio volume can be too loud when the car radio is unmuted.

Disclaimer

- Blaupunkt is not liable for any loss or damage caused or resulting from unauthorized disassembly or modification to the product.
- In no event shall Blaupunkt be liable for any direct, indirect, punitive, incidental, special consequential damages, to property or life, improper storage, whatsoever arising out of or connected with the use or misuse of our products.
- USA & CANADA : Products not intended for sales in the United States and Canada. If purchased in the U.S. or Canada, this product is purchased as-is. No warranty, expressed or implied is provided in the U.S. and Canada.

Voltage Supply

- +12V : Positive connection terminal for car 12V power supply.
- GND : Power supply negative connection terminal.
- Firmly and carefully connect the ground lead to a bare metal point on the vehicle chassis.
- Operation temperature : 0° - 70°C

Compatible PC OS

- PC - with or higher than Windows XP
- Android - mainstream Android devices with Bluetooth

Scope of Delivery

- DSP Digital Signal Processor (153 x 112 x 45mm)
- 1.5m USB Cable
- 2 Tapping Screws (M3 x 10)
- Universal 20p Wiring Harness

Disposal Notes



Do not dispose of your old unit in the household trash!
Use the return and collection systems available to dispose of the old device.

INPUT FUNCTION

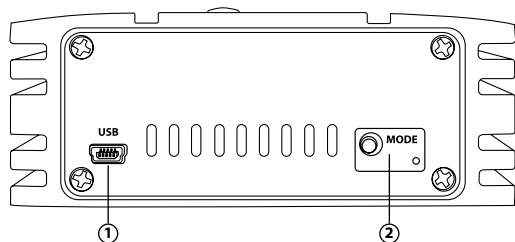

1. Connect to computer for software tuning.
2. Press the button to select the preferable mode. (There are maximum 6 sound effect modes can be saved by using software).

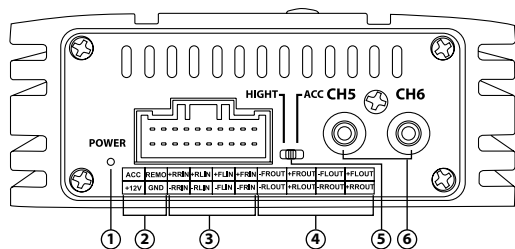

1. Power indicator light.
2. Power input.
3. 4-channel high level input.
4. 4-channel speaker output.
5. Selector switch between Hi-Input selection or ACC powered selection for amplifier wake up triggering.
6. 2-channel low level RCA output.

SPECIFICATION

Audio

- RMS Power : 43W x 4(4Ω)
- DSP Resolution : 32 Bit
- Output Power RMS @ 4 Ohms ($\leq 1\%$ THD +N) : 43W/CH
- Distortion (THD) : $< 0.015\%$
- Damping Factor : > 70
- Operating Voltage : 10 -15V
- Sampling Rate : 48kHz
- Signal Converter A/D : Burr-Brown
- Signal Converter D/A : Burr-Brown

Output

- 2 x RCA/ Cinch
- 4 High Level Speaker Output
- Voltage RCA/ Cinch : 0.9V RMS

Input

- 4 High Level Speaker Input
- 1 x USB
- Impedence High Level : 1000 Ohms
- S/N Ratio Analog-in : 100dB

Feature

- 4 x 43W, Class D Amplifier
- Max. Output Power : 180W
- Frequency Response : 10Hz-20kHz
- Max. Current Consumption : 10A
- Dimension (W x H x D) : 153 x 112 x 45mm
- Weight : 0.92 kg

ADJUSTMENT RANGE

Equalizer adjustment

- Equalizer selector : On/Off
- Frequency range step : 1hz step (20hz – 20khz)
- Q value step : 0.1 step (0.1 – 10.0)
- Volume adjustment : 0.2 step (-24 – 11.7)

Crossover adjustment

- Crossover type selector : Link, Bessel, Butterworth
- Frequency adjustment : 1hz step (20Hz – 20Khz)
- Decibel Slope selector : 6 dB, 12 dB and 24 dB

Time Delay adjustment

- Delay unit cm : 0.72 step (0.72 – 159.3) centimetre
- Delay unit in ms : 0.21 step (0.21 – 4.604) millisecond

Channel adjustment

- Polarity phase selector: 0° and 180°
- Volume gain : 1.0 step (-60 – 0)
- Mute selector : On /Off

WIRING DIAGRAM

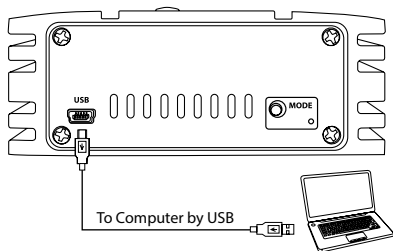

Car Specific Wiring Harness

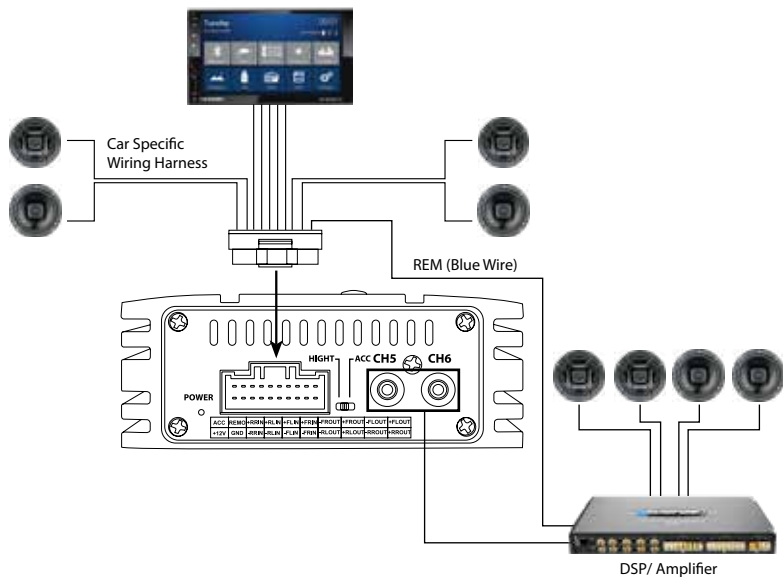

WIRING DIAGRAM

Universal Wiring Method

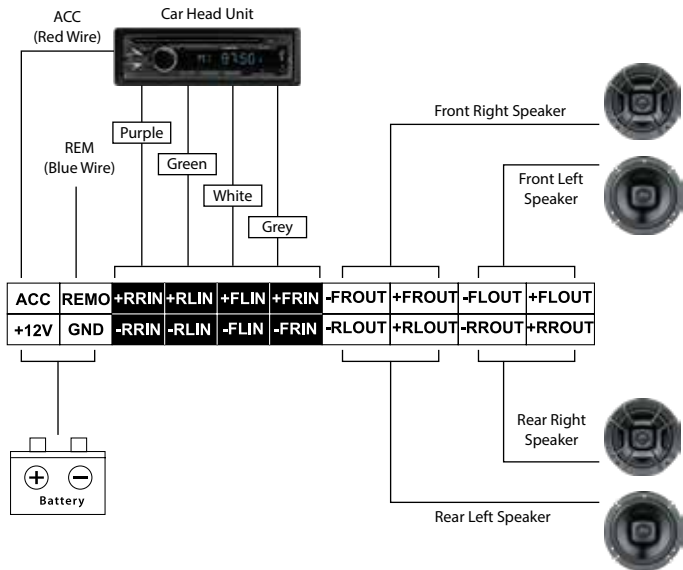

SOFTWARE OPERATION (WINDOWS)

Blaupunkt MPD 46 A Software

Visit www.blaupunkt.com/ase to download the software.

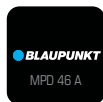

Blaupunkt.exe

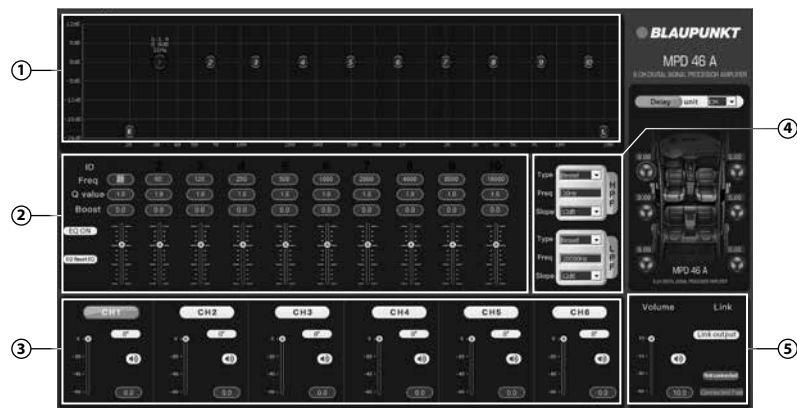

Channel panel (10-band Tuning)

1. 10-band tuning waveform

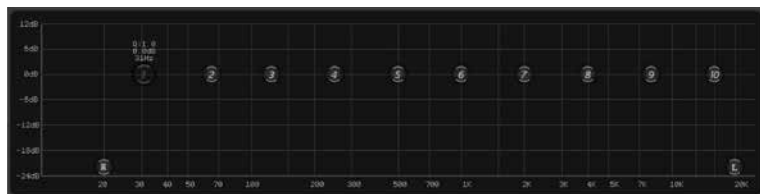

SOFTWARE OPERATION (WINDOWS)

2. 10-band equalizer control

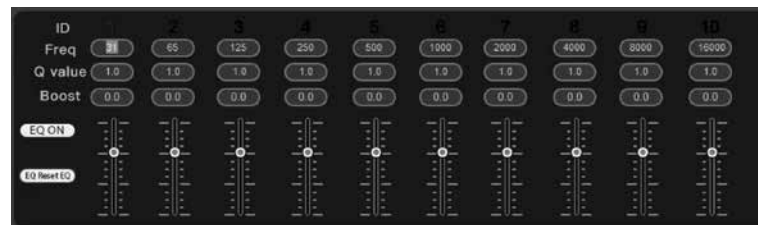

3. Channel Control



4. Crossover frequency setting :

- 3 Types of High-pass frequency
- 3 Types of Low-pass frequency



5. Main Volume Control

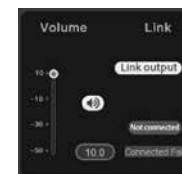



Free Manuals Download Website

<http://myh66.com>

<http://usermanuals.us>

<http://www.somanuals.com>

<http://www.4manuals.cc>

<http://www.manual-lib.com>

<http://www.404manual.com>

<http://www.luxmanual.com>

<http://aubethermostatmanual.com>

Golf course search by state

<http://golfingnear.com>

Email search by domain

<http://emailbydomain.com>

Auto manuals search

<http://auto.somanuals.com>

TV manuals search

<http://tv.somanuals.com>