

TOSHIBA
Carrier

FILE No. A10-1603
Revision 1 : Sep., 2016
Revision 2 : Jun., 2017

SERVICE MANUAL

AIR-CONDITIONER (MULTI TYPE)

<Outside Air Unit>

MMD-AP0481HF2UL

MMD-AP0721HF2UL

MMD-AP0961HF2UL

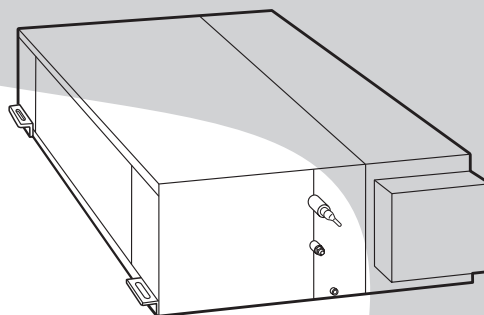



CONTENTS

SAFETY CAUTION	3
1. OUTLINE OF OUTSIDE AIR UNIT	8
1-1. SMMS System Specifications to Connect Outside Air Unit	9
2. SPECIFICATIONS	12
3. CONSTRUCTION VIEWS (EXTERNAL VIEWS).....	13
4. WIRING DIAGRAM	15
5. PARTS RATING	17
6. FAN CHARACTERISTIC.....	18
7. REFRIGERATING CYCLE DIAGRAM	22
8. CONTROL OUTLINE	23
9. APPLIED CONTROL AND FUNCTION	28
9-1. Indoor Print Circuit Board	28
9-2. Functions at test run	33
9-3. Method to Set Indoor Unit Function DN Code	35
9-4. Applied Control in Indoor Unit	38
10. TROUBLESHOOTING	51
10-1. Overview	51
10-2. Troubleshooting Method.....	52
10-3. Troubleshooting Based on Information Displayed on Remote Control	58
10-4. Check Codes Displayed on Remote Control and SHRM-e Outdoor Unit (7-Segment Display on I/F Board) and Locations to Be Checked	62
10-5. Sensor Characteristics	72
11. OWNER'S MANUAL	73
12. INSTALLATION MANUAL	82
13. DETACHMENTS	99
14. P.C. BOARD REPLACING PROCEDURES	104
15. EXPLODED VIEWS AND PARTS LIST	109

SAFETY CAUTION



The important contents concerned to the safety are described on the product itself and on this Service Manual. Please read this Service Manual and understand the described items thoroughly in the following contents (Indications/Illustrated marks), and keep the manual for reference. The manufacturer shall not assume any liability for the damage caused by not observing the description of this manual.

[Explanation of indications]

Indication	Explanation
 DANGER	Indicates that an imminent danger causing a death or serious injury of the repair engineers and the third parties may occur when an incorrect work has been executed.
 WARNING	Indicates possibilities of a danger causing death or serious injury of the repair engineers, the third parties, and the users due to problems from the product after installation when an incorrect work has been executed.
 CAUTION	Indicates that an injury or property damage (*) may be caused to the repair engineers, the third parties involved, and the users due to troubles of the product after installation when an incorrect work has been executed.

* Property damage : Enlarged damage concerned with property, furniture, and domestic animal/pet





[Explanation of illustrated marks]

Mark	Explanation
	Indicates prohibited items (Forbidden to do) The sentences near an illustrated mark describe the concrete prohibited contents.
	Indicates mandatory items (Compulsory to do) The sentences near an illustrated mark describe the concrete mandatory contents.
	Indicates cautions (Including danger/warning) The sentences or illustration near or in an illustrated mark describe the concrete cautious contents.









[Confirmation of warning label on the main unit]

Confirm that labels are indicated on the specified positions
(Refer to the Parts disassembly diagram (Outdoor unit).)







If removing the label when parts are being replaced, stick it back on the original location.

 DANGER	
 Turn off breaker.	Turn "OFF" the breaker before removing the front panel and cabinet, otherwise an electric shock is caused by high voltage which may result in death or injury. During operation, a high voltage with 400V or higher of circuit (*) at secondary circuit of the high-voltage transformer is applied. If touching a high voltage with the naked hands or body, an electric shock is caused even if using an electric insulator. * : For details, refer to the electric wiring diagram.
 Execute discharge between terminals.	When removing the front panel or cabinet, execute short-circuit and discharge between high-voltage capacitor terminals. If discharge is not executed, an electric shock is caused by high voltage which could result in death or injury. After turning off the breaker, high voltage is kept on the high-voltage capacitor.
 Prohibition	Do not turn on the breaker under condition that the front panel and cabinet are removed. An electric shock is caused by high voltage which could result in death or injury.



 **WARNING**

 Check ground wires.	<p>Before troubleshooting or repair work, check the ground wire is connected to the ground terminals of the main unit, otherwise an electric shock is caused when a leak occurs. If the ground wire is not correctly connected, contact an electrician for rework.</p>
 Prohibition of modification.	<p>Do not modify the products. Do not also disassemble or modify the parts. It may cause a fire, electric shock or injury.</p>
 Use specified parts.	<p>For spare parts, use those specified (*). If unspecified parts are used, a fire or electric shock may be caused. *: For details, refer to the parts list.</p>
 Do not bring a child close to the equipment.	<p>Before troubleshooting or repair work, do not bring a third party (a child, etc.) except the repair engineers close to the equipment. It causes an injury with tools or disassembled parts. Please inform the users so that the third party (a child, etc.) does not approach the equipment.</p>
 Insulating measures	<p>Connect the cut-off lead wires with crimp contact, etc, put the closed end side upward and then apply a water-cut method, otherwise a leak or fire is caused at the users' side.</p>
 No fire	<p>When repairing the refrigeration cycle, take the following measures.</p> <ol style="list-style-type: none"> 1) Be attentive to fire around the cycle. When using a gas stove, etc, be sure to put out fire before work; otherwise the oil mixed with refrigerant gas may catch fire. 2) Do not use a welder in the closed room. When using it without ventilation, carbon monoxide poisoning may be caused. 3) Do not bring inflammables close to the refrigerant cycle, otherwise fire of the welder may catch the inflammables.
 Refrigerant	<p>Check the used refrigerant name and use tools and materials of the parts which match with it. For the products which use R410A refrigerant, the refrigerant name is indicated at a position on the outdoor unit where is easy to see. To prevent miss-charging, the route of the service port is changed from one of the former R22.</p> <p>Do not use any refrigerant different from the one specified for complement or replacement. Otherwise, abnormally high pressure may be generated in the refrigeration cycle, which may result in a failure or explosion of the product or an injury to your body.</p> <p>For an air conditioner which uses R410A, never use other refrigerant than R410A. For an air conditioner which uses other refrigerant (R22, etc.), never use R410A. If different types of refrigerant are mixed, abnormal high pressure generates in the refrigeration cycle and an injury due to breakage may be caused.</p> <p>Do not charge additional refrigerant. If charging additional refrigerant when refrigerant gas leaks, the refrigerant composition in the refrigerating cycle changes results in change of air conditioner characteristics or refrigerant over the specified standard amount is charged and an abnormal high pressure is applied to the inside of the refrigerating cycle resulted in cause of breakage or injury. Therefore if the refrigerant gas leaks, recover the refrigerant in the air conditioner, execute vacuuming, and then newly recharge the specified amount of liquid refrigerant. In this time, never charge the refrigerant over the specified amount.</p> <p>When recharging the refrigerant in the refrigerating cycle, do not mix the refrigerant or air other than R410A into the specified refrigerant. If air or others is mixed with the refrigerant, abnormal high pressure generates in the refrigerating cycle resulted in cause of injury due to breakage.</p> <p>After installation work, check the refrigerant gas does not leak. If the refrigerant gas leaks in the room, poisonous gas generates when gas touches fire such as fan heater, stove or cooking stove though the refrigerant gas itself is innocuous.</p> <p>Never recover the refrigerant into the outdoor unit. When the equipment is moved or repaired, be sure to recover the refrigerant with recovering device. The refrigerant cannot be recovered in the outdoor unit; otherwise a serious accident such as breakage or injury is caused.</p>
 Assembly/Cabling	<p>After repair work, assemble the disassembled parts, and connect and lead the removed wires as before. Perform the work so that the cabinet or panel does not catch the inner wires. If incorrect assembly or incorrect wire connection was done, a disaster such as a leak or fire is caused at user's side.</p>

⚠ WARNING

 Insulator check	<p>After the work has finished, be sure to use an insulation tester set (500V Megger) to check the resistance is 2MΩ or more between the charge section and the non-charge metal section (Ground position).</p> <p>If the resistance value is low, a disaster such as a leak or electric shock is caused at user's side.</p>
 Ventilation	<p>When the refrigerant gas leaks during work, execute ventilation.</p> <p>If the refrigerant gas touches a fire, poisonous gas generates. A case of leakage of the refrigerant and the closed room full with gas is dangerous because a shortage of oxygen occurs. Be sure to execute ventilation.</p>
 Be attentive to electric shock	<p>When checking the circuit with the power-ON, use rubber gloves and do not touch the charging section.</p> <p>If touching to the charging section, an electric shock may be caused.</p> <p>When you access inside of the service panel to repair electric parts, wait for about five minutes after turning off the breaker. Do not start repairing immediately. Otherwise you may get electric shock by touching terminals of high-voltage capacitors. Natural discharge of the capacitor takes about five minutes.</p>
 Compulsion	<p>When the refrigerant gas leaks, find the leaked position and repair it.</p> <p>If the leaked position cannot be found and the repair work is interrupted, pump-down and tighten the service valve, otherwise the refrigerant gas may leak into the room. The poisonous gas generates when gas touches fire such as fan heater, stove or cooking stove though the refrigerant gas itself is innocuous.</p> <p>When installing equipment which includes a large amount of charged refrigerant such as a multi air conditioner in a sub-room, it is necessary that the density does not the limit even if the refrigerant leaks.</p> <p>If the refrigerant leaks and exceeds the limit density, an accident of shortage of oxygen is caused.</p> <p>For the installation/moving/reinstallation work, follow to the Installation Manual.</p> <p>If an incorrect installation is done, a trouble on the refrigerating cycle, water leak, electric shock or fire is caused.</p>
 Check after repair	<p>After repair work has been finished, check there is no trouble.</p> <p>If check is not executed, a fire, electric shock or injury may be caused. For a check, turn off the power breaker.</p>
 Check after reinstallation	<p>After repair work (installation of front panel and cabinet) has finished, execute a test run to check there is no generation of smoke or abnormal sound.</p> <p>If check is not executed, a fire or an electric shock is caused. Before test run, install the front panel and cabinet.</p> <p>Check the following items after reinstallation.</p> <ol style="list-style-type: none"> 1) The ground wire is correctly connected. 2) The power cord is not caught in the product. 3) There is no inclination or unsteadiness and the installation is stable.

⚠ CAUTION

 Put on gloves	<p>Be sure to put on the gloves (*) and a long sleeved shirt: otherwise an injury may be caused with the parts, etc.</p> <p>(*) Heavy gloves such as work gloves</p>
 Cooling check	<p>When the power is turned on, start to work after the equipment has been sufficiently cooled.</p> <p>As temperature of the compressor pipes and others became high due to cooling/heating operation, a burn may be caused.</p>

• Refrigerant (R410A)

This air conditioner adopts a HFC type refrigerant (R410A) which does not deplete the ozone layer.

1. Safety Caution Concerned to Refrigerant (R410A)

The pressure of R410A is high 1.6 times of that of the previous refrigerant (R22).

Accompanied with change of refrigerant, the refrigerating oil has been also changed.

Therefore, be sure that water, dust, the previous refrigerant or the previous refrigerating oil is not mixed into the refrigerating cycle of the air conditioner with refrigerant (R410A) installation work or service work.

If an incorrect work or incorrect service is performed, there is a possibility of a serious accident.

Use the tools and materials exclusive to R410A to ensure a safe work.

2. Cautions on Installation/Service

1) Do not mix other refrigerant or refrigerating oil.

For the tools exclusive to R410A, shapes of all the joints including the service port differ from those of the previous refrigerant in order to prevent mixture of them.

2) As the use pressure of the refrigerant (R410A) is high, use material thickness of the pipe and tools which are specified for R410A.

3) In the installation time, use clean pipe materials and work with great attention so that water and others do not mix in because pipes are affected by impurities such as water, oxide scales, oil, etc.

Use clean pipes.

Be sure to braze with flowing nitrogen gas. (Never use any other gas except for nitrogen.)

4) For the ground protection, use a vacuum pump for air purge.

5) R410A refrigerant is azeotropic mixture type refrigerant.

Therefore use liquid type to charge the refrigerant. (If using gas for charging, composition of the refrigerant changes and then characteristics of the air conditioner change.)

3. Pipe Materials

For the refrigerant pipes, copper pipe and joints are mainly used.

It is necessary to select the most appropriate pipes to conform to the standard.

Use clean material in which impurities adhere inside of pipe or joint is minimal.

1) Copper pipe

<Piping>

The pipe thickness, flare finishing size, flare nut and others differ according to a refrigerant type.

When using a long copper pipe for R410A, it is recommended to select "Copper or copper-base pipe without seam" and one with bonded oil amount 0.0001 lbs / 32' 10" (40mg / 10m) or less.

Also do not use crushed, deformed, discolored (especially inside) pipes.

(Impurities cause clogging of expansion valves and capillary tubes.)

<Flare nut>

Use the flare nuts which are attached to the air conditioner unit.

2) Joint

The flare joint and socket joint are used for joints of the copper pipe.

The joints are rarely used for installation of the air conditioner. However clear impurities when using them.

4. Tools

1. Required Tools for R410A

Mixing of different types of oil may cause a trouble such as generation of sludge, clogging of capillary, etc. Accordingly, the tools to be used are classified into the following three types.

- 1) Tools exclusive for R410A (Those which cannot be used for conventional refrigerant (R22))
- 2) Tools exclusive for R410A, but can be also used for conventional refrigerant (R22)
- 3) Tools commonly used for R410A and for conventional refrigerant (R22)

The table below shows the tools exclusive for R410A and their interchangeability.

Tools exclusive for R410A (The following tools for R410A are required.)

Tools whose specifications are changed for R410A and their interchangeability

No.	Used tool	Usage	R410A air conditioner installation		Conventional air conditioner installation
			Existence of new equipment for R410A	Whether conventional equipment can be used	Whether conventional equipment can be used
①	Flare tool	Pipe flaring	Yes	*(Note)	Yes
②	Copper pipe gauge for adjusting projection margin	Flaring by conventional flare tool	Yes	*(Note)	*(Note)
③	Torque wrench	Tightening of flare nut	Yes	No	No
④	Gauge manifold	Evacuating, refrigerant charge, run check, etc.	Yes	No	No
⑤	Charge hose				
⑥	Vacuum pump adapter	Vacuum evacuating	Yes	No	Yes
⑦	Electronic balance for refrigerant charging	Refrigerant charge	Yes	Yes	Yes
⑧	Refrigerant cylinder	Refrigerant charge	Yes	No	No
⑨	Leakage detector	Gas leakage check	Yes	No	Yes

(Note) When flaring is carried out for R410A using the conventional flare tools, adjustment of projection margin is necessary. For this adjustment, a copper pipe gauge, etc. are necessary.

General tools (Conventional tools can be used.)

In addition to the above exclusive tools, the following equipments which serve also for R22 are necessary as the general tools.

- | | |
|---|--|
| 1) Vacuum pump. Use vacuum pump by attaching vacuum pump adapter. | 7) Screwdriver (+, -) |
| 2) Torque wrench | 8) Spanner or Monkey wrench |
| 3) Pipe cutter | 9) Hole core drill |
| 4) Reamer | 10) Hexagon wrench (Opposite side 4mm) |
| 5) Pipe bender | 11) Tape measure |
| 6) Level vial | 12) Metal saw |

Also prepare the following equipments for other installation method and run check.

- | | |
|----------------|--|
| 1) Clamp meter | 3) Insulation resistance tester (Megger) |
| 2) Thermometer | 4) Electroscop |

1. OUTLINE OF OUTSIDE AIR UNIT

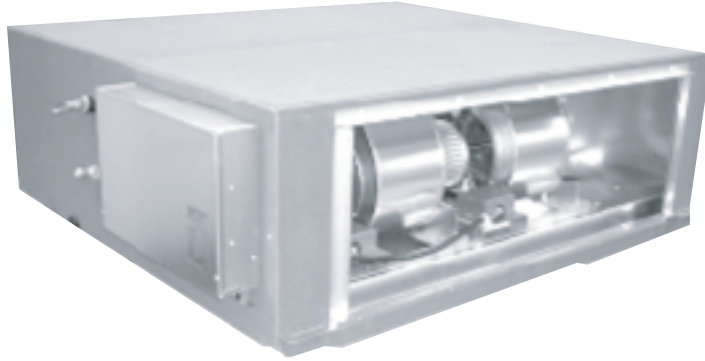

- **Type: Concealed Duct High Static Pressure type**

Three models 4 ton, 6 ton and 8 ton are prepared.

- **Connectable outdoor unit**

SMMS-i series (MMY-MAP***4HT6UL, MMY-MAP***4HT9UL), SMMS-e series (MMY-MAP***6HT6P-UL, MMY-MAP***6HT9P-UL) of Heat pump super modular multi type outdoor unit.

- **Corresponding system**

SMMS-i can connect to MMD-AP0481HF2UL for using diversity 30% (cooling basis) or below.

■ Definition

The Outside Air Unit means an air control for taken-in outside air.

Intake of the outside air often influences on the system so that the normal control of the air conditioner becomes difficult or gives a large load upon air control and cooling performance.

Therefore it is frequently adopted to handle the outside air to a certain condition before the outside air will enter in the main air conditioner.

This handling device is called a Outside Air Unit.

NOTE:

The Outside Air Unit is an air conditioner provided to handle the outside air load and is not to control the room temperature.

For correspondence to the load of the indoor air control, set an air conditioner separately.

1-1. SMMS System Specifications to Connect Outside Air Unit

1-1-1. Combination conditions

- The Outside Air Unit is connectable to SMMS-i and SMMS-e.
- However this is not connectable to SHRM-i and SHRM-e.
- The total capacity of the indoor units and the Outside Air Units is restricted to 80% to 100% against the capacity of the outdoor units. (This restriction should be strictly kept for correct control of the refrigerant.)
- Up to two Outside Air Units can be connected on one line of the multi system. The allowable total capacity of the two Outside Air Units shall be 30% or less against the total capacity of the indoor units (including the Outside Air Unit).

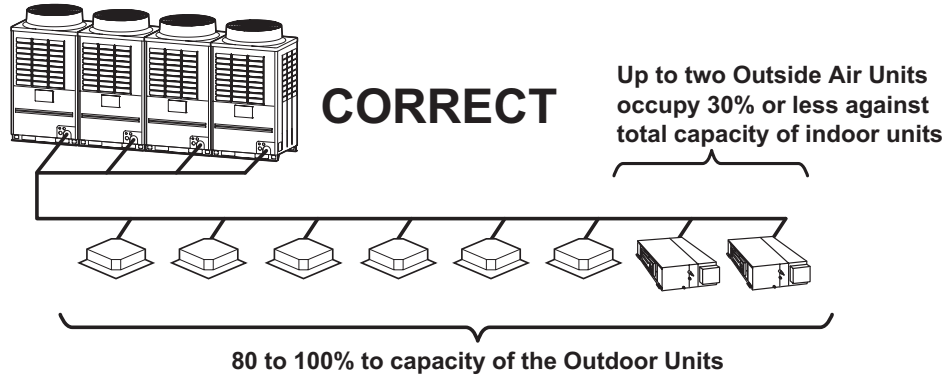

- The Outside Air Unit is usually used together with the indoor units on one line of the multi system. The Outside Air Unit only cannot be connected.

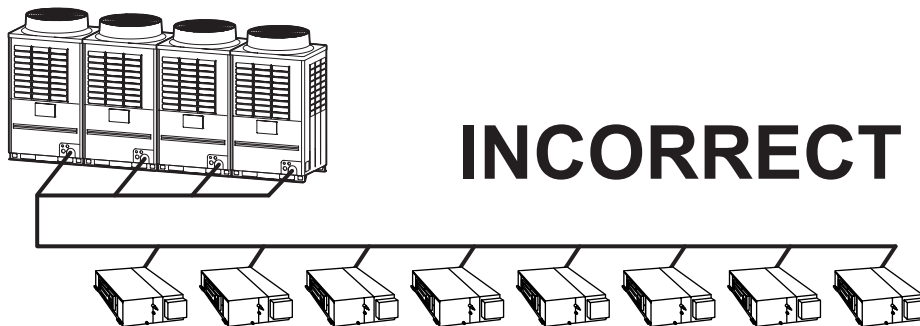

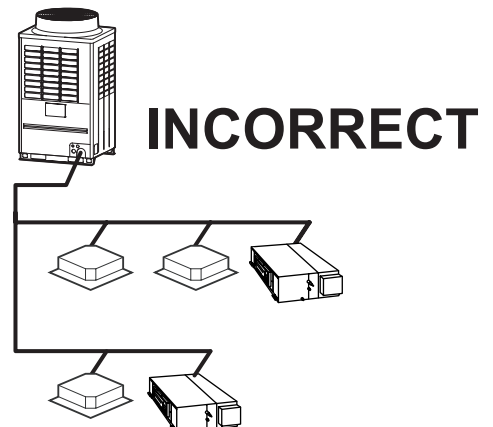
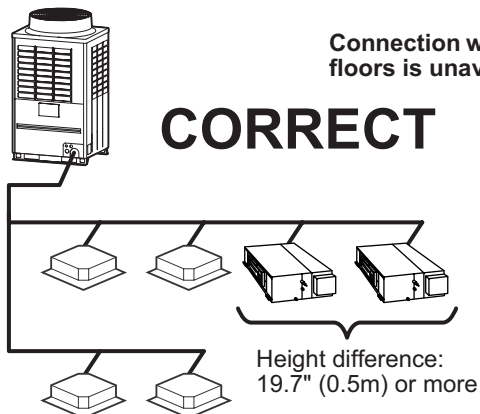

- Keep the height difference between the Outside Air Units to 19.7" (0.5m) or less.



1-1-2. Use conditions

■ Changing the set temperature

1 Push the “TEMP. ” buttons of the wired remote control.

Push  to increase the temperature, and to  decrease the temperature. (The set temperature cannot be changed in the fan mode.)

Operation mode	Setting range	Factory default
COOL	61 to 80 °F	64 °F
HEAT		77 °F

NOTE

When heating

The air conditioner may continue running in the fan mode for about 30 seconds after stopping heating.

■ Operation mode and function

COOL : Cools the outside air and sends it into the room

HEAT : Heats the outside air and sends it into the room

FAN : Sends the outside air as it is

The air conditioner with the Outside Air Unit controls temperature of the supply air so that it is close to the setup temperature of the remote control.

However temperature of the supply air may not be close to the setup temperature according to temperature of the outside air or the operation condition of the indoor units for air conditioning in one line.

REQUIREMENT

- The air conditioner with the Outside Air Unit cannot control the room temperature.
- For control of the room temperature, an indoor unit for air conditioning is required separately.

■ Use conditions

- In COOL mode, if temperature of the outside air is under the setup temp. +5.4 °F, FAN status is automatically made. When temperature of the outside air is under 66 °F, FAN status is also made regardless of the setup temperature.
- In HEAT mode, if temperature of the outside air is over the setup temp. -5.4 °F, FAN status is automatically made. When temperature of the outside air is over 59 °F, FAN status is also made regardless of the setup temperature.

• Case to use in SMMS-i

Outdoor Air Temperature °F

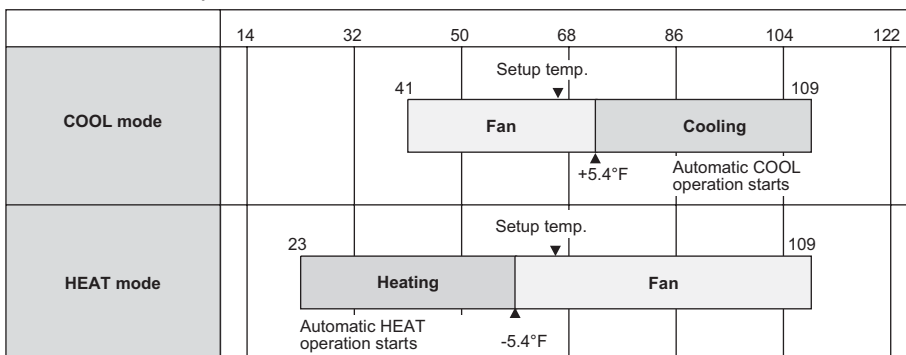

• **Case to use in SMMS-e**

Outdoor Air Temperature °F

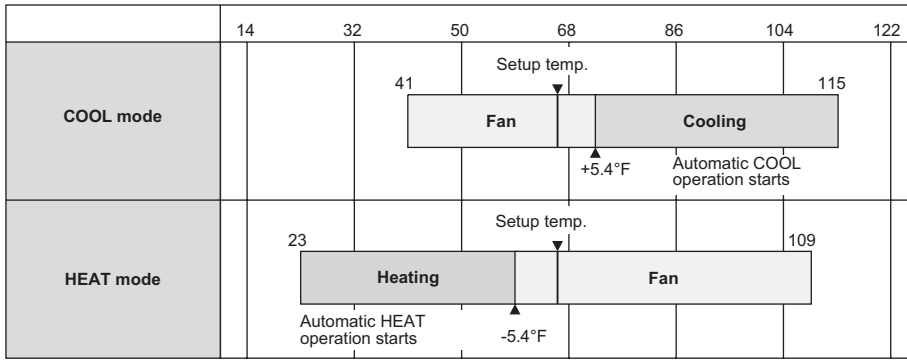

REQUIREMENT

- In “COOL” or “FAN” mode, if temperature of the outside air is under 41 °F, the operation stop automatically in order to protect the equipment.
In this case, continue the operation by selecting “HEAT” mode.
- In “HEAT” mode, if temperature of the outside air is under 23 °F, the operation stops automatically in order to protect the equipment.
When operating the air conditioner with the outside air temp. under 23 °F (minimum 5 °F), set temp. of the outside air to be taken in to 23 °F or upper using a duct heater (locally procured).
For details, consult the dealer which you purchased the air conditioner.

2. SPACIFICATIONS

Outside Air Unit

Model name		MMD-	AP0481HF2UL	AP0721HF2UL	AP0961HF2UL
Cooling capacity	(Note1)	kBtu/h	48.0	72.0	96.0
Heating capacity	(Note1)	kBtu/h	30.0	47.0	59.0
Electical characteristics	Power supply		230V (208/230V) 1phase		
	Running current	A	1.58/1.56	3.00/2.88	3.32/3.17
	Power consumption	kW	0.31/0.34	0.56/0.58	0.64/0.66
	Starting current	A	3.90/3.20	7.70/6.30	8.50/6.90
Outer dimension	Height	In	19.5"		
	Width	In	35.4"	55"	
	Depth	In	49.8"		
Main unit weight		lbs	212	349	
Heat exchanger			Finned tube		
Soundproof / Heat-insulationg material			Non-flammable insulation		
Fan			Centrifugal fan		
Standard air flow		cfm	636	989	1237
Motor		W	160	160x2	
External static pressure (factory default)	208V/230V	In WG	0.55/0.86	0.74/1.00	0.41/0.85
External static pressure	208V(H / M / L)	In WG	0.75/0.55/0.16	0.84/0.74/0.24	0.67/0.41 (H/L)
	230V(H / M / L)	In WG	1.06/0.86/0.50	1.08/1.00/0.65	1.01/0.85 (H/L)
Air flow limit	Lower limit	cfm	445	693	866
	Upper limit	cfm	700	1088	1360
Air filter			Field supply		
Control			Wired remote control		
Connecting pipe	Gas pipe	In	5/8"	7/8"	
	Liquid pipe	In	3/8"	1/2"	
	Drain pipe	In	VP25 (Polyvinyl chloride tube : External Dia.1-1/4 internal Dia.1)		
Sound pressure level	208V(H / M / L)	dB(A)	44/43/36	47/46/40	47/45 (H/L)
	230V(H / M / L)	dB(A)	46/45/42	48/47/46	50/49 (H/L)
Operation range for SMMS-i	Cooling (Note 2)	°F	41 - 109		
	Heating (Note 3)	°F	23 - 109		
Operation range for SMMS-e	Cooling (Note 2)	°F	41 - 115		
	Heating (Note 3)	°F	23 - 109		

* The setting temperature is 60 - 80 °F.

* Height difference between Outside Air Units must be within 1.97"(0.5 m).

Note 1: Rated conditions Cooling : Outdoor air temperature 91 °F DB/82 °F WB setting temperature 64 °F
 Heating : Outdoor air temperature 32 °F DB/26 °F WB setting temperature 77 °F

Note 2: * When supply air temperature is "setting temperature + 5.4 °F" or less, Outside Air Unit operates as FAN mode.

Note 3: * When supply air temperature is "setting temperature - 5.4 °F" or over, Outside Air Unit operates as FAN mode.

3. CONSTRUCTION VIEWS (EXTERNAL VIEWS)

3-1. MMD-AP0481HF2UL

Unit : in (mm)

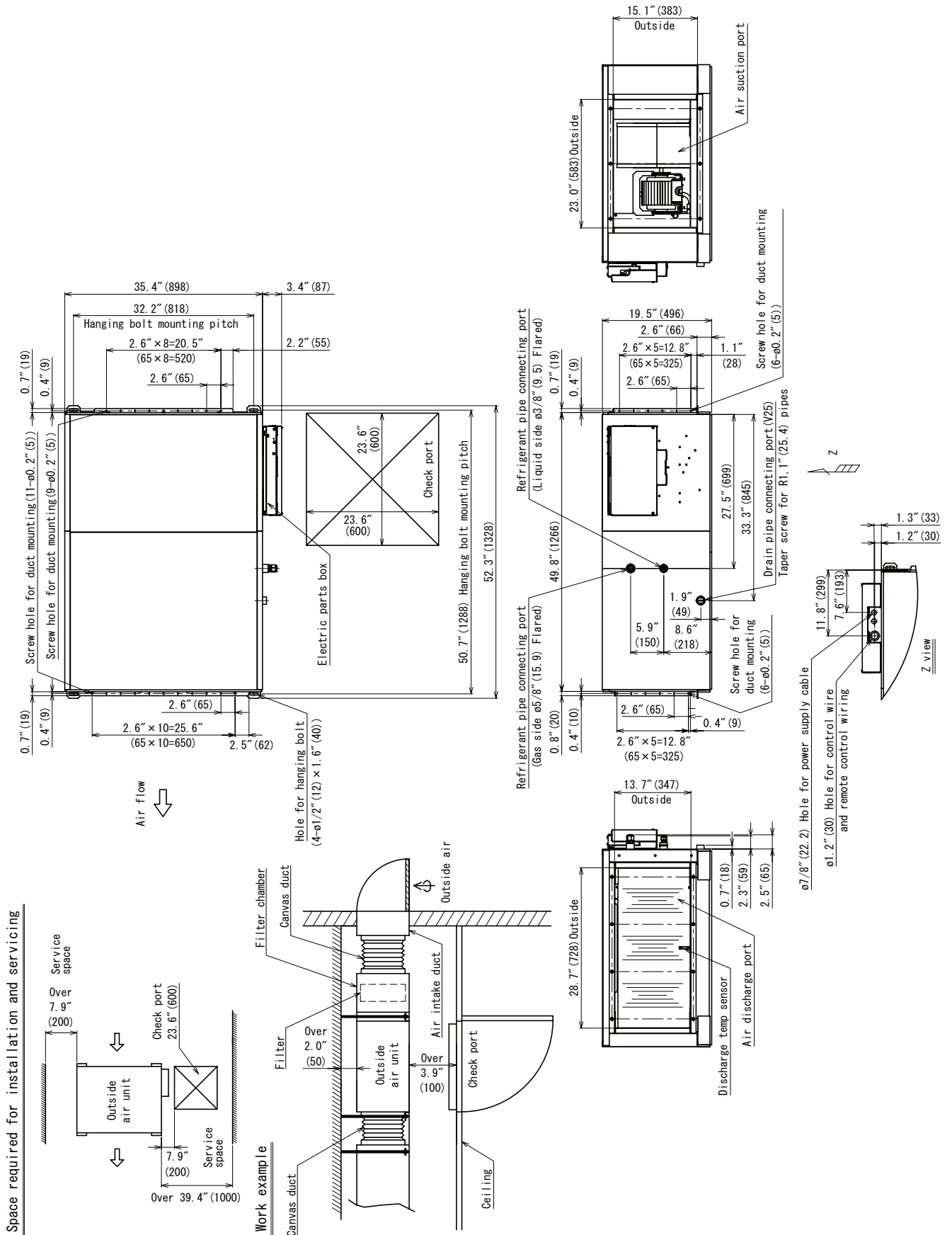

4. WIRING DIAGRAM

4-1. MMD-AP0481HF2UL

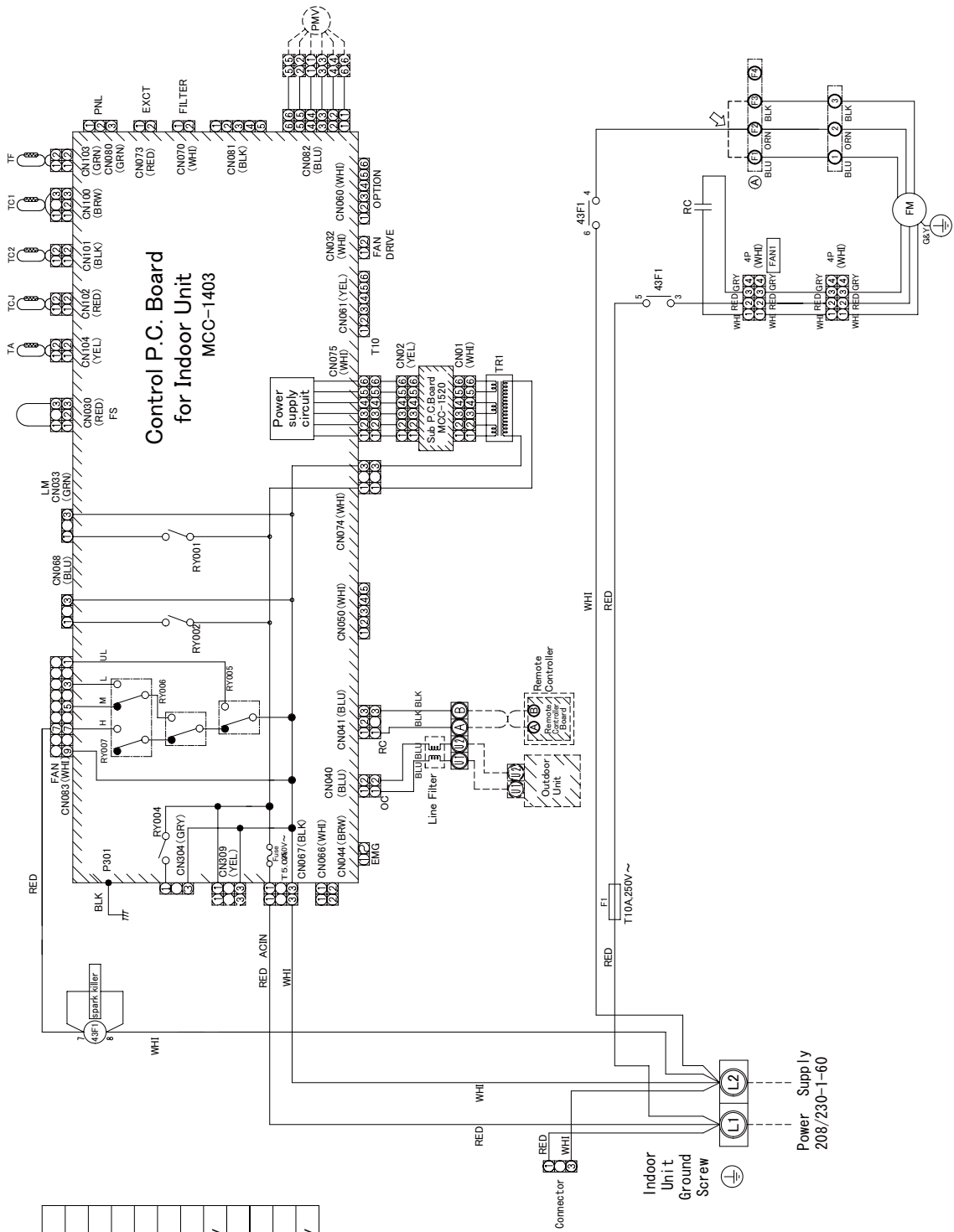

Symbol	Parts Name
FM	Fan Motor
RC	Running Capacitor
TR1	Transformer
TA	Intake air temp. sensor
TF	Blow temp. sensor
TC1, TC2, TCJ	Temp sensor
RY005~007	Fan Motor Control Relay
RY002	Drain Control Relay
PMV	Pulse Motor Valve
F1	Fuse for Fan Motor
43F1	Fan Motor Control Relay

COLOR IDENTIFICATION
RED: RED
WHI: WHITE
YEL: YELLOW
BLU: BLUE
BLK: BLACK
GRY: GRAY
PNK: PINK
ORN: ORANGE
BRW: BROWN
G&Y: GREEN&YELLOW

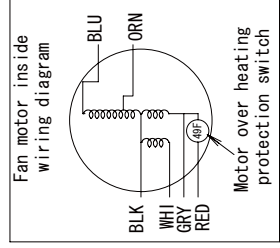

1. Ⓞ indicates the terminal block.
Letter at inside indicates the terminal number.
2. A dotted line and broken line indicate the wiring at site.
3. [Symbol] indicates the control P.C board.
4. ⓐ position is connected to terminal block when change to static pressure.
exchange the lead wire of arrow (L2) position after check the terminal number as figure and lead wire's color of fan motor.

4-2. MMD-AP0721HF2UL, AP0961HF2UL

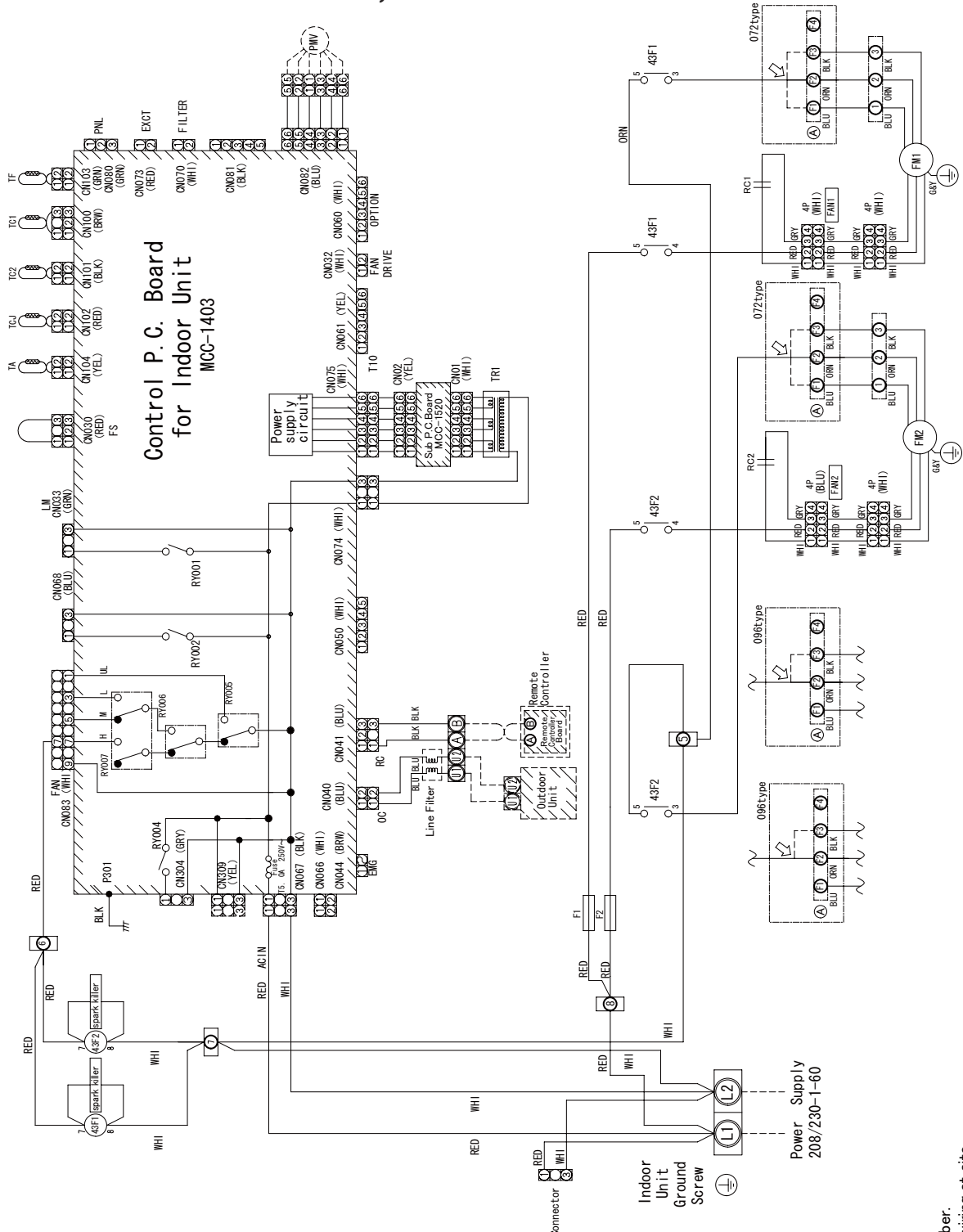

Symbol	Parts Name
FM	Fan Motor
RC	Running Capacitor
TR1	Transformer
TA	Intake air temp. sensor
TF	Blow temp. sensor
TC1, TC2, TCJ	Temp sensor
RY005~007	Fan Motor Control Relay
RY002	Drain Control Relay
PMV	Pulse Motor Valve
F1	Fuse for Fan Motor
43F1	Fan Motor Control Relay

COLOR IDENTIFICATION
RED: RED
WHI: WHITE
YEL: YELLOW
BLU: BLUE
BLK: BLACK
GRY: GRAY
PNK: PINK
ORN: ORANGE
BRW: BROWN
G&Y: GREEN & YELLOW

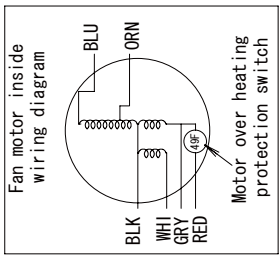

1. (C) indicates the terminal block.
Letter at inside indicates the terminal number.
2. A dotted line and broken line indicate the wiring at site.
3. (Z) indicates the control P.C board.
4. (A) position is connected to terminal block when change to static pressure.
exchange the lead wire of arrow (Z) position after check the terminal number as figure and lead wire's color of fan motor.

5. PARTS RATING

Parts name	MMD-AP0481HF2UL	MMD-AP0721HF2UL, MMD-AP0961HF2UL
Fan motor	STF200-160U4A	
Running capacitor for fan motor	400V 6 μ F	400V 4 μ F
Transformer	TT-12	
TA sensor	Lead wire length: 47.2 in (1200mm)	Lead wire length: 32.2 in (818mm)
TF sensor	Lead wire length: 98.4 in (2500mm)	
TC1 sensor	\varnothing 0.16 in (\varnothing 4 mm) size, Lead wire length: 47.2 in (1200mm), Vinyl tube (Blue)	\varnothing 0.16 in (\varnothing 4 mm) size, Lead wire length: 78.7 in (2000mm), Vinyl tube (Blue)
TC2 sensor	\varnothing 0.24 in (\varnothing 6 mm) size, Lead wire length: 47.2 in (1200mm), Vinyl tube (Black)	\varnothing 0.24 in (\varnothing 6 mm) size, Lead wire length: 78.7 in (2000mm), Vinyl tube (Black)
TCJ sensor	\varnothing 0.24 in (\varnothing 6 mm) size, Lead wire length: 47.2 in (1200mm), Vinyl tube (Red)	\varnothing 0.24 in (\varnothing 6 mm) size, Lead wire length: 78.7 in (2000mm), Vinyl tube (Red)
Pulse motor	EDM-MD12TF-3	
Electronic control valve	EDM-B60YGTF-1	EDM-BAOYGTF-1

6. FAN CHARACTERISTIC

<MMD-AP0481HF2UL>

Power source: 230 V / 60 Hz

Tap	External static pressure (in WG)	Standard air flow rate (cfm)
High	1.06	636
Middle	0.86	
Low	0.50	

Power source: 208 V / 60 Hz

Tap	External static pressure (in WG)	Standard air flow rate (cfm)
High	0.75	636
Middle	0.55	
Low	0.16	

230V cfm - A

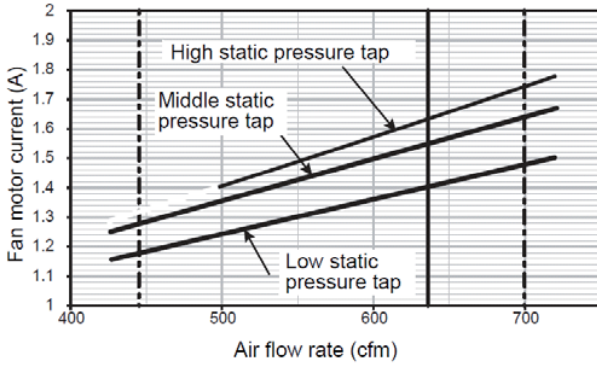

230V cfm - A

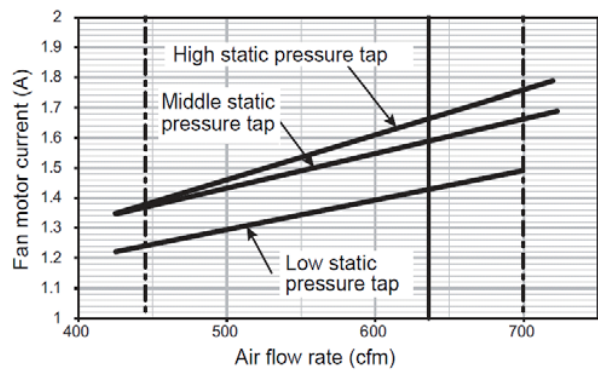

230V Fan characteristics

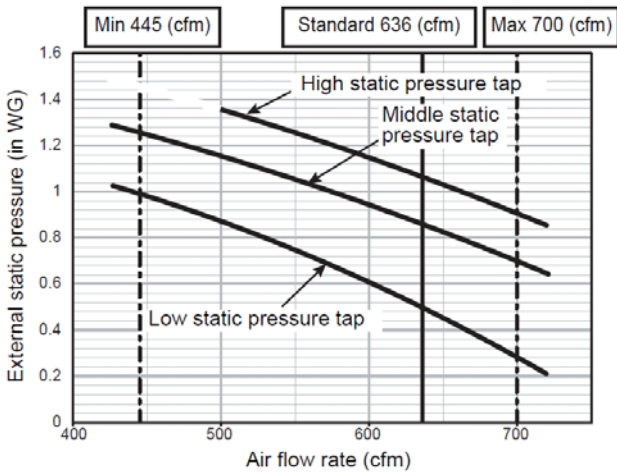

230V Fan characteristics

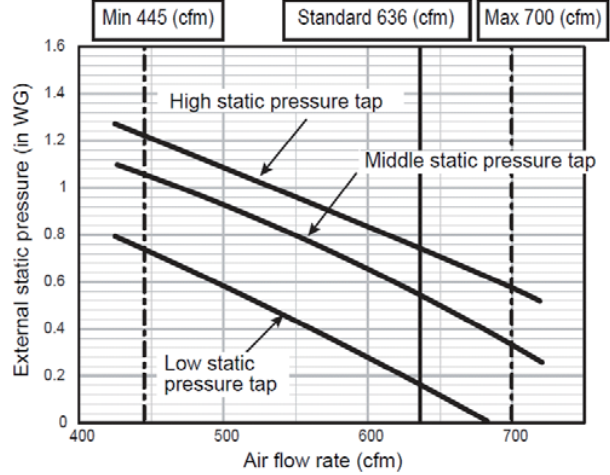

<MMD-AP0721HF2UL>

Power source: 230 V / 60 Hz

tap	External static pressure (in WG)	Standard air flow rate (cfm)
High	1.08	989
Middle	1.00	
Low	0.65	

230V cfm - A

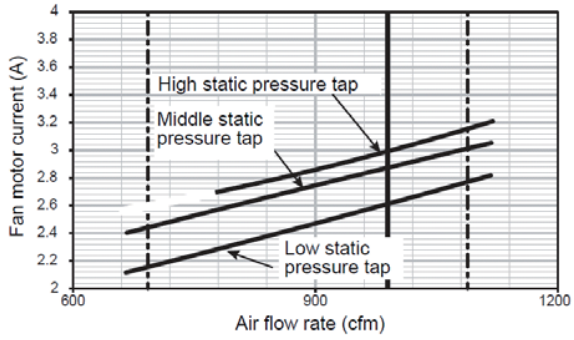

Power source: 208 V / 60 Hz

tap	External static pressure (in WG)	Standard air flow rate (cfm)
High	0.84	989
Middle	0.74	
Low	0.24	

230V cfm - A

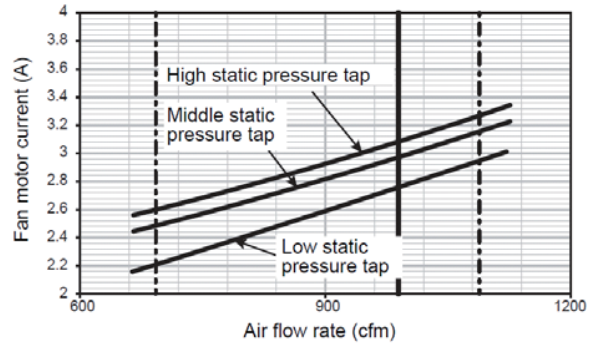

230V Fan characteristics

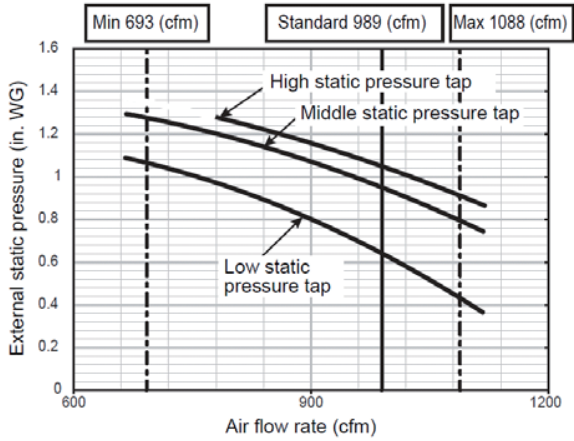

230V Fan characteristics

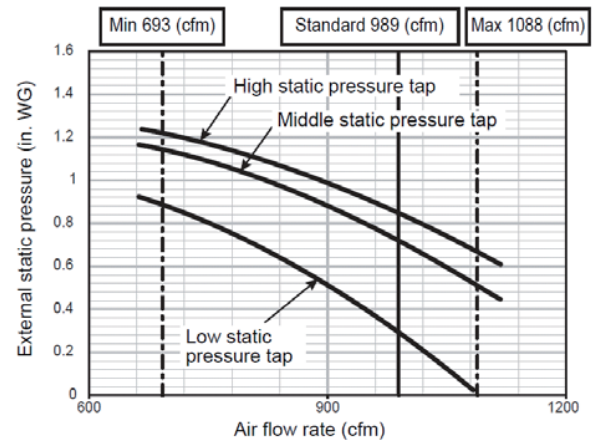

<MMD-AP0961HF2UL>

Power source: 230 V / 60 Hz

tap	External static pressure (in WG)	Standard air flow rate (cfm)
High	1.01	1237
Low	0.85	

230V cfm - A

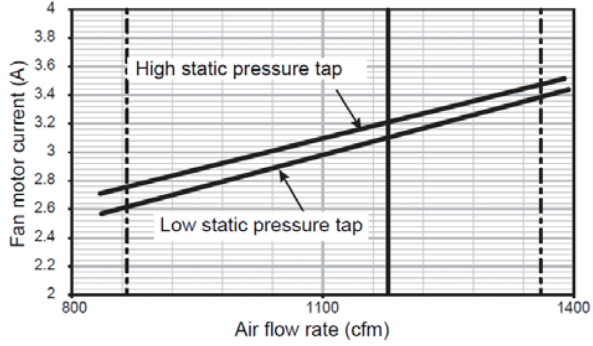

230V Fan characteristics

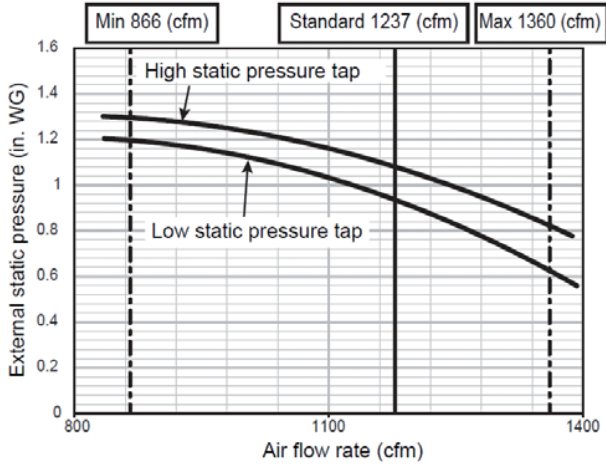

Power source: 208 V / 60 Hz

tap	External static pressure (in WG)	Standard air flow rate (cfm)
High	0.67	1237
Low	0.41	

230V cfm - A

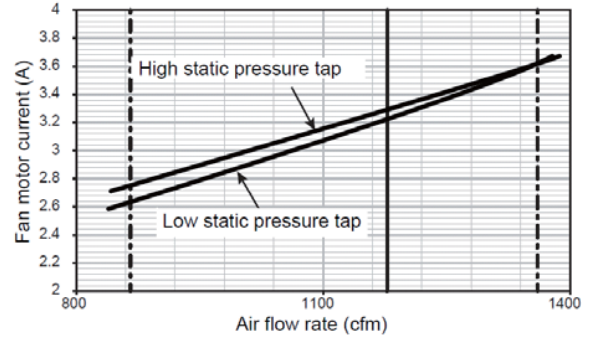

230V Fan characteristics

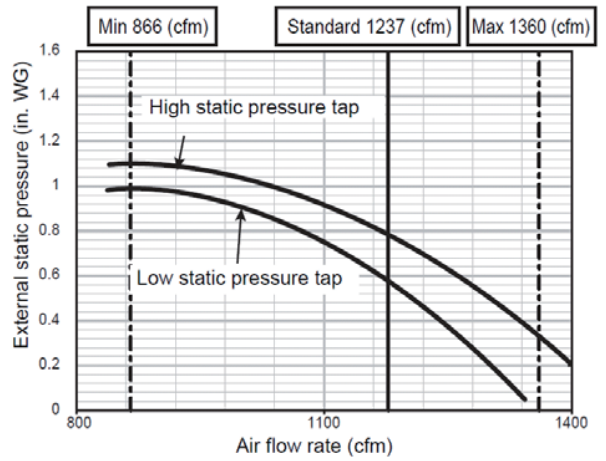

■ Wire connection change of fan motor

The motor wires for the fan have been connected to (F2) at shipment from the factory. Change the wire connection if change of the external static pressure is required due to the duct resistance.

<MMD-AP048 type>

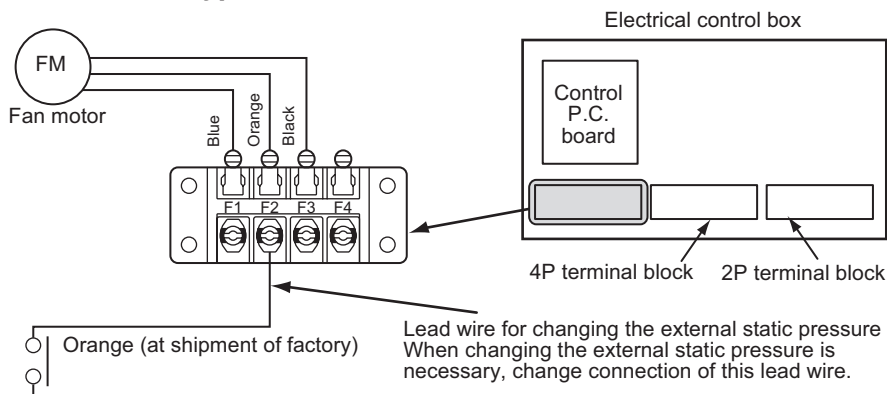

<MMD-AP072 type, AP096 type>

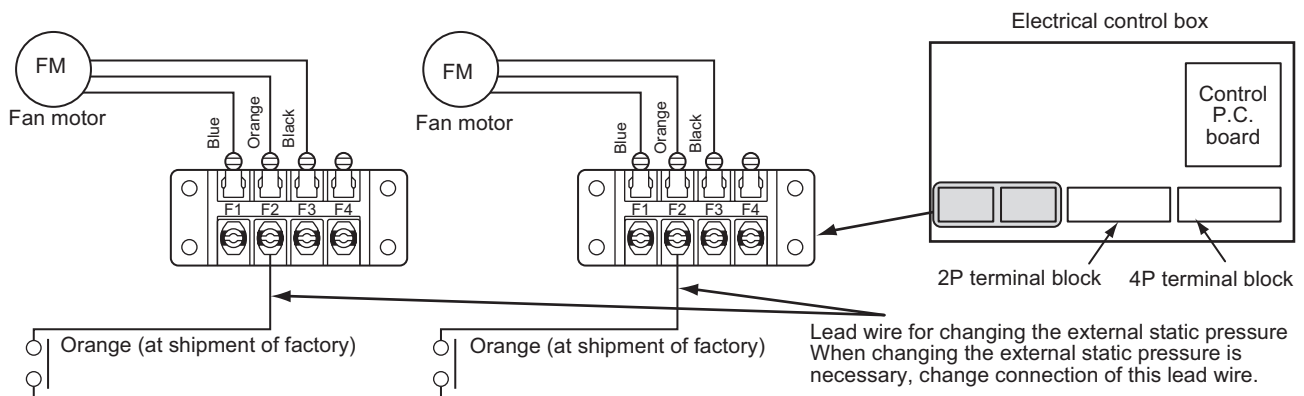

REQUIREMENT

When the external static pressure was changed, enter the changed static pressure value in the identification plate of the unit.

<MMD-AP048, AP072 type>

Terminal block No.	Fan motor wiring	Remarks
F1 (Low static pressure tap)	Blue	—
F2 (Middle static pressure tap)	Orange	At shipment from factory
F3 (High static pressure tap)	Black	—

<MMD-AP096 type>

Terminal block No.	Fan motor wiring	Remarks
F1 (-)	Blue	Not used.
F2 (Low static pressure tap)	Orange	At shipment from factory
F3 (High static pressure tap)	Black	—

7. REFRIGERATING CYCLE DIAGRAM

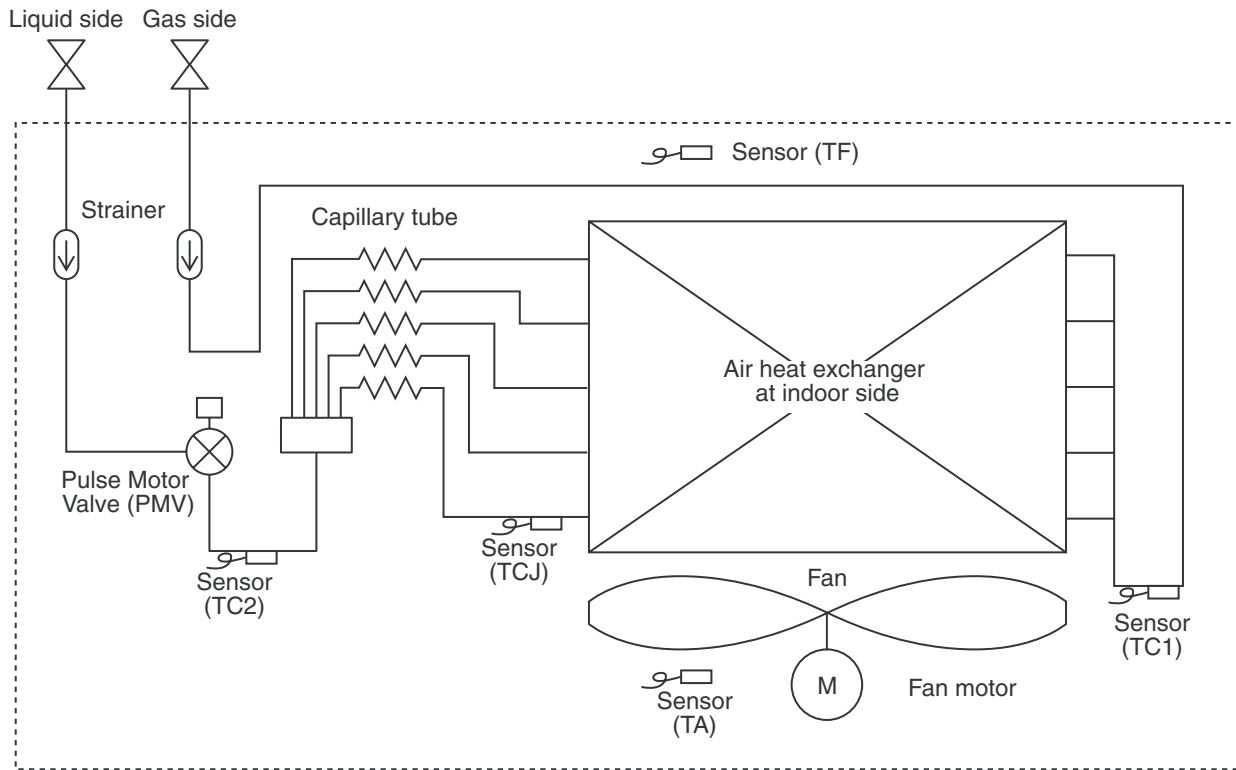

Functional part name		Function outline
Pulse motor valve	PMV	(Connector CN082 (6P): Blue) 1) Super heat control function in cooling operation 2) Subcool control function in heating operation 3) Cooling refrigerant oil recovery function 4) Heating refrigerant oil recovery function
Temperature sensor	1. TA	(Connector CN104 (2P): Yellow) 1) For detection of outdoor suction temperature
	2. TC1	(Connector CN100 (3P): Brown) 1) For super heat control of PMV in cooling operation
	3. TC2	(Connector CN101 (2P): Black) 1) For subcool control of PMV in heating operation
	4. TCJ	(Connector CN102 (2P): Red) 1) For super heat control of PMV in cooling operation
	5. TF	(Connector CN103 (2P): Green) 1) For detection of discharge temperature

8. CONTROL OUTLINE

No.	Item	Outline of specifications	Remarks										
1	When power supply is reset	<p>1) Distinction of outdoor units When the power supply is reset, the outdoor units are distinguished, and control is selected according to the distinguished result.</p> <p>2) If resetting the power during a problem, the check code is cleared. After ON/OFF button on the remote control is pushed to resume operation and the problem persists, the check code is again displayed on the remote control.</p>											
2	Operation selection	<p>1) The operation mode is selected based on the operation mode command on the remote control.</p> <table border="1" data-bbox="443 748 1070 981"> <thead> <tr> <th>Command from remote control</th> <th>Control outline</th> </tr> </thead> <tbody> <tr> <td>STOP</td> <td>Outside Air Unit stops.</td> </tr> <tr> <td>FAN</td> <td>Fan operation</td> </tr> <tr> <td>COOL</td> <td>Cooling operation</td> </tr> <tr> <td>HEAT</td> <td>Heating operation</td> </tr> </tbody> </table> <p>* DRY or AUTO mode cannot be selected.</p>	Command from remote control	Control outline	STOP	Outside Air Unit stops.	FAN	Fan operation	COOL	Cooling operation	HEAT	Heating operation	
Command from remote control	Control outline												
STOP	Outside Air Unit stops.												
FAN	Fan operation												
COOL	Cooling operation												
HEAT	Heating operation												
3	Remote control setup temperature	<p>1) Adjustment range</p> <p>① Adjustment range</p> <ul style="list-style-type: none"> In cooling or heating operation: 61 to 81 °F [16 to 27 °C] <p>② At shipment from factory:</p> <ul style="list-style-type: none"> In cooling operation: 64 °F [18 °C] In heating operation: 77 °F [25 °C] 											
4	Capacity control	<p>1) Differed from other indoor air conditioners, the Outside Air Unit usually operates with the maximum capacity.</p>											
5	PMV control	<p>1) Outside Air Unit controls PMV using the corrected value of each sensor according to the operation mode.</p> <p>① COOL</p> <ul style="list-style-type: none"> SH control is performed by correcting indoor coil temp (TC1) and inlet air temp. from outside (TA). <p>② HEAT</p> <ul style="list-style-type: none"> UC control is performed by correcting indoor coil temp (TC2, TCJ) and inlet air temp. from outside (TA). <p>2) The value displayed by monitor function of the remote control switch becomes the corrected sensor data. (See Monitor function of the remote control switch.)</p>	Data to be corrected: Inlet air temp. from outside (TA), Indoor coil temp (TCJ, TC2, TC1)										

No.	Item	Outline of specifications	Remarks																																																																																																				
6	Fan control	1) On the Outside Air Unit, HH tap only is provided. 2) For 1 minute after operation start, the forced fan OFF control is invalid. 3) There is no cool air discharge preventive control. 4) When refrigerant is recovered while cooling or fan operation is selected, and when cooling oil is recovered while heating operation is selected, the fan continues operation. However the priority is given to forced fan OFF control																																																																																																					
7	Forced thermostat OFF	1) The thermostat is forcedly off by outdoor suction temperature (TA). <ul style="list-style-type: none"> • COOL: At TA < 66 °F [19 °C] • HEAT: At TA > 59 °F [15 °C] or TA < 23 °F [- 5 °C] 2) The thermostat is forcedly off by outdoor suction temperature (TA) and remote control setting temperature (TS). <ul style="list-style-type: none"> • COOL: At TA < TS + 5.4 °F [+ 3 °C] • HEAT: At TA > TS - 5.4 °F [- 3 °C] 																																																																																																					
8	Forced fan OFF	1) The thermostat is forcedly off by outdoor suction temperature (TA). <ul style="list-style-type: none"> • COOL/FAN: At TA < 41 °F [5 °C] • HEAT: At TA < 23 °F [- 5 °C] 2) After fan-OFF status continued for 60 minutes, turn on the fan for 1 minute. The forced fan-OFF status continues or released by outdoor suction temperature (TA) in this time. <Release conditions> <ul style="list-style-type: none"> • COOL/FAN: At TA ≥ 41 °F [5 °C] • HEAT: At TA ≥ 23 °F [- 5 °C] 3) Other forced fan OFF release conditions <ul style="list-style-type: none"> • Operation stop • Operation mode exchange • Test run mode Case to use in SMMS-i <table border="1" data-bbox="464 1559 1445 1778"> <thead> <tr> <th rowspan="2">Operation mode</th> <th colspan="9">Outside temp.</th> </tr> <tr> <th>[°C] °F</th> <th>[-10] 14</th> <th>[0] 32</th> <th>[10] 50</th> <th>[20] 68</th> <th>[30] 86</th> <th>[40] 104</th> <th>[50] 122</th> <th></th> </tr> </thead> <tbody> <tr> <td>COOL</td> <td></td> <td></td> <td>41 °F [5 °C]</td> <td colspan="3">TS + 5.4 °F [3 °C]</td> <td>109 °F [43 °C]</td> <td></td> <td></td> </tr> <tr> <td>HEAT</td> <td></td> <td>23 °F [-5 °C]</td> <td></td> <td colspan="3">TS - 5.4 °F [-3 °C]</td> <td></td> <td></td> <td></td> </tr> <tr> <td>FAN</td> <td></td> <td></td> <td></td> <td colspan="5">FAN</td> <td></td> <td></td> </tr> </tbody> </table> Case to use in SMMS-e <table border="1" data-bbox="464 1827 1445 2047"> <thead> <tr> <th rowspan="2">Operation mode</th> <th colspan="9">Outside temp.</th> </tr> <tr> <th>[°C] °F</th> <th>[-10] 14</th> <th>[0] 32</th> <th>[10] 50</th> <th>[20] 68</th> <th>[30] 86</th> <th>[40] 104</th> <th>[50] 122</th> <th></th> </tr> </thead> <tbody> <tr> <td>COOL</td> <td></td> <td></td> <td>41 °F [5 °C]</td> <td colspan="3">TS + 5.4 °F [3 °C]</td> <td>115 °F [46 °C]</td> <td></td> <td></td> </tr> <tr> <td>HEAT</td> <td></td> <td>23 °F [-5 °C]</td> <td></td> <td colspan="3">TS - 5.4 °F [-3 °C]</td> <td>109 °F [43 °C]</td> <td></td> <td></td> </tr> <tr> <td>FAN</td> <td></td> <td></td> <td></td> <td colspan="5">FAN</td> <td></td> <td></td> </tr> </tbody> </table>	Operation mode	Outside temp.									[°C] °F	[-10] 14	[0] 32	[10] 50	[20] 68	[30] 86	[40] 104	[50] 122		COOL			41 °F [5 °C]	TS + 5.4 °F [3 °C]			109 °F [43 °C]			HEAT		23 °F [-5 °C]		TS - 5.4 °F [-3 °C]						FAN				FAN							Operation mode	Outside temp.									[°C] °F	[-10] 14	[0] 32	[10] 50	[20] 68	[30] 86	[40] 104	[50] 122		COOL			41 °F [5 °C]	TS + 5.4 °F [3 °C]			115 °F [46 °C]			HEAT		23 °F [-5 °C]		TS - 5.4 °F [-3 °C]			109 °F [43 °C]			FAN				FAN							Operation ready display
Operation mode	Outside temp.																																																																																																						
	[°C] °F	[-10] 14	[0] 32	[10] 50	[20] 68	[30] 86	[40] 104	[50] 122																																																																																															
COOL			41 °F [5 °C]	TS + 5.4 °F [3 °C]			109 °F [43 °C]																																																																																																
HEAT		23 °F [-5 °C]		TS - 5.4 °F [-3 °C]																																																																																																			
FAN				FAN																																																																																																			
Operation mode	Outside temp.																																																																																																						
	[°C] °F	[-10] 14	[0] 32	[10] 50	[20] 68	[30] 86	[40] 104	[50] 122																																																																																															
COOL			41 °F [5 °C]	TS + 5.4 °F [3 °C]			115 °F [46 °C]																																																																																																
HEAT		23 °F [-5 °C]		TS - 5.4 °F [-3 °C]			109 °F [43 °C]																																																																																																
FAN				FAN																																																																																																			

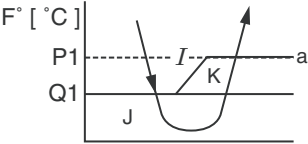
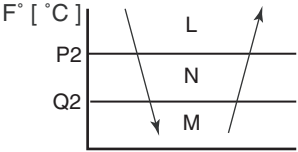
No.	Item	Outline of specifications	Remarks															
9	Freeze preventive control (Low temperature release)	<p>1) The cooling operation is performed as follows based on the detected temperature of TC1 sensor, TC2 sensor and TCJ sensor.</p> <ul style="list-style-type: none"> • When [J] zone is detected for 5 minutes, thermostat is forced to turn off. • In [K] zone, timer counting pauses and is held. • When [J] zone is detected, timer is cleared and returns to normal operation. • If thermostat is forcedly off by continuation of [J] zone, indoor fan only operates until zone changes to [I] zone. <p>When the following conditions are satisfied, control function resets.</p> <p><Reset conditions></p> <ol style="list-style-type: none"> ① TC1 > 54 °F [12 °C] and TC2 > 54 °F [12 °C] and TCJ > 54 °F [12 °C] ② 20 minutes passed after stop  <table border="1" data-bbox="466 992 1078 1115"> <thead> <tr> <th></th> <th>TC1</th> <th>TC2, TCJ</th> </tr> </thead> <tbody> <tr> <td>P1</td> <td>50 °F [10 °C] (41 °F [5 °C])</td> <td>14 °F [-10 °C]</td> </tr> <tr> <td>Q1</td> <td>32 °F [0 °C]</td> <td>7 °F [-14 °C]</td> </tr> </tbody> </table> <p>() value: When power supply is turned on, if the value is under this temperature, thermostat is forcedly off.</p> <p>2) The cooling operation is performed as follows based on the detected temperature of TC2 sensor and TCJ sensor.</p> <p>When [M] zone is detected for 45 minutes, thermostat is forced to turn off.</p> <p>In [N] zone, timer counting pauses and is held.</p> <p>When shifting to [M] zone again, timer counting restarts and continues.</p> <p>When [L] zone is detected, timer is cleared and operation returns to normal operation.</p>  <table border="1" data-bbox="809 1641 1150 1765"> <thead> <tr> <th></th> <th>TC2, TCJ</th> </tr> </thead> <tbody> <tr> <td>P2</td> <td>41 °F [5 °C]</td> </tr> <tr> <td>Q2</td> <td>28 °F [-2 °C]</td> </tr> </tbody> </table> <p><Reset conditions></p> <ol style="list-style-type: none"> ① TC1 > 54 °F [12 °C] and TC2 > 54 °F [12 °C] and TCJ > 54 °F [12 °C] ② 20 minutes passed after stop 		TC1	TC2, TCJ	P1	50 °F [10 °C] (41 °F [5 °C])	14 °F [-10 °C]	Q1	32 °F [0 °C]	7 °F [-14 °C]		TC2, TCJ	P2	41 °F [5 °C]	Q2	28 °F [-2 °C]	
	TC1	TC2, TCJ																
P1	50 °F [10 °C] (41 °F [5 °C])	14 °F [-10 °C]																
Q1	32 °F [0 °C]	7 °F [-14 °C]																
	TC2, TCJ																	
P2	41 °F [5 °C]																	
Q2	28 °F [-2 °C]																	

No.	Item	Outline of specifications	Remarks
10	Cooling oil (Refrigerant) recovery control	<p>When the indoor air conditioner which stops, in which thermostat is off, or which operates [FAN] performs the following control by receiving the cooling oil (refrigerant) recovery signal from the outdoor unit.</p> <p>① Opens PMV of the indoor air conditioner with certain opening angle.</p>	<ul style="list-style-type: none"> • Recovery operation is usually performed every 2 hours.
11	Heating refrigerant (oil) recovery control	<p>When the indoor air conditioner which stops, in which thermostat is off, or which operates [FAN] performs the following control by receiving the heating refrigerant (oil) recovery signal from the outdoor unit.</p> <p>① Opens PMV of the indoor air conditioner with certain opening angle.</p> <p>② Detects temperature of TC2 and closes PMV.</p>	<ul style="list-style-type: none"> • Recovery operation is usually performed every 1 hour.
12	Short intermittent operation compensation control	<p>1) For 5 minutes after start of operation, the operation continues forcedly even if entering in thermostat OFF condition.</p> <p>(2) However cooling/heating selection, operation ready and protective control are given with priority, and thermostat is turned off.</p>	
13	Remained heat elimination	<p>1) If stopped from [HEAT] operation, the indoor fan operates for approx. 30 seconds.</p>	
14	Filter sign display	<p>1) Estimates operation time of the indoor fan, sends the filter exchange signal to remote control when the specified time (2500H) passed and then displays it on LCD.</p> <p>2) Clears the estimate timer when received filter reset signal from remote control. In this time, if the specified time has passed, resets the measured time and erases the LCD display.</p>	
15	[Operation stand-by] [Heating stand-by] display	<p><Ready stand-by>: displa displayed on the remote control.</p> <p>1) When the following check codes are indicated.</p> <ul style="list-style-type: none"> • There is an indoor air conditioner which detected indoor overflow [P10]. • There is an indoor air conditioner which detected interlock warning [L30]. <p>2) During forced thermo OFF.</p> <ul style="list-style-type: none"> • [COOL] operation is unavailable because other indoor air conditioner operates in [HEAT] mode. • COOL priority setting (Outdoor I/F P.C. board SW11-bit1 is ON) is made, and other indoor air conditioner operates in [COOL/DRY] mode. Therefore [HEAT] operation is unavailable. <p>3) When fan stops by forced fan OFF control.</p> <p>4) The above indoor air conditioners unavailable to operate enter in [Standby] status with thermo-OFF.</p> <p><HEAT stand-by>: displayed on the remote control.</p> <p>1) Defrosting</p> <ul style="list-style-type: none"> • Indoor fan stops because unit is under defrost operation. 	<ul style="list-style-type: none"> • [Operation stand-by] display • [Heating stand-by] display

No.	Item	Outline of specifications	Remarks																																																		
16	Central control mode selection	1) The remote control at indoor air conditioner side becomes able to select the operable contents of the unit by setup at the central control side. 2) Setup contents • In case of TCC-LINK central control	In central control mode, [Central control] display (Lights up) Display flashes when item which operation is prohibited was changed from remote control.																																																		
<table border="1"> <thead> <tr> <th data-bbox="231 501 437 600" rowspan="2">Operation from TCC-LINK central control</th> <th colspan="6" data-bbox="437 501 1262 539">Operation on RBC-ATM32UL</th> <th data-bbox="1262 501 1428 539" rowspan="2">RBC-AMT32UL</th> </tr> <tr> <th data-bbox="437 539 572 600">START/STOP setting</th> <th data-bbox="572 539 708 600">Operation selection</th> <th data-bbox="708 539 844 600">Timer setting</th> <th data-bbox="844 539 979 600">Temp setting</th> <th data-bbox="979 539 1117 600">Air speed setting</th> <th data-bbox="1117 539 1262 600">Air direction setting</th> </tr> </thead> <tbody> <tr> <td data-bbox="231 600 437 645">Single</td> <td data-bbox="437 600 572 645">○</td> <td data-bbox="572 600 708 645">○</td> <td data-bbox="708 600 844 645">○</td> <td data-bbox="844 600 979 645">○</td> <td data-bbox="979 600 1117 645">—</td> <td data-bbox="1117 600 1262 645">—</td> <td data-bbox="1262 600 1428 801" rowspan="5">[Central control] display</td> </tr> <tr> <td data-bbox="231 645 437 683">[Central 1]</td> <td data-bbox="437 645 572 683">×</td> <td data-bbox="572 645 708 683">○</td> <td data-bbox="708 645 844 683">×</td> <td data-bbox="844 645 979 683">○</td> <td data-bbox="979 645 1117 683">—</td> <td data-bbox="1117 645 1262 683">—</td> </tr> <tr> <td data-bbox="231 683 437 721">[Central 2]</td> <td data-bbox="437 683 572 721">×</td> <td data-bbox="572 683 708 721">×</td> <td data-bbox="708 683 844 721">×</td> <td data-bbox="844 683 979 721">×</td> <td data-bbox="979 683 1117 721">—</td> <td data-bbox="1117 683 1262 721">—</td> </tr> <tr> <td data-bbox="231 721 437 759">[Central 3]</td> <td data-bbox="437 721 572 759">○</td> <td data-bbox="572 721 708 759">×</td> <td data-bbox="708 721 844 759">○</td> <td data-bbox="844 721 979 759">×</td> <td data-bbox="979 721 1117 759">—</td> <td data-bbox="1117 721 1262 759">—</td> </tr> <tr> <td data-bbox="231 759 437 801">[Central 4]</td> <td data-bbox="437 759 572 801">○</td> <td data-bbox="572 759 708 801">×</td> <td data-bbox="708 759 844 801">○</td> <td data-bbox="844 759 979 801">○</td> <td data-bbox="979 759 1117 801">—</td> <td data-bbox="1117 759 1262 801">—</td> </tr> </tbody> </table>				Operation from TCC-LINK central control	Operation on RBC-ATM32UL						RBC-AMT32UL	START/STOP setting	Operation selection	Timer setting	Temp setting	Air speed setting	Air direction setting	Single	○	○	○	○	—	—	[Central control] display	[Central 1]	×	○	×	○	—	—	[Central 2]	×	×	×	×	—	—	[Central 3]	○	×	○	×	—	—	[Central 4]	○	×	○	○	—	—
Operation from TCC-LINK central control	Operation on RBC-ATM32UL						RBC-AMT32UL																																														
	START/STOP setting	Operation selection	Timer setting	Temp setting	Air speed setting	Air direction setting																																															
Single	○	○	○	○	—	—	[Central control] display																																														
[Central 1]	×	○	×	○	—	—																																															
[Central 2]	×	×	×	×	—	—																																															
[Central 3]	○	×	○	×	—	—																																															
[Central 4]	○	×	○	○	—	—																																															
(○ : Operation available, × : Operation unavailable)																																																					
* For the Outside Air Unit, setting functions for air speed and air direction are not provided.																																																					

9. APPLIED CONTROL AND FUNCTION

9-1. Indoor Control Block Diagram

9-1-1. When Main (Simple) Wired Remote Control Connected

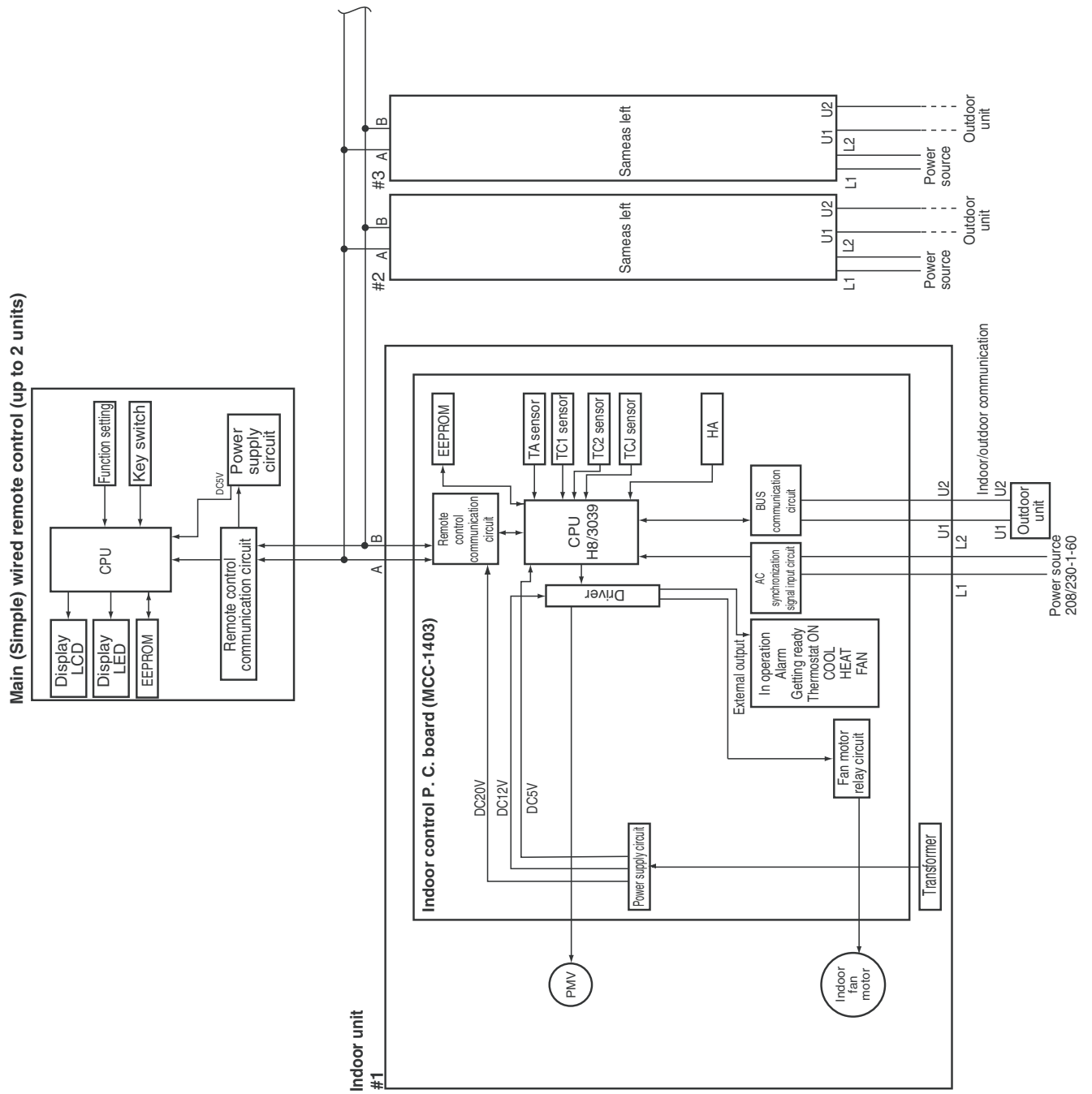

9-1-2. When Wireless Remote Control Kit Connected

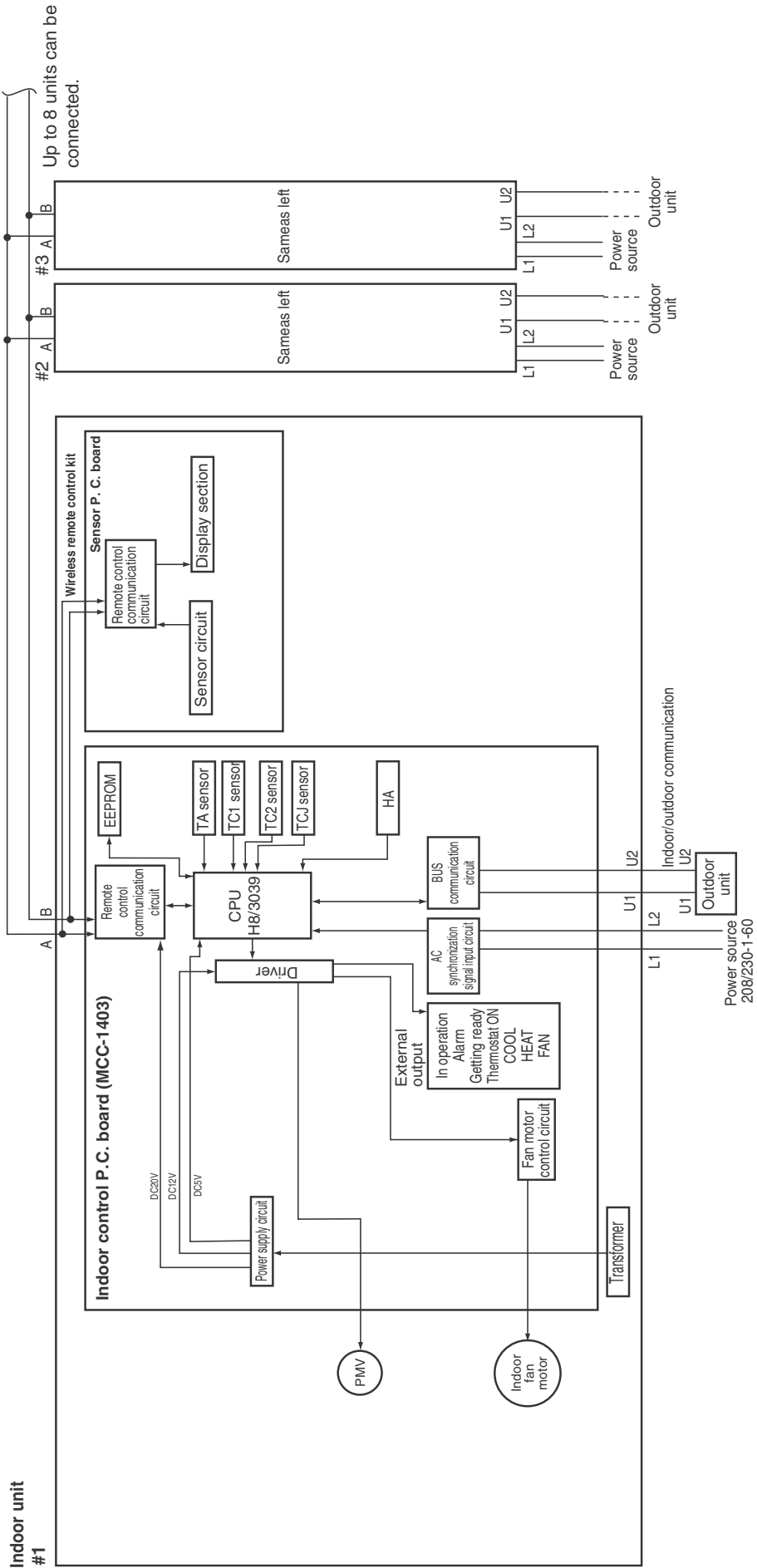

9-1-3. When Both Wired (Simple) Remote Control and Wireless Remote Control Kit Connected

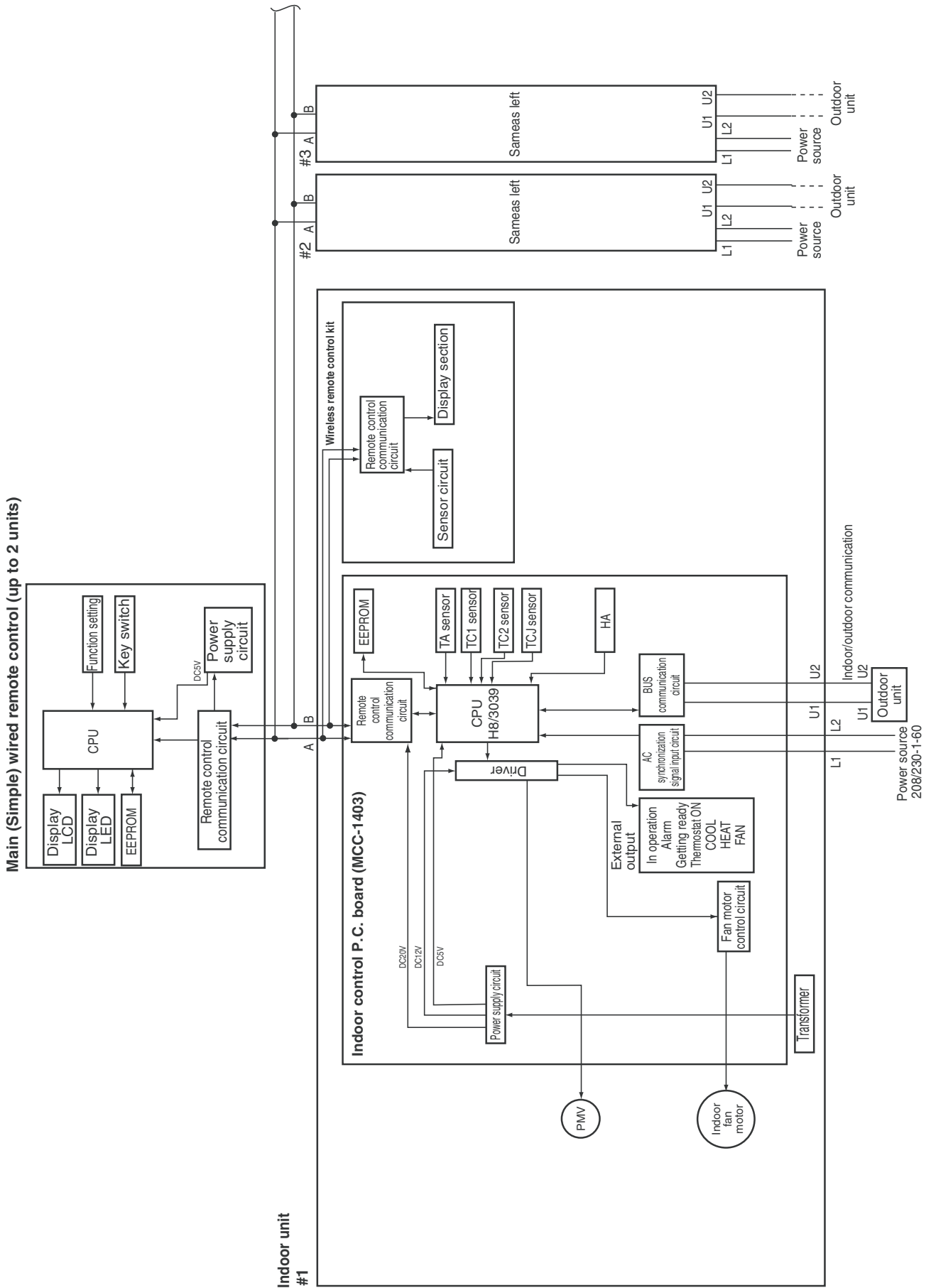

9-1-4. Indoor Printed Circuit Board

MCC-1403

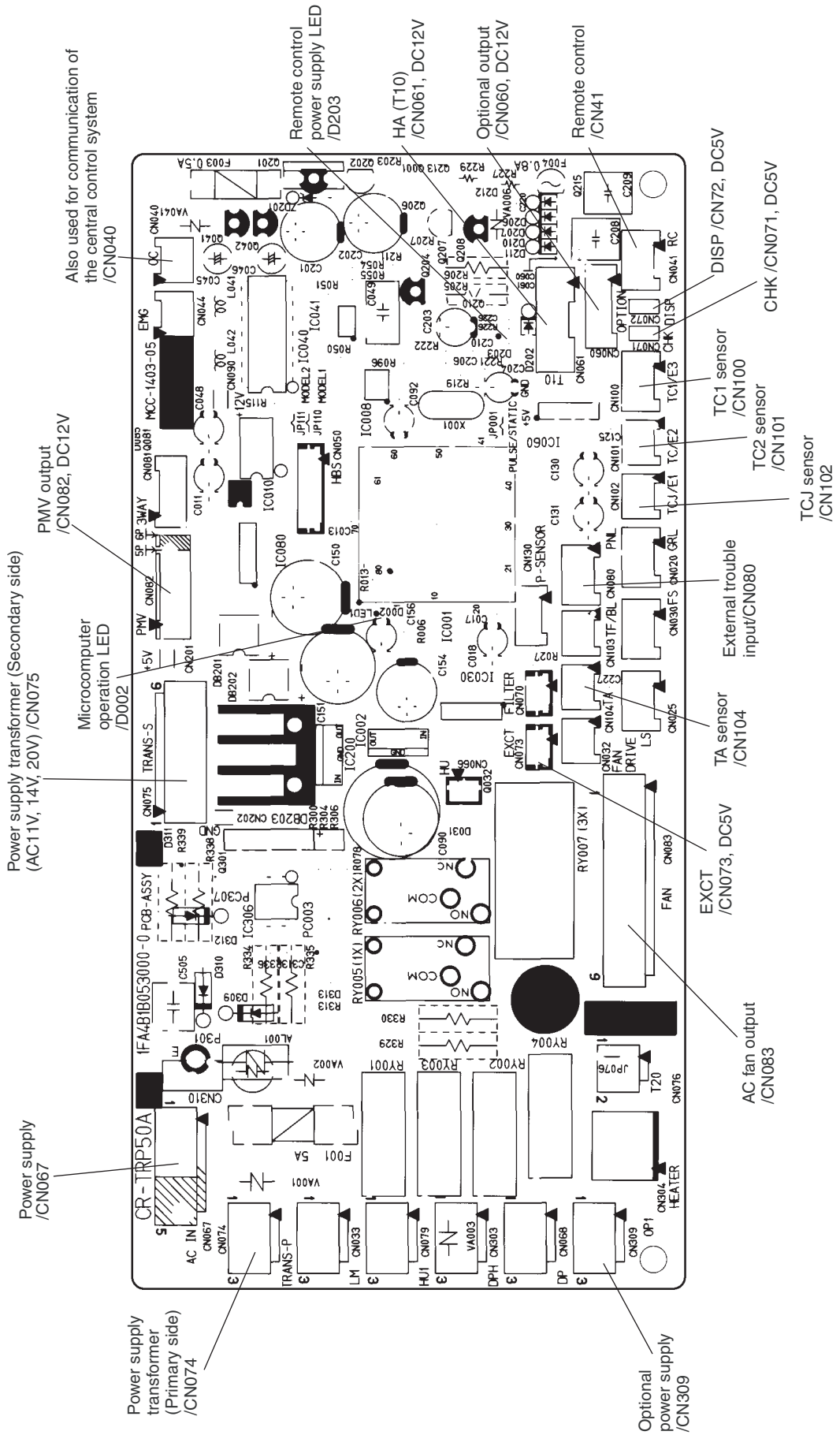

9-1-5. P.C. Board Optional Switch/Connector Specifications

Function	Connector No.	Pin No.	Specifications	Remarks
Ventilation output	CN032	①	DC12V	Setting at shipment: Linked operation; ON with indoor air conditioner operation, OFF with stop * Single operation setting by [VENT] button of remote control is performed from remote control. (DN=31)
		②	Output	
HA	CN061	①	Start/Stop input	HA Start/Stop input (J01: Provided/None= Pulse (At shipment from factory) / Static input selection)
		②	0V (COM)	
		③	Remote control disabling input	Enables / disables start / stop control via remote control
		④	Operation output	ON during operation (Answer back of HA)
		⑤	DC12V (COM)	
		⑥	Alarm output	ON during output of alarm
Option output	CN060	①	DC12V (COM)	
		②	Defrost output	ON during defrosting of outdoor unit
		③	Thermo-ON output	ON during real thermo-ON (Compressor ON)
		④	Cooling output	ON when operation mode is COOL
		⑤	Heating output	ON when operation mode is HEAT
		⑥	Fan output	ON when indoor fan is on (When purifier is used / Interlock wiring)
Outside abnormal input	CN080	①	DC12V (COM)	The check code "L30" is generated continuously for 1 minute and the operation stops forcedly.
		②	DC12V (COM)	
		③	Outside abnormal input	
Filter option trouble	CN070	①	Outside setting input	Setting of humidifier provided / none (Short plug attached at shipment from factory)
		②	0V	
CHK operation check	CN071	①	Check mode input	This function is used to check indoor operation. (The specified operation such as indoor fan "ON" is output without communication with outdoor or remote control.)
		②	0V	
DISP display mode	CN072	①	Display mode input	This function enables the display mode to communicate with indoor air conditioner and remote control only. (When power supply is turned on) Timer short (Usually)
		②	0V	
EXCT demand	CN073	①	Demand input	Forced thermo-OFF operation of indoor air conditioner.
		②	0V	

9-2. Functions at test run

■ Cooling/Heating test run check

The test run for cooling/heating can be performed from either indoor remote control or outdoor interface P.C. board.

1. Start/Finish operation of test run

◎ Test run from indoor remote control

└ Wired remote control: Refer to the below item of "Test run" of the wired remote control.

◆ In case of wired remote control

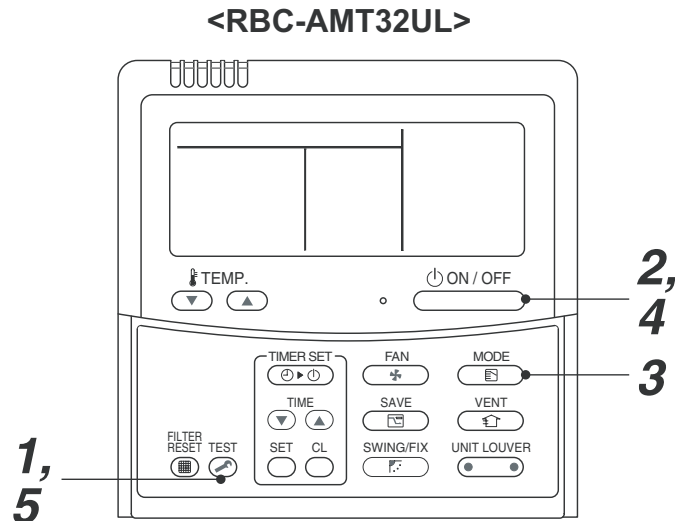

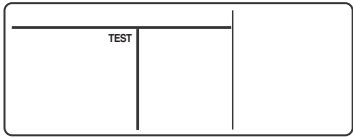
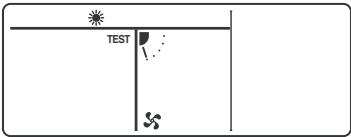
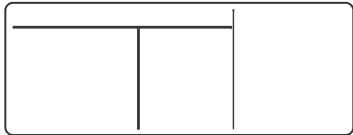
Procedure	Operation contents
1	<p>Push [TEST] button for 4 seconds or more. [TEST] is displayed at the display part and the mode enters in TEST mode.</p> 
2	<p>Push [ON/OFF] button.</p>
3	<p>Change the mode from [COOL] to [HEAT] using [MODE] button.</p> <ul style="list-style-type: none"> Do not use [MODE] button for other mode except [COOL]/[HEAT] modes. The temperature cannot be adjusted during test run. The trouble detection is performed as usual. 
4	<p>After test run, push [ON/OFF] button to stop the operation. (Display on the display part is same to that in Procedure 1.)</p>
5	<p>Push [TEST] button to clear the TEST mode. ([TEST] display in the display part disappears and status becomes the normal stop status.)</p> 

Note) The test run returns to the normal operation after 60 minutes.

■ Check function for operation of indoor unit (Functions at indoor unit side)

This function is provided to check the operation of the indoor unit singly without communication with the remote control or the outdoor unit. This function can be used regardless of operation or stop of the system. However, if using this function for a long time, a trouble of the equipment may be caused. Limit using this function within several minutes.

[How to operate]

- 1) Short-circuit CHK pin (CN071 on the indoor P.C. board).

The operation mode differs according to the indoor unit status in that time.

Normal time: Both float SW and fan motor are normal.

Abnormal time: Either one of float SW or fan motor is abnormal.

- 2) Restricted to the normal time, if short-circuiting DISP pin (CN072 on the indoor P.C. board) in addition to short-circuit of CHK pin (CN071 on the indoor P.C. board), the minimum opening degree (30pls) can be set to the indoor PMV only.

When open DISP pin, the maximum opening degree (1500pls) can be obtained again.

[How to clear]

Open CHK pin. While the system is operating, it stops once but automatically returns to operation after several minutes.

	Short-circuit of CHK pin(CN071)		
	Normal time		Abnormal time
	DISP pin open(CN071)	DISP pin short circuit(CN071)	
Fan motor	(H)	(H)	Stop
Indoor PMV (*)	Max. opening degree (1500pls)	Min. opening degree (30pls)	Min. opening degree (30pls)
Communication	All ignored	All ignored	All ignored
P.C. board LED	Lights	Lights	Flashes

9-3. Method to Set Indoor Unit Function DN Code

(When performing this task, be sure to use a wired remote control)

<Procedure> To be performed only when system at rest

- 1 Push the  +  +  buttons simultaneously and hold for at least 4 seconds.

The unit No. displayed first is the address of the header indoor unit in group control.

Then the fan and louver of the selected indoor unit move.

- 2 Each time the “Select unit” side of the  button (button of left side) is pushed, one of the indoor unit Nos. under group control is displayed in turn. Then the fan of the selected indoor unit move.

- 3 Use the  button to select the CODE No. (DN code) of the desired function.

- 4 Use the  button to select the desired SET DATA associated with the selected function.

- 5 Push the  button. (The display changes from flashing to steady.)

- To change the selected indoor unit, go back to step 2.
- To change the selected function, go back to step 3.

- 6 When the  button is pushed, the system returns to normal off state.

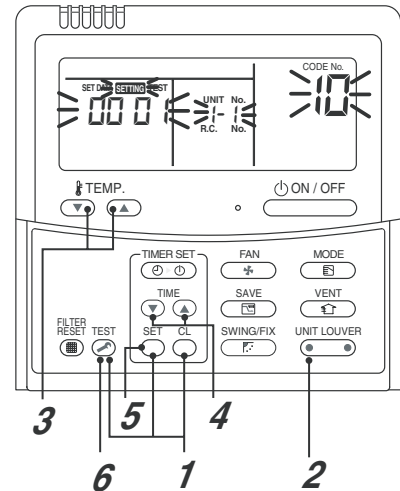

Function Select Item No. (DN) Table
(Indicates items necessary to perform the applicable control at local site)

DN	Item	Contents	At shipment from factory
01	Filter sign lighting time	0000: None 0002: 2500H 0004: 10000H 0001: 150H 0003: 5000H	0002: 2500H
02	Filter dirty degree	0000: Standard 0001: Heavy dirt (Half of standard time)	0000: Standard
03	Central control address	0001: No.1 unit ~ 0064: No.64 unit 0099: Undefined	0099: Undefined
04	Priority to specific indoor air conditioner	0000: No priority 0001: Priority	0000: No priority
0d	Cooling/Heating AUTO mode provided / None	0000: AUTO Cooling/Heating provided 0001: No AUTO Cooling/Heating (Automatic selection by connected outdoor unit)	0001: No AUTO Cooling/Heating
0F	Cooling only	0000: Heat pump 0001: Cooling only (No [AUTO] [HEAT] display)	0000: Heat pump
10	Type	0000: (1-way Air Discharge Cassette Type) 0001: (4-way Air Discharge Cassette Type) ~ 0037	0016: Outside Air Unit
11	Indoor air conditioner capacity	0000: Undefined 0001 ~ 0034	According to capacity type
12	Line address	0001: No.1 unit ~ 0028: No.28 unit	0099: Undefined
13	Indoor air conditioner address	0001: No.1 unit ~ 0064: No.64 unit	0099: Undefined
14	Group address	0000: Single 0002: Group follower 0001: Group master	0099: Undefined
28	Automatic reset of power failure	0000: None 0001: Provided	0000: None
2E	HA terminal (T10) selection	0000: Normal (JEMA) 0001: Card input (shuffling omission)	0000: Normal (HA terminal)
31	Fan (Single operation)	0000: Unavailable 0001: Available	0000: Unavailable
C8	Outside Air Unit	0000: Undefined 0001: Mixed	0001: Mixed
60	Timer setting (wired remote control)	0000: Available (can be performed) 0001: Unavailable (cannot be performed)	0000: Available
92	Outside interlock release condition	0000: Operation stop 0001: Release communication signal receive	0000: Operation stop

Type
DN code “10”

Value	Type	Model
0016	Outside Air Unit	MMD-AP***HF2UL

*1Default value stored in EEPROM mounted on service P.C. board

Indoor Unit Capacity
DN code “11”

Value	Capacity
0000*	Invalid
0017	048 type
0021	072 type
0023	096 type
~	—

*1 Default value stored in EEPROM mounted on service P.C. board

9-4. Applied Control in Indoor Unit

Remote location ON/OFF control box (TCB-IFCB-4UL)

[Wiring and setup]

- Use the exclusive connector for connection with the indoor control P.C. board.
- In a group control, the system can operate when connecting with any indoor unit (Control P.C. board) in the group. However when taking out the operation/trouble signal from the other unit, it is necessary to take out from each unit individually.

1. Control items

- 1) Start/Stop input signal : Operation start/stop in unit
- 2) Operation signal : Output during normal operation
- 3) Trouble signal : Output during alarm
(Serial communication trouble or indoor/outdoor protective device) operation

2. Wiring diagram using remote control interface (TCB-IFCB-4UL)

Input IFCB-4UL : No voltage ON/OFF serial signal
 Output No voltage contact for operation, check display
 Contact capacity: Below Max. AC240V 0.5A

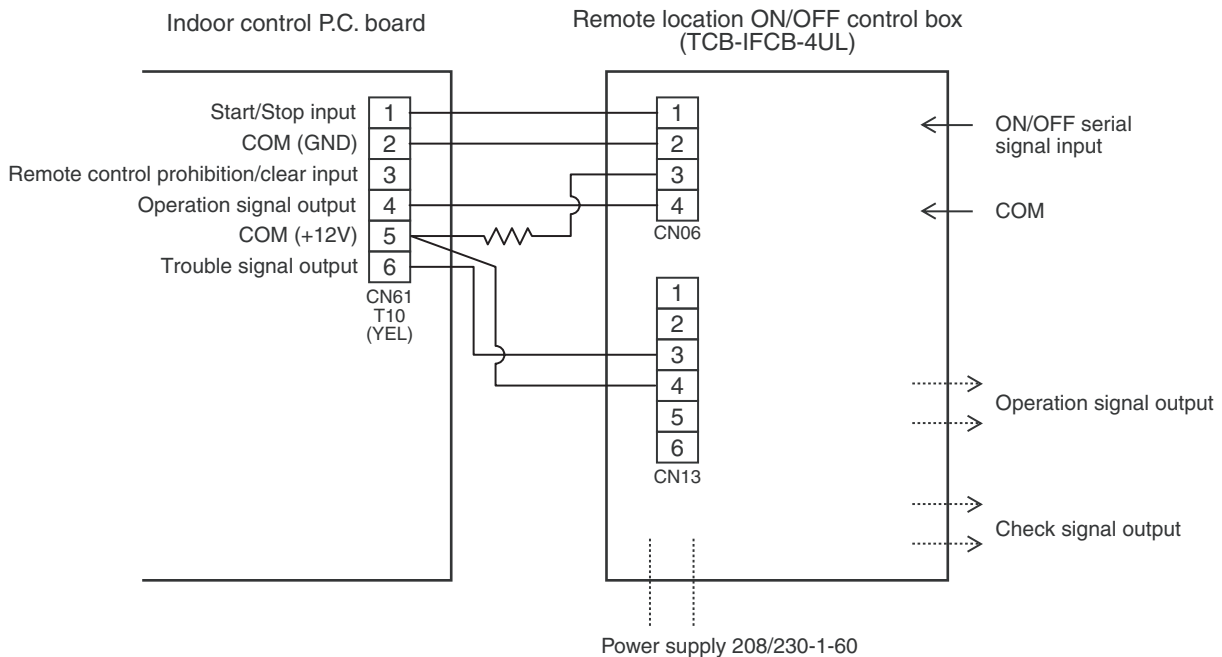

■ Ventilating fan control from remote control

[Function]

- The start/stop operation can be operated from the wired remote control when air to air heat exchanger or ventilating fan is installed in the system.
- The fan can be operated even if the indoor unit is not operating.
- Use a fan which can receive the no-voltage A contact as an outside input signal.
- In a group control, the units are collectively operated and they can not be individually operated.

1. Operation

Handle a wired remote control in the following procedure.

- * Use the wired remote control when turning off the system.
- * Be sure to set up the wired remote control to the header unit. (Same in group control)
- * In a group control, if the wired remote control is set up to the header unit, both header and follower units are simultaneously operable.

1 Push concurrently + + buttons for 4 seconds or more.

The unit No. displayed firstly indicates the header indoor unit address in the group control. In this time, the fan of the selected indoor unit turns on.

2 Every pushing button (button of left side), the indoor unit numbers in group control are displayed successively.

In this time, the fan of the selected indoor unit only turns on.

3 Using the temperature setup / button, specify the CODE No. 31.

4 Using the timer time / button, select the SET DATA. (At shipment: 0000)

The setup data are as follows:

SET DATA	Handling of operation of air to air heat exchanger or ventilating fan
0000	Unavailable (At shipment)
0001	Available

5 Push button. (OK if display goes on.)

- To change the selected indoor unit, go to the procedure 2).
- To change the item to be set up, go to the procedure 3).

6 Pushing returns the status to the usual stop status.

2. Wiring

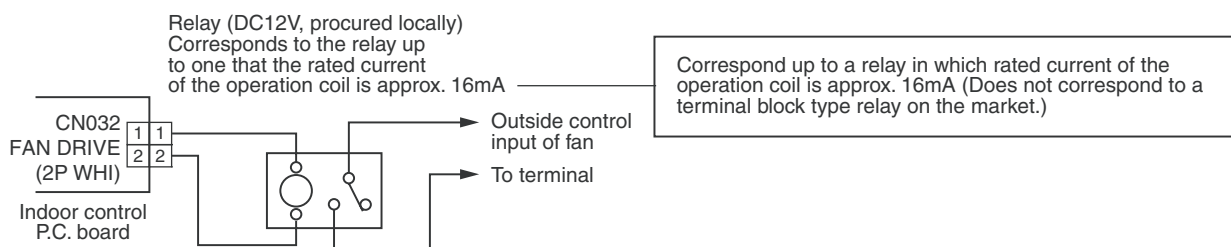

Note) Determine the cable length between the indoor control P.C. board and the relay within 2m.

■ Leaving-ON prevention control

[Function]

- This function controls the indoor units individually. It is connected with cable to the control P.C. board of the indoor unit.
- In a group control, it is connected with cable to the indoor unit (Control P.C. board), and the CODE No. 2E is set to the connected indoor unit.
- It is used when the start operation from outside is unnecessary but the stop operation is necessary.
- Using a card switch box, card lock, etc, the indoor unit can be protected if it is forgotten to be turned off.
- When inserting a card, start/stop operation from the remote control is allowed.
- When taking out a card, the system stops if the indoor unit is operating and start/stop operation from the remote control is forbidden.

1. Control items





- 1) Outside contact ON : The start/stop operation from the remote control is allowed.
(Status that card is inserted in the card switch box)
- 2) Outside contact OFF : If the indoor unit is operating, it is forced to stop.
(Start/Stop prohibited to remote control)
(Status that card is taken out from the card switch box)

*When the card switch box does not perform the above contact operation, convert it using a relay with b contact.

2. Operation

Handle the wired remote control switch in the following procedure.

*Use the wired remote control switch when the system is being turned off.

- 1 Push concurrently  +  +  buttons for 4 seconds or more.
- 2 Using the temperature setup  /  button, specify the CODE No. 2E .
- 3 Using the timer time  /  button, set 000 l to the setup data.
- 4 Push  button.
- 5 Push  button. (The status returns to the usual stop status.)

3. Wiring

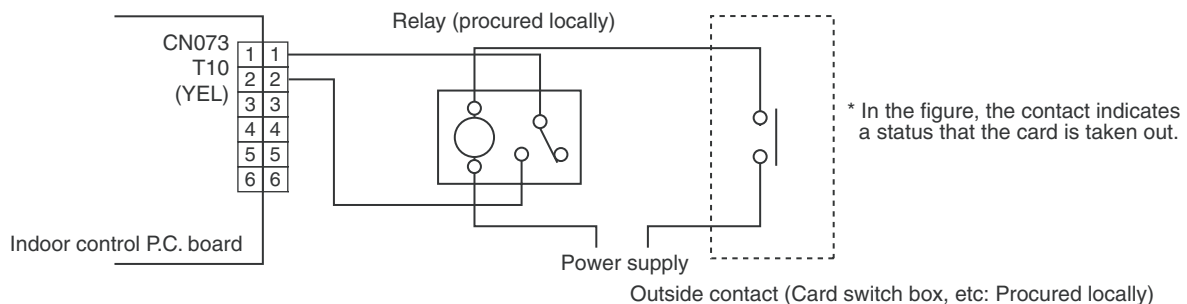

■ Power peak-cut from indoor unit

When the relay is turned on, a forced thermostat-OFF operation starts.

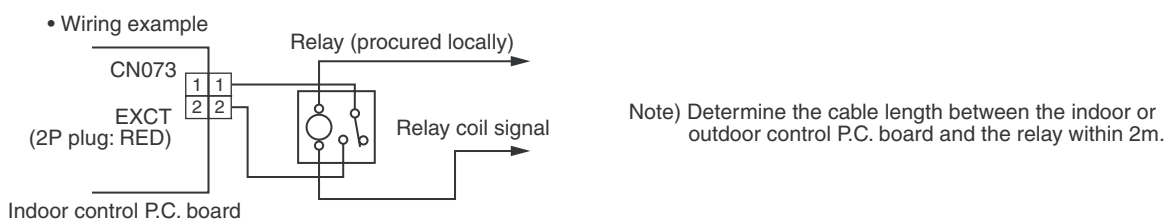

■ Address setup (Manual setting from Wired remote control)

In case that addresses of the indoor units will be determined prior to piping work after wiring work

- Set an indoor unit per a remote control.
- Turn on power supply.

1 Push **SET** + **CL** + **TEST** buttons simultaneously for 4 seconds or more.

2 (Line address)
Using the temperature setup **▼** / **▲** buttons, set **12** to the CODE No.

3 Using timer time **▼** / **▲** buttons, set the line address.

4 Push **SET** button. (OK when display goes on.)

5 (Indoor unit address)
Using the temperature setup **▼** / **▲** buttons, set **13** to the CODE No.

6 Using timer time **▼** / **▲** buttons, set 1 to the line address.

7 Push **SET** button. (OK when display goes on.)

8 (Group address)
Using the temperature setup **▼** / **▲** buttons, set **14** to the CODE No.

9 Using timer time **▼** / **▲** buttons, set **0000** to Individual, **0001** to Header unit and **0002** to follower unit.

10 Push **SET** button. (OK when display goes on.)

11 Push **TEST** button.
Setup completes.
(The status returns to the usual stop status.)

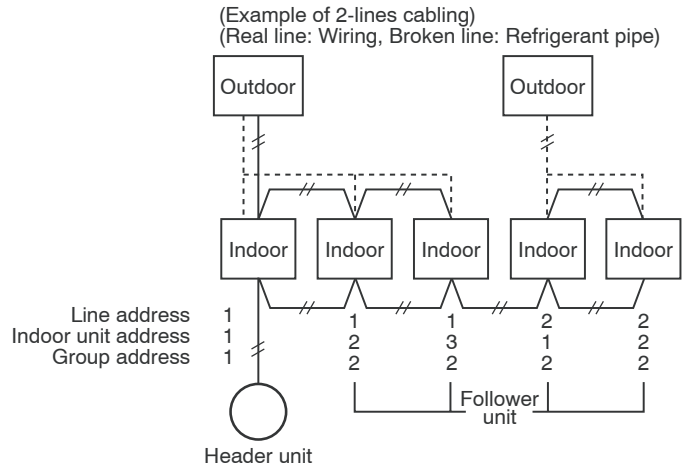

For the above example, perform setting by connecting singly the wired remote control without remote control inter-unit cable.

Group address	
Individual	: 0000
Header unit	: 0001
Follower unit	: 0002

} In case of group control

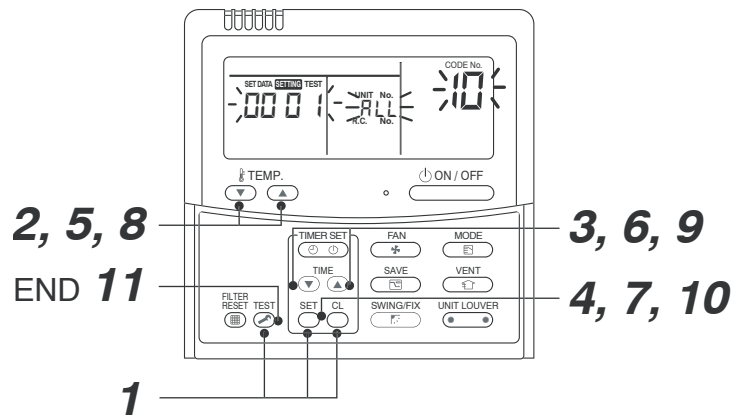

<Operation procedure>

1 → 2 → 3 → 4 → 5 → 6 →
7 → 8 → 9 → 10 → 11 END

Note 1)

When setting the line address from the remote control, do not use Address 29 and 30.

As they are addresses which cannot be set to the outdoor unit, if they are set, the check code [E04] (Indoor/Outdoor communication circuit trouble) is issued.

Note 2)

When an address was manually set from the remote control and the central control over the refrigerant lines is carried out, perform the following setting for the Header unit of each line.

- Set the line address for every line using SW13 and 14 on the interface P.C. board of the Header unit in each line.
- Except the least line address No., turn off SW30-2 on the interface P.C. board of the Header units in the lines connected to the identical central control.
(Draw the terminal resistances of indoor/outdoor and central control line wirings together.)
- For each refrigerant line, connect the relay connector between Header unit [U1U2] and [U3U4] terminals.
- After this, set the central control address.
(For setting of the central control address, refer to the Installation manual for the central control equipment.)

Confirmation of indoor unit No. position

1. To know the indoor unit addresses though position of the indoor unit is recognized

- In case of individual operation (Wired remote control : indoor unit = 1 : 1)
(Follow to the procedure during operation)

<Procedure>

1 Push  button if the unit stops.

2 Push  button (button of left side).

Unit No. 1-1 is displayed on LCD.

(It disappears after several seconds.)

The displayed unit No. indicate line address and indoor unit address.

(When other indoor units are connected to the identical remote control (Group control unit), other unit numbers are also displayed every pushing

 button(button of left side).

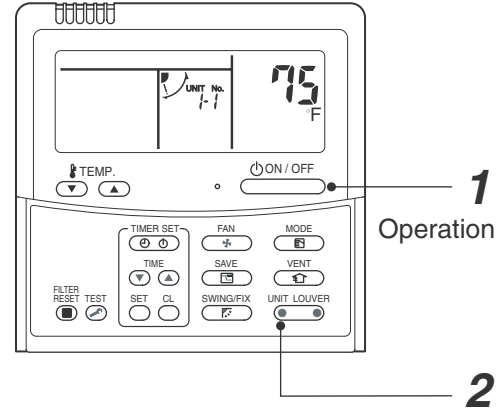

<Operation procedure>

1 → 2 END

2. To know the position of indoor unit by address

- To confirm the unit No. in the group control
(Follow to the procedure during operation) (in this procedure, the indoor units in group control stop.)

<Procedure>

The indoor unit numbers in the group control are successively displayed, and fan, louver, and drain pump of the corresponding indoor unit are turned on.
(Follow to the procedure during operation)

1 Push  and  buttons simultaneously for 4 seconds or more.

- Unit No. ALL is displayed.
- Fans of all the indoor units in the group control operate.

2 Every pushing  button(button of left side), the unit numbers in the group control are successively displayed.

- The unit No. displayed at the first time indicates the master unit address.
- Fan of the selected indoor unit only operate.

3 Push  button to finish the procedure. All the indoor units in the group control stop.

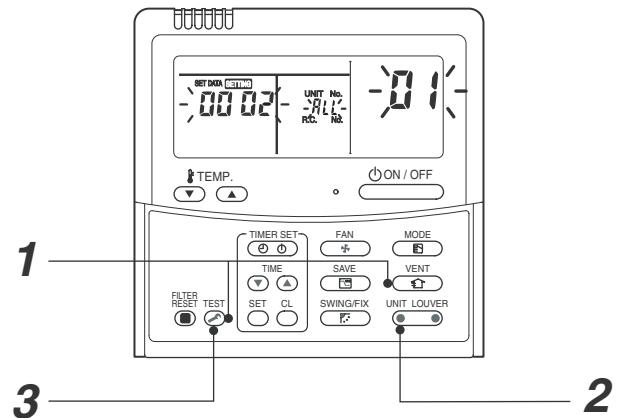

<Operation procedure>

1 → 2 → 3 END

■ How to check all the unit No. from an arbitrary wired remote control

<Procedure> Carry out this procedure when the system is turned off.

The indoor unit No. and the position in the identical refrigerant piping can be checked.

An outdoor unit is selected, the identical refrigerant piping and the indoor unit No. are displayed one after the other, and then its fan is on.

- 1 Push the timer time button + simultaneously for 4 seconds or more.
First line 1 and CODE No. **RC** (Address Change) are displayed. (Select outdoor unit.)



- 2 Select line address using / button.



- 3 Determine the selected line address using button.

- The address of the indoor unit connected to the refrigerant piping of the selected outdoor unit is displayed and the fan is on.



- 4 Every pushing button (button of left side), the indoor unit No. in the identical piping is displayed one after the other.

- Only fan of the selected indoor unit start operation.



[To select the other line address]

- 5 Push button and the operation returns to Procedure 2.

- * The indoor address of other line can be continuously checked.



- 6 Push button and then the procedure finishes.

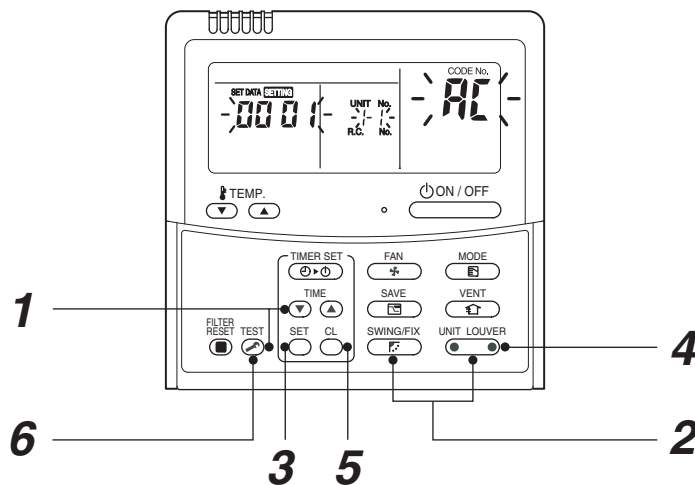





<Operation procedure>

1 → 2 → 3 → 4 → 5 → 6 END



■ How to change an indoor unit address by using a wired remote control

Use this method to change the address of indoor units (one to one or group control) that have had the original address set automatically.



This procedure must be done while the units are not operating.

- 1 Simultaneously push and hold the “SET ↓
- 2 Push ↓
- 3 Push the TEMP.  /  buttons repeatedly to select  for CODE No.

↓

- 4 Push the TIME  /  buttons repeatedly to change the value indicated in the SET DATA section.

↓

- 5 Push the “SET ↓
- 6 Push ↓
- 8 If the addresses have been changed correctly, push the “TEST 

The diagram shows the control panel of an indoor unit with the following callouts:

 - 1**: Points to the SET, CL, and TEST buttons.
 - 2, 6, 7**: Points to the UNIT LOUVER button.
 - 3**: Points to the TEMP. up/down buttons.
 - 4**: Points to the TIME up/down buttons.
 - 5**: Points to the SET button.
 - 8**: Points to the TEST button.

■ How to change all indoor addresses from an arbitrary wired remote control

(It is possible when setting has finished by automatic addresses.)

Contents: The indoor unit addresses in each identical refrigerant piping line can be changed from an arbitrary wired remote control.

☉ Enter in address check/change mode and then change the address.

<Procedure> Carry out this procedure during stop of system.

1 Push the timer time button + simultaneously for 4 seconds or more. First line 1 and CODE No. **AC** (Address Change) are displayed.



2 Select line address using / button.



3 Push the button.

- The address of the indoor unit connected to the refrigerant piping of the selected outdoor unit is displayed and the fan is on. First the current indoor address is displayed. (Line address is not displayed.)



4 button push up/down the indoor address of the SET DATA.

The set data is changed to a new address.



5 Push button to determine the set data.



6 Every pushing button (button of left side), the indoor unit No. in the identical piping is displayed one after the other.

- Only fan of the selected indoor unit start operation. Repeat the Procedures 4 to 6 to change all the indoor addresses so that they are not duplicated.



7 Push button. (All the indications of LCD go on.)



8 Push button and then the procedure finishes.

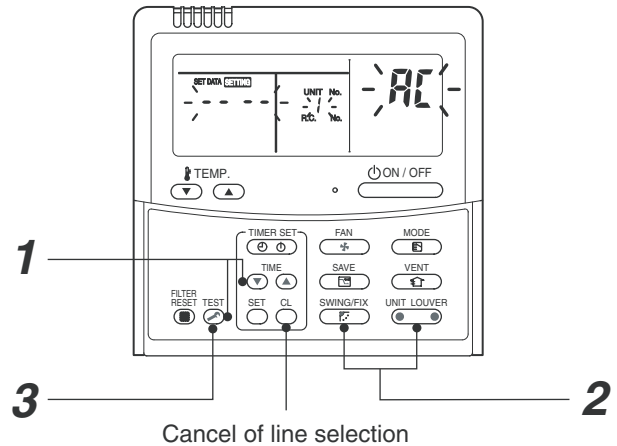

If the UNIT No. is not called up here, the outdoor unit in that line does not exist.

Push button to select a line again in the Procedure 2.

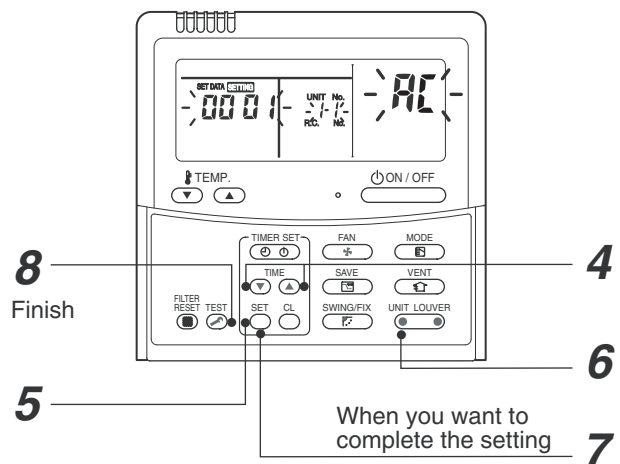

<Operation procedure>

1 → **2** → **3** → **4** → **5** →
6 → **7** → **8** END

■ Function to clear the check code

1. Clearing method from remote control

◎ How to clear the check code of outdoor unit

The currently detected check code of the outdoor unit is cleared by using the service monitor function of the remote control. (Check code of the indoor unit is not cleared.)

(Only the check code of the outdoor unit in one refrigerant line system is cleared.)

<Method>

- 1** Push **CL** + **TEST** buttons simultaneously for 4 seconds or more to change the mode to service monitor mode.
- 2** Push **TEMP.** button to set the item code to [FF].
- 3** The display of A part in the following figure is counted as "0005" → "0004" → "0003" → "0002" → "0001" → "0000" with 5-seconds interval. When "0000" appear, the check code was cleared.
* However counting from "0005" is repeated on the display screen.
- 4** When pushing **TEST** button, the status becomes normal.

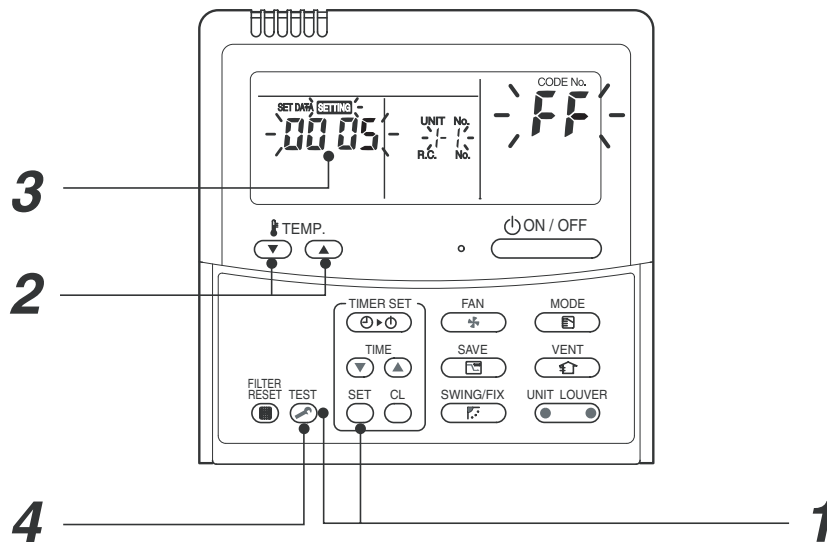

<Operation procedure>

1 → 2 → 3 → 4

Returns to normal status

◎ How to clear the check code of indoor unit

The check code of indoor unit is cleared by **ON/OFF** button of the remote control.

(Only the check code of the indoor unit connected with remote control to be operated is cleared.)

■ Monitoring function of remote control switch

When using the remote control (Model Name: RBC-AMT32UL), the following monitoring function can be utilized.

Calling of display

<Contents>

The temperature of each sensor of the remote control, indoor unit and outdoor unit and the operating status can be checked by calling the service monitor mode from the remote control.

<Procedure>

- 1 Push **TEST** + **CL** buttons simultaneously for 4 seconds or more to call up the service monitor mode.

The service monitor goes on and firstly the temperature of the CODE No. **00** is displayed.



- 2 Push **TEMP.** button to change CODE No. (CODE No.) to the CODE No. to be monitored. For display code, refer to the following table.



- 3 Push **UNIT LOUVER** button (button of left side) to change to item to be monitored. The sensor temperature of indoor unit or outdoor unit in its refrigerant line and the operating status are monitored.



- 4 Push **TEST** button to return the status to the normal display.

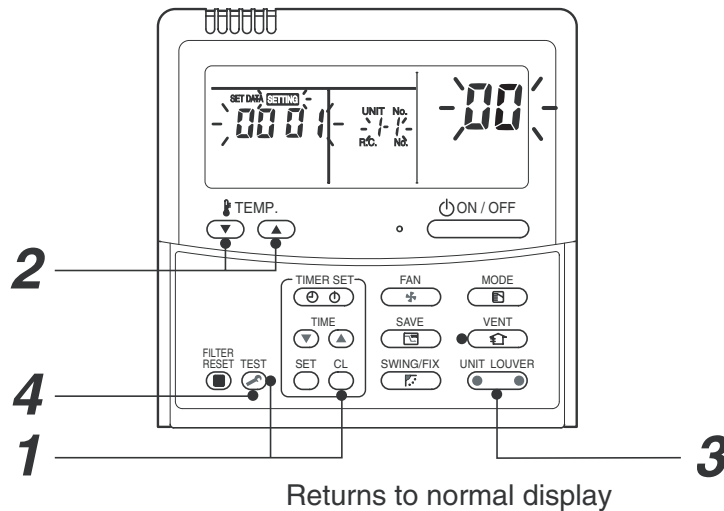

<Operation procedure>

1 → 2 → 3 → 4

< Based on the SMMS-e >

	CODE No.	Data name	Display format	Unit	Remote control display example
Indoor unit data *3	00	Room temperature(Use to control)	×1	°C	[0027] = 27°C
	01	Room temperature(Remote control)	×1	°C	
	02	Indoor suction air temperature (TA)*1	×1	°F	[0080] = 80°F
	03	Indoor coil temperature (TCJ)*1	×1	°F	
	04	Indoor coil temperature (TC2)*1	×1	°F	
	05	Indoor coil temperature (TC1)*1	×1	°F	
	06	Indoor discharge air temperature (TF)*2	×1	°F	
	08	Indoor PMV opening	×1/10	pls	[0150] = 1500pls
	F3	Filter sign time	×1	h	[2500] = 2500h
System data	0A	No. of connected indoor units	×1	unit	[0048] = 48units
	0B	Total capacity of connected indoor units	×10	ton	[0215] = 21.5ton
	0C	No. of connected outdoor units	×1	unit	[0003] = 3units
	0D	Total capacity of connected outdoor units	×10	ton	[0160] = 16ton

	CODE No.	Data name	Display format	Unit	Remote control display example		
	U1	U2	U3				
Outdoor unit individual data 1 *4	10	20	30	High-pressure sensor detention pressure (Pd)	×10	psi	[4350] = 435 psi
	11	21	31	Low-pressure sensor detention pressure (Ps)	×10	psi	
	12	22	32	Compressor 1 discharge temperature (TD1)	×1	°F	[0080] = 80 °F
	13	23	33	Compressor 2 discharge temperature (TD2)	×1	°F	
	15	25	35	Outdoor coil temperature (TE1)	×1	°F	
	16	26	36	Outdoor coil temperature (TE2)	×1	°F	
	17	27	37	Outdoor coil temperature (TG1)	×1	°F	
	18	28	38	Outdoor coil temperature (TG2)	×1	°F	
	19	29	39	Outside ambient temperature (TO)	×1	°F	
	1A	2A	3A	Suction temperature (TS1)	×1	°F	
	1C	2C	3C	Suction temperature (TS3)	×1	°F	
	1D	2D	3D	Temperature at liquid side (TL1)	×1	°F	
	1E	2E	3E	Temperature at liquid side (TL2)	×1	°F	
	1F	2F	3F	Temperature at liquid side (TL3)	×1	°F	

	CODE No.	Data name	Display format	Unit	Remote control display example		
	U1	U2	U3				
Outdoor unit individual data 2 *4	50	60	70	PMV1 opening	×1	pls	[0500] = 500pls
	51	61	71	PMV3 opening	×1	pls	
	52	62	72	PMV4 opening	×1	pls	
	53	63	73	1 fan model : Compressor 1 current (I1) 2 fan model : Compressor 1 and Outdoor fan 1 current (I1)	×10	A	[0135] = 13.5A
	54	64	74	1 fan model : Compressor 2 and Outdoor fan 1 current (I2) 2 fan model : Compressor 2 and Outdoor fan 2 current (I2)	×10	A	
	56	66	76	Compressor 1 revolutions	×10	rps	[0642] = 64.2rps
	57	67	77	Compressor 2 revolutions	×10	rps	
	59	69	79	Outdoor fan mode	×1	mode	[0058] = 58 mode
	5A	6A	7A	Compressor IPDU 1 heat sink temperature	×1	°F	[0024] = 24 oF
	5B	6B	7B	Compressor IPDU 2 heat sink temperature	×1	°F	
	5D	6D	7D	Outdoor fan IPDU 1 heat sink temperature	×1	°F	
	5E	6E	7E	Outdoor fan IPDU 2 heat sink temperature	×1	°F	
	5F	6F	7F	Outdoor unit capacity	×10	ton	[0080] = 8 ton
	90	-	-	Heating/cooling recovery controlled	0:Normal		[0010]=Heating recovery controlled
	91	-	-	Pressure release	0:Normal		[0010]=Pressure release controlled
	92	-	-	Pressure release	1:Release controlled		[0001]=Discharge temperature release controlled
	93	-	-	Follower unit release (U2/U3 outdoor units)	1:Release controlled		[0100]=U2 outdoor unit release controlled

*1 The Outside Air Unit uses the revised sensor data, therefore the data below are not correctly displayed because they are revised sensor data.

- Indoor suction air temperature (TA)
- Indoor coil temperature (TCJ)
- Indoor coil temperature (TC2)
- Indoor coil temperature (TC1)

*2 Only a part of indoor unit types is installed with the discharge air temperature sensor. This temperature is not displayed for other types.

*3 When the units are connected to a group, data of the header indoor unit only can be displayed.

*4 The indications, U1, U2, U3 indicate the following outdoor units, respectively. For the indication data of each outdoor unit, check CODE No.

- U1...outdoor unit (Header unit)
- U2...outdoor unit (Follower unit 1)
- U3...outdoor unit (Follower unit 2)

< Based on the SMMS-i >

	CODE No.	Data name	Display format	Unit	Remote control display example
Indoor unit data *3	00	Room temperature(Use to control)	×1	°C	[0027] = 27°C
	01	Room temperature(Remote control)	×1	°C	
	02	Indoor suction air temperature (TA)*1	×1	°F	[0080] = 80°F
	03	Indoor coil temperature (TCJ)*1	×1	°F	
	04	Indoor coil temperature (TC2)*1	×1	°F	
	05	Indoor coil temperature (TC1)*1	×1	°F	
	06	Indoor discharge air temperature (TF)*2	×1	°F	
	08	Indoor PMV opening	×1/10	pls	[0150] = 1500pls
F3	Filter sign time	×1	h	[2500] = 2500h	
System data	0A	No. of connected indoor units	×1	unit	[0048] = 48units
	0B	Total capacity of connected indoor units	×10	ton	[0215] = 21.5ton
	0C	No. of connected outdoor units	×1	unit	[0003] = 3units
	0D	Total capacity of connected outdoor units	×10	ton	[0160] = 16ton

	CODE No.			Data name	Display format	Unit	Remote control display example
	U1	U2	-				
Outdoor unit individual data 1 *4	10	20	-	High-pressure sensor detention pressure (Pd)	×10	psi	[4350] = 435 psi
	11	21	-	Low-pressure sensor detention pressure (Ps)	×10	psi	
	12	22	-	Compressor 1 discharge temperature (TD1)	×1	°F	[0080]= 80 °F
	13	23	-	Compressor 2 discharge temperature (TD2)	×1	°F	
	14	24	-	Compressor 3 discharge temperature (TD3)	×1	°F	
	15	25	-	Suction temperature (TS1)	×1	°F	
	16	26	-	Outdoor coil temperature (TE1)	×1	°F	
	17	27	-	Outdoor coil temperature (TE2)	×1	°F	
	18	28	-	Outdoor coil temperature (TL)	×1	°F	
	19	29	-	Outside ambient temperature (TO)	×1	°F	
	1A	2A	-	PMV1,2 opening	×1	pls	[0500] = 500pls
	1B	2B	-	PMV4 opening	×1	pls	
	1C	2C	-	Compressor 1 curent (I1)	×10	A	[0135] = 13.5A
	1D	2D	-	Compressor 1 curent (I2)	×10	A	
	1E	2E	-	Compressor 1 curent (I3)	×10	A	

	CODE No.			Data name	Display format	Unit	Remote control display example
	U1	U2	-				
Outdoor unit individual data 2 *4	50	60	-	Compressor 1 revolutions	×10	rps	[0642] = 64.2rps
	51	61	-	Compressor 2 revolutions	×10	rps	
	52	62	-	Compressor 3 revolutions	×10	rps	
	53	63	-	Outdoor fan mode	×1	mode	[0500] = 500pls
	54	64	-	Compressor IPDU 1 heat sink temperature	×1	°F	[0024] = 24 °F
	55	65	-	Compressor IPDU 2 heat sink temperature	×1	°F	
	56	66	-	Compressor IPDU 3 heat sink temperature	×1	°F	
	57	67	-	Outdoor fun IPDU 1 heat sink temperature	×1	°F	
	58	68	-	Heating/cooling recovery controlled	0:Normal		[0010]=Heating recovery controlled
	5B	6B	-	Pressure release	0:Normal		[0010]=Pressure release controlled
	5D	6D	-	Pressure release	1:Release controlled		[0001]=Discharge temperature release controlled
	5E	6E	-	Follower unit release (U2/U3 outdoor units)			[0100]=U2 outdoor unit release controlled

*1 The Outside Air Unit uses the revised sensor data, therefore the data below are not correctly displayed because they are revised sensor data.

- Indoor suction air temperature (TA)
- Indoor coil temperature (TCJ)
- Indoor coil temperature (TC2)
- Indoor coil temperature (TC1)

*2 Only a part of indoor unit types is installed with the discharge air temperature sensor. This temperature is not displayed for other types.

*3 When the units are connected to a group, data of the header indoor unit only can be displayed.

*4 The indications, U1, U2, U3 indicate the following outdoor units, respectively. For the indication data of each outdoor unit, check CODE No.

- U1...outdoor unit (Header unit)
- U2...outdoor unit (Follower unit 1)
- U3...outdoor unit (Follower unit 2)



■ Changing of settings for Celsius display

- Push  button if the unit stops.

Procedure 1

Push simultaneously  +  +  buttons for 4 seconds or more.

After a while, the display part flashes as shown right. Check the displayed CODE No. is [10].

- When the CODE No. is other than [10], push  button to erase the display and repeat procedure from the first step. (After pushing  button, operation of the remote control is not accepted for approx. 1 minute.)
(For a group control, No. of the firstly displayed indoor unit becomes the header unit.)

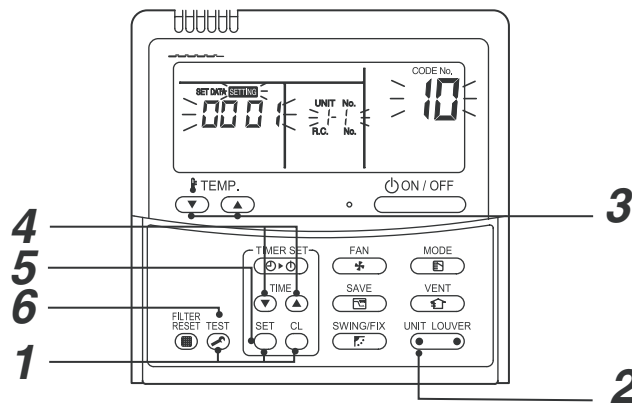



Procedure 2

Every time the button is pushed,  (button at left side), the indoor unit No. in the group control is displayed in order. Select the indoor unit of which setup is changed.

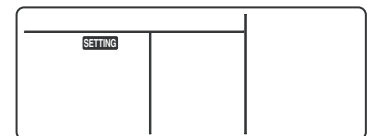
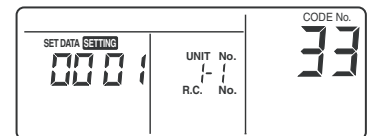
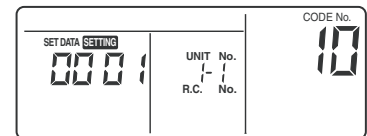
In this time, the position of the indoor unit of which setup is changed can be confirmed because fan of the selected indoor unit will operate.



Procedure 3

1. Using temp. setup  buttons, specify CODE No. [33].
(CODE No. [33]: Fahrenheit display)
2. Using timer  buttons, change the line address from [000 !] to [0000]
3. Push  button. In this time, the setup finishes when the display changes from flashing to lighting.

Procedure 4

After verifying the content change, push  button. (Setup is determined.)

When pushing  button, the display disappears and the status becomes the usual stop status.

(When pushing  button the operation from the remote control is not accepted for approx. 1 minute.)

- If the operation from the remote control is not accepted after 1 minute of pushing the  button, it is considered that the address setup is incorrect. In this case, the automatic address must be set up again.

When changing the settings from Celsius to Fahrenheit follow the reverse order of the above procedure.

10. TROUBLESHOOTING

10-1. Overview

(1) Before engaging in troubleshooting

(a) Applicable models

All Super Module Multi (SMMS-i, SMMS-e) models.

(Indoor units: MM*-AP***, Outdoor units: MMY-MAP****)

(b) Tools and measuring devices required

- Screwdrivers (Philips, flat head), spanners, long-nose pliers, nipper, pin to push reset switch, etc.
- Multimeter, thermometer, pressure gauge, etc.

(c) Things to check prior to troubleshooting (behaviors listed below are normal)

NO.	Behavior	Possible cause
1	A compressor would not start	<ul style="list-style-type: none"> • Could it just be the 3-minute delay period (3 minutes after compressor shutdown)? • Could it just be the air conditioner having the thermostat set to OFF? • Could it just be the air conditioner operating in fan mode or put on the timer? • Could it just be the system going through initial communication?
2	An indoor fan would not start	<ul style="list-style-type: none"> • Isn't the outside temp out of range of use temperature?
3	An outdoor fan would not start or would change speed for no reason	<ul style="list-style-type: none"> • Could it just be cooling operation under low outside temperature conditions? • Could it just be defrosting operation?
4	An indoor fan would not stop	<ul style="list-style-type: none"> • Could it just be the elimination of residual heat being performed as part of the air conditioner shutdown process after heating operation?
5	The air conditioner would not respond to a start/stop command from a remote control	<ul style="list-style-type: none"> • Could it just be the air conditioner operation under external or remote control?

(2) Troubleshooting procedure

When a trouble occurs, proceed with troubleshooting in accordance with the procedure shown below.

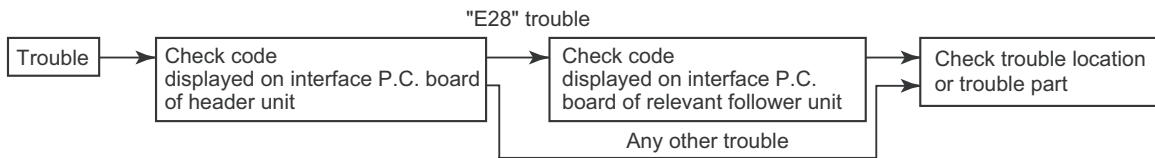

NOTE

Rather than a genuine trouble (see the List of Check Codes below), the problem could have been caused by a microprocessor malfunction attributable to a poor quality of the power source or an external noise. Check for possible noise sources, and shield the remote control wiring and signal wires as necessary.

10-2. Troubleshooting Method

The remote controls (main remote control and central control remote control) and the interface P.C. board of an outdoor unit are provided with an LCD display (remote control) or a 7-segment display (outdoor interface P.C. board) to display operational status. Using this self-diagnosis feature, the problem may be identified in the event of a problem by following the method described below.

The list below summarizes check codes detected by various devices. Analyze the check code according to where it is displayed and work out the nature of the problem in consultation with the list.

- When investigating a problem on the basis of a display provided on the indoor remote control or TCC-LINK central control remote control - See the “TCC-LINK remote control or main remote control display” section of the list.
- When investigating a problem on the basis of a display provided on an outdoor unit - See the “Outdoor 7-segment display” section of the list.
- When investigating a problem on the basis of a wireless remote control-controlled indoor unit - See the “Light sensor indicator light block” section of the list.

List of Check Codes (Indoor Unit)

(Check code detected by indoor unit)

IPDU: Intelligent Power Drive Unit (Inverter P.C. board)

○ : Lighting, ◎ : Flashing, ● : Goes off

ALT.: Flashing is alternately when there are two flashing LED

SIM: Simultaneous flashing when there are two flashing LED

Check code			Display of receiving unit				Typical problem site	Description of Check code
TCC-LINK central control or main remote control display	Outdoor 7-segment display		Indicator light block					
		Sub-code	Operation Ⓛ	Timer Ⓜ	Ready Ⓢ	Flash		
E03	–	–	◎	●	●		Indoor-remote control periodic communication trouble	Communication from remote control or network adaptor has been lost (so has central control communication).
E04	–	–	●	●	◎		Indoor-outdoor periodic communication trouble	Signals are not being received from outdoor unit.
E08	E08	Duplicated indoor address	◎	●	●		Duplicated indoor address	Indoor unit detects address identical to its own.
E10	–	–	◎	●	●		Indoor inter-MCU communication trouble	MCU communication between main control and motor microcontroller is faulty.
E18	–	–	◎	●	●		Trouble in periodic communication between indoor header and follower unit	Periodic communication between indoor header and follower units cannot be maintained.
F01	–	–	◎	◎	●	ALT	Indoor heat exchanger temperature sensor (TCJ) trouble	Heat exchanger temperature sensor (TCJ) has been open/short-circuited.
F02	–	–	◎	◎	●	ALT	Indoor heat exchanger temperature sensor (TC2) trouble	Heat exchanger temperature sensor (TC2) has been open/short-circuited.
F03	–	–	◎	◎	●	ALT	Indoor heat exchanger temperature sensor (TC1) trouble	Heat exchanger temperature sensor (TC1) has been open/short-circuited.
F10	–	–	◎	◎	●	ALT	Room air temperature sensor (TA/TSA) trouble	Room air temperature sensor (TA) has been open/short-circuited.
F11	–	–	◎	◎	●	ALT	Discharge air temperature sensor (TF/TFA) trouble	Discharge air temperature sensor (TF) has been open/short-circuited.
F29	–	–	◎	◎	●	SIM	P.C. board or other indoor trouble	Indoor EEPROM is abnormal (some other trouble may be detected).
L03	–	–	◎	●	◎	SIM	Duplicated indoor group header unit	There is more than one header unit in group.
L07	–	–	◎	●	◎	SIM	Connection of group control cable to stand-alone indoor unit	There is at least one stand-alone indoor unit to which group control cable is connected.
L08	L08	–	◎	●	◎	SIM	Indoor group address not set	Address setting has not been performed for one or more indoor units (also detected at outdoor unit end).
L09	–	–	◎	●	◎	SIM	Indoor capacity not set	Capacity setting has not been performed for indoor unit.
L20	–	–	◎	○	◎	SIM	Duplicated central control address	There is duplication in central control address setting.
L30	L30	Detected indoor unit No.	◎	○	◎	SIM	Indoor external trouble input (interlock)	Unit shutdown has been caused by external trouble input (CN080).
P01	–	–	●	◎	◎	ALT	Indoor AC fan trouble	Indoor AC fan trouble is detected (activation of fan motor thermal relay).
P31	–	–	◎	●	◎	ALT	Other indoor unit trouble	Follower unit cannot be operated due to header unit alarm (E03/L03/L07/L08).

(Trouble detected by main remote control)

Check code			Display of receiving unit				Typical fault site	Description of trouble
Main remote control	Outdoor 7-segment display		Indicator light block					
		Sub-code	Operation ⏸	Timer ⌚	Ready ⊙	Flash		
E01	–	–	⊙	●	●		No master remote control, faulty remote control communication (reception)	Signals cannot be received from indoor unit; master remote control has not been set (including two remote control).
E02	–	–	⊙	●	●		Faulty remote control communication (transmission)	Signals cannot be transmitted to indoor unit.
E09	–	–	⊙	●	●		Duplicated master remote control	Both remote controls have been set as master remote control in two remote control control (alarm and shutdown for header unit and continued operation for follower unit)

(Trouble detected by central control device)

Check code			Display of receiving unit				Typical fault site	Description of trouble
TCC-LINK central control	Outdoor 7-segment display		Indicator light block					
		Sub-code	Operation ⏸	Timer ⌚	Ready ⊙	Flash		
C05	–	–					Faulty central control communication (transmission)	Central control device is unable to transmit signal due to duplication of central control device
C06	–	–					Faulty central control communication (reception)	Central control device is unable to receive signal.
–	–	–					Multiple network adapters	Multiple network adapters are connected to remote control communication line
C12	–	–					Blanket alarm for general-purpose device control interface	Device connected to general-purpose device control interface for TCC-LINK is faulty.
P30	–	–					As per alarm unit (see above)	Group control follower unit trouble Group follower unit is faulty (unit No. and above detail [] displayed on main remote control)

Note: The same trouble, e.g. a communication trouble, may result in the display of different check codes depending on the device that detects it.

Moreover, check codes detected by the main remote control/central control device do not necessarily have a direct impact on air conditioner operation.

List of Check Codes (Outdoor Unit)

(Check code detected by SMMS-e and SMMS-i outdoor interface)

If "HELLO" is displayed on the outdoor 7-segment for 1 minute or more, turn off the power supply once and then turn on the power supply again after 30 seconds or more. When the same symptom appears, it is considered there is a possibility of I/F board trouble.

IPDU: Intelligent Power Drive Unit (Inverter P.C. board)

○ : Lighting, ◎ : Flashing, ● : Goes off

ALT.: Flashing is alternately when there are two flashing LED

SIM: Simultaneous flashing when there are two flashing LED

Check code		Display of receiving unit				Typical problem site	Description of problem																																																																																																																																																																																																			
Outdoor 7-segment display		TCC-LINK central control or main remote control display	Indicator light block																																																																																																																																																																																																							
Sub-code			Operation ⏻	Timer ⌚	Ready ⊙	Flash																																																																																																																																																																																																				
E06	Number of indoor units from which signal is received normally	E06	●	●	◎		Signal lack of indoor unit	Indoor unit initially communicating normally fails to return signal (reduction in number of indoor units connected).																																																																																																																																																																																																		
E07	—	(E04)	●	●	◎		Indoor-outdoor communication circuit trouble	Signal cannot be transmitted to indoor units (→ indoor units left without communication from outdoor unit).																																																																																																																																																																																																		
E08	Duplicated indoor address	(E08)	◎	●	●		Duplicated indoor address	More than one indoor unit are assigned same address (also detected at indoor unit end).																																																																																																																																																																																																		
E12	01: Indoor-outdoor communication 02: Outdoor-outdoor communication	E12	◎	●	●		Automatic address starting trouble	Indoor automatic address setting is started while automatic address setting for equipment in other refrigerant line is in progress. Outdoor automatic address setting is started while automatic address setting for indoor units is in progress.																																																																																																																																																																																																		
E15	—	E15	●	●	◎		Indoor unit not found during automatic address setting	Indoor unit fails to communicate while automatic address setting for indoor units is in progress.																																																																																																																																																																																																		
E16	00: Overloading 01: Number of units connected	E16	●	●	◎		Too many indoor units connected/overloading	Combined capacity of indoor units is too large (more than 135% of combined capacity of outdoor units).																																																																																																																																																																																																		
E19	00: No header unit 02: Two or more header units	E19	●	●	◎		Trouble in number of outdoor header units	There is no or more than one outdoor header unit in one refrigerant line.																																																																																																																																																																																																		
E20	01: Connection of outdoor unit from other refrigerant line 02: Connection of indoor unit from other refrigerant line	E20	●	●	◎		Connection to other refrigerant line found during automatic address setting	Indoor unit from other refrigerant line is detected while indoor automatic address setting is in progress.																																																																																																																																																																																																		
E23	—	E23	●	●	◎		Outdoor-outdoor communication transmission trouble	Signal cannot be transmitted to other outdoor units.																																																																																																																																																																																																		
E25	—	E25	●	●	◎		Duplicated follower outdoor address	There is duplication in outdoor addresses set manually.																																																																																																																																																																																																		
E26	Address of outdoor unit from which signal is not received normally	E26	●	●	◎		Signal lack of outdoor unit	Follower outdoor unit initially communicating normally fails to do so (reduction in number of follower outdoor units connected).																																																																																																																																																																																																		
E28	Detected outdoor unit No.	E28	●	●	◎		Outdoor follower unit trouble	Outdoor header unit detects fault relating to follower outdoor unit (detail displayed on follower outdoor unit).																																																																																																																																																																																																		
E31	<table border="1" style="font-size: small;"> <thead> <tr> <th rowspan="2">Sub-code</th> <th colspan="3">A3-IPDU</th> <th colspan="3">Fan-IPDU</th> <th rowspan="2">Sub-code</th> <th colspan="3">A3-IPDU</th> <th colspan="3">Fan-IPDU</th> </tr> <tr> <th>1</th><th>2</th><th>3</th> <th>1</th><th>2</th><th>3</th> <th>1</th><th>2</th><th>3</th> <th>1</th><th>2</th><th>3</th> </tr> </thead> <tbody> <tr><td>01</td><td>○</td><td>○</td><td>○</td><td></td><td></td><td></td><td>0D</td><td>○</td><td>○</td><td>○</td><td>○</td><td>○</td><td></td></tr> <tr><td>02</td><td>○</td><td>○</td><td></td><td></td><td></td><td></td><td>0E</td><td>○</td><td>○</td><td>○</td><td>○</td><td></td><td></td></tr> <tr><td>03</td><td>○</td><td>○</td><td></td><td></td><td></td><td></td><td>0F</td><td>○</td><td>○</td><td>○</td><td>○</td><td>○</td><td></td></tr> <tr><td>04</td><td></td><td></td><td>○</td><td></td><td></td><td></td><td>11</td><td>○</td><td></td><td></td><td></td><td></td><td>○</td></tr> <tr><td>05</td><td>○</td><td>○</td><td></td><td></td><td></td><td></td><td>12</td><td>○</td><td>○</td><td></td><td></td><td></td><td>○</td></tr> <tr><td>06</td><td>○</td><td>○</td><td></td><td></td><td></td><td></td><td>13</td><td>○</td><td>○</td><td></td><td></td><td></td><td>○</td></tr> <tr><td>07</td><td>○</td><td>○</td><td>○</td><td></td><td></td><td></td><td>18</td><td></td><td></td><td></td><td></td><td></td><td>○</td></tr> <tr><td>08</td><td></td><td></td><td></td><td>○</td><td></td><td></td><td>19</td><td>○</td><td></td><td></td><td></td><td></td><td>○</td></tr> <tr><td>09</td><td>○</td><td>○</td><td></td><td></td><td></td><td></td><td>1A</td><td>○</td><td>○</td><td></td><td></td><td></td><td>○</td></tr> <tr><td>0A</td><td>○</td><td>○</td><td></td><td></td><td></td><td></td><td>1B</td><td>○</td><td>○</td><td></td><td></td><td></td><td>○</td></tr> <tr><td>0B</td><td>○</td><td>○</td><td></td><td></td><td></td><td></td><td></td><td></td><td></td><td></td><td></td><td></td><td>○</td></tr> <tr><td>0C</td><td></td><td></td><td>○</td><td>○</td><td></td><td></td><td></td><td></td><td></td><td></td><td></td><td></td><td>○</td></tr> </tbody> </table>	Sub-code	A3-IPDU			Fan-IPDU			Sub-code	A3-IPDU			Fan-IPDU			1	2	3	1	2	3	1	2	3	1	2	3	01	○	○	○				0D	○	○	○	○	○		02	○	○					0E	○	○	○	○			03	○	○					0F	○	○	○	○	○		04			○				11	○					○	05	○	○					12	○	○				○	06	○	○					13	○	○				○	07	○	○	○				18						○	08				○			19	○					○	09	○	○					1A	○	○				○	0A	○	○					1B	○	○				○	0B	○	○											○	0C			○	○									○	E31	●	●	◎		IPDU communication trouble Sub MCU communication trouble	There is no communication between IPDUs (P.C. boards) in inverter box.
Sub-code	A3-IPDU			Fan-IPDU			Sub-code	A3-IPDU			Fan-IPDU																																																																																																																																																																																															
	1	2	3	1	2	3		1	2	3	1	2	3																																																																																																																																																																																													
01	○	○	○				0D	○	○	○	○	○																																																																																																																																																																																														
02	○	○					0E	○	○	○	○																																																																																																																																																																																															
03	○	○					0F	○	○	○	○	○																																																																																																																																																																																														
04			○				11	○					○																																																																																																																																																																																													
05	○	○					12	○	○				○																																																																																																																																																																																													
06	○	○					13	○	○				○																																																																																																																																																																																													
07	○	○	○				18						○																																																																																																																																																																																													
08				○			19	○					○																																																																																																																																																																																													
09	○	○					1A	○	○				○																																																																																																																																																																																													
0A	○	○					1B	○	○				○																																																																																																																																																																																													
0B	○	○											○																																																																																																																																																																																													
0C			○	○									○																																																																																																																																																																																													
F04	—	F04	◎	◎	○	ALT	Outdoor discharge temperature sensor (TD1) trouble	Outdoor discharge temperature sensor (TD1) has been open/short-circuited.																																																																																																																																																																																																		
F05	—	F05	◎	◎	○	ALT	Outdoor discharge temperature sensor (TD2) trouble	Outdoor discharge temperature sensor (TD2) has been open/short-circuited.																																																																																																																																																																																																		
F06	01: TE1 02: TE2	F06	◎	◎	○	ALT	Outdoor heat exchanger liquid side temperature sensor (TE1, TE2) trouble	Outdoor heat exchanger liquid side temperature sensors (TE1, TE2) have been open/short-circuited.																																																																																																																																																																																																		
F07	01: TL1 02: TL2 03: TL3	F07	◎	◎	○	ALT	Outdoor liquid temperature sensor (TL1, TL2, TL3) trouble	Outdoor liquid temperature sensor (TL1, TL2, TL3) has been open/short-circuited.																																																																																																																																																																																																		
F08	—	F08	◎	◎	○	ALT	Outdoor outside air temperature sensor (TO) trouble	Outdoor outside air temperature sensor (TO) has been open/short-circuited.																																																																																																																																																																																																		

Check code		Display of receiving unit				Typical problem site	Description of problem
Outdoor 7-segment display		TCC-LINK central control or main remote control display	Indicator light block				
	Sub-code			Operation Ⓛ	Timer ⌚	Ready ⊗	Flash
F09	01: TG1 02: TG2	F09	⊗	⊗	○	ALT	Outdoor heat exchanger gas side temperature sensors (TG1, TG2) have been open/-short circuited.
F12	01: TS1 03: TS3	F12	⊗	⊗	○	ALT	Outdoor suction temperature sensor (TS1,TS3) trouble
F15	–	F15	⊗	⊗	○	ALT	Outdoor temperature sensor (TE1,TL1) wiring trouble
F16	–	F16	⊗	⊗	○	ALT	Outdoor pressure sensor (Pd, Ps) wiring trouble
F23	–	F23	⊗	⊗	○	ALT	Low pressure sensor (Ps) trouble
F24	–	F24	⊗	⊗	○	ALT	High pressure sensor (Pd) trouble
F31	–	F31	⊗	⊗	○	SIM	Outdoor EEPROM trouble
H05	–	H05	●	⊗	●		Outdoor discharge temperature sensor (TD1) wiring trouble
H06	–	H06	●	⊗	●		Activation of low-pressure protectio
H07	–	H07	●	⊗	●		Low oil level protection
H08	01: TK1 sensor trouble 02: TK2 sensor trouble 03: TK3 sensor trouble 04: TK4 sensor trouble 05: TK5 sensor trouble	H08	●	⊗	●		Trouble in temperature sensor for oil level detection (TK1-TK5)
H15	–	H15	●	⊗	●		Outdoor discharge temperature sensor (TD2) wiring trouble
H16	01: TK1 sensor trouble 02: TK2 sensor trouble 03: TK3 sensor trouble 04: TK4 sensor trouble 05: TK5 sensor trouble	H16	●	⊗	●		Oil level detection circuit trouble
H25	–	H25	●	⊗	●		Outdoor discharge temperature sensor (TD3) wiring trouble
L04	–	L04	⊗	○	⊗	SIM	Duplicated outdoor refrigerant line address
L06	Number of priority indoor units (check code L05 or L06 depending on individual unit)	L05	⊗	●	⊗	SIM	Duplicated priority indoor unit (as displayed on priority indoor unit)
		L06	⊗	●	⊗	SIM	Duplicated priority indoor unit (as displayed on indoor unit other than priority indoor unit)
L08	–	(L08)	⊗	●	⊗	SIM	Indoor group address not set
L10	–	L10	⊗	○	⊗	SIM	Outdoor capacity not set
L17	–	L17	⊗	○	⊗	SIM	Outdoor model incompatibility trouble
L23	–	L23	⊗	○	⊗	SIM	SW setting mistake
L28	–	L28	⊗	○	⊗	SIM	Too many outdoor units connected

Check code				Display of receiving unit				Typical problem site	Description of problem									
Outdoor 7-segment display				TCC-LINK central control or main remote control display	Indicator light block													
Sub-code					Operation ⏻	Timer ⌚	Ready ⊗			Flash								
L29	Sub-code	A3-IPDU		Fan-IPDU		Sub-code	A3-IPDU		Fan-IPDU		L29	⊙ ○ ⊙	SIM	Trouble in number IPDUs	There are insufficient number of IPDUs (P.C. boards) in inverter box.			
	01	1	2	3	1	2	0D	1	2	3						1	2	
	02	○					0E											
	03	○	○				0F	○	○	○						○		
	04			○			11	○									○	
	05	○		○			12		○								○	
	06		○				13	○	○								○	
	07	○	○	○			18										○	○
	08				○		19	○									○	○
	09	○				○	1A		○								○	○
	0A		○			○	1B	○	○								○	○
	0B	○	○			○	Circle (○): Faulty IPDU											
	0C			○														
L30	Detected indoor unit No.				(L30)	⊙	○	⊙	SIM	Indoor external trouble input (interlock)	Indoor unit has been shut down for external trouble input in one refrigerant line (detected by indoor unit).							
P03	-				P03	⊙	●	⊙	ALT	Outdoor discharge (TD1) temperature trouble	Outdoor discharge temperature sensor (TD1) has detected abnormally high temperature.							
P05	00: Open phase detected				P05	⊙	●	⊙	ALT	Open phase/power failure	Open phase is detected when power is turned on. Inverter DC voltage is too high (overvoltage) or too low (undervoltage).							
	01: Compressor 1									Inverter DC voltage (Vdc) trouble								
	02: Compressor 2									MG-CTT trouble								
P07	01: Compressor 1				P07	⊙	●	⊙	ALT	Heat sink overheating trouble	Temperature sensor built into IPM (TH) detects overheating.							
	02: Compressor 2																	
P10	Indoor unit No. detected				(P10)	●	⊙	⊙	ALT	Indoor unit overflow	Indoor unit has been shutdown in one refrigerant line due to detection of overflow (detected by indoor unit).							
P13	-				P13	●	⊙	⊙	ALT	Outdoor liquid backflow detection trouble	State of refrigerant cycle circuit indicates liquid backflow operation.							
P15	01: TS condition				P15	⊙	●	⊙	ALT	Gas leak detection	Outdoor suction temperature sensor (TS1) detects sustained and repeated high temperatures that exceed standard value.							
02: TD condition																		
P17	-				P17	⊙	●	⊙	ALT	Outdoor discharge (TD2) temperature trouble	Outdoor discharge temperature sensor (TD2) detects abnormally high temperature.							
P18	-				P18	⊙	●	⊙	ALT	Outdoor discharge (TD3) temperature trouble	Outdoor discharge temperature sensor (TD3) detects abnormally high temperature.							
P19	Outdoor unit No. detected				P19	⊙	●	⊙	ALT	4-way valve reversing trouble	Abnormality in refrigerating cycle is detected during heating operation.							
P20	-				P20	⊙	●	⊙	ALT	Activation of high-pressure protection	High pressure (Pd) sensor detects high pressure that exceeds standard value.							

MG-CTT: Magnet contactor

(Check code detected by IPDU featuring in SMMS-e and SMMS-i outdoor unit)

Check code		Display of receiving unit				Typical problem site	Description of problem	
Outdoor 7-segment display		TCC-LINK central control or main remote control display	Indicator light block					
Sub-code			Operation	Timer	Ready	Flash		
F13	01: Compressor 1 02: Compressor 2 03: Compressor 3	F13	⊙	⊙	○	ALT	Trouble in temperature sensor built into indoor IPM (TH)	Temperature sensor built into indoor IPM (TH) has been open/short-circuited.
H01	01: Compressor 1 02: Compressor 2 03: Compressor 3	H01	●	⊙	●		Compressor breakdown	Inverter current (Idc) detection circuit detects overcurrent.
H02	01: Compressor 1 02: Compressor 2 03: Compressor 3	H02	●	⊙	●		Compressor trouble (lockup)	Compressor lockup is detected
H03	01: Compressor 1 02: Compressor 2 03: Compressor 3	H03	●	⊙	●		Current detection circuit trouble	Abnormal current is detected while inverter compressor is turned off.
P04	01: Compressor 1 02: Compressor 2 03: Compressor 3	P04	⊙	●	⊙	ALT	Activation of high-pressure SW	High-pressure SW is activated.
P07	01: Compressor 1 02: Compressor 2 03: Compressor 3	P07	⊙	●	⊙	ALT	Heat sink overheating trouble	Temperature sensor built into IPM (TH) detects overheating or has been short-circuited.
P22	#0:Element short circuit #1:Position detection circuit trouble #3:Motor lock trouble #4:Motor current trouble #C:TH Sensor temperature trouble #D:TH Sensor short circuit/release trouble #E:Vdc voltage trouble *Put in Fan IPDU No. in [#] mark	P22	⊙	●	⊙	ALT	Outdoor fan IPDU trouble	Outdoor fan IPDU detects trouble.
P26	01: Compressor 1 02: Compressor 2 03: Compressor 3	P26	⊙	●	⊙	ALT	Activation of IPM short-circuit protection	Short-circuit protection for compressor motor driver circuit components is activated (momentary overcurrent).
P29	01: Compressor 1 02: Compressor 2 03: Compressor 3	P29	⊙	●	⊙	ALT	Compressor position detection circuit trouble	Compressor motor position detection trouble is detected.

Note: The above check codes are examples only, and different check codes may be displayed depending on the outdoor unit configuration

10-3. Troubleshooting Based on Information Displayed on Remote Control

Using main remote control (RBC-AMT32UL)

(1) Checking and testing

When a fault occurs to an air conditioner, a check code and indoor unit No. are displayed on the display window of the remote control.

Check codes are only displayed while the air conditioner is in operation.

If the display has already disappeared, access trouble history by following the procedure described below.

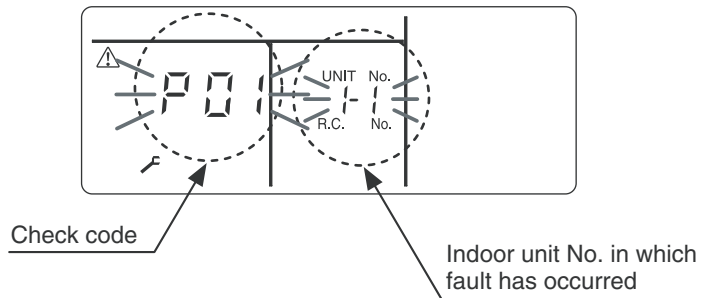

(2) Trouble history

The trouble history access procedure is described below (up to four troubles stored in memory).

Trouble history can be accessed regardless of

whether the air conditioner is in operation or shut down.

<Procedure> To be performed when system at rest

- 1 Invoke the **SERVICE CHECK** mode by pushing the **TEST** + **SET** buttons simultaneously and holding for at least 4 seconds.

The letters "SERVICE CHECK" light up, and the check code "01" is displayed, indicating the trouble history. This is accompanied by the indoor unit No. to which the trouble history is related and a check code.

- 2 To check other trouble history items, push the **TEMP.** button another check code.

Check code "01" Check code "04" (oldest)
Note: Error contains four items.

- 3 When the **TEST** button is pushed, normal display is

restored.

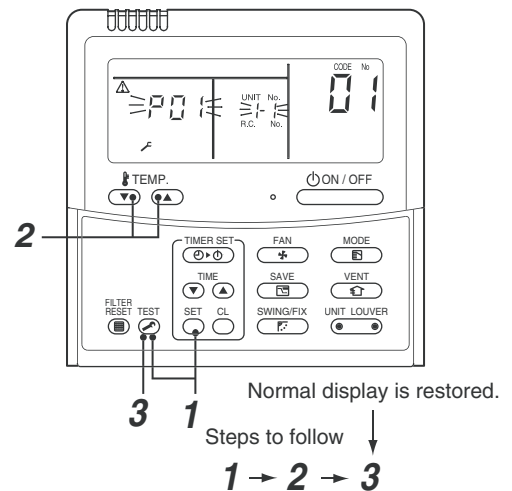

REQUIREMENT

Do not pu button as it would erase the whole trouble history of the indoor unit.

How to read displayed information

<segment display symbols>
0 1 2 3 4 5 6 7 8 9 A b C d E F H J L P

<Corresponding alphanumerical letters>

0 1 2 3 4 5 6 7 8 9 A b C d E F H J L P



Using indoor unit indicators (receiving unit light block) (wireless type)

To identify the check code, check the 7-segment display on the header unit. To check for check codes not displayed on the 7-segment display, consult the “List of Check Codes (Indoor Unit)” in “10-2. Troubleshooting Method”.

● : Goes off ○ : Lighting ☀ : Blinking (0.5 seconds)

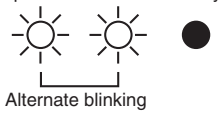
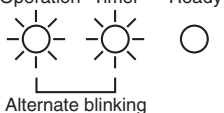

Light block	Check code	Cause of fault		
Operation ● Timer ● Ready ● All lights out	–	Power turned off or trouble in wiring between receiving and indoor units		
Operation ☀ Timer ● Ready ● Blinking	E01	Faulty reception	Receiving unit Trouble or poor contact in wiring between receiving and indoor units	
	E02	Faulty transmission		
	E03	Loss of communication		
	E08	Duplicated indoor unit No. (address)		Setting trouble
	E09	Duplicated master remote control		
	E10	Indoor unit inter-MCU communication trouble		
	E12	Automatic address starting trouble		
	E18	Trouble or poor contact in wiring between indoor units, indoor power turned off		
Operation ● Timer ● Ready ☀ Blinking	E04	Trouble or poor contact in wiring between indoor and outdoor units (loss of indoor-outdoor communication)		
	E06	Faulty reception in indoor-outdoor communication (Signal lack of indoor unit)		
	E07	Faulty transmission in indoor-outdoor communication		
	E15	Indoor unit not found during automatic address setting		
	E16	Too many indoor units connected/overloading		
	E19	Trouble in number of outdoor header units		
	E20	Detection of refrigerant piping communication trouble during automatic address setting		
	E23	Faulty transmission in outdoor-outdoor communication		
	E25	Duplicated follower outdoor address		
	E26	Faulty reception in outdoor-outdoor communication, Signal lack of outdoor unit		
	E28	Outdoor follower unit trouble		
	E31	IPDU communication trouble, sub MCU communication trouble		
	Operation ● Timer ☀ Ready ☀ Alternate blinking	P01	Indoor AC fan trouble	
P13		Outdoor liquid backflow detection trouble		
Operation ☀ Timer ● Ready ☀ Alternate blinking	P03	Outdoor discharge (TD1) temperature trouble		
	P04	Activation of outdoor high-pressure SW		
	P05	Open phase/power failure Inverter DC voltage (Vdc) trouble MG-CTT trouble		
	P07	Outdoor heat sink overheating trouble - Poor cooling of electrical component (IPM) of outdoor unit		
	P15	Gas leak detection - insufficient refrigerant charging		
	P17	Outdoor discharge (TD2) temperature trouble		
	P18	Outdoor discharge (TD3) temperature trouble		
	P19	Outdoor 4-way valve reversing trouble		
	P20	Activation of high-pressure protection		
	P22	Outdoor fan IPDU trouble		
	P26	Outdoor IPM short-circuit trouble		
	P29	Compressor position detection circuit trouble		
	P31	Shutdown of other indoor unit in group due to fault (group follower unit trouble)		

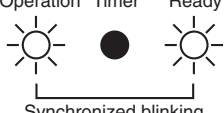
MG-CTT: Magnet contactor

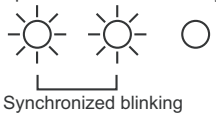
Light block	Check code	Cause of fault	
Operation Timer Ready  Alternate blinking	F01	Heat exchanger temperature sensor (TCJ) trouble	Indoor unit temperature sensor troubles
	F02	Heat exchanger temperature sensor (TC2) trouble	
	F03	Heat exchanger temperature sensor (TC1) trouble	
	F10	Ambient temperature sensor (TA/TSA) trouble	
	F11	Discharge temperature sensor (TF) trouble	
Operation Timer Ready  Alternate blinking	F04	Discharge temperature sensor (TD1) trouble	Outdoor unit temperature sensor troubles
	F05	Discharge temperature sensor (TD2) trouble	
	F06	Heat exchanger temperature sensor (TE1, TE2) trouble	
	F07	Liquid temperature sensor (TL1, TL2, TL3) trouble	
	F08	Outside air temperature sensor (TO) trouble	
	F12	Suction temperature sensor (TS1, TS3) trouble	
	F13	Heat sink sensor (TH) trouble	
	F15	Wiring trouble in heat exchanger sensor (TE1) and liquid temperature sensor (TL1) Outdoor unit temperature sensor wiring/installation trouble	Outdoor unit pressure sensor troubles
	F16	Wiring trouble in outdoor high pressure sensor (Pd) and low pressure sensor (Ps) Outdoor pressure sensor wiring trouble	
	F23	Low pressure sensor (Ps) trouble	
	F24	High pressure sensor (Pd) trouble	
	F29	Fault in indoor EEPROM	
Operation Timer Ready  Blinking	H01	Compressor breakdown	Outdoor unit compressor or A-3-IPDU related troubles
	H02	Compressor lockup	
	H03	Current detection circuit trouble	
	H05	Wiring/installation trouble or detachment of outdoor discharge temperature sensor (TD1)	Protective shutdown of outdoor unit
	H06	Abnormal drop in low-pressure sensor (Ps) reading	
	H07	Abnormal drop in oil level	
	H08	Trouble in temperature sensor for oil level detection circuit (TK1, TK2, TK3, TK4 or TK5)	
	H15	Wiring/installation trouble or detachment of outdoor discharge temperature sensor (TD2)	
	H16	Oil level detection circuit trouble - Trouble in outdoor unit TK1, TK2, TK3, TK4 or TK5 circuit	
	H25	Wiring/installation trouble or detachment of outdoor discharge temperature sensor (TD3)	
Operation Timer Ready  Synchronized blinking	L02	Outdoor unit model unmatched trouble	
	L03	Duplicated indoor group header unit	
	L05	Duplicated priority indoor unit (as displayed on priority indoor unit)	
	L06	Duplicated priority indoor unit (as displayed on indoor unit other than priority indoor unit)	
	L07	Connection of group control cable to stand-alone indoor unit	
	L08	Indoor group address not set	
Operation Timer Ready  Synchronized blinking	L09	Indoor capacity not set	
	L04	Duplicated outdoor refrigerant line address	
	L10	Outdoor capacity not set	
	L20	Duplicated central control address	
	L23	SW setting mistake	
	L24	Flow selector unit(s) setting trouble	
	L28	Too many outdoor units connected	
	L29	Trouble in number of IPDUs	
L30	Indoor external interlock trouble		

Light block	Check code	Cause of fault
<p>Operation Timer Ready</p>  <p>Synchronized blinking</p>	F31	Outdoor EEPROM trouble

Other (indications not involving check code)

Light block	Check code	Cause of fault
<p>Operation Timer Ready</p>  <p>Synchronized blinking</p>	-	Test run in progress
<p>Operation Timer Ready</p>  <p>Alternate blinking</p>	-	Setting incompatibility (automatic cooling/heating setting for model incapable of it and heating setting for cooling-only model)

10-4. Check Codes Displayed on Remote Control and SMMS-e and SMMS-i Outdoor Unit (7-Segment Display on I/F Board) and Locations to Be Checked

For other types of outdoor units, refer to their own service manuals.

Main remote control	Check code		Location of detection	Description	System status	Trouble detection condition(s)	Check items (locations)
	Outdoor 7-segment display	Sub-code					
E01	—	—	Remote control	Indoor-remote control communication trouble (detected at remote control end)	Stop of corresponding unit	Communication between indoor P.C. board and remote control is disrupted.	<ul style="list-style-type: none"> • Check remote control inter-unit tie cable (A/B). • Check for broken wire or connector bad contact. • Check indoor power supply. • Check for defect in indoor P.C. board. • Check remote control address settings (when two remote controls are in use). • Check remote control P.C. board.
E02	—	—	Remote control	Remote control transmission trouble	Stop of corresponding unit	Signal cannot be transmitted from remote control to indoor unit.	<ul style="list-style-type: none"> • Check internal transmission circuit of remote control. --- Replace remote control as necessary.
E03	—	—	Indoor unit	Indoor-remote control communication trouble (detected at indoor end)	Stop of corresponding unit	There is no communication from remote control (including wireless) or network adaptor.	<ul style="list-style-type: none"> • Check remote control and network adaptor wiring.
E04	—	—	Indoor unit	Indoor-outdoor communication circuit trouble (detected at indoor end)	Stop of corresponding unit	Indoor unit is not receiving signal from outdoor unit.	<ul style="list-style-type: none"> • Check order in which power was turned on for indoor and outdoor units. • Check indoor address setting. • Check indoor-outdoor tie cable. • Check outdoor terminating resistor setting (SW30, Bit 2).
E06	E06	No. of indoor units from which signal is received normally	I/F	Signal lack of indoor unit	All stop	Indoor unit initially communicating normally fails to return signal for specified length of time.	<ul style="list-style-type: none"> • Check power supply to indoor unit. (Is power turned on?) • Check connection of indoor-outdoor communication cable. • Check connection of communication connectors on indoor P.C. board. • Check connection of communication connectors on outdoor P.C. board. • Check for defect in indoor P.C. board. • Check for defect in outdoor P.C. board (I/F).
—	E07	—	I/F	Indoor-outdoor communication circuit trouble (detected at outdoor end)	All stop	Signal cannot be transmitted from outdoor to indoor units for 30 seconds continuously.	<ul style="list-style-type: none"> • Check outdoor terminating resistor setting (SW30, Bit 2). • Check connection of indoor-outdoor communication circuit.
E08	E08	Duplicated indoor address	Indoor unit I/F	Duplicated indoor address	All stop	More than one indoor unit are assigned same address.	<ul style="list-style-type: none"> • Check indoor addresses. • Check for any change made to remote control connection (group/individual) since indoor address setting.
E09	—	—	Remote control	Duplicated master remote control	Stop of corresponding unit	In two remote control configuration (including wireless), both controls are set up as master. (Header indoor unit is shut down with alarm, while follower indoor units continue operating.)	<ul style="list-style-type: none"> • Check remote control settings. • Check remote control P.C. boards.
E10	—	—	Indoor unit	Indoor inter-MCU communication trouble	Stop of corresponding unit	Communication cannot be established/maintained upon turning on of power or during communication.	<ul style="list-style-type: none"> • Check for defect in indoor P.C. board
E12	E12	01: Indoor-outdoor communication 02: Outdoor-outdoor communication	I/F	Automatic address starting trouble	All stop	<ul style="list-style-type: none"> • Indoor automatic address setting is started while automatic address setting for equipment in other refrigerant line is in progress. • Outdoor automatic address setting is started while automatic address setting for indoor units is in progress. 	<ul style="list-style-type: none"> • Perform automatic address setting again after disconnecting communication cable to that refrigerant line.
E15	E15	—	I/F	Indoor unit not found during automatic address setting	All stop	Indoor unit cannot be detected after indoor automatic address setting is started.	<ul style="list-style-type: none"> • Check connection of indoor-outdoor communication line. • Check for trouble in indoor power supply system. • Check for noise from other devices. • Check for power failure. • Check for defect in indoor P.C. board.

Check code		Location of detection	Description	System status	Trouble detection condition(s)	Check items (locations)	
Main remote control	Outdoor 7-segment display						
	Check code	Sub-code					
E16	E16	00: Overloading 01:- No. of units connected	I/F	Too many indoor units connected	All stop	<ul style="list-style-type: none"> • Combined capacity of indoor units exceeds 135% of combined capacity of outdoor units. <p>Note: If this code comes up after backup setting for outdoor unit failure is performed, perform "No overloading detected" setting. <"No overloading detected" setting method> Turn on SW09/Bit 2 on I/F P.C. board of outdoor header unit.</p> <ul style="list-style-type: none"> • More than 64 indoor units are connected. 	<ul style="list-style-type: none"> • Check capacities of indoor units connected. • Check combined HP capacities of indoor units. • Check HP capacity settings of outdoor units. • Check No. of indoor units connected. • Check for defect in outdoor P.C. board (I/F).
E18	—	—	Indoor unit	Trouble in communication between indoor header and follower units	Stop of corresponding unit	<p>Periodic communication between indoor header and follower units cannot be maintained.</p> <ul style="list-style-type: none"> • Check remote control wiring. • Check indoor power supply wiring. • Check P.C. boards of indoor units. 	
E19	E19	00: No header unit 02: Two or more header units	I/F	Trouble in number of outdoor header units	All stop	<ul style="list-style-type: none"> • There are more than one outdoor header units in one line. • There is no outdoor header unit in one line. 	<p>Outdoor header unit is outdoor unit to which indoor/outdoor tie cable (U1,U2) is connected.</p> <ul style="list-style-type: none"> • Check connection of indoor-outdoor communication line. • Check for defect in outdoor P.C. board (I/F).
E20	E20	01: Connection of outdoor unit from other line 02: Connection of indoor unit from other line	I/F	Connection to other line found during automatic address setting	All stop	<p>Equipment from other line is found to have been connected when indoor automatic address setting is in progress.</p>	<p>Disconnect inter-line tie cable in accordance with automatic address setting method explained in "Address setting" section.</p>
E23	E23	—	I/F	Outdoor/outdoor communication transmission trouble	All stop	<p>Signal cannot be transmitted to other outdoor units for at least 30 seconds continuously.</p>	<ul style="list-style-type: none"> • Check power supply to outdoor units. (Is power turned on?) • Check connection of tie cables between outdoor units for bad contact or broken wire. • Check communication connectors on outdoor P.C. boards. • Check for defect in outdoor P.C. board (I/F). • Check termination resistance setting for communication between outdoor units.
E25	E25	—	I/F	Duplicated follower outdoor address	All stop	<p>There is duplication in outdoor addresses set manually.</p>	<p>Note: Do not set outdoor addresses manually.</p>
E26	E26	Address of outdoor unit from which signal is not received normally	I/F	Signal lack of outdoor unit	All stop	<p>Outdoor unit initially communicating normally fails to return signal for specified length of time.</p>	<ul style="list-style-type: none"> • Backup setting is being used for outdoor units. • Check power supply to outdoor unit. (Is power turned on?) • Check connection of tie cables between outdoor units for bad contact or broken wire. • Check communication connectors on outdoor P.C. boards. • Check for defect in outdoor P.C. board (I/F).
E28	E28	Detected outdoor unit No.	I/F	Outdoor follower unit trouble	All stop	<p>Outdoor header unit receives trouble code from outdoor follower unit.</p>	<ul style="list-style-type: none"> • Check check code displayed on outdoor follower unit. <p><Convenient functions> If SW04 is pressed and held for at least 1 second while [E28] is displayed on the 7-segment display of outdoor header unit, the fan of the outdoor unit that has been shut down due to a trouble comes on. If SW04 and SW05 are pressed simultaneously, the fans of normal outdoor units come on. To stop the fan or fans, press SW05 on its own.</p>

Check code		Location of detection	Description	System status	Trouble detection condition(s)	Check items (locations)						
Main remote control	Outdoor 7-segment display											
Sub-code												
Sub-code	A3-IPDU						Fan-IPDU					
	1	2	3	1	2							
E31	E31	01	<input type="checkbox"/>	<input type="checkbox"/>	<input type="checkbox"/>	<input type="checkbox"/>	I/F	IPDU communication trouble	All stop	Communication is disrupted between IPDUs (P.C. boards) in inverter box.	<ul style="list-style-type: none"> • Check wiring and connectors involved in communication between IPDU-I/F P.C. board for bad contact or broken wire. • Check for defect in outdoor P.C. board (I/F, A3-IPDU or Fan IPDU). • Check for external noise. 	
		02	<input type="checkbox"/>	<input type="checkbox"/>	<input type="checkbox"/>	<input type="checkbox"/>						<input type="checkbox"/>
		03	<input type="checkbox"/>	<input type="checkbox"/>	<input type="checkbox"/>	<input type="checkbox"/>						<input type="checkbox"/>
		04	<input type="checkbox"/>	<input type="checkbox"/>	<input type="checkbox"/>	<input type="checkbox"/>						<input type="checkbox"/>
		05	<input type="checkbox"/>	<input type="checkbox"/>	<input type="checkbox"/>	<input type="checkbox"/>						<input type="checkbox"/>
		06	<input type="checkbox"/>	<input type="checkbox"/>	<input type="checkbox"/>	<input type="checkbox"/>						<input type="checkbox"/>
		07	<input type="checkbox"/>	<input type="checkbox"/>	<input type="checkbox"/>	<input type="checkbox"/>						<input type="checkbox"/>
		08	<input type="checkbox"/>	<input type="checkbox"/>	<input type="checkbox"/>	<input type="checkbox"/>						<input type="checkbox"/>
		09	<input type="checkbox"/>	<input type="checkbox"/>	<input type="checkbox"/>	<input type="checkbox"/>						<input type="checkbox"/>
		0A	<input type="checkbox"/>	<input type="checkbox"/>	<input type="checkbox"/>	<input type="checkbox"/>						<input type="checkbox"/>
		0B	<input type="checkbox"/>	<input type="checkbox"/>	<input type="checkbox"/>	<input type="checkbox"/>						<input type="checkbox"/>
		0C	<input type="checkbox"/>	<input type="checkbox"/>	<input type="checkbox"/>	<input type="checkbox"/>						<input type="checkbox"/>
		0D	<input type="checkbox"/>	<input type="checkbox"/>	<input type="checkbox"/>	<input type="checkbox"/>						<input type="checkbox"/>
		0E	<input type="checkbox"/>	<input type="checkbox"/>	<input type="checkbox"/>	<input type="checkbox"/>						<input type="checkbox"/>
		0F	<input type="checkbox"/>	<input type="checkbox"/>	<input type="checkbox"/>	<input type="checkbox"/>						<input type="checkbox"/>
		11	<input type="checkbox"/>	<input type="checkbox"/>	<input type="checkbox"/>	<input type="checkbox"/>						<input type="checkbox"/>
		12	<input type="checkbox"/>	<input type="checkbox"/>	<input type="checkbox"/>	<input type="checkbox"/>						<input type="checkbox"/>
13	<input type="checkbox"/>	<input type="checkbox"/>	<input type="checkbox"/>	<input type="checkbox"/>	<input type="checkbox"/>							
18	<input type="checkbox"/>	<input type="checkbox"/>	<input type="checkbox"/>	<input type="checkbox"/>	<input type="checkbox"/>							
19	<input type="checkbox"/>	<input type="checkbox"/>	<input type="checkbox"/>	<input type="checkbox"/>	<input type="checkbox"/>							
1A	<input type="checkbox"/>	<input type="checkbox"/>	<input type="checkbox"/>	<input type="checkbox"/>	<input type="checkbox"/>							
1B	<input type="checkbox"/>	<input type="checkbox"/>	<input type="checkbox"/>	<input type="checkbox"/>	<input type="checkbox"/>							
		80									<ul style="list-style-type: none"> • Operation of power supply reset (OFF for 60 seconds or more) • Outdoor I/F PC board trouble check 	
F01	—	—	Indoor unit	Indoor TCJ sensor trouble	Stop of corresponding unit	Sensor resistance is infinity or zero (open/short circuit).				<ul style="list-style-type: none"> • Check connection of TCJ sensor connector and wiring. • Check resistance characteristics of TCJ sensor. • Check for defect in indoor P.C. board. 		
F02	—	—	Indoor unit	Indoor TC2 sensor trouble	Stop of corresponding unit	Sensor resistance is infinity or zero (open/short circuit).				<ul style="list-style-type: none"> • Check connection of TC2 sensor connector and wiring. • Check resistance characteristics of TC2 sensor. • Check for defect in indoor P.C. board. 		
F03	—	—	Indoor unit	Indoor TC1 sensor trouble	Stop of corresponding unit	Sensor resistance is infinity or zero (open/short circuit).				<ul style="list-style-type: none"> • Check connection of TC1 sensor connector and wiring. • Check resistance characteristics of TC1 sensor. • Check for defect in indoor P.C. board. 		
F04	F04	—	I/F	TD1 sensor trouble	All stop	Sensor resistance is infinity or zero (open/short circuit).				<ul style="list-style-type: none"> • Check connection of TD1 sensor connector. • Check resistance characteristics of TD1 sensor. • Check for defect in outdoor P.C. board (I/F). 		
F05	F05	—	I/F	TD2 sensor trouble	All stop	Sensor resistance is infinity or zero (open/short circuit).				<ul style="list-style-type: none"> • Check connection of TD2 sensor connector. • Check resistance characteristics of TD2 sensor. • Check for defect in outdoor P.C. board (I/F). 		
F06	F06	01: TE1 sensor trouble 02: TE2 sensor trouble	I/F	TE1/TE2 sensor trouble	All stop	Sensor resistance is infinity or zero (open/short circuit).				<ul style="list-style-type: none"> • Check connection of TE1/TE2 sensor connectors. • Check resistance characteristics of TE1/TE2 sensors. • Check for defect in outdoor P.C. board (I/F). 		
F07	F07	01: TL1 sensor trouble 02: TL2 sensor trouble 03: TL3 sensor trouble	I/F	TL1 sensor trouble	All stop	Sensor resistance is infinity or zero (open/short circuit).				<ul style="list-style-type: none"> • Check connection of TL1/TL2/TL3 sensor connector. • Check resistance characteristics of TL1/TL2/TL3 sensor. • Check for defect in outdoor P.C. board (I/F). 		
F08	F08	—	I/F	TO sensor trouble	All stop	Sensor resistance is infinity or zero (open/short circuit).				<ul style="list-style-type: none"> • Check connection of TO sensor connector. • Check resistance characteristics of TO sensor. • Check for defect in outdoor P.C. board (I/F). 		
F09	F09	01: TG1 sensor trouble 02: TG2 sensor trouble	I/F	TG1/TG2 sensor trouble	All stop	Sensor resistance is infinity or zero (open/short circuit).				<ul style="list-style-type: none"> • Check connection of TG1/TG2 (open/short circuit). • Check resistance characteristics of TG1/TG2 sensors. • Check for defect in outdoor P.C. board (I/F). 		
F10	—	—	Indoor unit	Indoor TA sensor trouble	Stop of corresponding unit	Sensor resistance is infinity or zero (open/short circuit).				<ul style="list-style-type: none"> • Check connection of TA sensor connector and wiring. • Check resistance characteristics of TA sensor. • Check for defect in indoor P.C. board. 		

Check code			Location of detection	Description	System status	Trouble detection condition(s)	Check items (locations)
Main remote control	Outdoor 7-segment display						
	Check code	Sub-code					
F11	—	—	Indoor unit	Indoor TF sensor trouble	Stop of corresponding unit	Sensor resistance is infinity or zero (open/short circuit).	<ul style="list-style-type: none"> • Check connection of TF sensor connector and wiring. • Check resistance characteristics of TF sensor. • Check for defect in indoor P.C. board.
F12	F12	01: TS1 sensor trouble 03: TS3 sensor trouble	I/F	TS1/TS3 sensor trouble	All stop	Sensor resistance is infinity or zero (open/short circuit).	<ul style="list-style-type: none"> • Check connection of TS1/TS3 sensor connector. • Check resistance characteristics of TS1/TS3 sensor. • Check for defect.
F13	F13	01: Compressor 1 side 02: Compressor 2 side 03: Compressor 3 side	IPDU	TH sensor trouble	All stop	Sensor resistance is infinity or zero (open/short circuit).	<ul style="list-style-type: none"> • Defect in IPM built-in temperature sensor → Replace A3-IPDU P.C. board.
F15	F15	—	I/F	Outdoor temperature sensor wiring trouble (TE1, TL1)	All stop	During compressor operation in HEAT mode, TL1 continuously provides temperature reading higher than indicated by TL1 by at least specified margin for 3 minutes or more.	<ul style="list-style-type: none"> • Check installation of TE1 and TL1 sensors. • Check resistance characteristics of TE1 and TL1 sensors. • Check for outdoor P.C. board (I/F) trouble.
F16	F16	—	I/F	Outdoor pressure sensor wiring trouble (Pd, Ps)	All stop	Readings of high-pressure Pd sensor and lowpressure Ps sensor are switched. Output voltages of both sensors are zero.	<ul style="list-style-type: none"> • Check connection of highpressure Pd sensor connector. • Check connection of lowpressure Ps sensor connector. • Check for defect in pressure sensors Pd and Ps. • Check for trouble in outdoor P.C. board (I/F). • Check for deficiency in compressive output of compressor.
F23	F23	—	I/F	Ps sensor trouble	All stop	Output voltage of Ps sensor is zero.	<ul style="list-style-type: none"> • Check for connection trouble involving Ps sensor and Pd sensor connectors. • Check connection of Ps sensor connector. • Check for defect in Ps sensor. • Check for deficiency in compressive output of compressor. • Check for defect in 4-way valve. • Check for defect in outdoor P.C. board (I/F). • Check for defect in SV4 circuit.
F24	F24	—	I/F	Pd sensor trouble	All stop	Output voltage of Pd sensor is zero (sensor open-circuited). Pd > 4.15MPa despite compressor having been turned off.	<ul style="list-style-type: none"> • Check connection of Pd sensor connector. • Check for defect in Pd sensor. • Check for defect in outdoor P.C. board (I/F).
F29	—	—	Indoor unit	Other indoor trouble	Stop of corresponding unit	Indoor P.C. board does not operate normally.	<ul style="list-style-type: none"> • Check for defect in indoor P.C. board (faulty EEPROM)
F31	F31	—	I/F	Outdoor EEPROM trouble	All stop *1	Outdoor P.C. board (I/F) does not operate normally.	<ul style="list-style-type: none"> • Check power supply voltage. • Check power supply noise. • Check for defect in outdoor P.C. board (I/F).
H01	H01	01: Compressor 1 side 02: Compressor 2 side 03: Compressor 3 side	IPDU	Compressor breakdown	All stop	Inverter current detection circuit detects overcurrent and shuts system down.	<ul style="list-style-type: none"> • Check power supply voltage. (AC460V ± 10%). • Check for defect in compressor. • Check for possible cause of abnormal overloading. • Check for defect in outdoor P.C. board (A3-IPDU).
H02	H02	01: Compressor 1 side 02: Compressor 2 side 03: Compressor 3 side	IPDU	Compressor trouble (lockup) MG-CTT trouble	All stop	Overcurrent is detected several seconds after startup of inverter compressor.	<ul style="list-style-type: none"> • Check for defect in compressor. • Check power supply voltage. (AC460V ± 10%). • Check compressor system wiring, particularly for open phase. • Check connection of connectors/ terminals on A3-IPDU P.C. board. • Check conductivity of case heater. (Check for refrigerant problem inside compressor.) • Check for defect in outdoor P.C. board (A3-IPDU). • Check outdoor MG-CTT.
H03	H03	01: Compressor 1 side 02: Compressor 2 side 03: Compressor 3 side	IPDU	Current detection circuit trouble	All stop	Current flow of at least specified magnitude is detected despite inverter compressor having been shut turned off.	<ul style="list-style-type: none"> • Check current detection circuit wiring. • Check defect in outdoor P.C. board (A3-IPDU).

*1 Total shutdown in case of header unit
Continued operation in case of follower unit

MG-CTT: Magnet contactor

Check code			Location of detection	Description	System status	Trouble detection condition(s)	Check items (locations)
Main remote control	Outdoor 7-segment display						
	Check code	Sub-code					
H05	H05	—	I/F	TD1 sensor miswiring (incomplete insertion)	All stop	Discharge temperature of compressor 1 (TD1) does not increase despite compressor being in operation.	<ul style="list-style-type: none"> • Check installation of TD1 sensor. • Check connection of TD1 sensor connector and wiring. • Check resistance characteristics of TD1 sensor. • Check for defect in outdoor P.C. board (I/F).
H06	H06	—	I/F	Activation of low-pressure protection	All stop	Low-pressure Ps sensor detects operating pressure lower than 0.02MPa.	<ul style="list-style-type: none"> • Check service valves to confirm full opening (both gas and liquid sides). • Check outdoor PMVs for clogging (PMV1). • Check for defect in SV2 or SV4 circuits. • Check for defect in lowpressure Ps sensor. • Check indoor filter for clogging. • Check valve opening status of indoor PMV. • Check refrigerant piping for clogging. • Check operation of outdoor fan (during heating). • Check for insufficiency in refrigerant quantity.
H07	H07	—	I/F	Low oil level protection	All stop	Operating compressor detects continuous state of low oil level for about 2 hours.	<p><All outdoor units in corresponding line to be checked></p> <ul style="list-style-type: none"> • Check balance pipe service valve to confirm full opening. • Check connection and installation of TK1, TK2, TK3, TK4, and TK5 sensors. • Check resistance characteristics of TK1, TK2, TK3, TK4, and TK5 sensors. • Check for gas or oil leak in same line. • Check for refrigerant problem inside compressor casing. • Check SV3A, SV3B, SV3C, SV3D valves for defect. • Check oil return circuit of oil separator for clogging. • Check oil equalizing circuit for clogging.
H08	H08	01: TK1 sensor trouble 02: TK2 sensor trouble 03: TK3 sensor trouble 04: TK4 sensor trouble 05: TK5 sensor trouble	I/F	Trouble in temperature sensor for oil level detection	All stop	Sensor resistance is infinity or zero (open/short circuit).	<ul style="list-style-type: none"> • Check connection of TK1 sensor connector. • Check resistance characteristics of TK1 sensor. • Check for defect in outdoor P.C. board (I/F).
					All stop	Sensor resistance is infinity or zero (open/short circuit).	<ul style="list-style-type: none"> • Check connection of TK2 sensor connector. • Check resistance characteristics of TK2 sensor. • Check for defect in outdoor P.C. board (I/F).
					All stop	Sensor resistance is infinity or zero (open/short circuit).	<ul style="list-style-type: none"> • Check connection of TK3 sensor connector. • Check resistance characteristics of TK3 sensor. • Check for defect in outdoor P.C. board (I/F).
					All stop	Sensor resistance is infinity or zero (open/short circuit).	<ul style="list-style-type: none"> • Check connection of TK4 sensor connector. • Check resistance characteristics of TK4 sensor. • Check for defect in outdoor P.C. board (I/F).
					All stop	Sensor resistance is infinity or zero (open/short circuit).	<ul style="list-style-type: none"> • Check connection of TK5 sensor connector. • Check resistance characteristics of TK5 sensor. • Check for defect in outdoor P.C. board (I/F).
H15	H15	—	I/F	TD2 sensor miswiring (incomplete insertion)	All stop	Discharge temperature of (TD2) does not increase despite compressor 2 being in operation.	<ul style="list-style-type: none"> • Check installation of TD2 sensor. • Check connection of TD2 sensor connector and wiring. • Check resistance characteristics of TD2 sensor. • Check for defect in outdoor P.C. board (I/F).

Check code			Location of detection	Description	System status	Trouble detection condition(s)	Check items (locations)
Main remote control	Outdoor 7-segment display						
	Check code	Sub-code					
H16	H16	01: TK1 oil circuit trouble 02: TK2 oil circuit trouble 03: TK3 oil circuit trouble 04: TK4 oil circuit trouble 05: TK5 oil circuit trouble	I/F	Oil level detection circuit trouble	All stop	No temperature change is detected by TK1 despite compressor 1 having been started.	<ul style="list-style-type: none"> • Check for disconnection of TK1 sensor. • Check resistance characteristics of TK1 sensor. • Check for connection trouble involving TK1, TK2, TK3, TK4, and TK5 sensors • Check for clogging in oil equalizing circuit capillary and faulty operation in check valve. • Check for refrigerant entrapment inside compressor.
						No temperature change is detected by TK2 despite compressor 2 having been started.	<ul style="list-style-type: none"> • Check for disconnection of TK2 sensor. • Check resistance characteristics of TK2 sensor. • Check for connection trouble involving TK1, TK2, TK3, TK4, and TK5 sensors • Check for clogging in oil equalizing circuit capillary and faulty operation in check valve. • Check for refrigerant entrapment inside compressor.
						No temperature change is detected by TK3 despite compressor having been started.	<ul style="list-style-type: none"> • Check for disconnection of TK3 sensor. • Check resistance characteristics of TK3 sensor. • Check for connection trouble involving TK1, TK2, TK3, TK4, and TK5 sensors • Check for clogging in oil equalizing circuit capillary and faulty operation in check valve. • Check for refrigerant entrapment inside compressor.
						No temperature change is detected by TK4 despite compressor having been started.	<ul style="list-style-type: none"> • Check for disconnection of TK4 sensor. • Check resistance characteristics of TK4 sensor. • Check for connection trouble involving TK1, TK2, TK3, TK4, and TK5 sensors • Check for clogging in oil equalizing circuit capillary and faulty operation in check valve. • Check for refrigerant entrapment inside compressor.
						No temperature change is detected by TK5 despite compressor having been started.	<ul style="list-style-type: none"> • Check for disconnection of TK5 sensor. • Check resistance characteristics of TK5 sensor. • Check for connection trouble involving TK1, TK2, TK3, TK4, and TK5 sensors • Check for clogging in oil equalizing circuit capillary and faulty operation in check valve. • Check for refrigerant entrapment inside compressor.
H25	H25	—	I/F	TD3 sensor miswiring	All stop	Air discharge temperature (TD3) does not increase despite compressor 3 being in operation.	<ul style="list-style-type: none"> • Check installation of TD3 sensor. • Check connection of TD3 sensor connector and wiring. • Check resistance characteristics of TD3 sensor. • Check for defect in outdoor P.C. board (I/F).
L02	L02	—	Indoor unit	Outdoor units model disagreement trouble	Stop of corresponding unit	In case of different outdoor unit (Not corresponded to Air to Air Heat Exchanger type)	<ul style="list-style-type: none"> • Check outdoor unit model. (Check whether the outdoor unit corresponds to Air to Air Heat Exchanger type or not.)
L03	—	—	Indoor unit	Duplicated indoor header unit	Stop of corresponding unit	There are more than one header units in group.	<ul style="list-style-type: none"> • Check indoor addresses. • Check for any change made to remote control connection (group/individual) since indoor address setting.
L04	L04	—	I/F	Duplicated outdoor line address	All stop	There is duplication in line address setting for outdoor units belonging to different refrigerant piping systems.	<ul style="list-style-type: none"> • Check line addresses.
L05	—	—	I/F	Duplicated priority indoor unit (as displayed on priority indoor unit)	All stop	More than one indoor units have been set up as priority indoor unit.	<ul style="list-style-type: none"> • Check display on priority indoor unit.

Check code		Location of detection	Description	System status	Trouble detection condition(s)	Check items (locations)																																																																																																																																																
Main remote control	Outdoor 7-segment display																																																																																																																																																					
Check code	Sub-code																																																																																																																																																					
L06	L06	No. of priority indoor units	I/F	Duplicated priority indoor unit (as displayed on indoor unit other than priority indoor unit)	All stop	More than one indoor units have been set up as priority indoor unit.	• Check displays on priority indoor unit and outdoor unit.																																																																																																																																															
L07	—	—	Indoor unit	Connection of group control cable to standalone indoor unit	Stop of corresponding unit	There is at least one standalone indoor unit to which group control cable is connected.	• Check indoor addresses.																																																																																																																																															
L08	L08	—	Indoor unit	Indoor group / addresses not set	Stop of corresponding unit	Address setting has not been performed for indoor units.	• Check indoor addresses. Note: This code is displayed when power is turned on for the first time after installation.																																																																																																																																															
L09	—	—	Indoor unit	Indoor capacity not set	Stop of corresponding unit	Capacity setting has not been performed for indoor unit.	Set indoor capacity. (DN = 11)																																																																																																																																															
L10	L10	—	I/F	Outdoor capacity not set	All stop	Jumper wire provided on P.C. board for servicing I/F P.C. board has not been removed as required for given model.	Check model setting of P.C. board for servicing outdoor I/F P.C. board.																																																																																																																																															
L20	—	—	Network adaptor Indoor unit	Duplicated central control address	All stop	There is duplication in central control address setting.	• Check central control addresses. • Check network adaptor P.C. board .																																																																																																																																															
L23	—	—	I/F	SW setting mistake	All stop	Outdoor P.C. board (I/F) does not operate normally.	• Check switch setting of Bit 3 and 4 of SW17 in outdoor P.C. board (I/F).																																																																																																																																															
L28	L28	—	I/F	Too many outdoor units connected	All stop	There are more than three outdoor units.	• Check No. of outdoor units connected (Only up to 3 units per system allowed). • Check communication lines between outdoor units. • Check for defect in outdoor P.C. board (I/F).																																																																																																																																															
L29	L29	<table border="1"> <thead> <tr> <th rowspan="2">Sub-code</th> <th colspan="3">A3-IPDU</th> <th colspan="2">Fan-IPDU</th> </tr> <tr> <th>1</th> <th>2</th> <th>3</th> <th>1</th> <th>2</th> </tr> </thead> <tbody> <tr><td>01</td><td>○</td><td></td><td></td><td></td><td></td></tr> <tr><td>02</td><td></td><td>○</td><td></td><td></td><td></td></tr> <tr><td>03</td><td>○</td><td>○</td><td></td><td></td><td></td></tr> <tr><td>04</td><td></td><td></td><td>○</td><td></td><td></td></tr> <tr><td>05</td><td>○</td><td></td><td>○</td><td></td><td></td></tr> <tr><td>06</td><td></td><td>○</td><td>○</td><td></td><td></td></tr> <tr><td>07</td><td>○</td><td>○</td><td>○</td><td></td><td></td></tr> <tr><td>08</td><td></td><td></td><td></td><td>○</td><td></td></tr> <tr><td>09</td><td>○</td><td></td><td></td><td>○</td><td></td></tr> <tr><td>0A</td><td></td><td>○</td><td></td><td>○</td><td></td></tr> <tr><td>0B</td><td>○</td><td>○</td><td></td><td>○</td><td></td></tr> <tr><td>0C</td><td></td><td></td><td>○</td><td>○</td><td></td></tr> <tr><td>0D</td><td>○</td><td></td><td>○</td><td>○</td><td></td></tr> <tr><td>0E</td><td></td><td>○</td><td>○</td><td>○</td><td></td></tr> <tr><td>0F</td><td>○</td><td>○</td><td>○</td><td>○</td><td></td></tr> <tr><td>11</td><td>○</td><td></td><td></td><td></td><td>○</td></tr> <tr><td>12</td><td></td><td>○</td><td></td><td></td><td>○</td></tr> <tr><td>13</td><td>○</td><td>○</td><td></td><td></td><td>○</td></tr> <tr><td>18</td><td></td><td></td><td></td><td>○</td><td>○</td></tr> <tr><td>19</td><td>○</td><td></td><td></td><td>○</td><td>○</td></tr> <tr><td>1A</td><td>○</td><td></td><td></td><td>○</td><td>○</td></tr> <tr><td>1B</td><td>○</td><td>○</td><td></td><td>○</td><td>○</td></tr> </tbody> </table> <p>Circle (O): Faulty IPDU</p>	Sub-code	A3-IPDU			Fan-IPDU		1	2	3	1	2	01	○					02		○				03	○	○				04			○			05	○		○			06		○	○			07	○	○	○			08				○		09	○			○		0A		○		○		0B	○	○		○		0C			○	○		0D	○		○	○		0E		○	○	○		0F	○	○	○	○		11	○				○	12		○			○	13	○	○			○	18				○	○	19	○			○	○	1A	○			○	○	1B	○	○		○	○	I/F	Trouble in No. of IPDUs	All stop	Insufficient number of IPDUs are detected when power is turned on.	• Check model setting of P.C. board for servicing outdoor I/F P.C. board. • Check connection of UART communication connector. • Check A3-IPDU, fan IPDU, and I/F P.C. board for defect.
Sub-code	A3-IPDU			Fan-IPDU																																																																																																																																																		
	1	2	3	1	2																																																																																																																																																	
01	○																																																																																																																																																					
02		○																																																																																																																																																				
03	○	○																																																																																																																																																				
04			○																																																																																																																																																			
05	○		○																																																																																																																																																			
06		○	○																																																																																																																																																			
07	○	○	○																																																																																																																																																			
08				○																																																																																																																																																		
09	○			○																																																																																																																																																		
0A		○		○																																																																																																																																																		
0B	○	○		○																																																																																																																																																		
0C			○	○																																																																																																																																																		
0D	○		○	○																																																																																																																																																		
0E		○	○	○																																																																																																																																																		
0F	○	○	○	○																																																																																																																																																		
11	○				○																																																																																																																																																	
12		○			○																																																																																																																																																	
13	○	○			○																																																																																																																																																	
18				○	○																																																																																																																																																	
19	○			○	○																																																																																																																																																	
1A	○			○	○																																																																																																																																																	
1B	○	○		○	○																																																																																																																																																	
L30	L30	Detected indoor address	Indoor unit	External interlock of indoor unit	Stop of corresponding unit	• Signal is present at external trouble input terminal (CN080) for 1 minute.	When external device is connected to CN080 connector: 1) Check for defect in external device. 2) Check for defect in indoor P.C. board. When external device is not connected to CN080 connector: 1) Check for defect in indoor P.C. board.																																																																																																																																															
—	L31	—	I/F	Extended IC trouble	Continued operation	There is part failure in P.C. board (I/F).	Check outdoor P.C. board (I/F).																																																																																																																																															
P01	—	—	Indoor unit	Indoor fan motor trouble	Stop of corresponding unit		• Check the lock of fan motor (AC fan). • Check wiring.																																																																																																																																															

Main remote control	Check code		Location of detection	Description	System status	Trouble detection condition(s)	Check items (locations)
	Outdoor 7-segment display						
	Check code	Sub-code					
P03	P03	—	I/F	Discharge temperature TD1 trouble	All stop	Discharge temperature (TD1) exceeds 239°F (115°C).	<ul style="list-style-type: none"> • Check outdoor service valves (gas side, liquid side) to confirm full opening. • Check outdoor PMVs (PMV1, 2, 3) for clogging. • Check resistance characteristics of TD1 sensor. • Check for insufficiency in refrigerant quantity. • Check for defect in 4-way valve. • Check for leakage of SV4 circuit. • Check SV4 circuit (wiring or installation trouble in SV41, SV42 or SV43).
P04	P04	01: Compressor 1 side 02: Compressor 2 side 03: Compressor 3 side	IPDU	Activation of high-pressure SW	All stop	High-pressure SW is activated.	<ul style="list-style-type: none"> • Check connection of highpressure SW connector. • Check for defect in Pd pressure sensor. • Check outdoor service valves (gas side, liquid side) to confirm full opening. • Check for defect in outdoor fan. • Check for defect in outdoor fan motor. • Check outdoor PMVs (PMV1, 2, 3) for clogging. • Check indoor/outdoor heat exchangers for clogging. • Check for short-circuiting of outdoor suction/discharge air flows. • Check SV2 circuit for clogging. • Check for defect in outdoor P.C. board (I/F). • Check for trouble in indoor fan system (possible cause of air flow reduction). • Check opening status of indoor PMV. • Check indoor-outdoor communication line for wiring trouble. • Check for faulty operation of check valve in discharge pipe convergent section. • Check gas balancing SV4 valve circuit. • Check SV5 valve circuit. • Check for refrigerant overcharging.
P05	P05	00: 01: Compressor 1 side 02: Compressor 2 side 03: Compressor 3 side	I/F	Detection of open phase/ phase sequence Inverter DC voltage (Vdc) trouble (compressor) MG-CTT trouble	All stop	<ul style="list-style-type: none"> • Open phase is detected when power is turned on. • Inverter DC voltage is too high (overvoltage) or too low (undervoltage). 	<ul style="list-style-type: none"> • Check for defect in outdoor P.C. board (I/F). • Check wiring of outdoor power supply.
P07	P07	01: Compressor 1 side 02: Compressor 2 side 03: Compressor 3 side	IPDU I/F	Heat sink overheating trouble	All stop	Temperature sensor built into IPM (TH) is overheated.	<ul style="list-style-type: none"> • Check power supply voltage. • Check outdoor fan system trouble. • Check heat sink cooling duct for clogging. • Check IPM and heat sink for thermal performance for faulty installation. (e.g. mounting screws and thermal conductivity) • Check for defect in A3-IPDU. (faulty IPM built-in temperature sensor (TH))
P13	P13	—	I/F	Outdoor liquid backflow detection trouble	All stop	<p><During cooling operation> When system is in cooling operation, high pressure is detected in follower unit that has been turned off.</p> <p><During heating operation> When system is in heating operation, outdoor PMV 1, 2, 3 continuously registers opening of 300p or less while under superheat control.</p>	<ul style="list-style-type: none"> • Check full-close operation of outdoor PMV (1, 2, 3). • Check for defect in Pd or Ps sensor. • Check gas balancing circuit (SV2) for clogging. • Check balance pipe. • Check SV3B circuit for clogging. • Check defect in outdoor P.C. board (I/F). • Check capillary of oil separator oil return circuit for clogging. • Check for leakage of check valve in discharge pipe convergent section.

MG-CTT: Magnet contactor

		Check code		Location of detection	Description	System status	Trouble detection condition(s)	Check items (locations)
Main remote control	Outdoor 7-segment display							
	Check code	Sub-code						
P15	P15	01: TS condition	I/F	Gas leakdetection (TS1 condition)	All stop	Protective shutdown due to sustained suction temperature at or above judgment criterion for at least 10 minutes is repeated four times or more. <TS trouble judgment criterion> In cooling operation: 140°F (60°C) In heating operation: 104°F (40°C)	<ul style="list-style-type: none"> • Check for insufficiency in refrigerant quantity. • Check outdoor service valves (gas side, liquid side) to confirm full opening. • Check PMVs (PMV1, 2, 3) for clogging. • Check resistance characteristics of TS1 sensor. • Check for defect in 4-way valve. • Check SV4 circuit for leakage 	
		02: TD condition	I/F	Gas leak detection (TD condition)	All stop	Protective shutdown due to sustained discharge temperature (TD1 or TD2) at or above 226.4°F (108°C) for at least 10 minutes is repeated four times or more.	<ul style="list-style-type: none"> • Check for insufficiency in refrigerant quantity. • Check PMVs (PMV 1, 2, 3) for clogging. • Check resistance characteristics of TD1 and TD2 sensors. • Check indoor filter for clogging. • Check piping for clogging. • Check SV4 circuit (for leakage or coil installation trouble). 	
P17	P17	—	I/F	Discharge temperature TD2 trouble	All stop	Discharge temperature (TD2) exceeds 239°F (115°C).	<ul style="list-style-type: none"> • Check outdoor service valves (gas side, liquid side) to confirm full opening. • Check outdoor PMVs (PMV1, 2, 3) for clogging. • Check resistance characteristics of TD2 sensor. • Check for defect in 4-way valve. • Check SV4 circuit for leakage. • Check SV4 circuit (for wiring or installation trouble involving SV41, SV42 and SV43). 	
P18	P18	—	I/F	Discharge temperature TD3 trouble	All stop	Discharge temperature (TD3) exceeds 239 °F (115 °C).	<ul style="list-style-type: none"> • Check outdoor service valves (gas side, liquid side) to confirm full opening. • Check outdoor PMVs (PMV1, 2, 4) for clogging. • Check resistance characteristics of TD3 sensor. • Check for defect in 4-way valve. • Check SV4 circuit for leakage. • Check SV4 circuit (for wiring or installation error involving SV41, SV42 and SV43). 	
P19	P19	Detected outdoor unit No.	I/F	4-way valve reversing trouble	All stop	Abnormal refrigerating cycle data is collected during heating operation.	<ul style="list-style-type: none"> • Check for defect in main body of 4-way valve. • Check for coil defect in 4-way valve and loose connection of its connector. • Check resistance characteristics of TS1 and TE1,TE2 sensors. • Check output voltage characteristics of Pd and Ps pressure sensors. • Check for wiring trouble involving TE1 and TL1 sensors. 	
P20	P20	—	I/F	Activation of high-pressure protection	All stop	<During cooling operation> Pd sensor detects pressure equal to or greater than 558.25 psi (3.85 MPa). <During heating operation> Pd sensor detects pressure equal to or greater than 522 psi (3.6 MPa).	<ul style="list-style-type: none"> • Check for defect in Pd pressure sensor. • Check service valves (gas side, liquid side) to confirm full opening. • Check for defect in outdoor fan. • Check for defect in outdoor fan motor. • Check outdoor PMV (PMV1, 2, 3) for clogging. • Check indoor/outdoor heat exchangers for clogging. • Check for short-circuiting of outdoor suction/ discharge air flows. • Check SV2 circuit for clogging. • Check for defect in outdoor P.C. board (I/F). • Check for defect in indoor fan system (possible cause of air flow reduction). • Check opening status of indoor PMV. • Check indoor-outdoor communication line for wiring trouble. • Check for faulty operation of check valve in discharge pipe convergent section. • Check gas balancing SV4 valve circuit. • Check SV5 valve circuit. • Check for refrigerant overcharging. 	

Check code		Location of detection	Description	System status	Trouble detection condition(s)	Check items (locations)	
Main remote control	Outdoor 7-segment display						
Check code	Sub-code						
P22	P22	#0:Element short circuit	IPDU Outdoor fan IPDU trouble *Put in Fan IPDU No. in [#] mark	All stop	(Sub code: #0) Fan IPDU over current protection circuit. Flow of current equal to or greater than the specified value is detected during startup of the fan.	<ul style="list-style-type: none"> • Check fan motor. • Check for defect in fan IPDU P.C. board. 	
		#1:Position detection circuit trouble		All stop	(Sub code: #1) Fan IPDU position detection circuit. Position detection is not going on normally.	<ul style="list-style-type: none"> • Check fan motor. • Check connection of fan motor connector. • Check for defect in fan IPDU P.C. board. 	
		#3:Motor lock trouble		All stop	(Sub code: #3) Gusty wind, an obstruction, or another external factor. Speed estimation is not going on normally.	<ul style="list-style-type: none"> • Check fan motor. • Check for defect in fan IPDU P.C. board. 	
		#4:Motor current trouble		All stop	(Sub code: #4) Fan IPDU over current protection circuit. Flow of current equal to or greater than the specified value is detected during operation of the fan.	<ul style="list-style-type: none"> • Check fan motor. • Check connection of fan motor connector. • Check for defect in fan IPDU P.C. board. 	
		#C:TH sensor temperature trouble		All stop	(Sub code: #C) Higher temperature than the specified value is detected during operation of the fan.	<ul style="list-style-type: none"> • Check fan motor. • Check for defect in fan IPDU P.C. board. 	
		#D:TH sensor short circuit/release trouble		All stop	(Sub code: #D) The resistance value of the sensor is infinite or zero (open or short circuit).	<ul style="list-style-type: none"> • Check for defect in fan IPDU P.C. board. 	
		#E:Vdc voltage trouble		All stop	(Sub code: #E) Fan IPDU DC voltage protection circuit. The DC voltage higher or lower than the specified value is detected.	<ul style="list-style-type: none"> • Check power voltage of the main power supply. • Check for defect in fan IPDU P.C. board. • Check connection of fan IPDU P.C. board. 	
P26	P26	01: Compressor 1 side 02: Compressor 2 side 03: Compressor 3 side	IPDU	IPM shortcircuit protection trouble	All stop	Overcurrent is momentarily detected during startup of compressor.	<ul style="list-style-type: none"> • Check connector connection and wiring on A3-IPDU P.C. board. • Check for defect in compressor (layer shortcircuit). • Check for defect in outdoor P.C. board (A3-IPDU).
P29	P29	01: Compressor 1 side 02: Compressor 2 side 03: Compressor 3 side	IPDU	Compressor position detection circuit trouble	All stop	Position detection is not going on normally.	<ul style="list-style-type: none"> • Check wiring and connector connection. • Check for compressor layer short-circuit. • Check for defect in A3-IPDU P.C. board.
P31	—	—	Indoor unit	Other indoor trouble (group follower unit trouble)	Stop of corresponding unit	There is trouble in other indoor unit in group, resulting in detection of E07/L07/L03/L08.	<ul style="list-style-type: none"> • Check indoor P.C. board.
C05	—	—	TCC-LINK	TCC-LINK central control device transmission trouble	Continued operation	Central control device is unable to transmit signal.	<ul style="list-style-type: none"> • Check for defect in central control device. • Check for defect in central control communication line. • Check termination resistance setting.
C06	—	—	TCC-LINK	TCC-LINK central control device reception trouble	Continued operation	Central control device is unable to transmit signal.	<ul style="list-style-type: none"> • Check for defect in central control device. • Check for defect in central control communication line. • Check terminator resistor setting. • Check power supply for devices at other end of central control communication line. • Check defect in P.C. boards of devices at other end of central control communication line.
C12	—	—	General-purpose device I/F	Batch alarm for general-purpose device control interface	Continued operation	Trouble signal is input to control interface for general-purpose devices.	<ul style="list-style-type: none"> • Check trouble input.
P30	Differs according to nature of alarm-causing trouble		TCC-LINK	Group control follower unit trouble	Continued operation	Trouble occurs in follower unit under group control. ([P30] is displayed on central remote control.)	<ul style="list-style-type: none"> • Check check code of unit that has generated alarm.
	(L20 displayed.)			Duplicated central control address	Continued operation	There is duplication in central control addresses.	<ul style="list-style-type: none"> • Check address settings.

10-5. Sensor Characteristics

Indoor Unit

Temperature sensor characteristics

Indoor TA and TF sensor

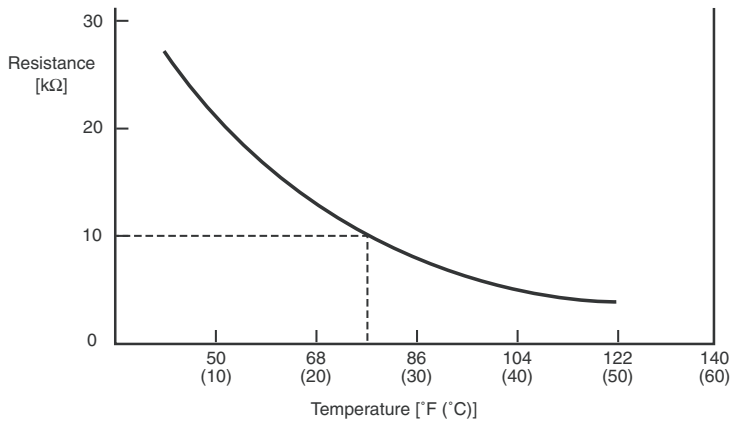

Temperature [°F (°C)]	Resistance [kΩ]
32 (0)	33.9
41 (5)	26.1
50 (10)	20.3
59 (15)	15.9
68 (20)	12.6
77 (25)	10.0
86 (30)	8.0
95 (35)	6.4
104 (40)	5.2
113 (45)	4.2
122 (50)	3.5
131 (55)	2.8
140 (60)	2.4

Indoor TC1 sensor

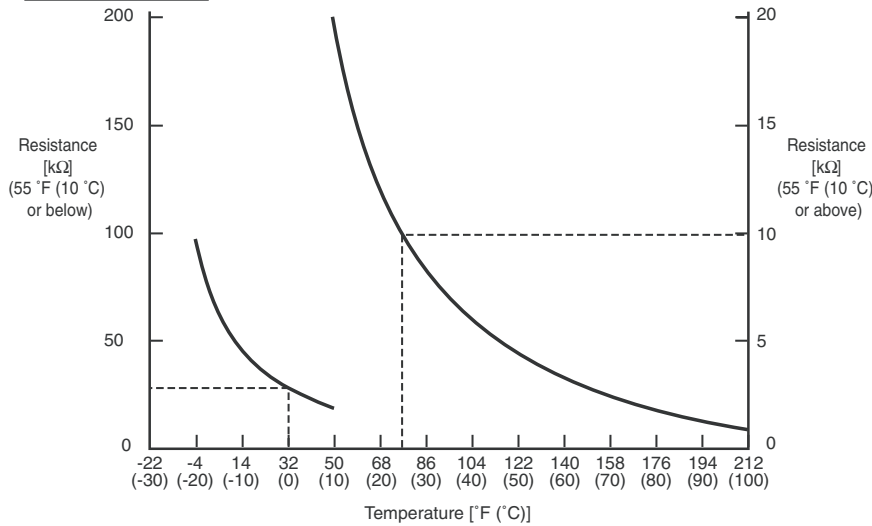

Temperature [°F (°C)]	Resistance [kΩ]
-4 (-20)	99.9
5 (-15)	74.1
14 (-10)	55.6
23 (-5)	42.2
32 (0)	32.8
41 (5)	25.4
50 (10)	19.8
59 (15)	15.6
68 (20)	12.4
77 (25)	10.0
86 (30)	8.1
95 (35)	6.5
104 (40)	5.3
113 (45)	4.4
122 (50)	3.6
131 (55)	3.0
140 (60)	2.5
149 (65)	2.1
158 (70)	1.8
167 (75)	1.5
176 (80)	1.3
185 (85)	1.1
194 (90)	1.0
203 (95)	0.8
212 (100)	0.7

Indoor TC2 and TCJ sensors

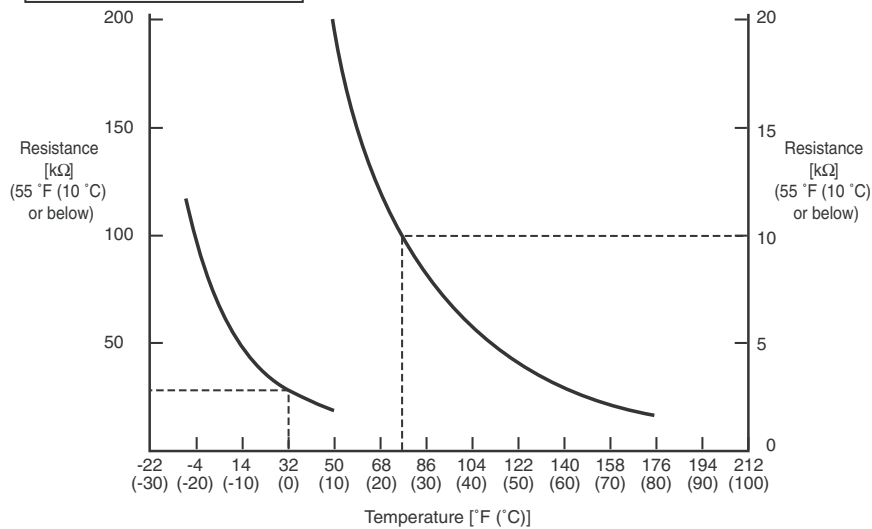

Temperature [°F (°C)]	Resistance [kΩ]
-4 (-20)	115.2
5 (-15)	84.2
14 (-10)	62.3
23 (-5)	46.6
32 (0)	35.2
41 (5)	26.9
50 (10)	20.7
59 (15)	16.1
68 (20)	12.6
77 (25)	10.0
86 (30)	8.0
95 (35)	6.4
104 (40)	5.2
113 (45)	4.2
122 (50)	3.5
131 (55)	2.8
140 (60)	2.4
149 (65)	2.0
158 (70)	1.6
167 (75)	1.4
176 (80)	1.2

1 Precautions for safety

Installing, starting up, and servicing air conditioning equipment can be hazardous due to system pressures, electrical components, and equipment location (roofs, elevated structures, etc.). Only trained, qualified installers and service mechanics should install, start up, and service this equipment. Untrained personnel can perform basic maintenance functions such as cleaning indoor unit air filter. All other operations should be performed by trained service personnel.

Before working on the equipment, observe precautions in the literature and on tags, stickers, and labels attached to the equipment.

Follow all safety codes. Wear safety glasses and work gloves. Use care in handling, rigging, and setting bulky equipment.

Read these instructions thoroughly and follow all warnings or cautions included in literature and attached to the unit. Consult local building codes and National Electrical Code (NEC) for special requirements. Recognize safety information. This is the safety alert symbol . When you see this symbol on the unit and in instructions or manuals, be alert to the potential for personal injury. Understand these signal words: DANGER, WARNING, and CAUTION. These words are used with the safety alert symbol.

DANGER identifies the most serious hazards which will result in severe personal injury or death. WARNING signifies hazards which could result in personal injury or death. CAUTION is used to identify unsafe practices which may result in minor personal injury or product and property damage. NOTE is used to highlight suggestions which will result in enhanced installation, reliability, or operation.

The manufacturer shall not assume any liability for the damage caused by not observing the description of this manual.

WARNING

- General**
 - Carefully read Owner's Manual before starting the air conditioner. There are many important things to keep in mind for daily operation.
 - Ask for installation to be performed by the dealer or a professional. Only a qualified installer is able to install an air conditioner. If a non-qualified person installs an air conditioner, it may result in problems such as fire, electric shock, injury, water leakage, noise and vibration.
 - Do not use any refrigerant different from the one specified for complement or replacement. Otherwise, abnormally high pressure may be generated in the refrigeration cycle, which may result in a failure or explosion of the product or an injury to your body.
 - Places where the operation sound of the outdoor unit may cause a disturbance. (Especially at the boundary line with a neighbor, install the air conditioner while considering the noise.)
- Installation**
 - Only a qualified installer or qualified service person is allowed to carry out the electrical work of the air conditioner. Under no circumstances must this work be done by an unqualified individual since failure to carry out the work properly may result in electric shocks and/or electrical leaks.
 - After the installation work has been completed, have the installer explain about the circuit breaker positions. In the event that trouble has occurred in the air conditioner, set the circuit breaker to the OFF position, and contact a service person.
 - If the unit is installed in a small room, take appropriate measures to prevent the refrigerant from exceeding the limit concentration even if it leaks. Consult the dealer from whom you purchased the air conditioner when you implement the measures. Accumulation of highly concentrated refrigerant may cause an oxygen deficiency accident.
 - Do not install the air conditioner in a location that may be subject to a risk of expire to a combustible gas. If a combustible gas leaks and becomes concentrated around the unit, a fire may occur.
 - If separately sold products are used, use TOSHIBA/Carrier specified products only. Using unspecified products may cause fire, electric shock, water leak or other failure.
 - Connect ground wire. (grounding work) Incomplete grounding may cause an electric shock.

Thank you very much for purchasing TOSHIBA/Carrier Air Conditioner.
Please read this owner's manual carefully before using your Air Conditioner.

- Be sure to obtain the "Owner's manual" from constructor (or dealer).

We would appreciate your understanding of the Owner's manual and we kindly ask for your long and continued use.

ADOPTION OF NEW REFRIGERANT

This Air Conditioner adopts a new refrigerant HFC (R410A) instead of the conventional refrigerant R22 in order to prevent destruction of the ozone layer.

This appliance can be used by children aged from 8 years and above and persons with reduced physical sensory or mental capabilities or lack of experience and knowledge if they have been given supervision or instruction concerning use of the appliance in a safe way and understand the hazards involved. Children shall not play with the appliance. Cleaning and user maintenance shall not be made by children without supervision.

Contents

1	Precautions for safety	1
2	Part names	3
3	Part names and functions of the remote control	3
4	Basic operation	5
5	Timer operation	6
6	Installation	6
7	Notes on operations and performance	7
8	Maintenance	7
9	Troubleshooting	8

Operation

- Before opening the intake grille of the indoor unit set the circuit breaker to the OFF position. Failure to set the circuit breaker to the OFF position may result in electric shocks through contact with the interior parts. Only a qualified installer or qualified service person is allowed to remove the intake grille of the indoor unit or service panel of the outdoor unit and do the work required.
- Inside the air conditioner are high-voltage areas and rotating parts. Due to the danger of electric shocks or of your fingers or physical objects becoming trapped in the rotating parts, do not remove the intake grille of the indoor unit or service panel of the outdoor unit. When work involving the removal of these parts is required, contact a qualified installer or a qualified service person.
- Do not move or repair any unit by yourself. Since there is high voltage inside the unit, you may get electric shock during removing the cover and main unit.
- Use of a stand more than 50 cm high to clean the filter of the indoor unit or to carry out other such jobs constitutes working at heights. Due to the danger of falling off the stand and injuring yourself while working at heights, this kind of work should not be done by unqualified individuals. When this kind of work must be carried out, do not do it yourself but ask a qualified installer or a qualified service person to do it for you.
- Do not touch the aluminum fin of the outdoor unit. You may injure yourself if you do so. If the fin must be touched, do not touch it yourself but contact a qualified installer or a qualified service person.
- Do not climb onto or place objects on top of the outdoor unit. You may fall or the objects may fall off of the outdoor unit and result in injury.
- Do not place any combustion appliance in a place where it is directly exposed to the wind of air conditioner, otherwise it may cause imperfect combustion.
- When the air conditioner is operated with a combustion appliance in the same place, ventilate the room adequately. Poor ventilation may cause oxygen shortage.
- When the air conditioner is used in a closed room, ventilate the room. Poor ventilation may cause oxygen shortage.
- Do not expose your body to cool air directly for a long time and do not cool yourself excessively. Doing so may result in deteriorated physical condition and ill health.
- Do not insert your finger or a stick into the air intake or outlet.
- Doing so may result injury as the fan is rotating at high speed inside the unit.
- Consult the shop where you purchased the air conditioner if air conditioning (cooling and heating) is not performed properly as a refrigerant leakage may be the cause. Confirm the repair details with a qualified service person when the repair includes additional charging of the refrigerant.
- Stop running the air conditioner and turn off the breaker before cleaning.
- Otherwise, injury may result as the fan is rotating at high speed inside the unit.

Repairs

- If there is any kind of trouble (such as when check code display has appeared, there is a smell of burning, abnormal sounds are heard, the air conditioner fails to cool or heat or water is leaking) has occurred in the air conditioner, do not touch the air conditioner yourself but set the circuit breaker to the OFF position, and contact a qualified service person. Take steps to ensure that the power will not be turned on (by marking "out of service" near the circuit breaker, for instance) until qualified service person arrives. Continuing to use the air conditioner in the trouble status may cause mechanical problems to escalate or result in electric shocks or other failure.
- If the fan grille is damaged, do not approach the outdoor unit but set the circuit breaker to the OFF position, and contact a qualified service person to have the repairs done. Do not set the circuit breaker to the ON position until the repairs are completed.
- If there is a danger of the indoor unit's falling, do not approach the indoor unit but set the circuit breaker to the OFF position, and contact a qualified installer or a qualified service person to refit the unit. Do not set the circuit breaker to the ON position until the unit has been refitted.
- If there is a danger of the outdoor unit's toppling over, do not approach the outdoor unit but set the circuit breaker to the OFF position, and contact a qualified installer or a qualified service person to have the improvements or refitting done. Do not set the circuit breaker to the ON position until the improvements or refitting is completed.
- Do not customize the unit. Doing so may result in fire, electric shock or other failure.

Relocation

- When the air conditioner is to be relocated, do not relocate it yourself but contact a qualified installer or a qualified service person. Failure to relocate the air conditioner properly may result in electric shocks and/or a fire.

CAUTION

Cautions about installation (Confirm the following cautions.)

- Certainly lay the drain hose for perfect draining. Bad drainage may cause flooding in the house and getting furniture wet.
- Use an exclusive power supply circuit for air conditioner at the rated voltage. An insufficient power supply capacity or inappropriate installation may cause fire.
- Confirm that the outdoor unit are fixed on the base. Otherwise, falling down of the units or other accidents may occur.

Cautions about operation

- Do not use this air conditioner for special purpose such as preserving food, precision instruments, art objects, breeding animals, car, vessel, etc.
- Do not operate the buttons with wet hands. Doing so may cause electric shock.
- If the air conditioner will not be used for a considerably long time, turn off the main switch or the circuit breaker, for safety.
- To make the air conditioner operate in its original performance, operate it within the range of the operating temperature specified in the instructions. Otherwise it may cause a malfunction, or water leak from the unit.
- Prevent any liquid from falling into the remote control. Do not spill juice, water or any kind of liquid.
- Do not wash the air conditioner. Doing so may result in electric shock.
- Check whether the installation base and other equipment have become deteriorated after being used for a long time. Leaving them such condition may result in the unit's falling down and causing injury.
- Do not leave flammable sprays or other flammable materials near the air conditioner, and do not spray flammable aerosol directly to the air conditioner. They may catch fire.
- Stop running the air conditioner and turn off the breaker before cleaning. Otherwise, injury may result as the fan is rotating at high speed inside the unit.
- Ask an authorized dealer or qualified service person for cleaning of the air conditioner. Cleaning the air conditioner in an improper manner may cause damage to plastic parts, insulation failure of electric parts, and result in a malfunction. In the worst case, it may result in water leakage, electric shock, smoke emission and fire.
- Do not put a water container such as a vase on the unit.
- Water intrusion into the unit may occur and it may cause deterioration of electric insulation and result in electric shock.

2 Part names

■ Outside Air Unit

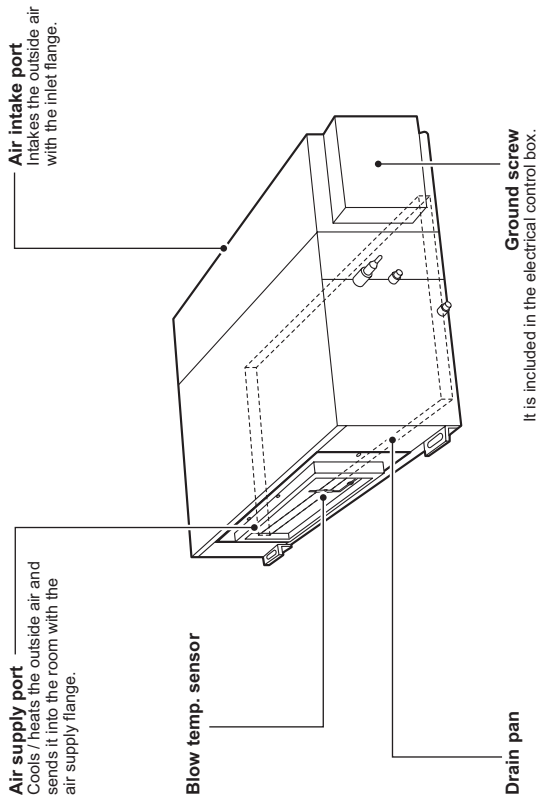

3 Part names and functions of the remote control

■ Display section

All indicators are displayed in the display example below.

Actually, only the selected options will be displayed.

- **SETTING** blinks on the display of the remote control the first time the power switch is turned on.
- The initial settings progress while **SETTING** is blinking. Start to use the remote control after **SETTING** has disappeared.

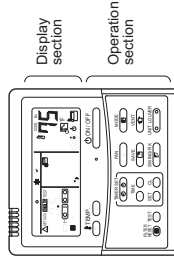

NOTE

The LCD may temporarily be blurred due to static electricity.

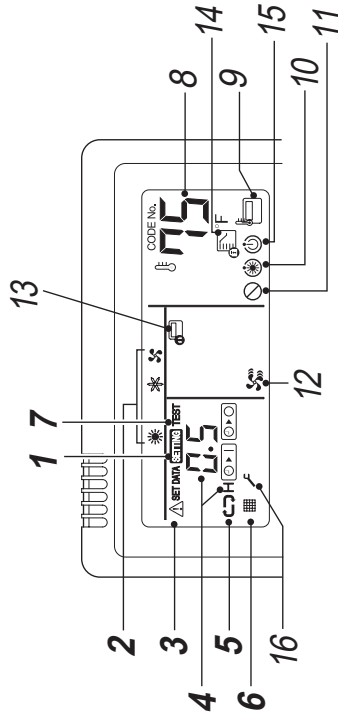

- 1 SETTING indicator**
Displayed when setting the timer or other functions.
- 2 Operation mode indicator**
Indicates the operation mode selected.
- 3 Check code indicator**
Displayed when the protective device activates or a problem occurs.
- 4 Time display**
Indicates time concerning the timer.
(Indicates a check code when a problem occurs)
- 5 Timer mode indicator**
Displays the timer mode.
- 6 Filter indicator**
Reminder to clean the air filter.
- 7 TEST run indicator**
Displayed during test run.

■ Operation section

Once the settings have been configured, all you need to do is push the **ON/OFF** button from then on.

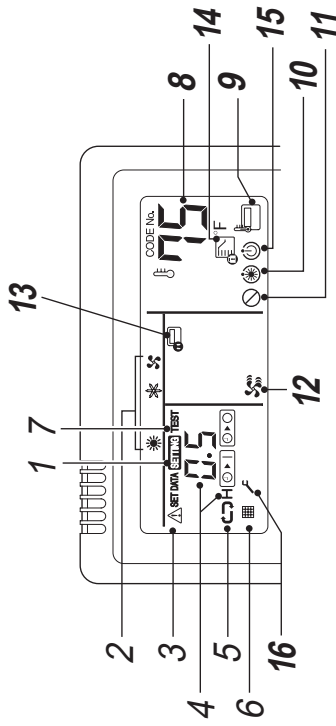

- 8 Set temperature display**
The selected set temperature is displayed.
- 9 Remote control sensor indicator**
Displayed when the remote control sensor is used.
- 10 Pre-heat indicator**
Displayed when the heating mode is energized or defrost cycle is initiated.
While this indication is displayed, the indoor fan stops or operate in fan mode.
- 11 No function indicator**
Displayed when the function requested is not available on that model.
- 12 Fan speed indicator**
Fan speed is fixed and the indicator is fixed to "High".
- 13 Central control indicator**
Displayed when the air conditioner is controlled centrally and used with central control devices such as the central remote control.
If the use of the remote control is prohibited by the central control, the indicator blinks when the ON/OFF, MODE, or TEMP. button on the remote control is pushed, and the buttons do not function. (Settings that can be configured on the remote control differ depending on the mode of the central control. For details, read the Owner's Manual of the central remote control.)
- 14 Operation mode controlled indicator**
Displayed when MODE button is pushed while operation mode is fixed to cool or heat by the air conditioner administrator.
- 15 Operation ready display**
This display appears on some models.
- 16 Service display**
Displayed while the protective device works or a problem occurs.

- 1 ON/OFF button (Fan speed select button)**
Only "High" is displayed.
 - 2 TIMER SET button (Timer set button)**
Use to setup the timer.
 - 3 TEST button (TEST button)**
Use only for service.
(During normal operation, do not use this button.)
 - 4 MODE button**
Use when a ventilator (commercially-available) is connected. Push the button to turn ON/OFF the ventilator. Turning ON/OFF the air-conditioner also turns ON/OFF the ventilator.
* No ventilator is connected if " " appears on the remote control display after pushing the **ON/OFF** button.
 - 5 FILTER RESET button (Filter reset button)**
Resets "FILTER" indication after cleaning.
 - 6 SAVE button (Power save operation)**
No function.
 - 7 SWANSEK button**
No function.
 - 8 Operation lamp**
Lights up during running.
Blinks when a problem occurs or the protective device activates.
 - 9 ON/OFF button**
Turns on the unit when pushed, and turns off when pushed again.
 - 10 MODE button (Operation mode select button)**
Selects desired operation mode.
 - 11 UNIT LOUVER button (Unit / Louver select button)**
UNIT button:
No function.
LOUVER button:
No function.
 - 12 TEMP. button**
Adjusts the set temperature.
Select the desired set point by pushing **TEMP.** **▲** or **▼** **TEMP.**
- OPTION:**
Remote control sensor
Normally the temperature sensor of the indoor unit senses the temperature. The temperature around the remote control can also be sensed. For details, contact your dealer.

4 Basic operation

When you use the air conditioner for the first time or change the settings, follow the procedures below.
From next time, pushing the **ON/OFF** button starts running of the air conditioner with the chosen settings.

■ Preparation

Turn on the power switch

- When turned on, the separation line appears and **SETTING** blinks on the remote control display.
- * The remote control will not work for about 1 minute after turning on the power. This is not a malfunction.**

■ REQUIREMENT

- Keep the power switch turned on during use.
- When you resume using the air conditioner after a long period of disuse, turn on the power switch at least 12 hours before starting running.

■ Operations

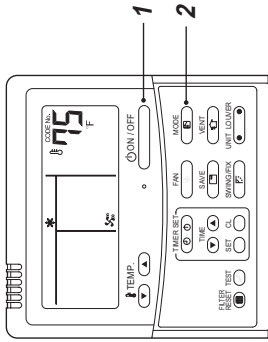

1 Push the **MODE button.**

The operation lamp lights up.

2 Push the **MODE button to select a operation mode.**

Each time you push the button, the operation mode and its icon change in the following order:

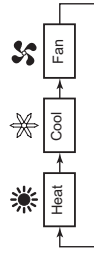

- Fan speed is fixed and the indicator is fixed to "High".

■ Operation mode and function

COOL : Cools the outside air and sends it into the room
HEAT : Heats the outside air and sends it into the room
FAN : Sends the outside air as it is

The air conditioner with the Outside Air Unit controls temperature of the supply air so that it is close to the setup temperature of the remote control.
 However temperature of the supply air may not be close to the setup temperature according to temperature of the outside air or the operation condition of the indoor units for air conditioning in one line.

■ REQUIREMENT

- The air conditioner with the Outside Air Unit cannot control the room temperature.
- For control of the room temperature, an indoor unit for air conditioning is required separately.

■ Use conditions

- In **COOL** mode, if temperature of the outside air is under the setup temp. +5.4°F, **FAN** status is automatically made. When temperature of the outside air is under 66 °F, **FAN** status is also made regardless of the setup temperature.
- In **HEAT** mode, if temperature of the outside air is over the setup temp. -5.4°F, **FAN** status is automatically made. When temperature of the outside air is over 59°F, **FAN** status is also made regardless of the setup temperature.

Case to use in **SMMS-e**

Outdoor Air Temperature °F

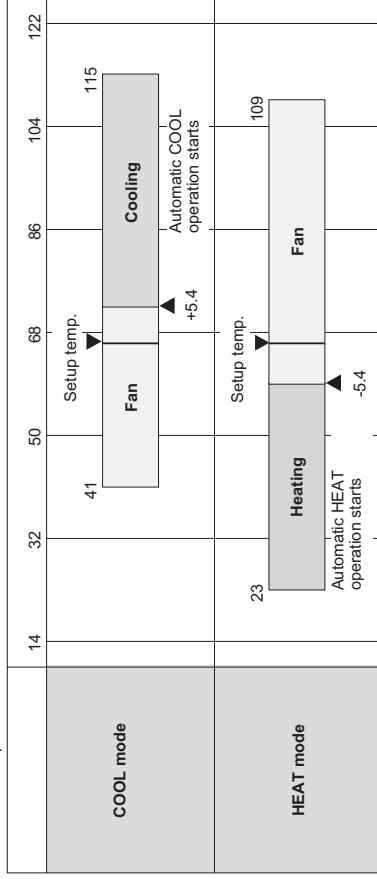

■ REQUIREMENT

- In "COOL" or "FAN" mode, if temperature of the outside air is under 41 °F, the operation stop automatically in order to protect the equipment.
 In this case, continue the operation by selecting "HEAT" mode.
- In "HEAT" mode, if temperature of the outside air is under 23 °F, the operation stops automatically in order to protect the equipment.
 When operating the air conditioner with the outside air temp. under 23 °F (minimum 5 °F), set temp. of the outside air to be taken in to 23 °F or upper using a duct heater (locally procured).
 For details, consult the dealer which you purchased the air conditioner.

5 Timer operation

Select a timer type from the following three: (Max. 168 hours)

- OFF timer** : Stops running after the specified period.
- Repeat-OFF timer** : Stops running after the specified period every time you use the air conditioner.
- On timer** : Starts running after the specified period.

Setting the timer

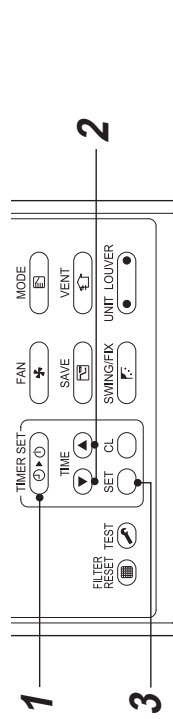

1 Push the **TIMER SET** button.

Each time you push the button, the timer mode and indication change in the following order:

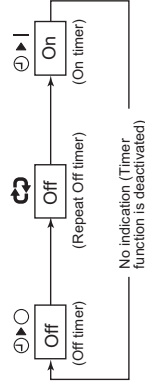

• 34 hours (*2)

1d indicates 1 day (24 hours).
10h indicates 10 hours.
(Total: 34 hours)



3 Push the **SET** button.

SETTING disappears, the time indication is displayed, and **▶** or **◀** or **▶** or **◀** display flashes.
(When using the ON timer, all indications other than the time and **▶** turn off.)

- **SETTING** and the time indicator blink.

2 Push the **TIME** buttons to set the period of time until the timer actions.

- The time setting increases in 0.5-hour (30-minute) increments each time you push **▶**. The setting increases in 1-hour increments if it is over 1d (24 hours). The maximum is 7d (168 hours).
- On the remote control, settings between 0.5h and 23.5h (*1) are displayed as is. If it is over 24 hours (*2), the days and hours appear.
- The time setting decreases in 0.5-hour (30-minute) decrements (0.5 hours to 23.5 hours) or 1-hour decrements (24 hours to 168 hours) each time you push **◀**.

Example of remote control display

- 23.5 hours (*1)



6 Installation

Location

- Avoid locations where inside the ceiling is used as a route for outside air.
- Avoid installing near machines emitting high frequency waves.
- Not suitable for chemical plants such as liquefied carbon dioxide refrigerant plants.
- Do not install the air conditioner in locations where iron or other metal dust is present. If iron or other metal dust adheres to or collects on the interior of the air conditioner, it may spontaneously combust and start a fire.
- A failure may occur in certain locations such as the following:
 - Areas with large amount of oil droplets (including machine oil) or vapors
 - Salty areas near oceans, etc.
 - Hot springs emitting sulfidizing gas, etc.
 - Heavily acidic or alkaline places.
- Special maintenance or parts are required for use in the above places. For details, contact the dealer where you purchased the product.
- Leave an enough space around the air intake and discharge of the outdoor unit so that the ventilation is not restricted.
- Avoid places where strong wind may blow against the air intake and discharge of the outdoor unit.
- Attach a snow stand, snow hood, etc. to the outdoor unit for use in snowfall areas. For details, contact the dealer where you purchased the product.
- Make sure drain water from the outdoor unit is emitted into places with good drainage.
- Make sure the long life prefilter and high-efficiency filter are installed in the filter chamber. If the long life prefilter and high-efficiency filter are not attached, heat exchangers etc. clogged with dust can result in water leakage. Attach the long life prefilter and high-efficiency filter because dust can also get into the area being air conditioned.
- Keep a distance of at least 39.4" between the air conditioner / remote control and a TV or radio. Failure to observe this precaution may cause visual disturbance or noise.
- Leave a distance of at least 59.1" between the air discharge and a fire alarm. If this precaution is not observed, the alarm may not work properly or detect fire in case of fire.

Be careful of operation sounds

- Locate the unit in a place secure enough so that the sounds and vibrations do not increase.
- If something is placed near the air discharge of the outdoor unit, noise may increase.
- Be careful not to disturb your neighbors with cool / warm air or noise coming from the air discharge of the outdoor unit.

7 Notes on operations and performance

■ Check before operation

- Turn on the power switch at least 12 hours before starting operation.
- Make sure the ground wire is securely connected.
- Make sure the air filter is attached to the indoor unit.

■ Defrosting during heating

- If frost falls on the outdoor unit during heating, defrosting is automatically performed (for approximately 2 - 10 minutes) to increase the heating effect.
- The fan of the indoor unit is stopped during defrosting.

■ 3-minute protection

The outdoor unit will not operate for approximately 3 minutes after the air conditioner has been immediately restarted after stopping, or the power switch has been turned on. This is to protect the system.

■ Power failure

- In the case of a power failure, all operations stop.
- To resume operations, push the ON/OFF button.

■ Information on the air conditioning control system

- The temperature setting should be between 61 and 80 °F.
- The temperature of the air conditioning system can be set outside of the range of 61 to 80 °F; however, it may interfere with the temperature adjustment of the indoor unit for air conditioning or may cause the device to fail.

■ Protective device (High pressure switch)

The high pressure switch stops the air conditioner automatically when excessive load is applied to the air conditioner.

If the protective device activates, the unit's running stops and the operation lamp blinks.

When the protective device activates, the  indicator and the check code are displayed on the remote control.

The protective device may activate in the following cases:

During cooling

- When the air intake or air discharge of the outdoor unit is blocked.
- When strong wind blows continuously against the air discharge of the outdoor unit.

During heating

- When dust or dirt is excessively adhered to the air filter of the indoor unit.
- When the air discharge of the indoor unit is blocked.

NOTE

When the protective device activates, turn off the power switch, remove the cause, and then restart running.

■ Cooling / Heating operations

Each unit can be controlled individually. However, indoor units connected to the same outdoor unit cannot perform cooling and heating simultaneously.

When you attempt simultaneous operation, indoor units performing cooling are stopped, and the running preparation indicator  is displayed on the remote control.

An indoor unit performing heating continues running. When you attempt an operation without the configured settings, the running preparation indicator  is displayed on the remote control and operation stops. If operation is fixed to cooling or heating by the air conditioner administrator, only the configured settings apply to the operation.

■ Characteristics of heating

When the outside temperature increases, the outdoor unit may stop.

8 Maintenance

▲ WARNING

For daily maintenance including Air Filter cleaning, make sure to ask the qualified service person particularly following models as the maintenance requires high-place work;

▲ CAUTION

Do not push buttons with wet hands. Doing so may result in electric shock.

Cleaning the air filters (All filters are to be procured locally.)

- When the filter indicator is displayed on the remote control, clean the air filters.
- Ask qualified service person to clean the filters for the models listed in the warning on the top of this chapter.
- Clogged filters may lower the cooling and heating performance.

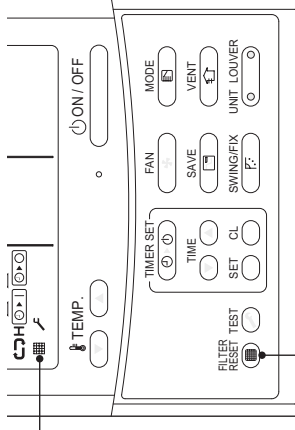

When the cleaning is complete, push the "FILTER RESET" button.

CAUTION

- If any of the following conditions occur, turn off the main power supply switch and immediately contact the dealer:
- Switch operation does not work properly.
 - The main power fuse often blows out, or the circuit breaker is often activated.
 - A foreign matter or water fall inside the air conditioner.
 - When the air conditioner does not operate even after the cause of the protective device activation has been removed, (The operation lamp and \mathcal{L} on the remote control are flashing. When \mathcal{E} , \mathcal{F} , \mathcal{H} , \mathcal{L} , or \mathcal{P} and a number are displayed on the remote control, also inform a qualified service person of the display content.)
 - Any other unusual conditions are observed.

Confirmation and check

When a problem occurred in the air conditioner, the check code and the indoor unit No. appear on the display part of the remote control. The check code is only displayed during the operation. If the display disappears, operate the air conditioner according to the following "Confirmation of check code log" for confirmation.

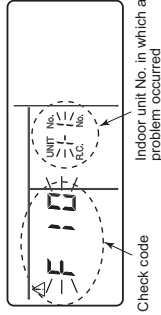

Confirmation of check code log

When a problem occurred on the air conditioner, the check code log can be confirmed with the following procedure. (The check code log is stored in memory up to 4 check code.)
The log can be confirmed from both operating status and stop status.

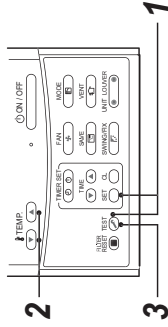

Procedure	Description
1	When pushing SET and TEST buttons at the same time for 4 seconds or more, the following display appears. If [\mathcal{L} Service check] is displayed, the mode enters in the check code log mode. <ul style="list-style-type: none"> • [01 : Order of check code log] is displayed in CODE No. window. • [Check code] is displayed. • [Indoor unit address in which a problem occurred] is displayed in UNIT No.
2	Every pushing of [TEMP / ON/OFF] button used to set temperature, the check code log stored in memory is displayed in order. The numbers in CODE No. indicate CODE No. [01] (latest) to [04] (oldest). CAUTION Do not push ON/OFF button because all the check code log of the indoor unit will be deleted.
3	After confirmation, push TEST button to return to the usual display.

1. Check the check code according to the above procedure.
2. Ask an authorized dealer or qualified service (maintenance) professional to repair or maintain the air conditioner.
3. More details of the check code are explained in Service Manual.

1 Precautions for safety

Installing, starting up, and servicing air-conditioning equipment can be hazardous due to system pressures, electrical components, and equipment location (roofs, elevated structures, etc.). Only trained, qualified installers and service mechanics should install, start-up, and service this equipment. Untrained personnel can perform basic maintenance functions such as cleaning indoor unit air filter. All other operations should be performed by trained service personnel.

Before working on the equipment, observe precautions in the literature and on tags, stickers, and labels attached to the equipment.

Follow all safety codes. Wear safety glasses and work gloves. Use care in handling, rigging, and setting bulky equipment.

Read these instructions thoroughly and follow all warnings or cautions included in literature and attached to the unit. Consult local building codes and National Electrical Code (NEC) for special requirements. Recognize safety information. This is the safety-alert symbol . When you see this symbol on the unit and in instructions or manuals, be alert to the potential for personal injury. Understand these signal words: DANGER, WARNING, and CAUTION. These words are used with the safety-alert symbol.

DANGER identifies the most serious hazards which will result in severe personal injury or death. WARNING signifies hazards which could result in personal injury or death. CAUTION is used to identify unsafe practices which may result in minor personal injury or product and property damage. NOTE is used to highlight suggestions which will result in enhanced installation, reliability, or operation.

The manufacturer shall not assume any liability for the damage caused by not observing the description of this manual.

WARNING

- **Only a qualified installer or service person is allowed to do installation work.** Inappropriate installation may result in water leakage, electric shock or fire.
- **Do not use any refrigerant different from the one specified for complement or replacement.**
- **Otherwise, abnormally high pressure may be generated in the refrigeration cycle, which may result in a failure or explosion of the product or an injury to your body.**
 - **Connect ground wire. (grounding work)**
Incomplete grounding may cause an electric shock.
 - **Do not connect ground wires to gas pipes, water pipes, lightning rods or ground wires for telephone wires.**
 - **Turn off all the circuit breaker before attempting any electrical work.**
Failure to do so may cause electric shock.
 - **Install the refrigerant pipe securely during the installation work before operating the air conditioner.**
If the air conditioner is operated with the valve open and without the refrigerant pipe, the compressor sucks air and the refrigeration cycle is overpressurized, which may cause a burst or injury.
 - **When moving the air conditioner for the installation into another place, do not enter any gaseous matter other than the specified refrigerant into the refrigeration cycle.**
If air or any other gas is mixed in the refrigerant, the gas pressure in the refrigeration cycle becomes abnormally high and it resultingly causes pipe burst and injuries on persons.
 - **Perform installation work properly according to the Installation Manual.**
Inappropriate installation may result in water leakage, electric shock or fire.
 - **When the air conditioner is installed in a small room, provide appropriate measures to ensure that the concentration of refrigerant leakage occur in the room does not exceed the critical level.**
 - **Perform the specified installation work to guard against an earthquake.**
If the air conditioner is not installed appropriately, accidents may occur due to the falling unit.
 - **Install the air conditioner at a height 8' (2.4 m) or more from the floor.**
If you insert your hands or others directly into the unit while the air conditioner operates, it is dangerous because you may contact with revolving fan or active electricity.
 - **If refrigerant gas has leaked during the installation work, ventilate the room immediately.**
If the leaked refrigerant gas comes in contact with fire, noxious gas may generate.
 - **After the installation work, confirm that refrigerant gas does not leak.**
If refrigerant gas leaks into the room and flows near a fire source, such as a cooking range, noxious gas might generate.
 - **Electrical work must be performed by a qualified electrician in accordance with the Installation Manual. Use an exclusive power supply for the air conditioner at the rated voltage.**
An insufficient power supply capacity or inappropriate installation may cause fire.

12. INSTALLATION MANUAL

- Use the specified wires for wiring connect the terminals. Securely fix them to prevent external forces applied to the terminals from affecting the terminals.
- Conform to the regulations of the local electric company when wiring the power supply.

- **For the refrigerant recovery work (collection of refrigerant from the pipe to the compressor), stop the compressor before disconnecting the refrigerant pipe.**

If the refrigerant pipe is disconnected while the compressor is working with the valve open, the compressor sucks air and the refrigeration cycle is overpressurized, which may cause a burst or injury.

- **Before carrying out the installation, maintenance, repair or removal work, set the circuit breaker to the OFF position.**

Otherwise, electric shocks may result.

- **Do not touch the aluminium tin of the unit. You may injure yourself if you do so. If the fin must be touched for some reason, first put on protective gloves and safety work clothing, and then proceed.**

- **Install the air conditioner securely in a location where the base can sustain the weight adequately. If the strength is not enough, the unit may fall down resulting in injury.**

The unit can be accessed from the service panel.

- **Install a circuit breaker that meets the specifications in the installation manual and the stipulations in the local regulations and laws.**

- **Install the circuit breaker where it can be easily accessed by the agent.**



- **Under no circumstances the power wire must not be extended. Connection trouble in the places where the wire is extended may give rise to smoking and/or a fire.**

- **Upon completion of the installation work, tell the user where the circuit breaker is located. If the user does not know where the circuit breaker is, he or she will not be able to turn it off in the event that trouble has occurred in the air conditioner.**

CAUTION

- **This air conditioner adopts the new HFC refrigerant (R410A) which does not destroy ozone layer.**
 - The characteristics of R410A refrigerant are: easy to absorb water, oxidizing membrane or oil, and its pressure is approx. 1.6 times higher than that of refrigerant R22. Accompanied with the new refrigerant, refrigerating oil has also been changed. Therefore, during installation work, be sure that water, dust, former refrigerant, or refrigerating oil does not enter the refrigerating cycle.
 - To prevent charging an incorrect refrigerant and refrigerating oil, the sizes of connecting sections of charging port of the main unit and installation tools are changed from those for the conventional refrigerant.
 - Accordingly the exclusive tools are required for the new refrigerant (R410A).
 - For connecting pipes, use new and clean piping designed for R410A, and please care so that water or dust does not enter.
 - **Tighten the flare nut with a torque wrench in the specified manner.**
Excessive tightening of the flare nut may cause a crack in the flare nut after a long period, which may result in refrigerant leakage.
 - **Wear heavy gloves during the installation work to avoid injury.**

2 Accessory parts

Part name	Q'ty	Shape	Usage
Owner's Manual	1	—	(Be sure to hand over to customers)
Installation Manual	1	This manual	This manual for installer.
Heat insulator	1		For heat insulation of Gas pipe connecting section
	1		For heat insulation of Liquid pipe connecting section
	8		For heat insulation of hanging bracket (AP048 type: 4 pieces, 3.2" (80 mm) (AP072, 096 type: 4 pieces, 5.5" (140 mm))

NOTE

The wired remote control must be connected. Settings cannot be made for systems without remote controls.

3 System control of Outside Air Unit

■ System able to be combined

The Outside Air Unit is connectable to SMMS (Super Modular Multi system).
However this is not connectable to SHRM (Super Heat Recovery Multi system).
Keep the height difference between the Outside Air Units to 1.97" (0.5 m) or less.

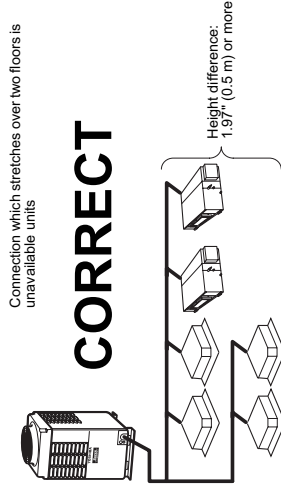

4 Selection of installation place

Avoid installing in the following places.

Select a location for the indoor unit where the cool or warm air will circulate evenly.

- Avoid installation in the following kinds of locations.
 - Locations where inside the ceiling is used as route for outside air.
 - Saline area (coastal area)
 - Locations with acidic or alkaline atmospheres (such as areas with hot springs, factories where chemicals or pharmaceuticals are made and places where the exhaust air from combustion appliances will be sucked into the unit).
- Doing so may cause the heat exchanger (its aluminum fins and copper pipes) and other parts to become corroded.
- Locations with atmospheres with mist of cutting oil or other types of machine oil.
- Doing so may cause the heat exchanger to become corroded, mists caused by the blockage of the heat exchanger to be generated, the plastic parts to be damaged, the heat insulators to peel off, and other such problems to result.
- Places where iron or other metal dust is present. If iron or other metal dust adheres to or collects on the interior of the air conditioner, it may spontaneously combust and start a fire.
- Locations where vapors from food oils are formed (such as kitchens where food oils are used). Blocked filters may cause the air conditioner's performance to deteriorate, condensation to form, the plastic parts to be damaged, and other such problems to result.
- Locations near obstructions such as ventilation openings or lighting fixtures where the flow of the blown air will be disrupted (a disruption of the air flow may cause the air conditioner's performance to deteriorate or the unit to shut down).
- Locations where an in-house power generator is used for the power supply.
- The power line frequency and voltage may fluctuate, and the air conditioner may not work properly as a result.
- On truck cranes, ships or other moving conveyances.
- The air conditioner must not be used for special applications (such as for storing food, plants, precision instruments or art works).
- (The quality of the items stored may be degraded.)
- Locations where high frequencies are generated (by inverter equipment, in-house power generators, medical equipment or communication equipment).
- (Malfunctioning or control trouble in the air conditioner or noise may adversely affect the equipment's operation.)
- Locations where there is anything under the unit installed that would be compromised by wetness. (If the drain has become blocked or when the humidity is over 80%, condensation from the indoor unit will drip, possibly causing damage to anything underneath.)
- Locations where organic solvents are being used.
- The air conditioner cannot be used for liquefied carbonic acid cooling or in chemical plants.
- Location near doors or windows where the air conditioner may come into contact with high-temperature, high-humidity outdoor air. (Condensation may occur as a result.)
- Locations where special sprays are used frequently.

■ Installation space

Keep the space necessary for installation and service.

REQUIREMENT

The check port should be 23.6" × 23.6" (600 × 600 mm).

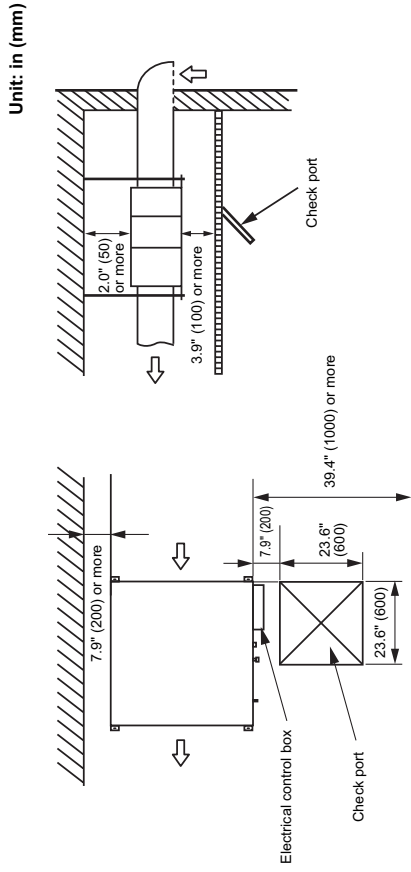

■ Installation under atmosphere of the high humidity

Although it has been confirmed that no trouble occurs on the unit, there is a fear of drip of the water if operation under high humidity condition continues.

In some cases including the rainy season, especially inside of the ceiling may become high-humidity atmosphere (dew-point temperature: 86 °F (30 °C) (humidity: 80% or higher).

- 1 Installation to inside of the ceiling with tiles on the roof.
- 2 Installation to inside of the ceiling with slated roof.
- 3 Installation to inside of the ceiling with kitchen.
 - In the above cases, additionally attach the heat insulator (Glass wool, etc.) to all positions of the air conditioner, which come to contact with the high-humidity atmosphere.
 - In this case, arrange the side plate (Service panel) so that it is easily removed.
 - Apply also heat insulating a sufficient thickness 0.39" (10 mm) or more to the duct and connecting part of the duct.

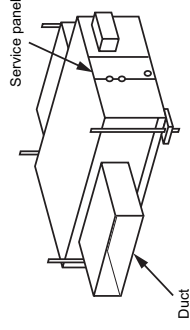

5 Installation

⚠ WARNING

Install the air conditioner certainly to sufficiently withstand the weight. If the strength is insufficient, the unit may fall down resulting in human injury. Perform a specified installation work to guard against strong wind or earthquake. An incomplete installation can cause accidents by the units falling and dropping.

REQUIREMENT

- Strictly comply with the following rules to prevent damage of the indoor units and human injury.
- Do not put a heavy article on the indoor unit. (Even units are packaged)
 - Carry in the indoor unit as it is packaged if possible.
 - If carrying in the indoor unit unpacked by necessity, be sure to use buffering cloth, etc. to not damage the unit.
 - To move the indoor unit, hold the hooking metals (4 positions) only.
 - Do not apply force to the other parts (refrigerant pipe, drain pan, foamed parts, or resin parts, etc.).
 - Carry the package by two or more persons, and do not bundle it with PP band at positions other than specified.
 - Use a forklift to transport materials. Do not drag or push the package because it is made of cardboard.
 - If the vibration insulator is applied to the hanging bolt, make sure it does not cause larger vibration in the main unit before using it.

External view

Installing the four 3/8" (M10)-diameter hanging bolts

- Space the hanging bolts according to the dimensions shown in the diagrams below.
- Use 3/8" (M10)-diameter hanging bolts (Required at the site).

Unit: in (mm)

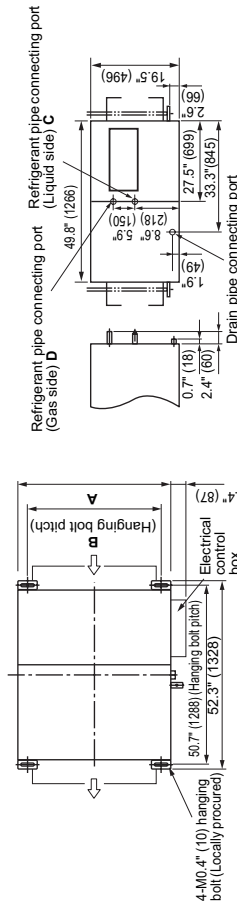

Model MMD-	A	B	C	D
AP048*	35.4" (898)	32.2" (818)	Ø3/8" (9.5) flare	Ø5/8" (15.9) flare
AP072* AP096*	55" (1398)	49.6" (1260)	Ø1/2" (12.7) flare	Ø7/8" (22.2) brazing

Considering piping and wire connecting works in the ceiling after hanging down the indoor unit, select an installation place and then determine the drawing-out direction of the pipes.

- If the ceiling has been already set, draw the refrigerant pipe, drain pipe, inter-unit wire between indoor and outdoor units, central control system wire and remote control cord up to the positions where pipes and wires are connected before hanging down the indoor unit.

Treatment of ceiling

The ceiling differs according to structure of building. For details, consult your constructor or interior finish contractor. In the process after the ceiling board has been removed, it is important to reinforce ceiling foundation (frame) and to keep horizontal level of installed ceiling correctly in order to prevent vibration of ceiling board.

Installation of hanging bolt

Use 3/8" (M10) hanging bolts (4 pcs, locally procured).

Matching to the existing structure, set pitch according to size in the unit external view as shown below.

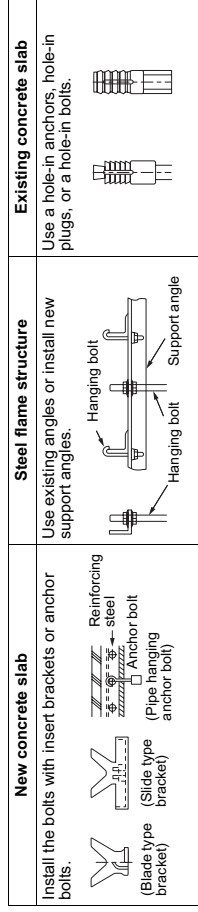

Hanging up of unit

- Adjust the nut position (lower side).
- Hang up the main unit by hanging nut of hanging bolt to T groove of hanging bracket of the indoor unit.
- Using the level vial, etc., check that four sides are horizontal. (Horizontal degree: within 0.2" (5 mm))
- Attach canvas ducts (locally procured) to the air intake and the air discharge so that vibration of the main unit does not travel to the duct or ceiling. Attach also acoustic-absorption material to the inner liner of the duct and the vibration-proof rubber to the hanging bolt.

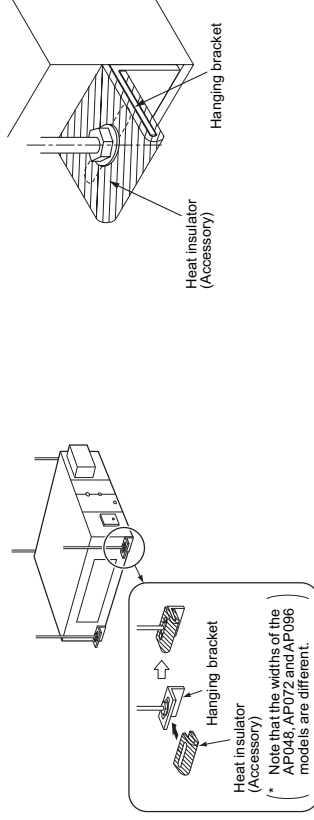

REQUIREMENT

- Using a level vial, etc., confirm the horizontal level of the indoor unit.
- Tighten the nut sufficiently, and fix it securely.

■ Installation of indoor unit

- 1 Install temporarily the indoor unit.**
Attach the hanging bracket to the hanging bolt.
Be sure to fix the hanging bracket from both up and down sides of the hanging bracket by using the nuts (3/8" (M10) locally procured) and the washer.
- 2 Using nut, adjust height of the main unit.**
- 3 Check the main unit is horizontally installed.**
Attach canvas ducts (locally procured) to the air intake and the air discharge so that vibration of the main unit does not travel to the duct or ceiling.
Attach also acoustic-absorption material to the inner liner of the duct and the vibration-proof rubber to the hanging bolt.

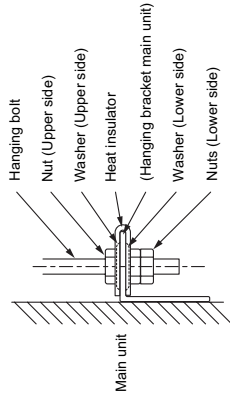

■ REQUIREMENT

Make sure that the unit is hanging level.
If it is hung horizontally, the drain pan may overflow. Install the unit within the dimensions indicated below.

Front view

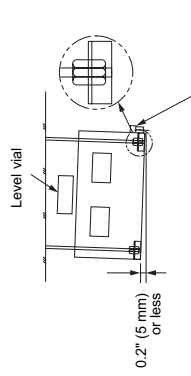

Install the main unit within 0.2" (5 mm) while lowering the drain pipe connecting port side slightly.

Side view

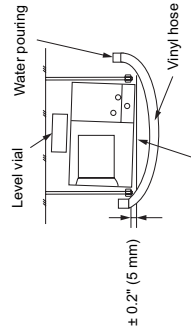

Install both air intake and air supply port sides within ± 0.2" (5 mm).

Using a level vial or vinyl hose, check whether the indoor unit is hung horizontally or not.

6 Duct work

▲ CAUTION

Be sure to apply heat insulation to the duct to prevent dewy condition.
If there is an incomplete duct work, the water leakage into the room may happen.

■ REQUIREMENT

- In order to prevent short circuits, design the duct work so that the intake and discharge openings are not adjacent to each other.
- Install the filter chamber on the intake side of the indoor unit. Attach the long life prefilter and high-efficiency filter to the filter chamber to remove dust. Send outside air to the inside of the indoor unit and the area being air conditioned.
- If no air filter is installed, dust will collect in the heat exchanger, which may cause the air conditioner to fail or to leak.
- Be sure to set the duct at air intake side with descending inclination because the suction duct of the this unit is exposed to outdoors and therefore rainwater, leaves and birds are easy to enter in if it is set horizontally. Attaching wire netting and others to end of the suction duct is also recommended.
- Connect the duct so that the air intake sucks outside air only.
- Be sure to apply heat insulation for the duct to prevent dewing.
(Recommended material: Glass wool or foam polyethylene, Thickness: 1.0" (25 mm))
- When welding the duct at the site, sparks may enter in the air filter or heat insulator.
- To avoid spread of the fire, cover the duct with iron plate, etc.
- When penetrating metal lath, wire lath or metal plank with the metal duct, isolate the duct from the wall electrically.
- Set the canvas ducts at air intake port and air supply port. It is to avoid conveyance of vibration, abnormal resonance sound and also to make easy the disassembly of the main unit in service time.
- Connect the ducts so that the ducts do not weight on the main unit.
If connecting the ducts directly to the main unit, the duct vibration abnormal sound from the main unit may happen, and also the filter and service panel cannot be detached.
- Be sure to fix the ducts by using the hanging bolts.

■ Duct work

After installing the product, perform the duct work according to the working diagram.

■ Connecting flange

Refer to size in the figure attached to the main unit.

<MMD-AP048 type>

<Air supply port connecting flange>

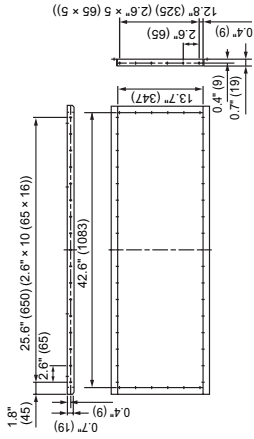

<MMD-AP072 type, AP096 type>

<Air supply port connecting flange>

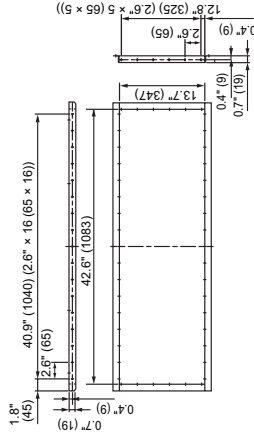

<Air intake port connecting flange>

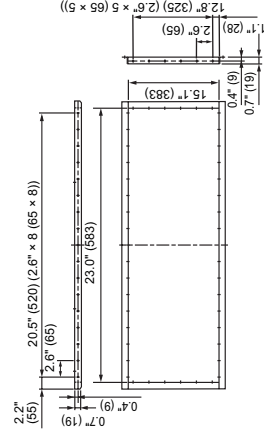

<Air intake port connecting flange>

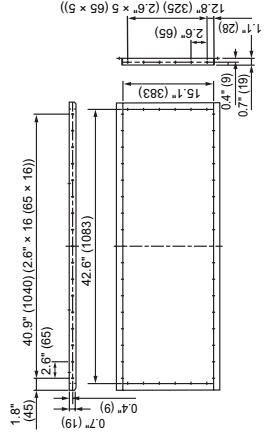

REQUIREMENT

If the air conditioner unit and the canvas joint are connected with the rivets, the fan and the refrigerating cycle cannot be checked.

Be sure to use the flange as shown in the above and tighten it by the bolts.

(Fixing bolts 0.2" x 0.5" (6 x 12 mm), locally procured)

<Example of construction>

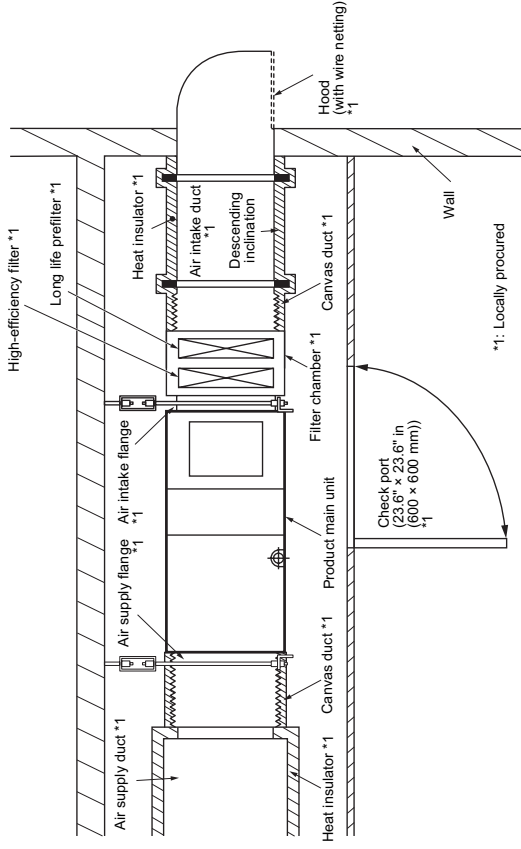

1 Air intake duct

- Connect the air intake duct (Locally procured) to the inlet flange. Wrap aluminum tape around connecting part between the air intake port flange and duct, or provide sealer so that air does not leak.
- For the outside air intake port, attach a hood so that outside air is sucked from lower side. And attach wire netting, etc. to the air intake of the hood.
- Set the air intake duct at descending inclination so that water can be drained even if rainwater enters in.
- Wrap the outside of the intake duct with heat insulator because it intakes cold air while heating.

2 Air supply duct

- Connect the air supply duct (Locally procured) to the Air supply flange. Wrap aluminum tape around connecting part of the air supply port flange and duct or apply packing so that air does not leak.

7 Fan characteristics

■ Fan characteristics

<MMD-AP048 type>

(Standard air volume: 636 cfm, Lower limit air volume: 445 cfm, Upper limit air volume: 700 cfm)

1-2. 230V Fan characteristics

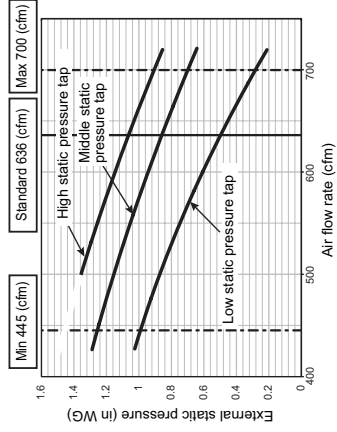

2-2. 208V Fan characteristics

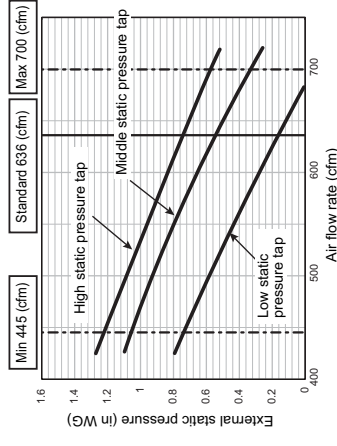

1-3. 230V cfm-A

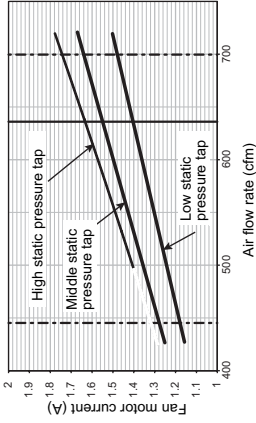

2-3. 208V cfm-A

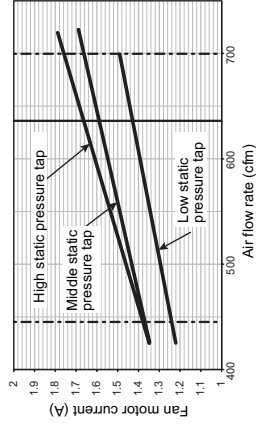

REQUIREMENT

Set a volume damper to the air supply duct, and then adjust the air volume so that it is kept in the range of 70 to 110% against the standard air volume.

<MMD-AP072 type>

(Standard air volume: 989 cfm, Lower limit air volume: 693 cfm, Upper limit air volume: 1088 cfm)

1-2. 230V Fan characteristics

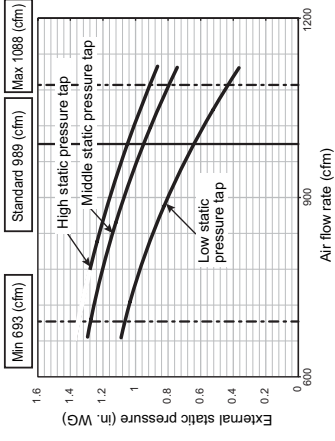

2-2. 208V Fan characteristics

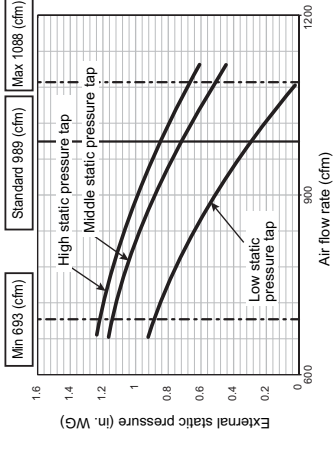

1-3. 230V cfm-A

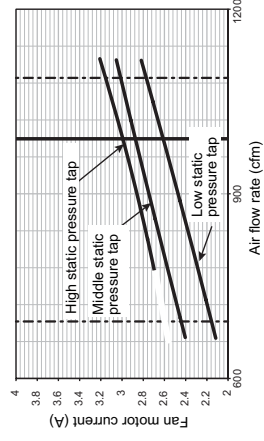

1-3. 208V cfm-A

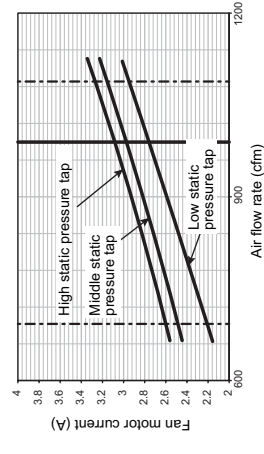

REQUIREMENT

Set a volume damper to the air supply duct, and then adjust the air volume so that it is kept in the range of 70 to 110% against the standard air volume.

<MMD-AP096 type>

(Standard air volume: 1237 cfm, Lower limit air volume: 866 cfm, Upper limit air volume: 1360 cfm)

1-2. 230V Fan characteristics

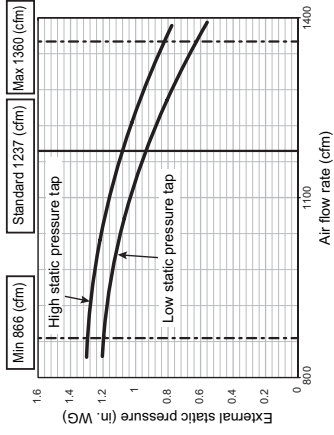

2-2. 208V Fan characteristics

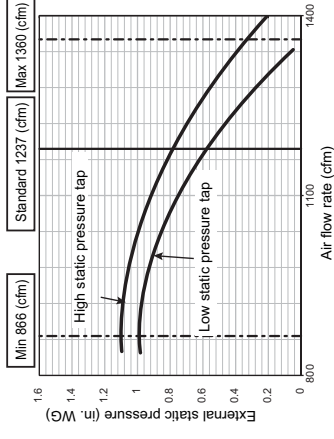

1-3. 230V cfm-A

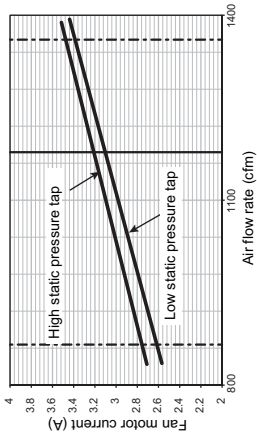

2-3. 208V cfm-A

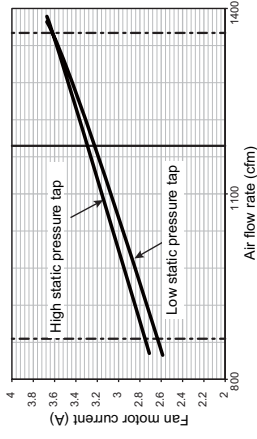

■ Wire connection change of fan motor

The motor wires for the fan have been connected to (E2) at shipment from the factory. Change the wire connection if change of the external static pressure is required due to the duct resistance.

<MMD-AP048 type>

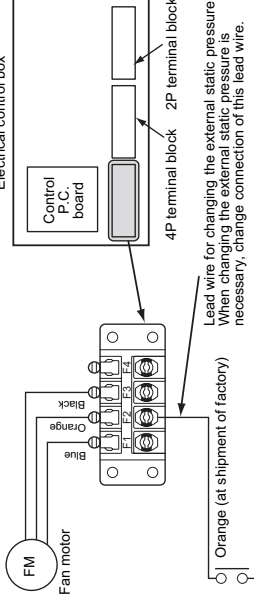

<MMD-AP072 type, AP096 type>

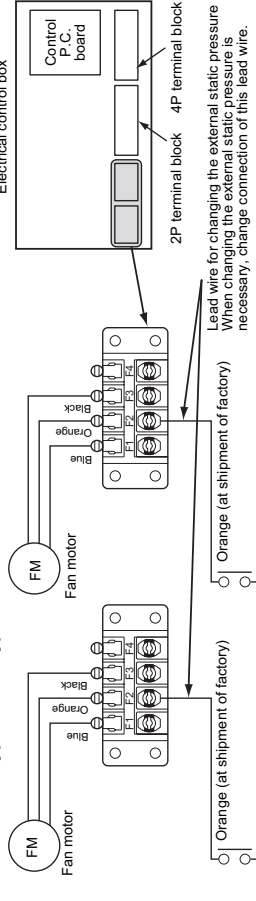

REQUIREMENT

When the external static pressure was changed, enter the changed static pressure value in the identification plate of the unit.

<MMD-AP048, AP072 type>

Terminal block No.	Fan motor wiring	Remarks
F1 (Low static pressure tap)	Blue	—
F2 (Middle static pressure tap)	Orange	At shipment from factory
F3 (High static pressure tap)	Black	—

<MMD-AP096 type>

Terminal block No.	Fan motor wiring	Remarks
F1 (-)	Blue	Not used.
F2 (Low static pressure tap)	Orange	At shipment from factory
F3 (High static pressure tap)	Black	—

REQUIREMENT

Set a volume damper to the air supply duct, and then adjust the air volume so that it is kept in the range of 70 to 110% against the standard air volume.

8 Drain piping

⚠ CAUTION

Following the Installation Manual, perform the drain piping work that water is properly drained, and apply a heat insulation not to cause a dew condensation.

Inappropriate piping work may cause the water leakage in the room and wet of furniture.

REQUIREMENT

- The drain piping flows the natural drainage. Make sure to set the drain piping from the unit with descending slope of 1/50 to 1/100 and do not make up-down or trap in the midway.
- Set the horizontal pulling of the drain pipe to 65.7" (20 m) or less. When drain piping is too long, attach the support bracket at intervals of 4'11" to 6'7" (1.5 m to 2 m) to avoid the pipe becomes undulant as shown in figure below.

<Example for installation of the main piping (Incl. piping support)>

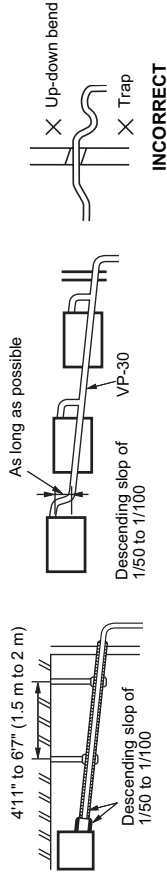

INCORRECT

- Be sure to connect the drain pipe to the air conditioner with adhesive to avoid water leakage from the joint portion.
- Condensation may occur on the drain pipes including collective pipes. All drain pipes must be wrapped with heat insulator to prevent dew condensation. Especially a part where drain pipe is connected to the indoor unit must be firmly insulated with the provided heat insulator.

■ Pipe material, size and insulator

The following materials for piping work and insulating process are locally procured.

Pipe material	Hard vinyl chloride pipe socket for VP25 Hard vinyl chloride pipe VP25 (Nominal outer diameter: Ø1.3" (32 mm))
Insulator	Foamed polyethylene foam, thickness: 0.4" (10 mm) or more

■ Connecting drain pipe

REQUIREMENT

- Using adhesive agent for vinyl chloride, connect the hard vinyl chloride pipes certainly so that water does not leak.
- It takes some time to dry and inactivate the adhesive agent. (Refer to the manual of adhesive agent.) Do not apply any extra force on the connecting section until the adhesive agent dried.

■ Check the draining

Check the water drainage is surely performed at the test run. Check also no water leakage is found at the pipe connecting part.

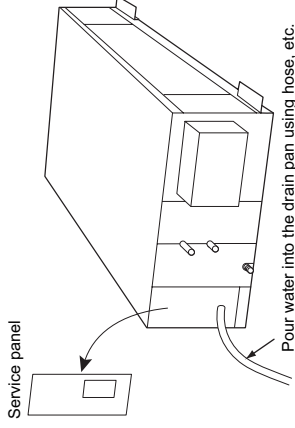

REQUIREMENT

- Be sure to check draining even if installing the unit in heating season.
- Using a kettle or hose, pour water gradually from the drain pan at the air supply port.

9 Refrigerant piping

CAUTION

When the refrigerant pipe is long, provide support brackets at intervals of 8'2" to 9'10" (2.5 m to 3 m) to clamp the refrigerant pipe. Otherwise, abnormal sound may be generated.

Use the flare nut attached with the indoor unit or R410A flare nut.

Use general copper pipes with a wall thickness of 0.03" (0.8 mm) for Ø1/2" (12.7 mm), and with a wall thickness of 0.04" (1.0 mm) for Ø7/8" (22.2 mm) (half hard). Do not use any copper pipes with a wall thickness less than these thicknesses.

Permissible piping length and height difference

They vary depending on the outdoor unit. For details, refer to the Installation Manual attached to the outdoor unit.

Pipe size

Model	IM1D-	AP048	AP072, AP096
Pipe size (Unit: in (mm))	Gas side	Ø5/8" (15.9 mm)	Ø7/8" (22.2 mm)
	Liquid side	Ø3/8" (9.5 mm)	Ø1/2" (12.7 mm)

- The pipe (Ø7/8" (22.2 mm)) at gas side is connected with brazing.

Liquid side refrigerant pipe connection

Flaring

- Cut the pipe with a pipe cutter.**
Remove burrs completely. (Remaining burrs may cause gas leakage.)

- Insert a flare nut into the pipe, and flare the pipe.**

Use the flare nut provided with the unit or the one used for the R410A refrigerant. The flaring dimensions for R410A are different from the ones used for the conventional R22 refrigerant. A new flare tool manufactured for use with the R410A refrigerant is recommended, but the conventional tool can still be used if the projection margin of the copper pipe is adjusted to be as shown in the following table.

Projection margin in flaring: B (Unit: in (mm))

Outer dia. of copper pipe	R410A tool used	Conventional tool used
3/8" (9.5)	0 - 0.02" (0 - 0.5)	0.04" - 0.06" (1.0 - 1.5)
1/2" (12.7), 5/8" (15.9)		

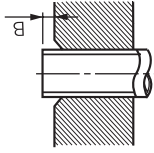

Flaring diameter size: A (Unit: in (mm))

Outer dia. of copper pipe	A +0 -0.4
3/8" (9.5)	0.52" (13.2)
1/2" (12.7)	0.65" (16.6)
5/8" (15.9)	0.78" (19.7)



- In case of flaring for R410A with the conventional flare tool, pull it out approx. 0.02" (0.5 mm) more than that for R22 to adjust to the specified flare size. The copper pipe gauge is useful for adjusting projection margin size.

- The sealed gas was sealed at the atmospheric pressure so when the flare nut is removed, there will no "whooshing" sound: This is normal and is not indicative of trouble.
- Use two wrenches to connect the indoor unit pipe.

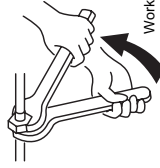

- Use the tightening torque levels as listed in the table below.

Outer dia. of connecting pipe (mm)	Tightening torque (Unit: ft-lbs (N·m))
3/8" (9.5)	24 -31 (33 - 42)
1/2" (12.7)	37 -46 (50 - 62)
5/8" (15.9)	46 -57 (63 -77)

- Turn back the pipe heat insulator and tie up with a banding band.



Airtight test / air purge, etc.

For air tightness test, adding refrigerant, refer to the Installation Manual attached to the outdoor unit.

CAUTION

Do not supply power to the indoor unit until the airtight test and vacuuming are completed. (If the indoor unit is powered on, the pulse motor valve is fully closed, which extends the time for vacuuming.)

Open the valve fully

Open the valve of the outdoor unit fully.

Heat insulation process

Apply heat insulation for the pipes separately at liquid side and gas side.

- For the heat insulation to the pipes at gas side, use the material with heat-resisting temperature 248°F (120°C) or higher.
- To use the attached heat insulation pipe, apply the heat insulation to the pipe connecting section of the indoor unit securely without gap.

REQUIREMENT

- Apply the heat insulation to the pipe connecting section of the indoor unit securely up to the root without exposure of the pipe. (The pipe exposed to the outside causes water leak.)
- Wrap heat insulator with its slits facing up (ceiling side).

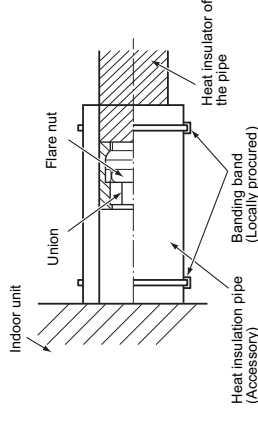

- Tightening torque of flare pipe connections. Pressure of R410A is higher than that of R22. (Approx. 1.6 times) Therefore, using a torque wrench, tighten the flare pipe connecting sections which connect the indoor and outdoor units of the specified tightening torque. Incorrect connections may cause not only a gas leak, but also a trouble of the refrigeration cycle.

CAUTION

Tightening with an excessive torque may crack the nut depending on installation conditions.

Gas side refrigerant pipe connection

- The brazing connections on the gas side are AP072 and AP096 models.

- Turn up the pipe heat insulator to the unit side.
- Wrap the pipe with wet cloth.

Turn up pipe heat insulator

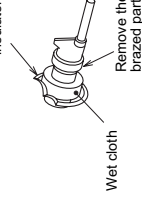

- Remove the cup on the gas side piping by using a brazing machine.

CAUTION

Do not burn the pipe heat insulator.

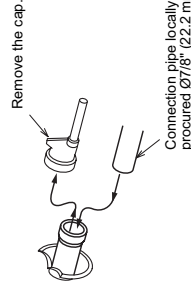

- Braze the connection piping to the joint part.

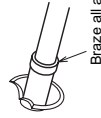

10 Electrical connection

⚠ WARNING

- Use predefined wire and connect them certainly. Keep the connecting terminal free from external force.
Improper wire connection or clamping may result in exothermic, fire or malfunction.
- Connect ground wire. (grounding work)
Incomplete grounding cause an electric shock.
Do not connect ground wires to gas pipes, water pipes, lightning rods or ground wires for telephone wires.
- Install appliance in accordance with national wiring regulations.
Capacity shortage of circuit breaker or incomplete installation may cause an electric shock or a fire.

⚠ CAUTION

- Consult local building codes, NEC (National Electrical Code) or CEC (Canadian Electrical Code) for special requirements.
- If incorrect/ incomplete wiring is carried out, it will cause an electrical fire or smoke.
- Install circuit breaker is not tripped by shock waves. If circuit breaker is not installed, an electric shock may be caused.
- Use the cord clamps attached to the product.
- Do not damage or scratch the conductive core and inner insulator of power and control wires when peeling them.
- Use the power cord and control wire of specified thickness, type, and protective devices required.
- Do not connect 208 / 230 V power to the terminal blocks (U1, U2, A, B etc.) for control wiring.
(Otherwise, the system will fail.)
- Perform the electric wiring so that it does not come to contact with the high-temperature part of the pipe.
The coating may melt resulting in an accident.
- Do not turn on the circuit breaker of the indoor unit until vacuuming of the refrigerant pipes completes.

REQUIREMENT

- For power supply wiring, strictly conform to the Local Regulation in each country.
- Run the refrigerant piping line and control wiring line in the same line.

■ Power supply wire and control wires specifications

Power supply wire and control wires are locally procured.

For the power supply specifications, follow to the right table. If capacity is little, it is dangerous because overheating or seizure may be caused.

Indoor unit power supply

For the power supply of the indoor unit, prepare the exclusive power supply separated from that of the outdoor unit.

Power supply

Power supply	208 / 230-150
--------------	---------------

Control wiring, Central control wiring

- 2-core with non-polarity wires are used for the control wiring between indoor unit and outdoor unit and Central control wiring.
- To prevent noise trouble, use 2-core shielded wire.
- The length of the communication line means the total length of the control wire length between indoor and outdoor units added with the central control wire length.

Power supply wire

Select wire size based on the MCA.

▼ Electric characteristics

Model	Power Supply	Voltage Range (V)		MCA (A)	MOCP (A)
		Min	Max		
MMD-AP0481HF2UL	208 / 230 V-1-60 Hz	187	253	2.30	15
MMD-AP0721HF2UL				4.29	15
MMD-AP0961HF2UL				4.76	15

MCA : Minimum Circuit Amps
MOCP : Maximum Overcurrent Protection (Amps)

Control wire

Control wiring between indoor units, and outdoor unit (2-core shielded wire)	Wire size	(Up to 3280'10" (1000 m)) AWG16 (Up to 65618" (2000 m)) AWG14
--	-----------	--

Remote control wiring

2-core with non-polarity wire is used for wiring of the remote control wiring and group remote controls wiring.

Remote control wiring, remote control inter-unit wiring	Wire size: AWG20
Total wire length of remote control wiring and remote control inter-unit wiring = L + L1 + L2 + ... Ln	Up to 1640'5" (500 m) Up to 1312'4" (400 m)
Total wire length of remote control inter-unit wiring = L1 + L2 + ... Ln	Up to 656'2" (200 m)

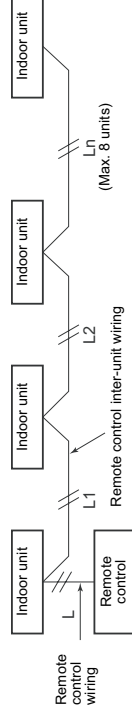

NOTE

- Use copper supply wire.
- Use UL wire rated 600 V for the power supply.
- Use UL wire rated 300 V for the remote control wires and control wires.

⚠ CAUTION

The remote control wire (Communication line) and AC208 / 230 V wires cannot be parallel to contact each other and cannot be stored in the same conduits. If doing so, a trouble may be caused on the control system due to noise or other factor.

■ Wiring between indoor and outdoor units

▲ CAUTION

The Outside Air Unit and indoor unit for air conditioning cannot be controlled as a group.

■ NOTE

An outdoor unit connected with control wiring between indoor and outdoor units wire becomes automatically the header unit.

▼ Wiring example

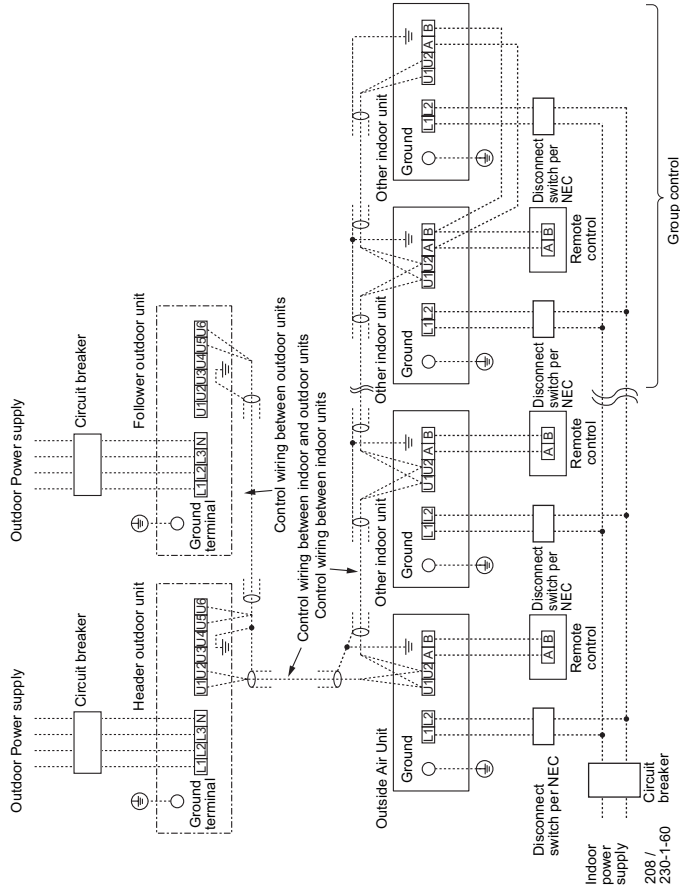

■ Wire connection

REQUIREMENT

- Connect the wires matching the terminal numbers. Incorrect connection causes a trouble.
- Pass the wires through the bushing of wire connection holes of the indoor unit.
- Keep a margin (Approx. 100 mm) on a wire to hang down the electrical control box at servicing or other purpose.
- The low-voltage circuit is provided for the remote control. (Do not connect the high-voltage circuit)
- Remove the cover of the electrical control box by taking off the mounting screws (2 positions).
- Tighten the screws of the terminal block, and fix the wires with cord clamp attached to the electrical control box. (Do not apply tension to the connecting section of the terminal block.)
- Set a loop for the connecting wire of the storing part of the indoor unit electrical control; otherwise the electrical control box cannot be drawn out in service time.
- Mount the cover of the electrical control box without pinching wires.

<MMD-AP048 type>

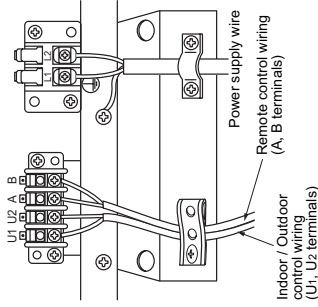

<MMD-AP072 type, AP096 type>

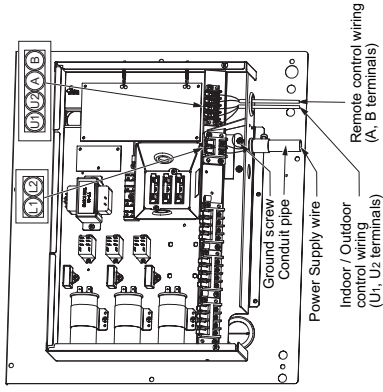

■ Power supply wires and ground wire

1. Strip the wire ends.
Power supply wire: 0.4" (10 mm)
Ground wire: 0.8" (20 mm)
2. Match the wire colors with the terminal numbers on the indoor units' and circuit breakers' terminal blocks and firmly screw the wires to the corresponding terminals.
3. Secure the ground wire with the ground screw.
4. Fix the wires with a cord clamp.

Unit: in (mm)

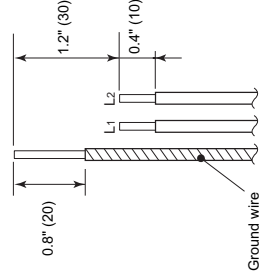

CAUTION

Firmly tighten the screws of the terminal block.

Keep the wire length as shown in figure below when it is connected to the terminal block.

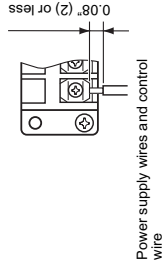

Remote control wiring

Strip off approx. 9 mm the wire to be connected.

Wiring diagram

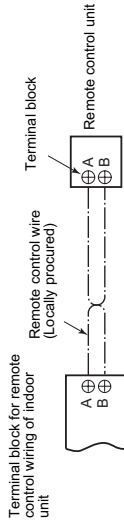

Address setup

Set up the addresses as per the Installation Manual supplied with the outdoor unit.

11 Applicable controls

REQUIREMENT

When the air conditioner is used for the first time, it will take some moments after the power has been turned on before the remote control becomes available for operations. This is normal and is not indicative of trouble.

- Concerning the automatic addresses (The automatic addresses are set up by performing operations on the outdoor interface circuit board.)

While the automatic addresses are being set up, no remote control operations can be performed. Setup takes up to 10 minutes (usually about 5 minutes).

- When the power is turned on after automatic address setup

It takes up to 10 minutes (usually about 3 minutes) for the outdoor unit to start operating after the power has been turned on.

Before the air conditioner was shipped from the factory, all units are set to [STANDARD] (factory default). If necessary, change the indoor unit settings.

The settings are changed by operating the wired remote control.

* The settings cannot be changed using only a wireless remote control, simple remote control or group control remote control by itself so install a wired remote control separately as well.

Basic procedure for changing settings

Change the settings while the air conditioner is not working. (**Stop the air conditioner before making settings.**)

CAUTION

Set only the CODE No. shown in the following table: Do NOT set any other CODE No.
If a CODE No. not listed is set, it may not be possible to operate the air conditioner or other trouble with the product may result.

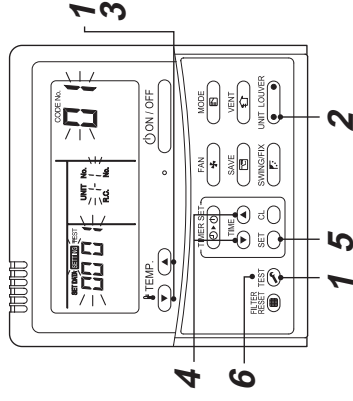

1 Push and hold **TEMP.** button and "TEMP." button simultaneously for at least 4 seconds. After a while, the display flashes as shown in the figure. Confirm that the CODE No. is [01].

- If the CODE No. is not [01], push **TEMP.** button to clear the display content, and repeat the procedure from the beginning. (No operation of the remote control is accepted for a while after the **TEMP.** button is pushed.)
- While air conditioners are operated under the group control, "ALL" is displayed first. When **TEMP.** is pushed, the indoor unit number displayed following "ALL" is the header unit.)

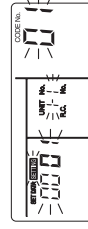

(* Display content varies with the indoor unit model.)

- 2** Each time **UNIT LOWER** button is pushed, indoor unit numbers in the control group change cyclically. Select the indoor unit to change settings for.

The fan of the selected unit runs and the louvers start swinging. The indoor unit for change settings can be confirmed.

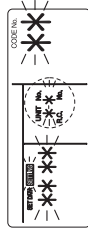

- 3** Specify CODE No. [**x] with "TEMP." / buttons.
- 4** Select SET DATA [***x] with "TIME" / buttons.

- 5** Push button. When the display changes from flashing to lit, the setup is completed.

- To change settings of another indoor unit, repeat from Procedure 2.
 - To change other settings of the selected indoor unit, repeat from Procedure 3.
- Use button to clear the settings. To make settings after button was pushed, repeat from Procedure 2.

- 6** When settings have been completed, push button to determine the settings. When button is pushed, **SETTING** flashes and then the display content disappears and the air conditioner enters the normal stop mode. (While **SETTING** is flashing, no operation of the remote control is accepted.)

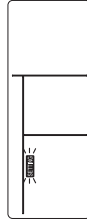

Filter sign setting

According to the installation condition, the filter sign term (Notification of filter cleaning) can be changed. Follow to the basic operation procedure

- (1 → 2 → 3 → 4 → 5 → 6).
- For the CODE No. in Procedure 3, specify [01].
 - For the [SET DATA] in Procedure 4, select the SET DATA of filter sign term from the following table.

SET DATA	Filter sign term
0000	None
0001	150 H
0002	2500 H (Factory default)
0003	5000 H
0004	10000 H

Setting the level of dirtiness for the filter

The time when the filter indicator lights can be changed to half depending on the level of dirtiness.

- Follow to the basic operation procedure (1 → 2 → 3 → 4 → 5 → 6). Perform the operation.
- Specify [02] for the CODE No. in Procedure 3.
 - The SET DATA in Procedure 4 is [0001].

SET DATA	0000	0001
Filter sign term	Normal	Half

Group control

In a group control, a remote control can control up to maximum 8 units.

The Outside Air Unit and indoor unit for air conditioning cannot be controlled as a group.

- For wiring procedure and wires of the individual line (identical refrigerant line) system, refer to "Electrical connection" in this Manual.
- Wiring between indoor units in a group is performed in the following procedure.
- Connect the indoor units by connecting the remote control wires from the remote control terminal blocks (A, B) of the indoor unit connected with a remote control to the remote control terminal blocks (A, B) of the other indoor unit. (Non-polarity)
- For address setup, refer to the Installation Manual attached to the outdoor unit.

12 Test run

Before test run

- Before turning on the power supply, carry out the following procedure.
 - By using 500 V-megger, check that resistance of 1 MΩ or more exists between the terminal block L to N and the grounding.
 - Check the valve of the outdoor unit being opened fully.
- To protect the compressor at activation time, leave power-ON for 12 hours or more before operating.
- Do not press the electromagnetic contactor to forcibly perform a test run. (This is very dangerous because the protective device does not work.)
- Before starting a test run, set addresses by following the Installation Manual supplied with the outdoor unit.

Execute a test run

- When a fan operation is to be performed for an individual indoor unit, turn off the power, short CN72 on the circuit board, and then turn the power back on. (First set the operating mode to "fan," and then operate.) When the test run has been performed using this method, do NOT forget to release the shorting of CN72 after the test run is completed.

Operate the unit with the wired remote control as usual.

For the procedure of the operation, refer to the attached Owner's Manual to the outdoor unit.

A forced test run can be executed in the following procedure even if the operation stops by thermostat-OFF. In order to prevent a serial operation, the forced test run is released after 60 minutes have passed and returns to the usual operation.

CAUTION

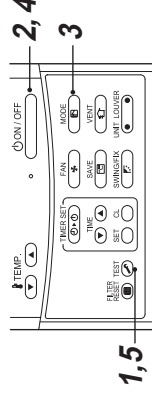

Do not use the forced test run for cases other than the test run because it applies an excessive load to the devices.



- 1** Push button for 4 seconds or more. [TEST] is displayed on the display part and the selection of mode in the test mode is permitted.



- 2** Push button.

- 3 Select the operation mode with  button, [ Cool] or [ Heat].**
- Do not run the air conditioner in a mode other than [ Cool] or [ Heat].
 - The temperature controlling function does not work during test run.
 - The detection of trouble is performed as usual.



- 4 After the test run, push  button to stop a test run.**
(Display part is same as procedure 1.)
- 5 Push  button to cancel (release from) the test run mode.**
([TEST] disappears on the display and the status returns to a normal.)

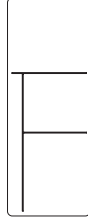

◆ Requirements for turning thermostat OFF

Cooling operation

- When the outside air temperature is lower than or equal to 66.2 °F (19 °C).
- When the outside air temperature is lower than or equal to 37 °F (3 °C) above the set temperature.

Heating operation

- When the outside air temperature is lower than or equal to 23 °F (-5 °C).
- When the outside air temperature is higher than or equal to 59 °F (15 °C).
- When the outside air temperature is higher than or equal to 37 °F (3 °C) above the set temperature.

13 Troubleshooting

■ Confirmation and check

When a problem occurred in the air conditioner, check code and indoor UNIT No. appear on the display part of the remote control.

The check code is only displayed during the operation.

If the display disappears, operate the air conditioner according to the following "Confirmation of check code log" for confirmation.

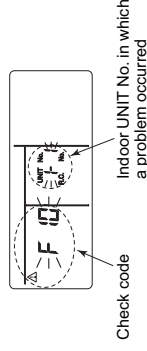

■ Confirmation of check code log

When a problem occurred on the air conditioner, the check code log can be confirmed with the following procedure. (The check code log is stored in memory up to 4 check code.)

The log can be confirmed from both operating status and stop status.

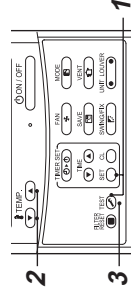

- 1 When  and  buttons are pushed simultaneously for 4 seconds or more, the following display appears.**

If  is displayed, the mode enters in the check code log mode.

- [01: Order of check code log] is displayed in CODE No.
- [Check code] is displayed in CHECK.
- [Indoor unit address in which a problem occurred] is displayed in Unit No.

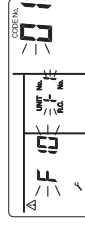

- 2 Every pushing of  button used to set temperature, the check code log stored in memory is displayed in order.**
The numbers in CODE No. indicate CODE No. [01] (latest) → [04] (oldest).

REQUIREMENT

Do not push  button because all the check code log of the indoor unit will be deleted.

- 3 After confirmation, push  button to return to the usual display.**

■ Check codes and parts to be checked

Check method

On the remote control (Wired remote control, Central control remote control) and the interface P.C. board of the outdoor unit (I/F), a check display LCD (Remote control) or 7-segment display (on the outdoor interface P.C. board) to display the operation is provided. Therefore the operation status can be known. With this self-diagnosis function, a trouble or position with trouble of the air conditioner can be found as shown in the table below.

Check code list

- The following list shows each check code. Find the check contents from the list according to part to be checked.
- To check from indoor remote control: See "Wired remote control display" in the list.
 - To check from outdoor unit: See "Outdoor 7-segment display" in the list.
 - To check from indoor unit with a wireless remote control: See "Sensor block display of receiving unit" in the list.

IPDU : Intelligent Power Drive Unit
 O : Lighting, □ : Flashing, ● : Goes off
 ALT : Flashing is alternately when there are two flashing LED.
 SIM : Simultaneous flashing when there are two flashing LED.

Wired remote control display	Check code		Wireless remote control			Judging device			
	Outdoor 7-segment display	Auxiliary code	Sensor block display of receiving unit						
				Operation	Timer	Ready	Flash		
E01	—	—	□	●	●	●	●	Communication trouble between indoor control (Detected at remote control side)	Remote control
E02	—	—	□	●	●	●	●	Remote control transmission trouble	Remote control
E03	—	—	□	●	●	●	●	Communication trouble between indoor and outdoor (Detected at indoor side)	Indoor
E04	—	—	●	●	□	●	●	Communication circuit trouble between indoor and outdoor (Detected at indoor side)	Indoor
E06	—	No. of indoor units in which sensor has been normally received	●	●	□	●	□	Decrease of No. of indoor units	I/F
E07	—	—	●	●	□	●	□	Communication circuit trouble between indoor and outdoor (Detected at outdoor side)	I/F
E08	—	Duplicated indoor addresses	□	●	●	●	●	Duplicated indoor addresses	Indoor / I/F
E09	—	—	□	●	●	●	●	Duplicated header remote controls	Remote control
E10	—	—	□	●	●	●	●	Communication trouble between indoor and MCU	Indoor
E12	01: Indoor / Outdoor communication 02: Communication between outdoor units	—	□	●	●	●	●	Automatic address start trouble	I/F
E15	—	—	●	●	□	●	□	Indoor is nothing during automatic addressing	I/F
E16	00: Capacity over 01 ~ No. of connected units	—	●	●	□	●	□	Capacity over / No. of connected indoor units Combined capacity of indoor units Exceeds the capacity of outdoor units. (SIMMS1 only)	I/F
E18	—	—	□	●	●	●	●	Communication trouble between indoor units	Indoor
E19	00: Header is nothing 02: Two or more header units	—	●	●	□	●	□	Outdoor header units quantity trouble	I/F
E20	01: Outdoor of other line connected 02: Indoor of other line connected	—	●	●	□	●	□	Other line connected during automatic address	I/F
E23	—	—	●	●	□	●	□	Standing trouble in communication between outdoor units	I/F
E25	—	—	●	●	□	●	□	Duplicated follower outdoor addresses	I/F
E26	No. of outdoor units which received signal normally	—	●	●	□	●	□	Decrease of No. of connected outdoor units	I/F
E28	Detected outdoor unit number	—	●	●	□	●	□	Follower outdoor unit trouble	I/F

Wired remote control display	Check code		Wireless remote control			Judging device			
	Outdoor 7-segment display	Auxiliary code	Sensor block display of receiving unit						
				Operation	Timer	Ready	Flash		
E31	—	—	●	●	□	●	□	IPDU communication trouble	I/F
F01	—	—	□	□	●	●	●	Indoor TCJ sensor trouble	Indoor
F02	—	—	□	□	●	●	●	Indoor TC2 sensor trouble	Indoor
F03	—	—	□	□	●	●	●	Indoor TC1 sensor trouble	Indoor
F04	—	—	□	□	○	○	○	TD1 sensor trouble	I/F
F05	—	—	□	□	○	○	○	TD2 sensor trouble	I/F
F06	—	TE1 sensor TE2 sensor	□	□	○	○	○	TE1 sensor trouble TE2 sensor trouble	I/F
F07	—	—	□	□	○	○	○	TL sensor trouble	I/F
F08	—	—	□	□	○	○	○	TO sensor trouble	I/F
F09	—	01: TG1 02: TG2	□	□	○	○	○	TG1 sensor trouble TG2 sensor trouble	I/F
F10	—	—	□	□	○	○	○	Indoor TA sensor trouble	Indoor
F11	—	TF sensor	□	□	○	○	○	TF sensor trouble	Indoor
F12	—	01: TS1 sensor 03: TS3 sensor	□	□	○	○	○	TS1 sensor trouble, TS3 sensor trouble	I/F
F13	—	01: Comp. 1 side 02: Comp. 2 side 03: Comp. 3 side	□	□	○	○	○	TH sensor trouble	IPDU
F15	—	—	□	□	○	○	○	Outdoor temp. sensor miswiring (TE1, TL)	I/F
F16	—	—	□	□	○	○	○	Outdoor pressure sensor miswiring (Pd, Ps)	I/F
F22	—	—	□	□	○	○	○	TD3 trouble	I/F
F23	—	—	□	□	○	○	○	Ps sensor trouble	I/F
F24	—	—	□	□	○	○	○	Pd sensor trouble	I/F
F29	—	—	□	□	○	○	○	Indoor other trouble	Indoor
F31	—	—	□	□	○	○	○	Indoor EEPROM trouble	I/F
H01	—	01: Comp. 1 side 02: Comp. 2 side 03: Comp. 3 side	●	●	□	●	□	Compressor break down	IPDU
H02	—	01: Comp. 1 side 02: Comp. 2 side 03: Comp. 3 side	●	●	□	●	□	Compressor trouble (lock)	IPDU
H03	—	01: Comp. 1 side 02: Comp. 2 side 03: Comp. 3 side	●	●	□	●	□	Current detect circuit system trouble	IPDU
H05	—	—	●	●	□	●	□	TD1 miswiring	I/F
H06	—	—	●	●	□	●	□	Low pressure protective operation	I/F
H07	—	—	●	●	□	●	□	Oil level down detective protection	I/F

Wired remote control display	Check code		Wireless remote control			Check code name	Judging device
	Outdoor 7-segment display	Auxiliary code	Outdoor 7-segment display	Sensor block display of receiving unit	Flash		
H08		01: TK1 sensor trouble 02: TK2 sensor trouble 03: TK3 sensor trouble 04: TK4 sensor trouble 05: TK5 sensor trouble		●	●	Oil level defective temp sensor trouble	I/F
H15				●	●	TD2 miswiring	I/F
H16		01: TK1 oil circuit system trouble 02: TK2 oil circuit system trouble 03: TK3 oil circuit system trouble 04: TK4 oil circuit system trouble 05: TK5 oil circuit system trouble		●	●	Oil level defective circuit trouble	I/F
H25				●	●	TD3 miswiring	I/F
L03				○	○	Indoor center unit duplicated	Indoor
L04				○	○	Outdoor line address duplicated	I/F
L05				●	●	Duplicated indoor units with priority (Displayed in indoor unit with priority)	I/F
L06		No. of indoor units with priority		○	○	Duplicated indoor units with priority (Displayed in unit other than indoor unit with priority)	I/F
L07				●	●	Group line in individual indoor unit	Indoor
L08				●	●	Indoor group / Address unset	Indoor, I/F
L09				●	●	Indoor capacity unset	Indoor
L10				○	○	Outdoor capacity unset	I/F
L17				○	○	Outdoor unit model mismatch trouble	I/F
L20				○	○	Duplicated central control addresses	Indoor
L28				○	○	Over No. of connected outdoor units	I/F
L29		The same as E31		●	●	No. of IPDU trouble	I/F
L30		Detected indoor address		○	○	Indoor outside interlock	Indoor
L31				—	—	Extended I/C trouble	I/F
P01				●	●	Indoor fan motor trouble	Indoor
P03				●	●	Discharge temp. TD1 trouble	I/F
P04		01: Comp. 1 side 02: Comp. 2 side 03: Comp. 3 side		●	●	High-pressure SW system operation	IPDU
P05		00: Detected phase loss		○	○	Phase loss trouble / interruption of power supply	I/F
P07				○	○	Inverter DC voltage (Vdc) trouble	I/F
P10		Detected indoor address		●	●	Heat sink overheat trouble	IPDU, I/F
P12				●	●	Indoor overflow trouble	Indoor
P13				●	●	Indoor fan motor trouble or duct setting miss	Indoor
P15		01: TS condition 02: TD condition		●	●	Outdoor liquid back detection trouble	I/F
P17				○	○	Gas leak detection	I/F
P18				○	○	Discharge temp. TD2 trouble	I/F
P19		Detected outdoor unit number		○	○	Discharge temp. TD3 trouble	I/F
P20				○	○	4-way valve inverse trouble	I/F
P22		0*: IGBT circuit 1*: Location detection circuit trouble 3*: Motor lock-up trouble 4*: Abnormal temperature detected C*: Abnormal temperature was detected by the TH sensor. D*: TH sensor trouble E*: Inverter DC voltage trouble (outdoor unit fan) Caution) Although letters O to F appear at locations indicated by "*", please ignore them.		○	○	High-pressure protective operation	I/F
P26		01: Comp. 1 side 02: Comp. 2 side 03: Comp. 3 side		○	○	Outdoor fan IPDU trouble	IPDU
P26				○	○	G-TR short protection trouble	IPDU

Wired remote control display	Check code		Wireless remote control			Check code name	Judging device
	Outdoor 7-segment display	Auxiliary code	Outdoor 7-segment display	Sensor block display of receiving unit	Flash		
P29		01: Comp. 1 side 02: Comp. 2 side 03: Comp. 3 side		○	○	Comp position defective circuit system trouble	IPDU
P31				○	○	Other indoor unit trouble (Group follower unit trouble)	Indoor

Trouble detected by TCC-LINK central control device

Wired remote control display	Check code		Wireless remote control			Check code name	Judging device
	Outdoor 7-segment display	Auxiliary code	Outdoor 7-segment display	Sensor block display of receiving unit	Flash		
C05				—	—	Sending trouble in TCC-LINK central control device	TCC-LINK
C06				—	—	Receiving trouble in TCC-LINK central control device	TCC-LINK
C12				—	—	Batch alarm of general-purpose equipment control interface	General-purpose equipment I/F
P30				—	—	Group control branching unit trouble (L20 is displayed)	TCC-LINK

TCC-LINK: TOSHIBA Carrier Communication Link.

13. DETACHMENTS

WARNING

Before replacement of the parts, be sure to stop operation of the air conditioner and turn off switch of the breaker.

CAUTION

Be sure to put on the gloves at disassembling work; otherwise an injury will be caused by a part, etc.

1 Remove the electric parts box cover.

Remove the M4 screws.

Electric parts box cover

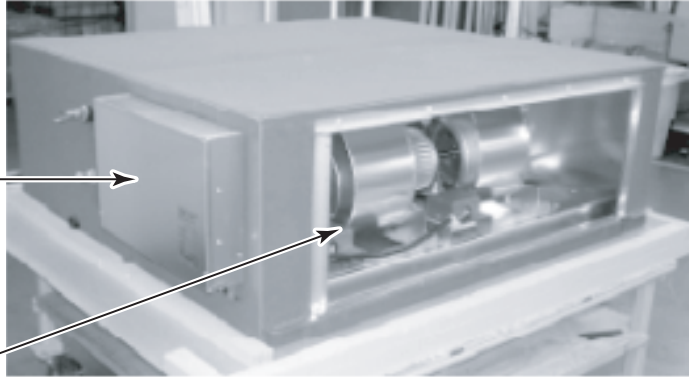

Fan assembly

- 1) The model in the left photo is AP0721, AP0961 types.
- 2) The one fan is provided to AP0481 type, two are provided to AP0721, AP0961 types, respectively.
AP0481 type has the same configuration as AP0721, AP0961 types.

Remove the electric parts box cover.



2 Remove lead wires of the fan motor connected to the terminal block inside of the electric parts box.

One fan motor to AP0481 type, two fan motors to AP0721 / AP0961 type are provided.
(Photo: AP0961 type)

Cut binding tie.

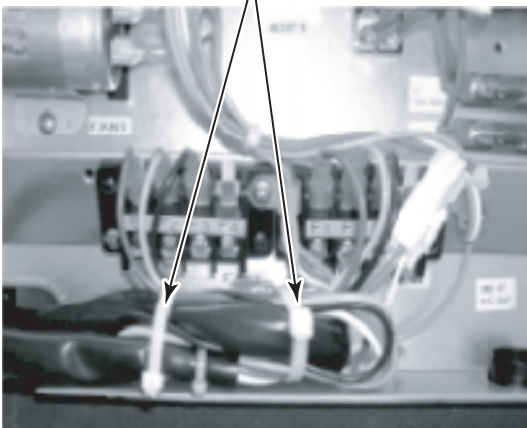

Remove Faston terminals of which wire color are blue (1), orange (2), black (3) in the fan motor lead wires.

Remove the white and blue connectors.

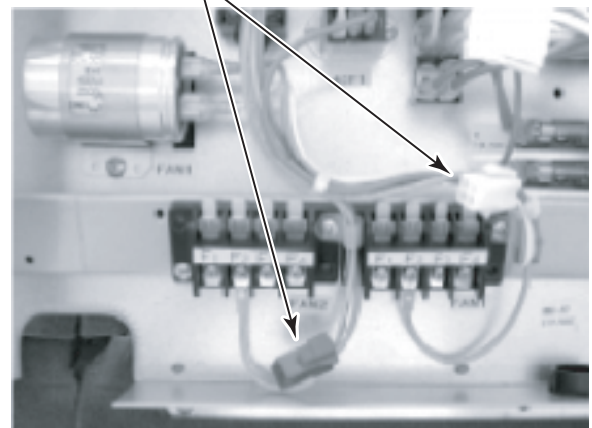

Status which tie wrap binding wire removed.

3 Remove the M5 screws from the cabinet and then put them on the electric parts box.

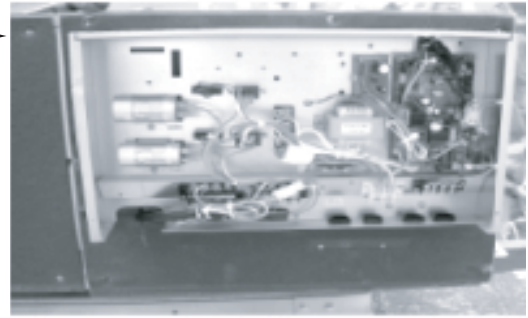
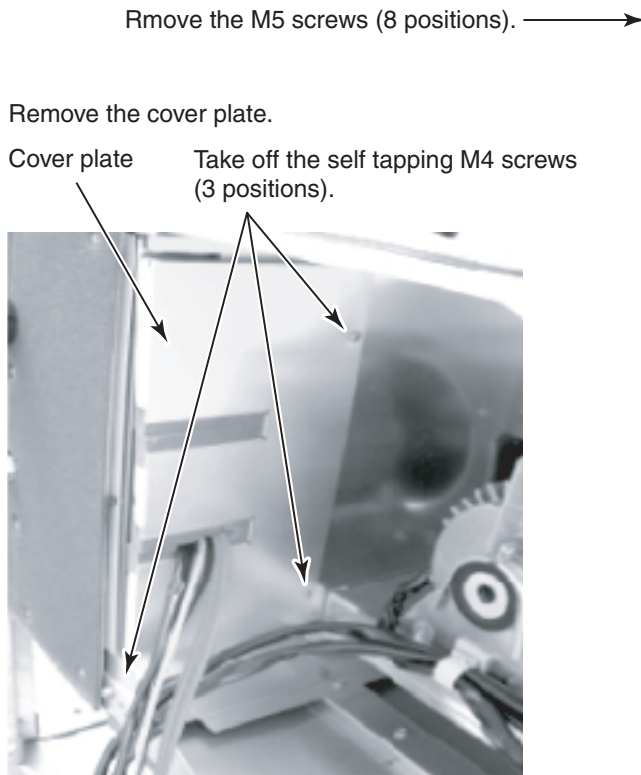

Removed status



4 Pull out the fan toward you.

Remove the self tapping M4 screws (3 positions).

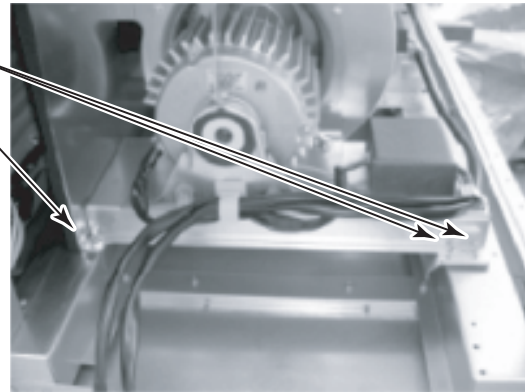

Status which all the fan assembly are pulled out.

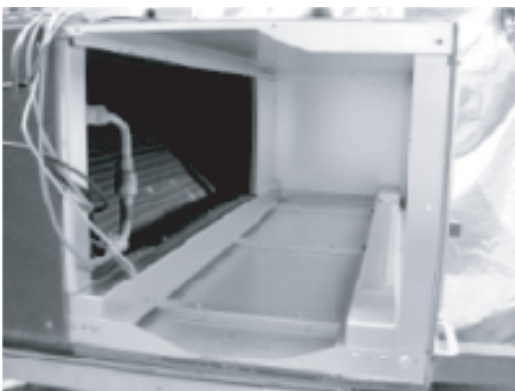

Pull out the fan toward you.

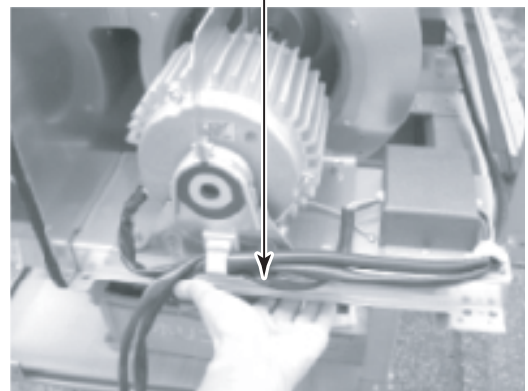

5 Remove the fan assembly from the air intake unit.

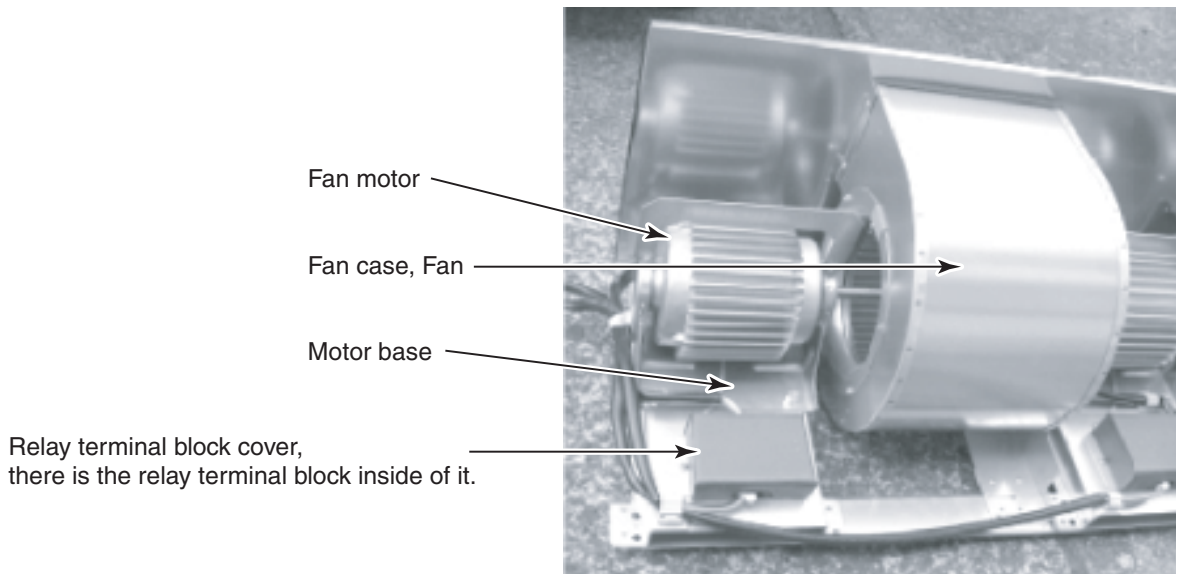

6 Replacement of fan and fan motor

Remove the relay terminal block cover.

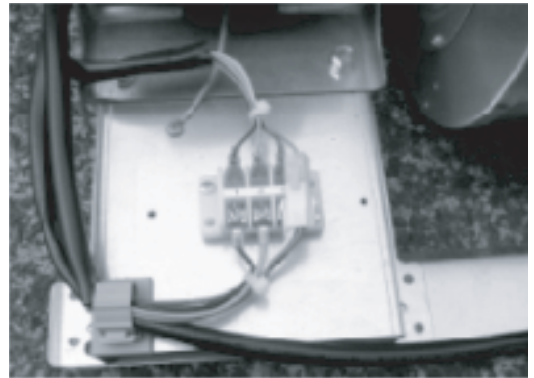

Remove the ground screw.



Remove the connector and Faston terminal.



7 Remove the fan motor assembly from the fan assembly.

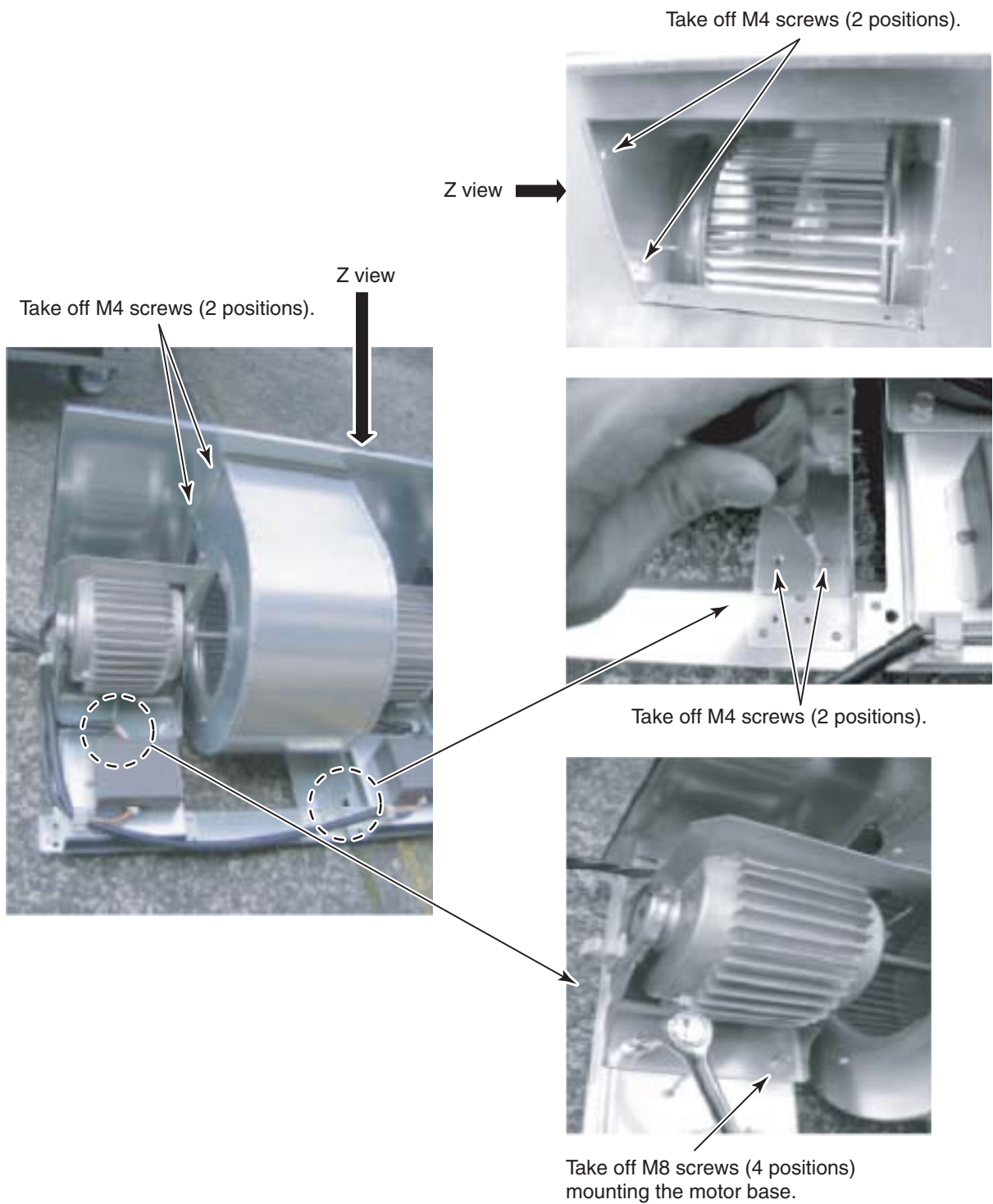

8 Remove parts to be replaced from the fan motor assembly.

Take off M4 screws (4 positions) from the bell mouth.

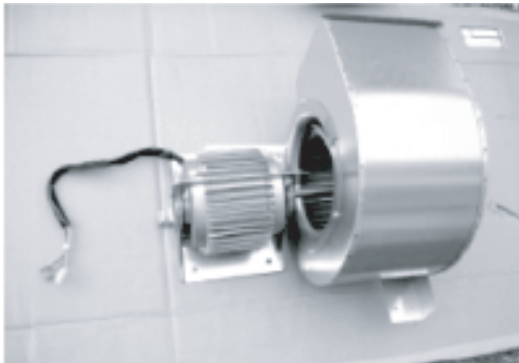

Loosen the setscrews.

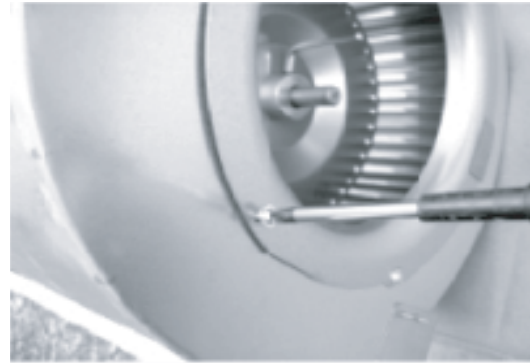

Remove the fan



When replacing the fan motor, set it so that the model name label directs upward.

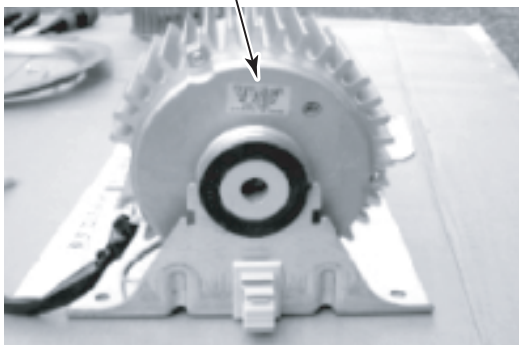

Replace the fan motor with a new one.

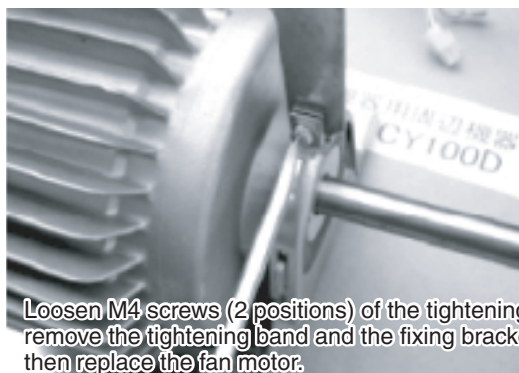
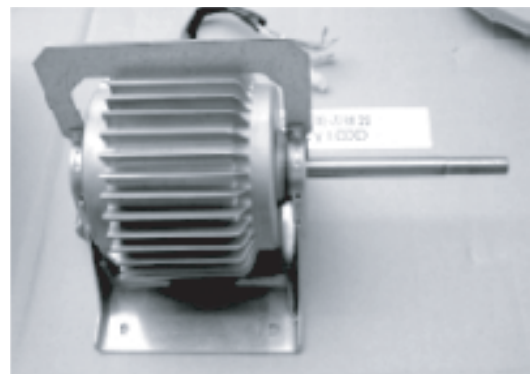
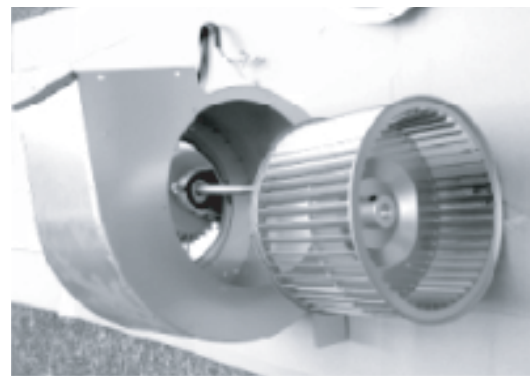

Loosen M4 screws (2 positions) of the tightening band, remove the tightening band and the fixing bracket and then replace the fan motor.

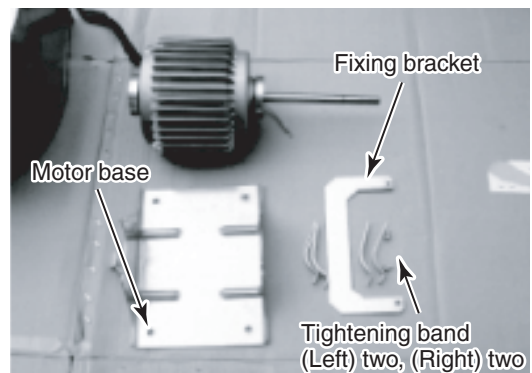

Fixing bracket

Motor base

Tightening band (Left) two, (Right) two

After replacement, assemble the fan in reverse procedure so that the assembly becomes the same status before replacement. Be sure there is no looseness of screws in assembling time. Check that the air blows off and the fan does not hit with the fan case, and also check there is no abnormal noise.

14. P. C. BOARD EXCHANGE PROCEDURES

■ Indoor unit

14-1. Replacement of indoor P.C. board

Part code	Model type	P.C. board type
431-6V-588	MMD-AP***HF2UL series	MCC-1403

< Set the type code and capacity code and then set DN [C8] = [0001] >

Points to note when replacing indoor P.C. board assembly

The electrically erasable programmable read-only memory (hereinafter EEPROM, IC010) mounted on an indoor P.C. board holds important setting data, including the type and capacity codes intrinsic to the model (set at the factory), as well as the line / indoor / group addresses, high ceiling adjustment setting and the like (during installation, either automatically or manually). Proceed with the replacement of an indoor P.C. board assembly in accordance with the procedure described below.

After completion of the work, check the settings again, including the indoor unit No. and group header / follower designation, and confirm the integrity of the refrigerating cycle by conducting a test operation, etc.

<Replacement procedure>

Method 1

If it is possible to turn on the indoor unit and read the setting data from the P.C. board to be replaced via a wired remote control -

Reading EEPROM data: **Procedure 1**



Replacing P.C. board and turning on power: **Procedure 2**



Writing EEPROM data in new EEPROM: **Procedure 3**



Resetting power supply (applicable to all indoor units connected to remote control in case of group operation)

Method 2

If it is not possible to read the setting data due to the failure of the EEPROM itself -

Replacing P.C. board and turning on power: **Procedure 2**



Writing EEPROM data on basis of information supplied by customer (e.g. high ceiling adjustment setting and optional connection setting): **Procedure 3**



Resetting power supply (applicable to all indoor units connected to remote control in case of group operation)

Procedure 1: reading setting data from EEPROM

(Read the setting data from EEPROM, including both the factory settings and any modifications made to them on site.)

- 1** Push the + + buttons simultaneously and hold for at least 4 seconds. (This number corresponds to the same number shown on the Remote Control Operation Diagram.)
 - * In the case of group control, the unit No. displayed first is the indoor unit No. of the header unit.
 - At the same time, the CODE No. (DN code) is displayed, and the fan of the selected indoor unit comes on, with the louver swinging, depending on the model.
- 2** Each time the button (button of left side) is pushed, one of the indoor unit No. under group control is displayed in turn.
 - * The fan of the selected indoor unit comes on, with the louvers swinging, depending on the model.
- 3** The button allows you to move the CODE No. (DN code) up / down by one place.
- 4** First, change the CODE No. (DN code) from to !. (To set filter sign lighting time)
Jot down the setting data displayed.
- 5** Change the CODE No. (DN code) using the button.
Again, jot down the setting data displayed.
- 6** Repeat step 5 until all the setting data has been jotted down. (See the CODE No. list.)
 - * CODE No. (DN code) go from ! to FF with a few gaps along the way.
- 7** When finished, push the button to bring the system back to normal off state.
(It takes the system about 1 minute to become responsive to remote control operation.)

DN	Contents
10	Type
11	Indoor unit capacity
12	Line address
13	Indoor address
14	Group address

The type and capacity of the indoor unit are necessary for fan speed setting.

Remote control operation diagram

<Fig. 1 RBC-AMT32UL>

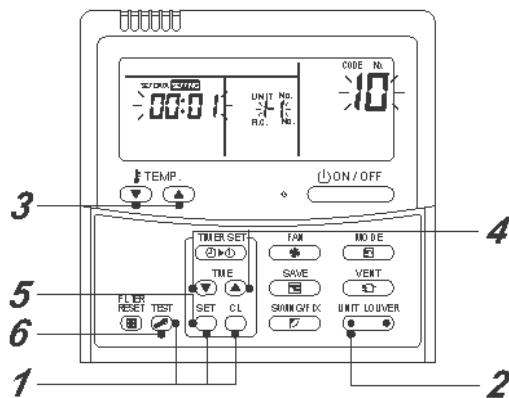

Procedure 2: replacing P.C. board

1 Replace the faulty P.C. board with a service P.C. board.

Be sure to replicate the old jumper setting (removal), and connector short-circuit setting (e.g. CN34) on the service P.C. board. (See the diagram at below.)

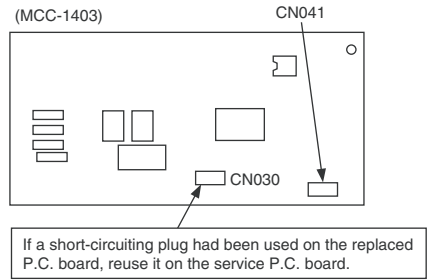

2 It is necessary to establish a one-to-one correspondence between the indoor unit being serviced and the remote control.

Turn on the indoor unit using one of the methods described below according to the system configuration.

- (1) Single (stand-alone) operation
Turn on the indoor unit and proceed to **Procedure 3**.
- (2) Group operation
 - A) If it is possible to selectively turn on the indoor unit being serviced
Turn on the indoor unit being serviced and proceed to **Procedure 3**.
 - B) If it is not possible to selectively turn on the indoor unit being serviced (**Case 1**)
 - a) Temporarily disconnect the group control wiring from terminals A and B of the indoor unit being serviced.
 - b) Connect the remote control wiring to the terminals, turn on the indoor unit, and proceed to **Procedure 3**.
- * If this method cannot be used, proceed to the alternative method described below (**Case 2**).
- C) If it is not possible to selectively turn on the indoor unit being serviced (**Case 2**)
 - a) Remove the CN041 connectors of all other indoor units in the same group.
 - b) Turn on the indoor unit and proceed to **Procedure 3**.

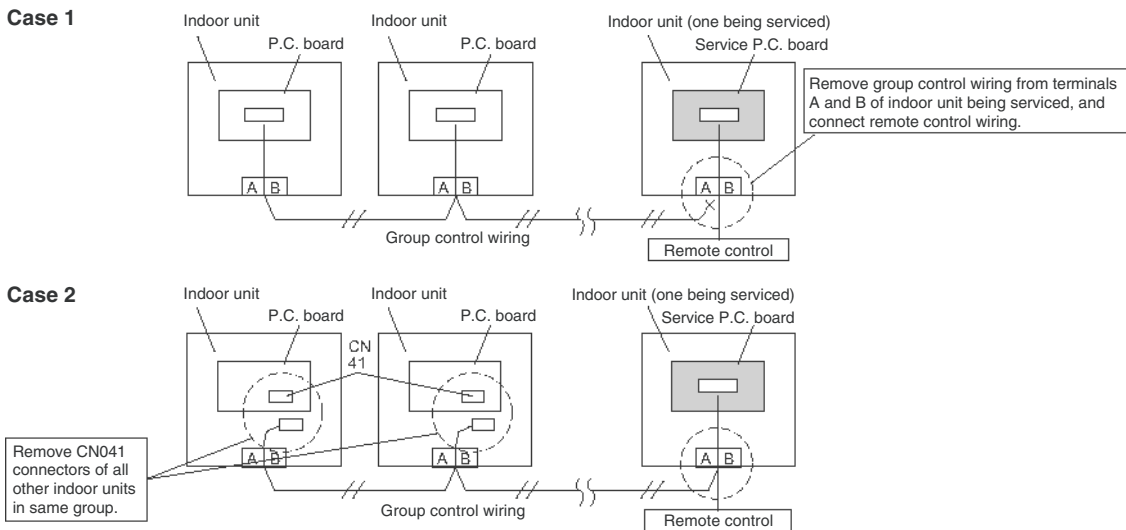

* Be sure to restore the temporarily removed group control wiring and CN041 connectors to their initial states after Procedure 3 has been completed.

Procedure 3: writing setting data in EEPROM

(The EEPROM of the service P.C. board has been set to the factory default values.)

- 1** Push the + + buttons simultaneously and hold for at least 4 seconds. (This number corresponds to the same number shown on the Remote Control Operation Diagram.)

(Under UNIT No., ALL is displayed.)

At the same time, the CODE No. (DN code) is displayed, and the fan of the indoor unit comes on, with the louver swinging, depending on the model.

<Fig. 1 RBC-AMT32UL>

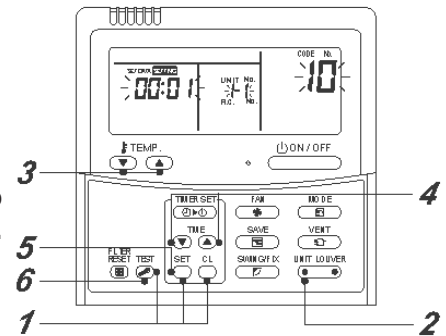

- 2** Push the left part of the button (button of left side) to display the indoor unit No. one by one in the group control. Specify the indoor unit No. whose service PC board was replaced. (This operation is not available if the UNIT No. shows ALL.)

- 3** The button allows you to moved the CODE No. (DN code) up / down by one place.

- 4** First, set the type and capacity codes of the indoor unit.

(Changing the type and capacity codes in EEPROM overwrites the factory default settings.)

- (1) Set the CODE No. (DN code) to (no change)
- (2) Use the button to select the type. (For example, is for the 4-way cassette type.) - See the CODE No. list.
- (3) Push the button. (The display should change from flashing to steady.)
- (4) Use the button to set the CODE No. (DN code) to .
- (5) Use the button to set the capacity code. (For example, is for the 027 type.) - See the CODE No. list.
- (6) Push the button. (The display should change from flashing to steady.)

Be sure to perform the following setting.

- (7) Use the buttons set to the CODE No. (DN code) to .
- (8) Use the buttons set to the .
- (9) Push the button. (The display should change from flashing to steady.)
- (10) Push the button to bring the system back to normal off state.

- 5** Next, write any setting changes made on-site after installation, such as address settings, in the EEPROM. Perform the tasks specified in step 1 again.

- 6** Use the button to set the CODE No. (DN code) to (To set filter sign lighting time)

- 7** Check the value displayed with the value jotted down in Procedure 1 and information proved by the customer.

- (1) If there is a discrepancy, change the setting in accordance with the jotted-down value, and push the button. (The display should change from flashing to steady.)
- (2) If there is no discrepancy, do nothing.

- 8** Use the button to change the CODE No. (DN code).

Again, check the value, and change the setting if necessary.

- 9** Repeat steps 6 and 7 until all the settings are checked.

- 10** When finished, push the button to bring the system back to normal off state.

In the case of group operation, turn the unit off, reconnect the indoor-indoor group control wiring and CN041 connectors, and turn on all the indoor units.

(It takes the system about 1 minute to become responsive to remote control operation.)

* CODE No. (DN code) go from to FF with a few gaps along the way.

If you realize you have wrongly corrected a certain setting after pushing the button, you can recover the initial value by pushing the button, provided that the CODE No. (DN code) is yet to be changed.

Table
CODE No. table (Please record the objective unit data at field)

DN	Item	Memo	At shipment
01	Filter sign lighting time		0002: 2500 hour
02	Dirty state of filter		0000: Standard
03	Central control address		0099: Unfixed
06	Heating suction temp shift		0002: +3.6°F (+2°C)
0C	PRE-DEF indication selection		0000: Standard
0F	Cooling only		0000: Heat pump
10	Type		According to model type
11	Indoor unit capacity (See below table)		According to capacity type
12	Refrigerant line address		0099: Unfixed
13	Indoor unit address		0099: Unfixed
14	Group address		0099: Unfixed
28	Automatic restart from power cut		0001: Available
2A	Option input selection (CN080)		0002: External emergency input
2b	Thermo output selection (T10)		0000: Thermo ON
2E	HA terminal (T10) selection		0000: Available (HA terminal)
32	Sensor selection		0000: Available
60	Timer set (Wired remote control)		0000: Available
72	Fan OFF in defrosting time		0001: To OFF

Type (CODE No. [10])

Setup data	Type	Model abb. name
0001*	Invalid	—
0016	Outside Air Unit	MMD-AP***HF2UL

Indoor unit capacity (CODE No.[11])

Setup data	Model
0001*	Invalid
0017	048 type
0021	072 type
0023	096 type

* Initial value EEPROM installed on supplied service P.C. board.

15. EXPLODED VIEWS AND PARTS LIST

MMD-AP0481HF2UL

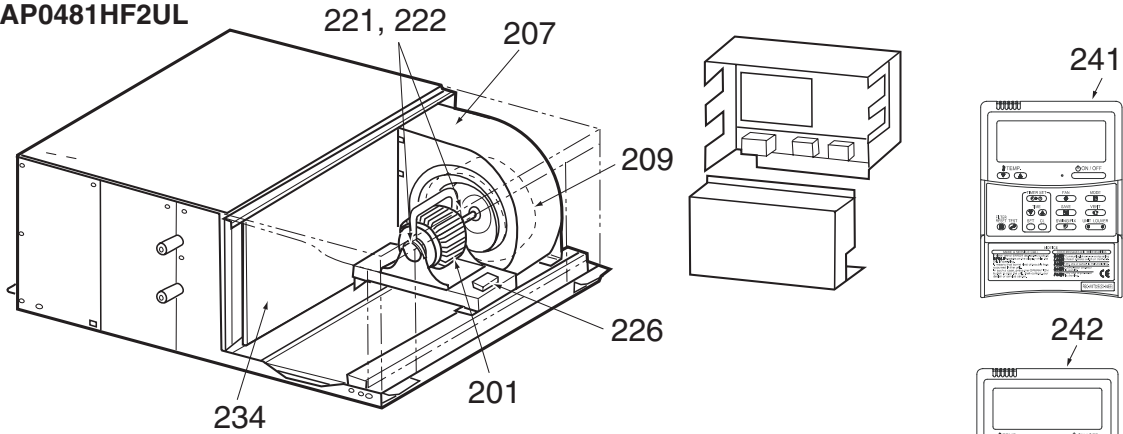

**MMD-AP0721HF2UL,
MMD-AP0961HF2UL**

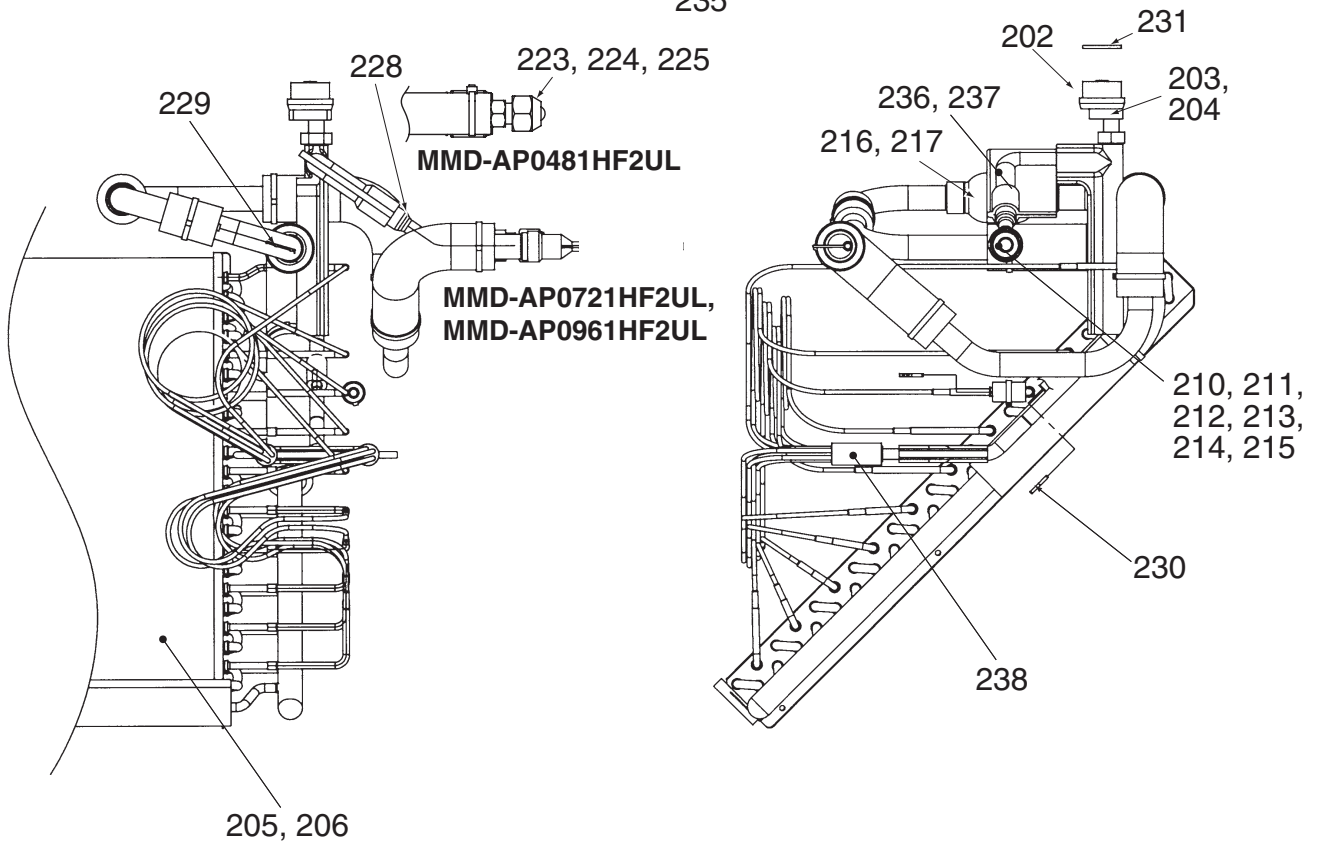
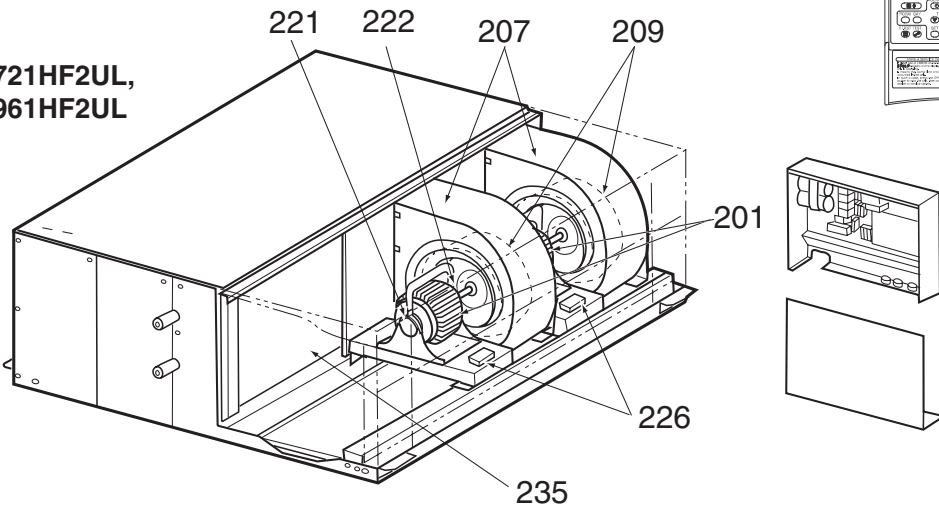

Location No.	Part No.	Description	Q'ty/Set MMD-		
			AP0481HF2UL	AP0721HF2UL	AP0961HF2UL
201	4312C154	MOTOR, FAN, STF-200-160U4A	1	2	2
202	43146707	MOTOR, PMV, EDM-MD12TF-3	1	1	1
203	43146723	BODY, PMV	1		
204	43146729	BODY, PMV		1	1
205	4314J373	EVAPORATOR ASSY	1		
206	4314J374	EVAPORATOR ASSY		1	1
207	43122109	CASE, FAN	1	2	2
209	43020352	FAN	1	2	2
210	43149355	NUT, FLARE, 3/8 IN	1		
211	43049776	SOCKET, 3/8 IN	1		
212	43F47609	BONNET, 3/8 IN	1		
213	43047688	NUT, FLARE, 1/2, IN		1	1
214	43149332	SOCKET		1	1
215	43147195	BONNET, 1/2 IN		1	1
216	4314Q053	STRAINER, DIA21	1		
217	4314Q052	STRAINER, DIA45		1	1
221	43139154	BAND, MOTOR, LEFT	2	4	4
222	43139155	BAND, MOTOR, RIGHT	2	4	4
223	43149352	NUT, FLARE, 5/8, IN	1		
224	43149354	SOCKET, 5/8 IN	1		
225	43194029	BONNET, 5/8 IN	1		
226	43160549	TERMINAL BLOCK, JX0-3B	1	2	2
227	431S8064	OWNER'S MANUAL	1	1	1
228	43147649	STRAINER	1	1	1
229	43107215	HOLDER, SENSOR	1	1	1
230	43F19904	HOLDER, SENSOR (TS)	2	2	2
231	43149314	SHEET, PMV	1	1	1
234	43172200	PAN ASSY, DRAIN	1		
235	43172199	PAN ASSY, DRAIN		1	1
236	4314Q067	PIPE ASSY, LIQUID	1		
237	4314Q066	PIPE ASSY, LIQUID		1	1
238	43147706	DISTRIBUTOR	1	1	1
241	43166013	REMOTE CONTROLLER, SX-TA01UE	1	1	1
242	43166014	REMOTE CONTROLLER, SX-TB01UE	1	1	1

Electrical parts

MMD-AP0481HF2UL

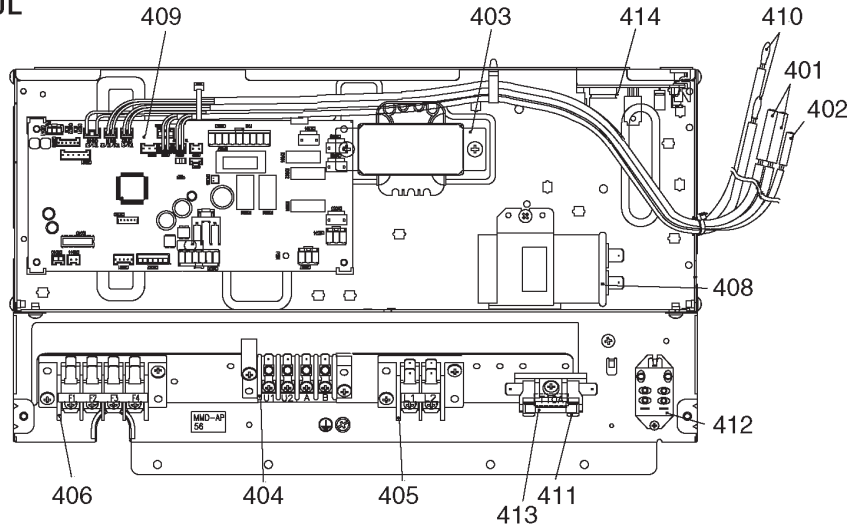

MMD-AP0721HF2UL, MMD-AP0961HF2UL

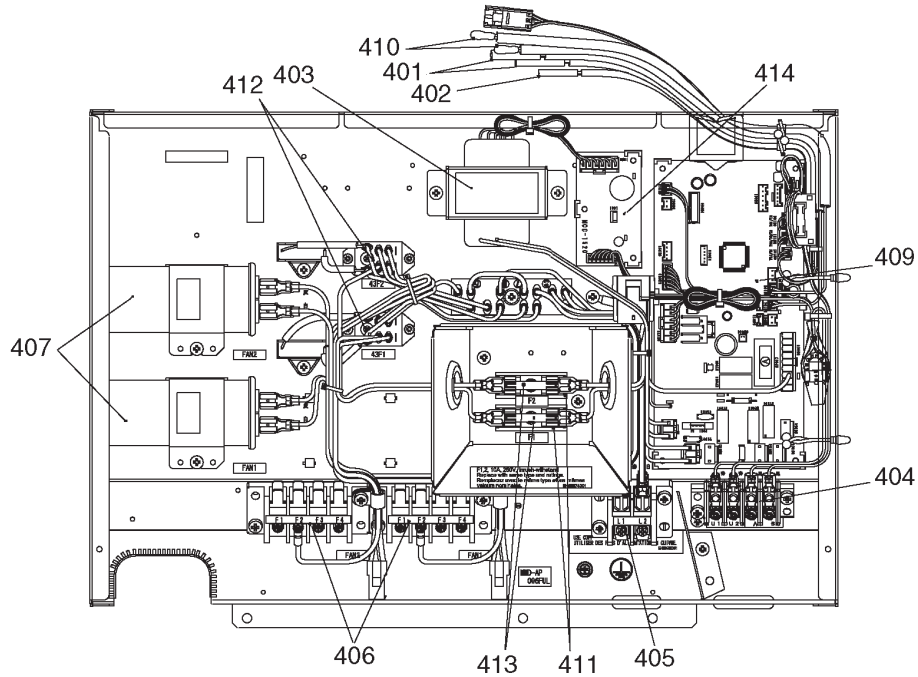

Location No.	Part No.	Description	Q'ty/Set MMD-		
			AP0481HF2UL	AP0721HF2UL	AP0961HF2UL
401	43050425	SENSOR ASSY, SERVICE, TC (F6) : TC2, TCJ	2	2	2
402	43150320	SENSOR, SERVICE, TG (F4) : TC1	1	1	1
403	43158182	TRANSFORMER, TT-12	1	1	1
404	43160574	TERMINAL, 4P	1	1	1
405	43160626	TERMINAL BLOCK, 2P, 20A	1	1	1
406	43160554	TERMINAL BLOCK, 4P, 20A	1	2	2
407	43155208	CAPACITOR, 500V, 4UF		2	2
408	43155212	CAPACITOR, 400V, 8MF	1		
409	4316V588	PC BOARD ASSY, MCC-1403	1	1	1
410	43F50426	SENSOR, SERVICE, TA	2	2	2
411	43060859	FUSE BLOCK, 30A, 250V	1	2	2
412	43154173	RELAY, LY2F-L, AC230V	1	2	2
413	43160637	FUSE, 10A	1	2	2
414	4316V345	P. C. BOARD ASSEMBLY, MCC-1520	1	1	1

WARNINGS ON REFRIGERANT LEAKAGE

Important

Check of Concentration Limit

The room in which the air conditioner is to be installed requires a design that in the event of refrigerant gas leaking out, its concentration will not exceed a set limit.

The refrigerant R410A which is used in the air conditioner is safe, without the toxicity or combustibility of ammonia, and is not restricted by laws to be imposed which protect the ozone layer. However, since it contains more than air, it poses the risk of suffocation if its concentration should rise excessively. Suffocation from leakage of R410A is almost non-existent. With the recent increase in the number of high concentration buildings, however, the installation of multi air conditioner systems is on the increase because of the need for effective use of floor space, individual control, energy conservation by curtailing heat and carrying power etc.

Most importantly, the multi air conditioner system is able to replenish a large amount of refrigerant compared with conventional individual air conditioners. If a single unit of the multi conditioner system is to be installed in a small room, select a suitable model and installation procedure so that if the refrigerant accidentally leaks out, its concentration does not reach the limit (and in the event of an emergency, measures can be made before injury can occur).

In a room where the concentration may exceed the limit, create an opening with adjacent rooms, or install mechanical ventilation combined with a gas leak detection device.

The concentration is as given below.

$$\frac{\text{Total amount of refrigerant (lbs (kg))}}{\text{Min. volume of the indoor unit installed room (ft}^3 \text{ (m}^3\text{))}} \leq \text{Concentration limit (lbs/ft}^3 \text{ (kg/m}^3\text{))}$$

The concentration limit of R410A which is used in multi air conditioners is 0.019 lbs/ft³ (0.3kg/m³).

NOTE 1 :

If there are 2 or more refrigerating systems in a single refrigerating device, the amounts of refrigerant should be as charged in each independent device.

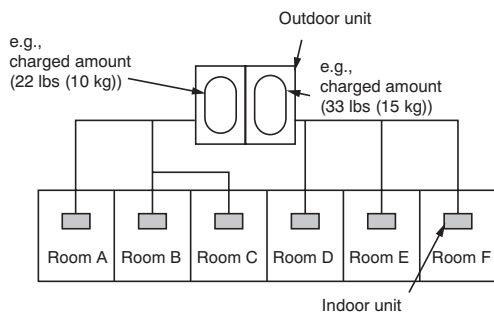

For the amount of charge in this example:

The possible amount of leaked refrigerant gas in rooms A, B and C is 22 lbs (10kg).
The possible amount of leaked refrigerant gas in rooms D, E and F is 33 lbs (15kg).

NOTE 2 :

The standards for minimum room volume are as follows.

- 1) No partition (shaded portion)

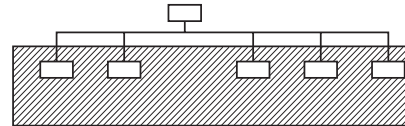

- 2) When there is an effective opening with the adjacent room for ventilation of leaking refrigerant gas (opening without a door, or an opening 0.15% or larger than the respective floor spaces at the top or bottom of the door).

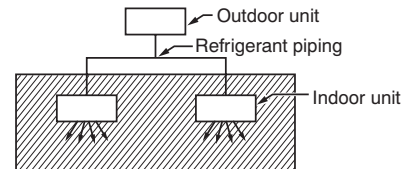

- 3) If an indoor unit is installed in each partitioned room and the refrigerant piping is interconnected, the smallest room of course becomes the object. But when a mechanical ventilation is installed interlocked with a gas leakage detector in the smallest room where the density limit is exceeded, the volume of the next smallest room becomes the object.

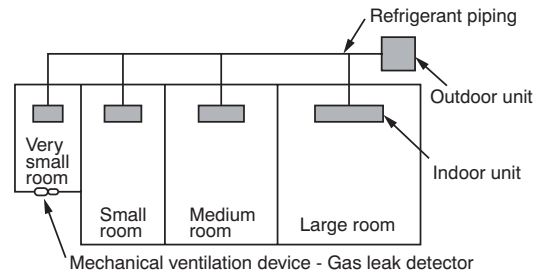

NOTE 3 :

The minimum indoor floor area compared with the amount of refrigerant is roughly as follows:
(When the ceiling is 8.9 ft (2.7 m) high)

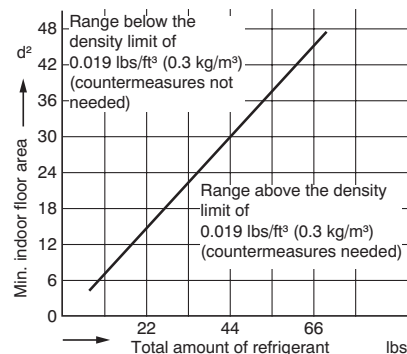

TOSHIBA CARRIER CORPORATION

72-34 Horikawa-cho, Saiwai-ku, Kawasaki-shi, Kanagawa 212-8585, JAPAN

Copyright © 2017 TOSHIBA CARRIER CORPORATION, ALL Rights Reserved.

Revision record

First issue	—	—	Mar., 2016
Revision 1	English was corrected.	Page 3, 4, 5, 6, 22, 23, 25, 39, 40, 41, 43, 45, 46, 50, 51, 52, 54, 62	Sep., 2016
Revision 2	The contents change of Description of service parts	Page 111	Jun., 2017

Free Manuals Download Website

<http://myh66.com>

<http://usermanuals.us>

<http://www.somanuals.com>

<http://www.4manuals.cc>

<http://www.manual-lib.com>

<http://www.404manual.com>

<http://www.luxmanual.com>

<http://aubethermostatmanual.com>

Golf course search by state

<http://golfingnear.com>

Email search by domain

<http://emailbydomain.com>

Auto manuals search

<http://auto.somanuals.com>

TV manuals search

<http://tv.somanuals.com>