

Honeywell

V5155 GAS VALVES ARE USED ON ROOM HEATERS, WALL FURNACES, DUCT HEATERS, AND HOT WATER BOILERS.

□ The temperature sensing element is a liquid-filled bulb. It is installed in the return or discharge airstream on room heaters, wall furnaces, and duct heaters.

□ Well or pressure fitting required for hot water boiler applications.

□ The V5155A snaps open to minimum flame condition, then modulates between minimum and maximum flame in proportion to the demand for heat. Minimum rate valve snaps closed if minimum flame exceeds heat load.

□ The V5155B provides similar modulation, but does not include the minimum rate valve and does not fully close. A second valve is used to shut off the burner when the demand for heat is satisfied.

THERMOSTATIC GAS VALVES

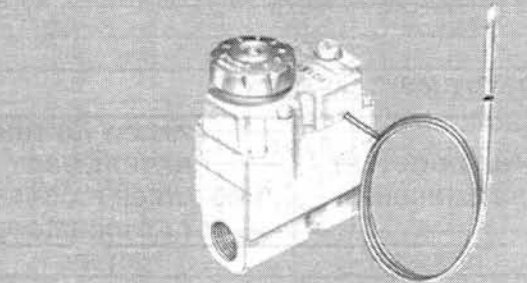

3/8 X 3/8, 1/2 X 1/2 NPT

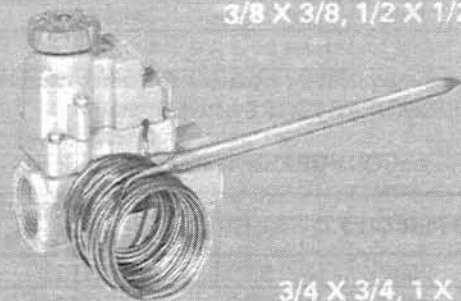

3/4 X 3/4, 1 X 1 NPT

V5155A,B

SPECIFICATIONS

TRADELINE MODELS

Tradeline models are selected and packaged to provide ease of stocking, ease of handling, and maximum replacement value. Tradeline models specifications are the same as those of standard models except as noted below.

MODELS	INLET-OUTLET SIZE	CAPILLARY LENGTH		TEMPERATURE RANGE	
		INCHES	METRES	F	C
V5155A1482	1/2 x 1/2 NPT Valve with (2) 1/2 x 3/8 NPT adapters	36	0.9	60-100	16- 38
V5155A2217	1 x 1 NPT Valve with (2) 1 x 3/4 NPT adapters	138	3.5	60-100	16- 38
V5155A2225				75-200	24- 93
V5155A2233				120-240	49-116

ADDITIONAL FEATURES: Tradeline pack with cross reference label and special instruction sheet.

STANDARD MODELS

MODELS:

V5155B modulating (low to high flame, no burner off).

VALVE (GAS) CAPACITY:

INLET-OUTLET SIZE (INCHES)	CAPACITY (BTUH) NATURAL GAS 1000 BTU/CU FT, 0.64 SP GR AT 1.0 INCH WC PD
3/8 x 3/8	201,660
1/2 x 1/2	252,390
3/4 x 3/4	388,000
1 X 1	485,000

To find the equivalent capacity for other gases, use the CONVERSION FACTORS listed below.

CONVERSION FACTORS

BTU PER CU FT	SP GR	MULTIPLY LISTED CAPACITY BY
500	0.60	0.516
800	0.70	0.765
2,500	1.53	1.62

TYPE OF GAS: Suitable for all gases.

VALVE PATTERN: Straight-through.

PRESSURE RATING: 1/2 psig maximum.

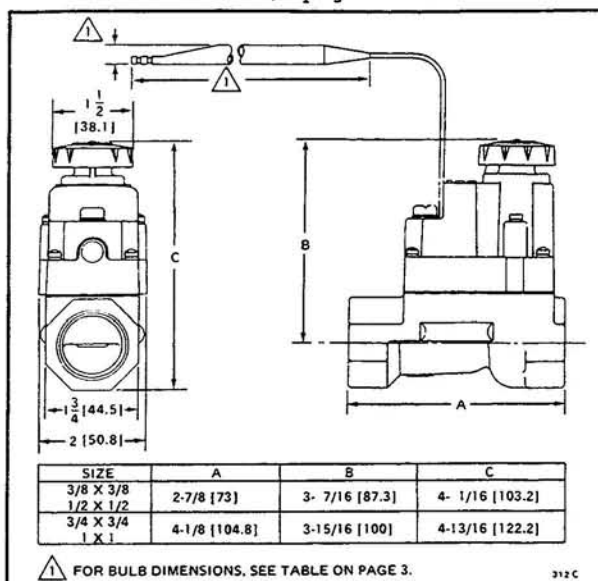

FIG. 1—V5155A AND B DIMENSIONS, IN INCHES [MILLIMETRES SHOWN IN BRACKETS].

(continued on page 3)

ORDERING INFORMATION

WHEN PURCHASING REPLACEMENT AND MODERNIZATION PRODUCTS FROM YOUR TRADELINE WHOLESALER OR YOUR DISTRIBUTOR, REFER TO THE TRADELINE CATALOG OR PRICE SHEETS FOR COMPLETE ORDERING NUMBER.

SPECIFY—

1. ORDER NUMBER.
2. VALVE SIZE.
3. TEMPERATURE RANGE.
4. CAPILLARY LENGTH.
5. ACCESSORIES, IF REQUIRED.

IF YOU HAVE ADDITIONAL QUESTIONS, NEED FURTHER INFORMATION, OR WOULD LIKE TO COMMENT ON OUR PRODUCTS OR SERVICES, PLEASE WRITE OR PHONE:

1. YOUR LOCAL HONEYWELL RESIDENTIAL DIVISION SALES OFFICE (CHECK WHITE PAGES OF PHONE DIRECTORY).

2. RESIDENTIAL DIVISION CUSTOMER SERVICE
HONEYWELL INC., 1885 DOUGLAS DRIVE NORTH
MINNEAPOLIS, MINNESOTA 55422 (612) 542-7500

(IN CANADA—HONEYWELL CONTROLS LIMITED, 740 ELLESMERE ROAD, SCARBOROUGH, ONTARIO M1P 2V9)
INTERNATIONAL SALES AND SERVICE OFFICES IN ALL PRINCIPAL CITIES OF THE WORLD.

MINIMUM RATE: Adjustable.
 MAXIMUM RECOMMENDED AMBIENT TEMPERATURE: 125 F [52 C].

TEMPERATURE SETTING MEANS: Dial, numbered 1 through 9.

TEMPERATURE RANGES, CAPILLARY AND BULB LENGTHS:

V5155A Modusnap Valve—

VALVE SIZE (INCHES)	TEMP. RANGE		CAPILLARY LENGTH		BULB LENGTH		BULB O.D.	
	F	C	INCHES	METRES	IN.	MM	IN.	MM
3/8 x 3/8	60-100	16-38	36	0.9	11.0	279.5	1/4	6.5
	40-160	4-71	72	1.8	3.0	76.0	5/16	8.0
1/2 x 1/2	60-100	16-38	36, 96, 138	0.9, 2.4, 3.5	11.0	279.5	1/4	6.5
	120-240	49-116	54, 72, 96	1.3, 1.8, 2.4	3.0	76.0	5/16	8.0
3/4 x 3/4	40-160	4-71	72	1.8	3.5	89.0	3/8	9.5
	60-100	16-38	138	3.5	9.0	228.5	3/8	9.5
	75-200	24-93	138	3.5	3.5	89.0	3/8	9.5
	120-240	49-116	54, 72, 96	1.3, 1.8, 2.4	3.5	89.0	3/8	9.5
1 x 1	60-100	16-38	96, 138	2.4, 3.5	9.0	228.5	3/8	9.5
	65-190	18-88	36	0.9	3.5	89.0	3/8	9.5
	75-200	24-93	138	3.5	3.5	89.0	3/8	9.5
	85-210	29-99	54, 96	1.3, 2.4	3.5	89.0	3/8	9.5
	110-170	43-77	54, 96	1.3, 2.4	4.3	108.5	3/8	9.5
	120-240	49-116	54, 96, 138	1.3, 2.4, 3.5	3.5	89.0	3/8	9.5
	150-210	66-99	54, 96	1.3, 2.4	4.3	108.5	3/8	9.5

V5155B Modulating Valve—

3/4 x 3/4	40-160	4-71	72	1.8	3.5	89.0	3/8	9.5
	60-180	16-82	72	1.8	3.5	89.0	3/8	9.5
	120-240	49-116	72	1.8	3.5	89.0	3/8	9.5
1 x 1	60-180	16-82	72	1.8	3.5	89.0	3/8	9.5

DIAL SETTINGS (F, nominal):

TEMP. RANGE	DIAL NUMBER								
	1	2	3	4	5	6	7	8	9+
40 to 160	40	55	70	85	100	115	130	145	160+
60 to 100	60	65	70	75	80	85	90	95	100+
60 to 180	60	75	90	105	120	135	150	165	180+
65 to 190	65	81	96	112	128	143	159	174	190+
75 to 200	75	91	106	122	138	153	169	184	200+
85 to 210	85	101	116	132	148	163	179	194	210+
110 to 170	110	118	125	133	140	148	155	163	170+
120 to 240	120	135	150	165	180	195	210	225	240+
150 to 210	150	158	165	173	180	188	195	203	210+

DIAL SETTINGS (C, nominal):

TEMP. RANGE	DIAL NUMBER								
	1	2	3	4	5	6	7	8	9+
4 to 71	4	12	21	29	38	46	54	63	71+
16 to 38	16	19	22	24	27	30	33	35	38+
16 to 82	16	24	33	41	49	57	66	74	82+
18 to 88	18	27	36	44	53	62	71	79	88+
24 to 93	24	33	41	50	59	67	76	84	93+
29 to 99	29	38	47	55	64	73	81	90	99+
43 to 77	43	47	52	56	60	64	69	73	77+
49 to 116	49	57	66	74	83	91	99	108	116+
66 to 99	66	70	74	78	83	87	91	95	99+

INSTALLATION

CAUTION

1. The installer must be a trained, experienced serviceman.
2. Turn off gas supply before starting the installation.
3. Do not remove seal over control inlet or outlet until ready to make installation.
4. Carefully uncoil capillary tubing to prevent kinking or sharp bends.
5. Conduct a thorough checkout before leaving installation.

PREPARE PIPE AND INSTALL VALVE

1. Use new, properly reamed pipe free from chips.
2. Do not thread pipe too far. Valve distortion or malfunction may result from excess pipe in control.

LENGTH OF STANDARD PIPE THREADS (inches)

PIPE SIZE	EFFECTIVE LENGTH OF THREAD	OVERALL LENGTH OF THREAD
3/8	3/8	9/16
1/2	1/2	3/4
3/4	1/2 - 9/16	13/16
1	11/16	1

3. Apply moderate amount of good quality dope to pipe only, leaving 2 end threads bare. Use compound resistant to action of liquefied petroleum gases.

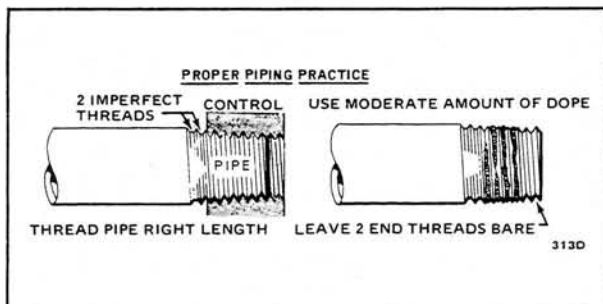

FIG. 2—PROPER PIPING PROCEDURE.

4. MAKE SURE THAT THE ARROW ON THE VALVE BODY IS POINTING IN THE DIRECTION OF THE GAS FLOW. Use a parallel jaw wrench or vise to screw the pipe onto the valve. Always place the parallel jaw wrench on the hex on the end of the valve body into which the pipe is being screwed. Never use the valve body as a handle, or cause the strain of tightening the valve to be carried through the valve body.

5. Install drip leg in gas supply pipe.

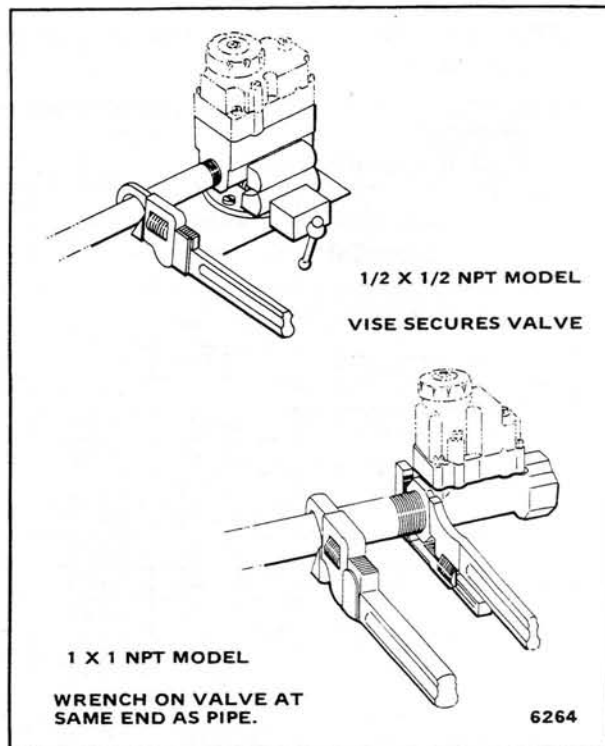

FIG. 3—SECURE VALVE WHEN CONNECTING PIPE.

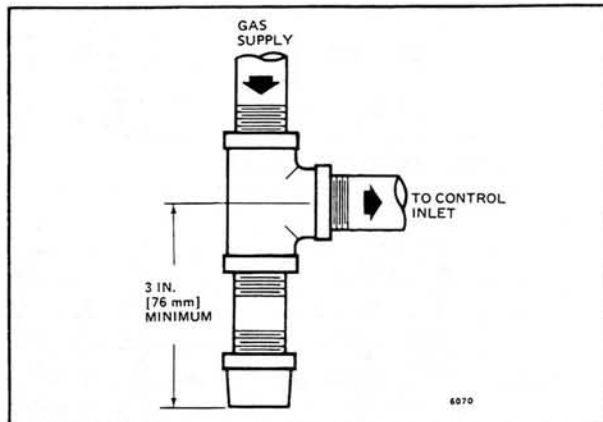

FIG. 4—TYPICAL DRIP LEG (SEDIMENT TRAP) INSTALLATION.

MOUNT BULB

Carefully uncoil capillary tubing to prevent kinking or sharp bends. Do not bend tubing within 1/2 inch [12.7 mm] of connection to bulb or operator. Repeated bending will "work harden" the tubing and may cause leaks or breakage.

HOT WATER BOILER INSTALLATION

The boiler manufacturer usually provides or recommends a suitable location for installation of the bulb. For satisfactory operation, it must be located in freely circulating water. See Accessories for separable wells and pressure fitting.

ROOM HEATER (WARM AIR) INSTALLATION

Fasten temperature-sensing bulb in return air-stream behind heater or beneath down-draft diverter. Do not run tubing through hot-air discharge or other extremely hot areas. Bulb must not be placed where it will be affected by radiant or conducted heat. Fix firmly in place with point-contact supports to reduce heat conduction. If necessary, shield bulb from radiant heat.

INSTALL PILOTSTAT, THERMOCOUPLE, PILOT BURNER AND PRESSURE REGULATOR VALVE (IF REQUIRED)

Follow installation instructions packed with each device, along with any instructions provided by furnace or burner manufacturer. Fig. 5 shows a typical installation.

CAUTION

On V5155B installations, an ON-OFF valve must be installed for main burner on-off operation.

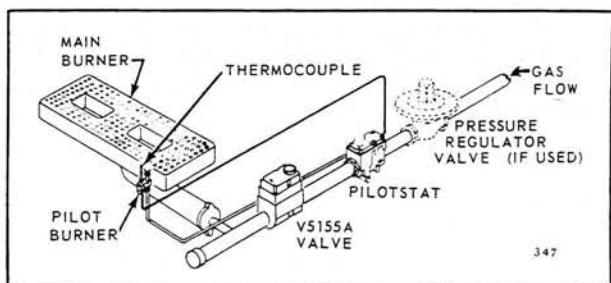

FIG. 5—TYPICAL INSTALLATION OF V5155A MODUSNAP VALVE.

CHECKOUT

SETTING TEMPERATURE DIAL

To increase temperature, turn dial toward 9. To decrease, turn dial toward 1. Refer to table under SPECIFICATIONS for equivalent temperature values. NOTE: Burner should operate for at least 2 hours when determining best setting.

TEST FOR GAS LEAKS

WARNING

DO NOT OMIT THIS TEST

With main burner in operation, paint pipe joints, pilot gas tubing connections, and valve gasket lines with rich soap and water solution. Bubbles indicate a gas leak. To stop leak, tighten joints and screws or replace the gasket.

MINIMUM FLAME CHECK

The pilot must be burning and the gas cock turned to ON. To make certain ignition and flame retention are satisfactory, proceed as follows.

V5155A MODUSNAP VALVE

1. The check must be made when temperature at bulb is within range of the control. If temperature is too low, set dial at 9, and allow burner to operate until temperature at sensing bulb is within the control range. Then change setting back to 1 (burner goes out) and proceed.

2. Turn dial slowly up the scale toward 9 until the instant the valve snaps open to minimum flame. *Main burner flame must not flash back to orifice and all burner ports must light.* Adjust minimum flame, if necessary, and recheck.

3. Turn off main burner by setting dial back to 1, and allow appliance to cool (but not cool enough to

cause burner to light at setting of 1). Turn burner on to minimum flame only, and again check for proper ignition and operation. Repeat several times.

V5155B MODULATING VALVE

1. The check must be made when temperature at bulb is within the range of the control. If temperature is too low, set dial at 9 and allow burner to operate until temperature at bulb is within the control range.

2. Turn dial to 1 to reach minimum flame condition.

3. Turn the separate ON-OFF control valve off, then on again after flame has extinguished. At the minimum flame condition, *main burner flame must not flash back to orifice and all burner ports must light.*

4. Turn off burner and allow appliance to cool. With dial still at 1, again check burner ignition as in step 3. Repeat several times.

RECALIBRATION

Deviation from the normal setting of the temperature control dial usually is caused by improper location or mounting of the temperature sensing bulb. Therefore, before recalibrating the control, review the precautions outlined under MOUNT BULB and make any necessary corrections.

If recalibration is necessary, proceed as follows:

1. Choose a time when the temperature at the bulb has been quite constant for half an hour as measured by a reliable thermometer, and the burner is operating.

2. Remove the temperature dial and screw.

3. Turn the calibration screw just until the burner snaps off or until burner reverts to minimum flame condition.

4. Replace the temperature dial and screw so that the dial number corresponding to the room temperature is aligned with the indicator on the valve body.

5. Recheck after the system is back in operation to see that it is maintaining the desired temperature.

OPERATION

Fig. 6 is an internal view of the V5155A Modusnap valve. The snap-acting valve is omitted in the V5155B modulating valve. In the position shown, the V5155A would be fully closed and the V5155B in the minimum flame condition.

The temperature sensing bulb, capillary tubing and bellows is filled with a temperature-sensitive liquid. Changes in temperature at the bulb contract the liquid on temperature fall and expand it on temperature rise, causing the bellows to shorten and lengthen, respectively. This movement is transmitted to the valve assembly by the horizontal pivot arm as shown.

The V5155A snaps open to a minimum flame condition, and modulates between minimum and maximum flame in proportion to the demand for heat. As the temperature approaches the set point of the temperature control knob, the flame diminishes and the valve snaps off.

The V5155B modulates in a similar fashion but does not fully shut off; an internal bypass governs the input at the minimum flame condition. A second valve, installed upstream in the manifold, is used for burner ON-OFF operation.

The V5155 with temperature range of 60 to 100 F [16 to 38 C] is for use on room heating appliances. The modulating flame feature of this control provides closer control of room temperature, continuously varying the input to match the heating load. Expansion noises of the heat exchanger are minimized at reduced flame and there are fewer on-off cycles.

Models with higher temperature ranges are for use on hot water boilers. Flame modulation tends to reduce short cycling on fast recovery boilers and maintains more constant water temperature.

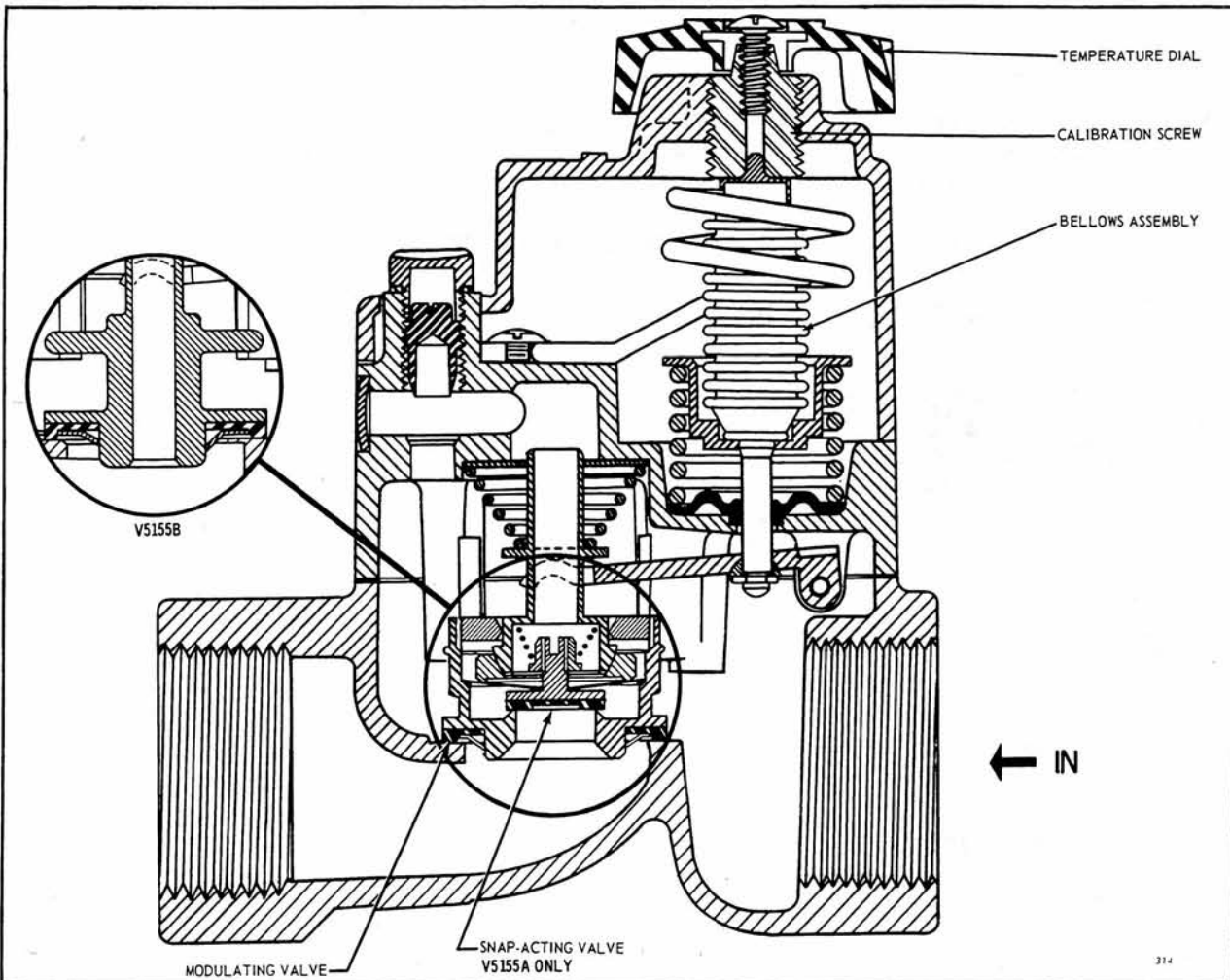

FIG. 6—INTERIOR VIEW OF V5155A (V5155B IN INSET).

Free Manuals Download Website

<http://myh66.com>

<http://usermanuals.us>

<http://www.somanuals.com>

<http://www.4manuals.cc>

<http://www.manual-lib.com>

<http://www.404manual.com>

<http://www.luxmanual.com>

<http://aubethermostatmanual.com>

Golf course search by state

<http://golfingnear.com>

Email search by domain

<http://emailbydomain.com>

Auto manuals search

<http://auto.somanuals.com>

TV manuals search

<http://tv.somanuals.com>