

UltraKey Plus

Keyboard Controller for VideoBloX and MAXPRO-Net Matrix Systems

Model: HJK7000

Installation and User Guide

Installation and User Guide

Revisions

Issue	Date	Revisions
A	03/2009	New document.
B	11/2009	Updates throughout

Explanation of Symbols



WARNING! The exclamation point in a red octagon is a WARNING. Failure to take or avoid a specific action could result in **physical harm to a person or irreparable damage to equipment.**



Caution The lightning flash with arrowhead symbol within an equilateral triangle alerts the user to the presence of uninsulated dangerous voltage within the enclosure of the product that **may be of sufficient magnitude to constitute a risk of electric shock to the person**



Caution The exclamation point in a yellow equilateral triangle is a Caution. Failure to take or avoid a specified action could result in **loss of data or damage to equipment** and may contain important operating and maintenance servicing information.

FCC Compliance Statement

Information to the User: This equipment has been tested and found to comply with the limits for a Class B digital device. Pursuant to Part 15 of the FCC Rules, these limits are designed to provide reasonable protection against harmful interference in a residential installation. This equipment generates, uses, and can radiate radio frequency energy and, if not installed and used in accordance with the instruction manual, may cause harmful interference to radio communications. However, there is no guarantee that interference will not occur in a particular installation.

If this equipment does cause harmful interference to radio or television reception, which can be determined by turning the equipment off and on, the user is encouraged to try to correct the interference. For example, try orienting or relocating the receiving antenna, increasing the separation between the equipment and receiver, or connecting the equipment to an outlet on a different circuit.

This device complies with part 15 of the FCC rules. Operation is subject to the following two conditions: (1) This device may not cause harmful interference, and (2) this device must accept any interference received, including interference that may cause undesired operation.



Changes or modifications not expressly approved by the party responsible for compliance could void the user's authority to operate the equipment.

Users of the product are responsible for checking and complying with all federal, state and local laws and statutes concerning the monitoring and recording of video and audio signals. Honeywell Systems Group shall not be held responsible for the use of this product in violation of current laws and statutes.

Canadian Compliance Statement

This Class B digital apparatus complies with Canadian ICES-003.
Cet appareil numérique de la classe B est conforme à la norme NMB-003 du Canada.

European Compliance Statement

This is a Class B product. In a domestic environment this product may cause radio interference in which case the user may be required to take adequate measures.

CAUTION: Users of the product are responsible for checking and complying with all federal, state, and local laws and statutes concerning the monitoring and recording of video and audio signals. Honeywell video systems shall not be held responsible for the use of this product in violation of current laws and statutes.

Manufacturer's Declaration of Conformance (ACUIX)

North America

The equipment supplied with this guide conforms to UL60065, CAN/CSA C22.2 No. 60065:03.

Europe

The manufacturer declares that the equipment supplied with this guide is compliant with the essential protection requirements of the EMC directive 2004/108/EC and the Low Voltage Directive LVD 2006/95/EC, conforming to the requirements of standards EN 55022 for emissions, EN 50130-4 for immunity, and EN 60065 for Electrical Equipment safety.

Warnings and Cautions

Read the following cautions and warnings prior to installation and use of this product.



Installation and servicing must be performed by qualified personnel in accordance with local codes and regulations.



Consider using a UPS source to ensure satisfactory performance.

Using replacement parts or accessories other than the original manufacturers may invalidate the warranty.



Important Safety Instructions

BEFORE OPERATING OR INSTALLING THE UNIT, READ AND FOLLOW ALL INSTRUCTIONS. AFTER INSTALLATION, retain the safety and operating instructions for future reference

1. **HEED WARNINGS** - Adhere to all warnings on the unit and in the operating instructions.
2. **INSTALLATION**
 - Install in accordance with the manufacturer's instructions.
 - Installation and servicing should be performed only by qualified and experienced technicians to conform to all local codes and to maintain your warranty.
 - Do not install the unit in an extremely hot or humid location, or in a place subject to dust or mechanical vibration. The unit is not designed to be waterproof. Exposure to rain or water may damage the unit.
3. **POWER SOURCES** - This product should be operated only from the type of power source indicated on the marking label. If you are not sure of the type of power supplied to your facility, consult your product dealer or local power company.

4. **HEAT** - Situate away from items that produce heat or are heat sources such as radiators, heat registers, stoves, or other products (including amplifiers).
5. **WATER AND MOISTURE** - Do not use this unit near water or in an unprotected outdoor installation, or any area classified as a wet location.
6. **ATTACHMENTS** - Do not use attachments not recommended by the product manufacturer as they may result in the risk of fire, electric shock, or injury to persons.
7. **ACCESSORIES** - Only use accessories specified by the manufacturer.
8. **CLEANING** - Do not use liquid cleaners or aerosol cleaners. Use a damp cloth for cleaning.
9. **SERVICING** - Do not attempt to service this unit yourself as opening or removing covers may expose you to dangerous voltage or other hazards. Refer all servicing to qualified service personnel.
10. **REPLACEMENT PARTS** - When replacement parts are required, be sure the service technician has used replacement parts specified by the manufacturer or have the same characteristics as the original part. Unauthorized substitutions may result in fire, electric shock or other hazards.

Warranty and Service

Subject to the terms and conditions listed on the Product Warranty Card, during the warranty period Honeywell will repair or replace, at its sole option, free of charge, any defective products returned prepaid.

In the event you have a problem with any Honeywell product, call Customer Service for assistance or to request a **Return Merchandise Authorization (RMA)** number. Be sure to have the model number, serial number, and the nature of the problem available for the technical service representative.

In the U.S.A. and Canada, call 1.800.796.2288. See the back cover for other contact details.

Prior authorization must be obtained for all returns, exchanges, or credits. **Items shipped to Honeywell without a clearly identified Return Merchandise Authorization (RMA) number may be refused.**

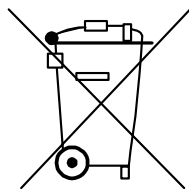

WEEE (Waste Electrical and Electronic Equipment). Correct disposal of this product (applicable in the European Union and other European countries with separate collection systems). This product should be disposed of, at the end of its useful life, as per applicable local laws, regulations, and procedures

Contents

	About this Document and the UltraKey Plus	15
	Document Overview	15
	Finding More Information.	16
	Typographical Conventions	16
	UltraKey Plus Specifications	17
	Shipping Checklist	18
	UltraKey Plus Port Connections and Descriptions.	19
	DC Power Port	19
	Ethernet Port	20
	RS232, RS422/485 Serial Port	20
	USB Port	20
1	Using the UltraKey Plus Controller.	21
	Logging Onto the Controller	21
	Using the UltraKey Plus to Navigate the LCD Menus	22
	VideoBloX Key Functions.	24
	MAXPRO Key Functions	26
2	Installing UltraKey Plus with VideoBloX	29
	Navigating the LCD Configuration Menus	30
	Installing and Configuring a Serial Connection	31
	Step 1: Connect to the UltraKey Plus Using the Serial Port	31
	Step 2: Configure Port Settings	33
	Step 3: Configure Address	34
	Step 4: Configure the Controller for VideoBloX Mode	34
	Installing and Configuring an Ethernet Connection	35
	Step 1: Connect to the UltraKey Plus Ethernet Port	35
	Step 2: Set and Configure for an Ethernet Connection	36
	Step 3: Configure Address	37
	Step 4: Configure the Controller for VideoBloX Mode	37
	(Optional) Configuring UltraKey Plus Using the Web Browser	37
	Logging onto the Web Browser	37
	Step 1: Configure UltraKey Plus to VideoBloX Mode	38
	Step 2: Configure VideoBloX Network Settings	39
	Step 3A: Configure the Controller for a Serial Port Connection	39
	Step 3B: Configure the Controller for an Ethernet Connection	40
3	Installing UltraKey Plus with MAXPRO-Net	41
	Navigating the LCD Configuration Menus	42
	Installing and Configuring a Serial Connection	43
	Step 1: Connect to the UltraKey Plus Using the Serial Port	43
	Step 2: Configure Port Settings	46
	Step 3: Configure Address and Joystick Speed	47

Step 4: Configure the Controller for MAXPRO Mode.	47
Installing and Configuring an Ethernet Connection	48
Step 1: Connect to the UltraKey Plus Ethernet Port	48
Step 2: Set and Configure for an Ethernet Connection	48
Step 3: Configure Address and Joystick Speed	49
Step 4: Configure the Controller for MAXPRO Mode.	49
(Optional) Configuring UltraKey Plus Using the Web Browser	50
Logging onto the Web Browser	50
Step 1: Configure UltraKey Plus to MAXPRO Mode	50
Step 2: Configure MAXPRO Network Settings	51
Step 3A: Configure the Controller for a Serial Port Connection	52
Step 3B: Configure the Controller for an Ethernet Connection	53
4 System Administration and Troubleshooting	55
System Administration Using the Controller LCD	55
Logging on and Navigating to the Settings Menu	55
Configuring the Hardware	56
Managing the Users	58
Configuring Hardkeys	59
Checking the Hardware.	62
User Menus	62
Selecting the Language	63
Loading Defaults	63
General Information.	64
VB Communication Mode	64
System Mode	64
System Administration Using the Web Browser	64
Logging onto the Web Browser	64
Configuring the Hardware	65
Managing the Users	65
Configuring Hardkeys	66
Configuring File	67
Upgrading the UltraKey Plus Firmware.	68
Rebooting UltraKey Plus	68
Changing the UltraKey Plus Password	69
Index	71

Figures

Figure 0-1	UltraKey Plus Port Connections	19
Figure 1-1	UltraKey Plus Controller Keyboard Layout	22
Figure 1-2	The UltraKey Navigation Controls	23
Figure 2-1	LCD and LCD Navigation Keys	30
Figure 2-2	AC Power Adapter with CEE 7/16 Europlug	32
Figure 2-3	RJ45 to DB9 Male Adapter for VideoBloX and VideoBloX Lite CPUs	32
Figure 2-4	Direct RJ45 Serial Port Connection for VideoBloX NetCPUs	32
Figure 2-5	VideoBloX Serial Port RS422 Connection Example	33
Figure 2-6	Ethernet Port Connections to VideoBloX	36
Figure 2-7	UltraKey Plus Login Page	38
Figure 2-8	System Configuration Tab	38
Figure 2-9	VideoBloX Configuration Tab	39
Figure 2-10	Port Settings Tab	40
Figure 2-11	IP Configuration Tab	40
Figure 3-1	LCD and LCD Navigation Keys	42
Figure 3-2	RS232 Serial Port Connections	44
Figure 3-3	RS232 Serial Port Connection and MegaPIT	44
Figure 3-4	RS232 Serial Port Connection and MX18	45
Figure 3-5	AC Power Adapter with CEE 7/16 Europlug	45
Figure 3-6	RJ45 to DB9 Female Adapter (RS232)	46
Figure 3-7	RS422 to RS232 Converter Using the Terminal Box (RS422)	46
Figure 3-8	Ethernet Port Connections to MAXPRO-Net	48
Figure 3-9	UltraKey Plus Login Page	50
Figure 3-10	System Configuration Tab	51
Figure 3-11	MAXPRO Configuration Tab	52
Figure 3-12	Port Settings Tab	53
Figure 3-13	IP Configuration Tab	53
Figure 4-1	Configure Hardware	65
Figure 4-2	Manage Users	66
Figure 4-3	Configuring Hardkey	67
Figure 4-4	Configuring File	67
Figure 4-5	Software Upgrade Warning Message	68
Figure 4-6	System Reboot	69
Figure 4-7	Change Password Page	69

Tables

Table 0-1	UltraKey Plus Specifications	17
Table 0-2	Shipping Checklist	18
Table 1-1	VideoBloX Key Functions.	24
Table 1-2	MAXPRO Key Functions	26
Table 2-1	Serial Port COM1 and COM2 Pin Assignments	31
Table 2-2	RJ45 Ethernet Pin Assignments	35
Table 3-1	Serial Port COM1 and COM2 Pin Assignments	43
Table 3-2	RJ45 Ethernet Pin Assignments	48

About this Document and the UltraKey Plus

In this section:

- [Document Overview, page 15](#)
- [Finding More Information, page 16](#)
- [Typographical Conventions, page 16](#)
- [UltraKey Plus Specifications, page 17](#)
- [Shipping Checklist, page 18](#)
- [UltraKey Plus Port Connections and Descriptions, page 19](#)

The UltraKey Plus (HJK7000) is a replacement for the Honeywell Ultrakey (HEGSA002) controller and is compatible with Honeywell VideoBloX and MAXPRO-Net Video Matrix Systems.

The UltraKey Plus has these modes available, depending on the installation:

- MAXPRO: For use with MAXPRO-Net Matrix System installations.
- VideoBloX: For use with VideoBloX Matrix System installations.

Document Overview

This user guide includes:

- UltraKey Plus controller user instructions ([Chapter 1](#)).
- Installation/connection and configuration instructions specific to VideoBloX ([Chapter 2](#)).
- Installation/connection and configuration instructions specific to MAXPRO-Net ([Chapter 3](#)).
- System Administration and troubleshooting ([Chapter 4](#))

Finding More Information

Refer to the online literature library to access other electronic documents in PDF format including data sheets, quick references, installation and user guides, specifications, software and product notices: <http://www.honeywellvideo.com>. Also see the back cover for international web sites and contact details.

Typographical Conventions

This document uses these typographical conventions:

Font	What it represents	Example
Helvetica bold	Keys on the controller keyboard.	Press Ent
Swiss721 BT Bold	Words or characters that are part of the task process and identify a field and an action that must be typed.	Enter the password 1234 .
	Menu titles and other items you select.	Double-click Open from the File menu.
	Buttons you click on a web browser to perform actions.	Click Exit to close the program.
	Pressing a key on the keyboard.	Press and hold Login .
Lucida	Text that displays on the LCD screen	The LCD menu <code>IPAddr</code> Changed displays.
<i>Italic</i>	Placeholders: words that vary depending on the situation.	<i>user name</i>
	Cross-reference to external source.	Refer to the <i>System Administrator Guide</i> .
	Cross-reference within document.	See <i>Chapter 2, Installation</i> .

UltraKey Plus Specifications



Table 0-1 UltraKey Plus Specifications

Parameter	Value
Power Requirements	10.8 to 13.2 VDC @ 1 Ampere (A) or POE (48VDC, Class 3)
Connector Types	1×Ethernet (10Base-T, 100Base-TX) RJ45 With LED 1×RS232/422/485 RJ45 With LED
LCD	Type: TFT Backlight: LED Characters: 320×240 Dots
USB	Type: A Version: USB1.1 (For USB PC Keyboard)
Compliance	EN55022 for radiated and conducted emissions
Mechanical	Dimensions: 17.22 in (437 mm) (L) × 8.76 in (222 mm) (W) × 3.31 in (109 mm) (H) Gross Weight: 7 pounds (3.2 kg) Cover material: ABS+PC (cool gray)
Environment	Operating Temperature: 14 to 131 deg F (-10 to +55 deg C) Storage Temperature: -40 to 167 deg F (-40 to +75 deg C) Humidity: 0 to 95% RH (non-condensing)

Shipping Checklist

The following is included with your UltraKey Plus Controller shipment. Use of accessories is dependent on the type of installation. Ultrakey Plus can be connected to the matrix system either by serial port or Ethernet RJ45 connections.

Table 0-2 Shipping Checklist

Quantity	Part	Use with...
1	Ultrakey Plus keyboard controller	All installations.
1	Ultrakey Plus installation and user guide	All installations.
1 box	Power adapter with plugs for 100-240 VAC, 12 VDC, 50-60 Hz, 1 A, 12 W	<p>Plug adapters depend on local electrical current. Four models are included:</p> <ul style="list-style-type: none"> • CEE 7/16 (Europlug 2.5 A/250V unearthed) • NEMA 1-15 (North American 15 A/125V ungrounded) • BS1363 (British 13 A/230-240V 50 Hz earthed and fused) • CPCS-CCC (Chinese 10 A/250V)/AS 3112; Australian 10 A/240V).
		
1	Connector adapter, RJ45 to DB9 male, for RS422	 <p>Backwards compatibility with VideoBloX and VideoBloX Lite CPU installations. VideoBloX master port.</p>
1	Connector adapter, RJ45 to DB9 female, for RS232	 <p>Backwards compatibility with MAXPRO-Net CPU installations.</p>
1	RJ45 network cable, 2 meters	All installations.
1	RJ11 4X6 flat ribbon cable, 2 meters	To connect from a MAXPRO and MX18 to the UltraKey Plus.

UltraKey Plus Port Connections and Descriptions

Figure 0-1 UltraKey Plus Port Connections

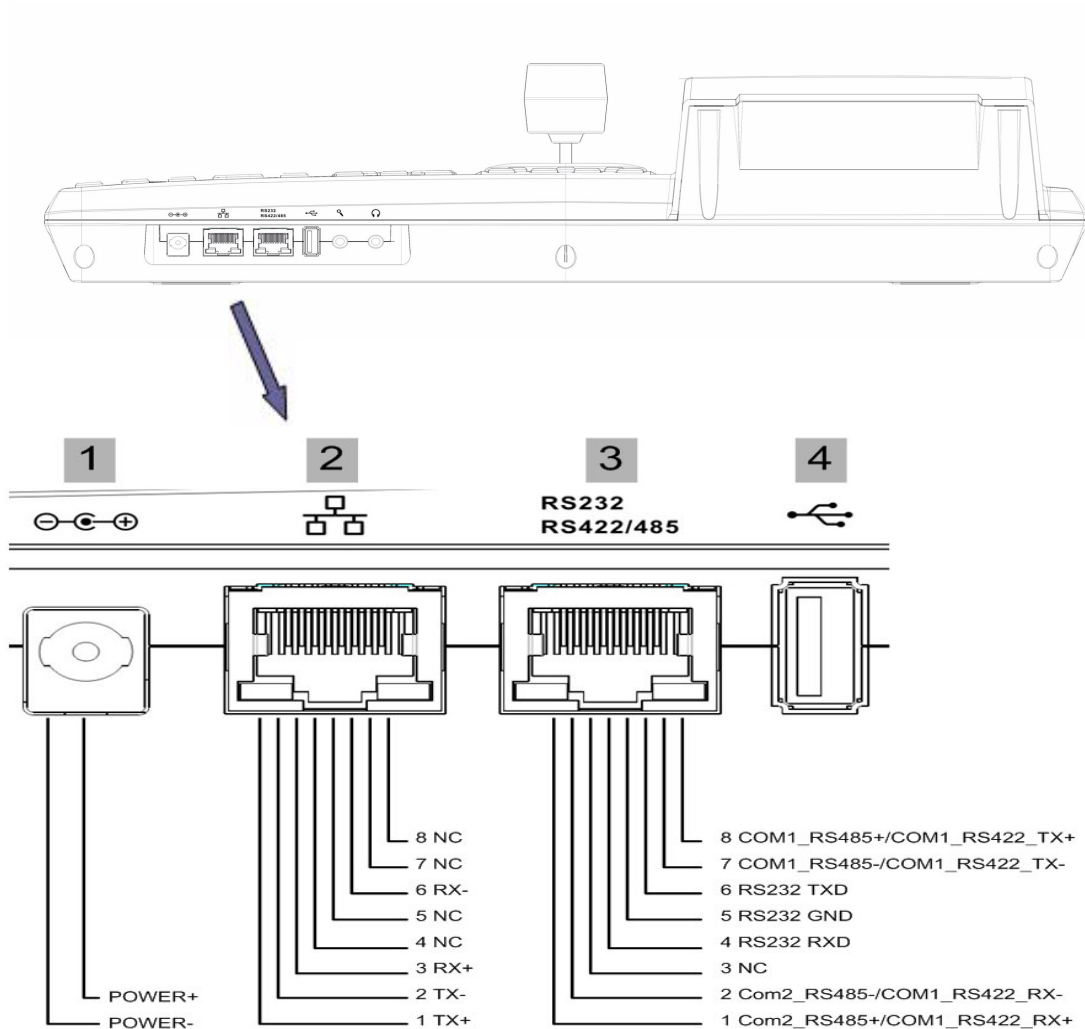

DC Power Port

Supports 12V ($\pm 10\%$) DC/1 A power input. Use the power adapter included with the shipment and insert one of the four adapters, based on your local power requirements.

Ethernet Port

Note Ethernet is used to connect to the controller web browser, MAXPRO-Net or VideoBloX NetCPU.

- 10/100M Ethernet PoE (power over Ethernet) input. If PoE is the power input, it is not recommended to connect this network with an outside building.
- TCP/IP protocol on the controller.
- For VideoBloX, the controller address range can be between 1 and 32. For MAXPRO-Net, the address range can be between 1 and 99.

RS232, RS422/485 Serial Port

Note These ports are used to connect to MAXPRO-Net RS232 or RS422 and to VideoBloX NetCPU, Standard CPU and Lite CPU RS422.

An isolated surge protection is suggested when using RS485/RS422 and when cabling between buildings.

Note For MAXPRO-Net installations, COM1 (RS422) and COM2 (RS485) are configured using the controller LCD menu and cannot be used at the same time.

USB Port

Note The USB port is not used with VideoBloX or MAXPRO-Net.

The USB port is used for connecting to a QWERTY USB keyboard. The following USB keyboards are recommended:

- **Logitech** Y-UB83(Logitech Classic New Touch Keyboard 200USB)
- **Logitech** Y-BP62a
- **Dell** L110

Using the UltraKey Plus Controller

You may need to learn how to use the UltraKey Plus both before and after you begin configuring. Key availability is dependent on the mode selected. In this section:

- [Logging Onto the Controller](#), page 21
- [Using the UltraKey Plus to Navigate the LCD Menus](#), page 22
- [VideoBloX Key Functions](#), page 24
- [MAXPRO Key Functions](#), page 26

Logging Onto the Controller

1. Connect the keyboard with a power adapter (12V ($\pm 10\%$) DC/1 A included) or a network cable with POE. The system will enter VB mode or MAXPRO mode.
2. Press **Alt** + **Clr** + **Home** keys on the controller.
The login screen displays.
3. Enter the PIN password **3434**.
The Settings screen displays.

Note If an invalid password is entered, a warning message displays. Repeat the steps to log on.

Using the UltraKey Plus to Navigate the LCD Menus

There are a variety of ways to navigate both the LCD menu during configuration and set up as well as during normal operation with your matrix system. *Figure 1-1* shows the layout of the UltraKey Plus and *Table 1-1* describes the key functions. See *Figure 1-2* for a brief overview of the three main navigation options.

Figure 1-1 UltraKey Plus Controller Keyboard Layout

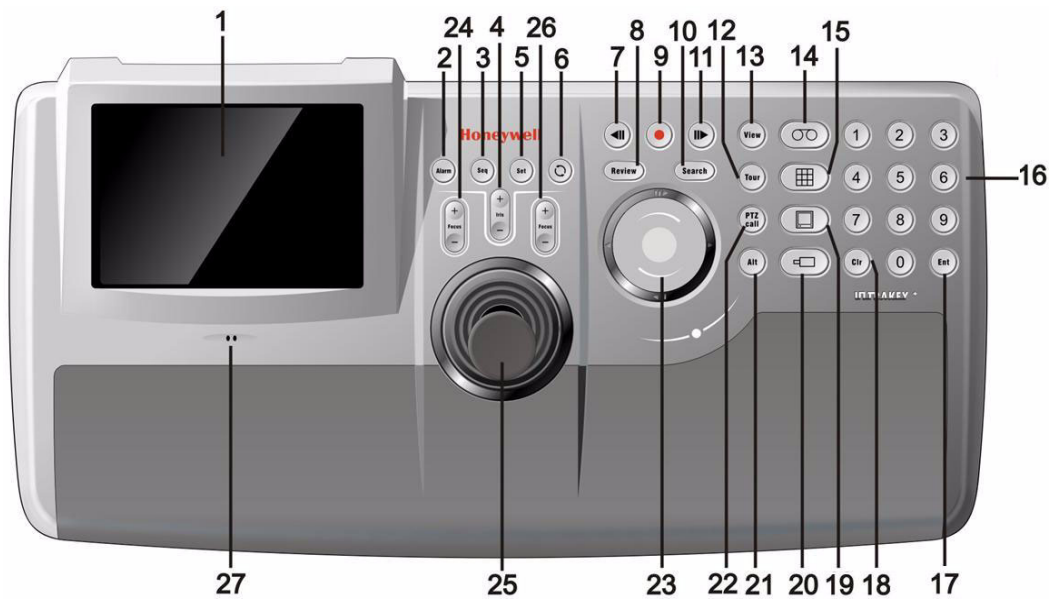
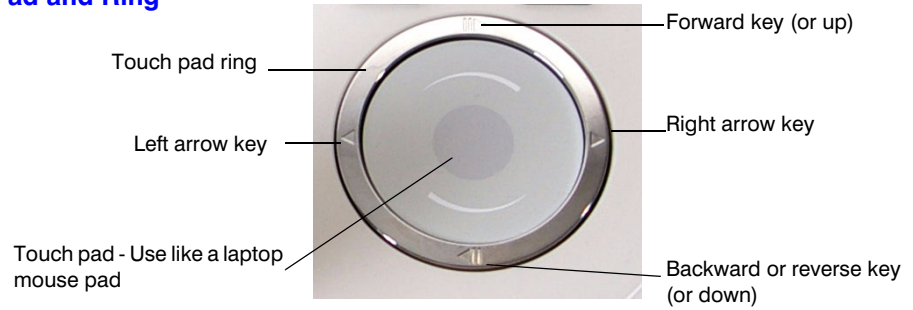
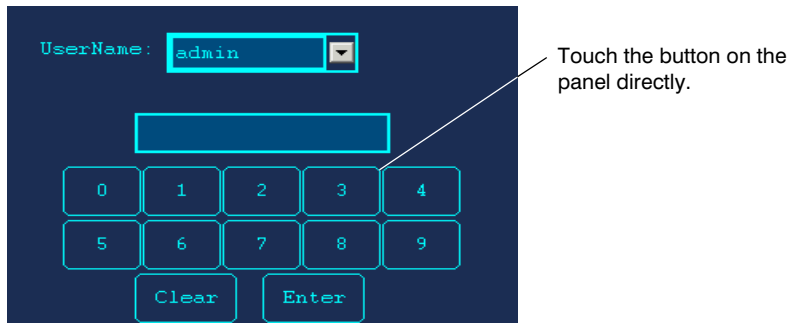

Figure 1-2 The UltraKey Navigation Controls

Touch Pad and Ring



Touch Panel



Joystick

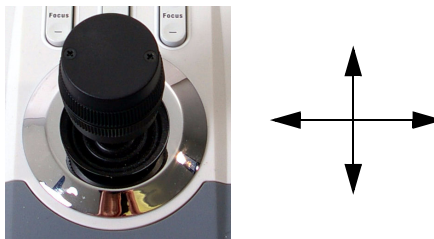

VideoBloX Key Functions

Note Use *Figure 1-1* to locate each key as labeled in the ID column below.

Table 1-1 VideoBloX Key Functions

ID	Key Description	Function in Camera Mode	PCK (Cam Mode)	PCK (Device Mode)
2	Alarm	Acknowledge Alarms	Alarm Ack	Alarm Ack
3	Seq	Selects Sequence mode	SEQ	SEQ
4	Iris -	Iris Close -	Iris Close	Frame <
4	Iris +	Iris Open +	Iris Open	Frame >
5	Set	Store a preset (preshot)	Store	Stop
6	Recycle (Undo)	Undo previous camera selection (NetCPU)	<-	VCR F2
7	Pause Play Rev	Selects previous camera	Prev	Stop
8	Review	Puts keyboard in Device mode	NA	Pause
9	Record	Store a preset (preshot)	Store	Rec
10	Search	Puts keyboard in Device mode	NA	Index -
11	Pause Play Fwd	Selects next camera	Next	Play
12	Tour	Tour 1 Runs SEQ 250 on CPU Tour 2 Runs SEQ 251 on CPU Tour 3 Runs SEQ 252 on CPU Tour 4 Runs SEQ 253 on CPU	NA	
13	View	Recall a preset (preshot)	Recall	Play
14	VCR	Selects Device mode	VCR	VCR
15	MUX Screen	MUX 1 Runs SEQ 245 on CPU MUX 2 Runs SEQ 246 on CPU MUX 3 Runs SEQ 247 on CPU MUX 4 Runs SEQ 248 on CPU	NA	Index +
16	Numeric Keys 0-9	Numeric Entry	Numeric Keys 0-9	Numeric Keys 0-9
17	Enter	Accept entry	Enter	Enter
18	Clear	Clear previous entry	Clr	Clr
19	Monitor	Selects Monitor mode	MON	MON
20	Camera	Selects Camera mode	CAM	CAM
22	PTZ Call	Selects Alternate camera (NetCPU)	Enter	

Table 1-1 VideoBloX Key Functions

ID	Key Description	Function in Camera Mode	PCK (Cam Mode)	PCK (Device Mode)
23	Touch wheel right	Selects next camera	Next	Next
23	Touch wheel left	Selects previous camera	Prev	Prev
23	Touch ring Up	Nudges PTZ Up	Up	Up
23	Touch ring Down	Nudges PTZ Down	Down	Down
23	Touch ring Left	Nudges PTZ Left	Left	Left
23	Touch ring Right	Nudges PTZ Right	Right	Right
25	Joystick Left	Move PTZ left variable speed	Joystick Left	Joystick Left
25	Joystick Right	Move PTZ right variable speed	Joystick Right	Joystick Right
25	Joystick Up	Move PTZ up variable speed	Joystick Up	Joystick Up
25	Joystick Down	Move PTZ down variable speed	Joystick Down	Joystick Down
25	Twist Zoom right	Zoom PTZ in variable speed	Twist Zoom right	Twist Zoom right
25	Twist Zoom left	Zoom PTZ out variable speed	Twist Zoom left	Twist Zoom left
24/26	Focus Near +	Focus Near +	Focus N	Rew
24/26	Focus Far -	Focus Far -	Focus F	Fwd

MAXPRO Key Functions

Note Use *Figure 1-1* to locate each key as labeled in the ID column below.

Table 1-2 MAXPRO Key Functions

ID	Key Description	Key Code	Default MAX Function	UltraKey
2	Alarm	1	Full Screen	Alarm Ack
3	Seq	3	None	None
4	Iris +	90	Iris Open	Iris +
4	Iris -	91	Iris Close	Iris -
5	Set	15	None	Set
6	Recycle (Undo)	49	None	
7	Pause Play Rev	80	VCR Rewind	VCR Rewind
8	Review	85	Text	Review
9	Record	77	Stop	Stop
10	Search	79	VCR Record	Record
11	Pause Play Fwd	78	Play	Play
12	Tour	95	Flashback	Tour 1
13	View	74	View	View
14	VCR	47	F4	None (Menu)
15	MUX Screen	43	None	Mux
16-1	Number 1	62	Keypad key 1	Keypad key 1
16-2	Number 2	63	Keypad key 2	Keypad key 2
16-3	Number 3	64	Keypad key 3	Keypad key 3
16-4	Number 4	66	Keypad key 4	Keypad key 4
16-5	Number 5	67	Keypad key 5	Keypad key 5
16-6	Number 6	68	Keypad key 6	Keypad key 6
16-7	Number 7	70	Keypad key 7	Keypad key 7
16-8	Number 8	71	Keypad key 8	Keypad key 8
16-9	Number 9	72	Keypad key 9	Keypad key 9
16-0	Number 0	75	Keypad key 0	Keypad key 0

Table 1-2 MAXPRO Key Functions

ID	Key Description	Key Code	Default MAX Function	UltraKey
17	Enter	76	Enter	Enter
18	Clear	808	Pause	808
19	Monitor	61	Monitor	Monitor
20	Camera	73	Camera	Camera
21	Alt	50	Mux	Alt
22	PTZ Call	94	PTZ Call	PTZ Call
23	Touch wheel right	105 (1-8)	None	None
23	Touch wheel left	104 (1-8)	None	None
23	Touch ring Up	65	up arrow	up arrow
23	Touch ring Down	69	down arrow	down arrow
23	Touch ring Left	23	none	Left Arrow
23	Touch ring Right	25	none	Right Arrow
25	Joystick Left			
25	Joystick Right			
25	Joystick Up			
25	Joystick Down			
25	Twist Zoom right			
25	Twist Zoom left			
24/26	Focus Near +	89	Focus Far	Focus -
24/26	Focus Far -	88	Focus Near	Focus +

Installing UltraKey Plus with VideoBloX

In this section:

- [Navigating the LCD Configuration Menus](#), page 30
- [Installing and Configuring a Serial Connection](#), page 31
- [Installing and Configuring an Ethernet Connection](#), page 35
- [\(Optional\) Configuring UltraKey Plus Using the Web Browser](#), page 37

Note For all installations, refer to the applicable VideoBloX or VideoBloX Lite installation or user guides that came with your unit for more information.

This section explains how to connect the UltraKey Plus controller to VideoBloX and how to enter the basic configuration settings specific to VideoBloX. UltraKey Plus can control the remote VideoBloX via either the serial port or the Ethernet.

Navigating the LCD Configuration Menu

Figure 2-1 LCD and LCD Navigation Keys

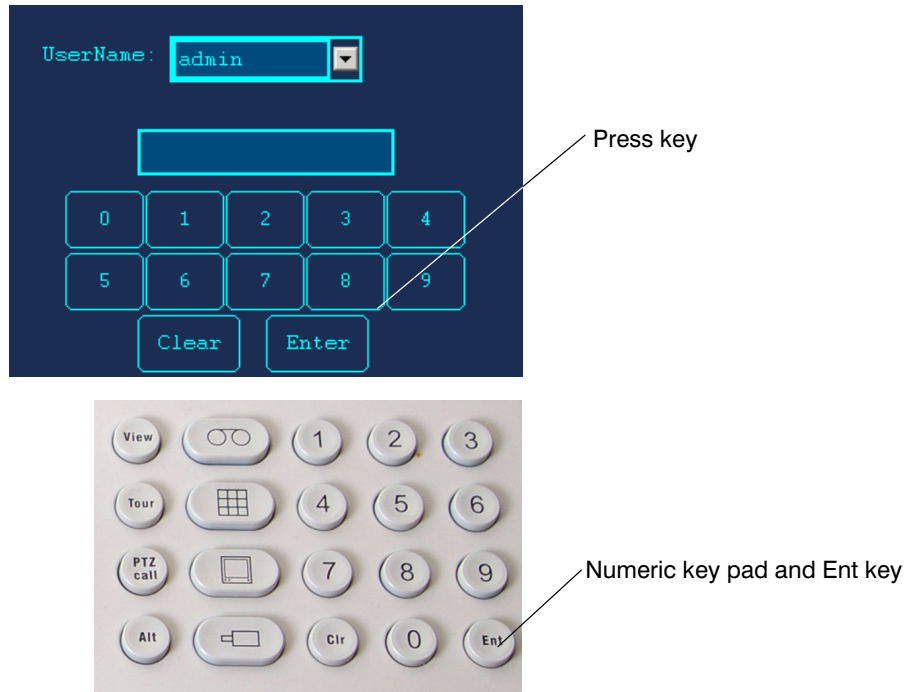

Installing and Configuring a Serial Connection

Step 1: Connect to the UltraKey Plus Using the Serial Port

Note Use only COM1 when in VideoBloX mode. See [Table 2-1](#) below.

Table 2-1 Serial Port COM1 and COM2 Pin Assignments

Serial Port	Type	Pin	Signal
COM1	RS422	1	RX +
		2	RX -
		5	GND
		7	TX -
		8	TX +
	RS485	7	T/R -
		8	T/R +

Note For a list of accessories see [Shipping Checklist](#) on page 18.

For port connections see [UltraKey Plus Port Connections and Descriptions](#) on page 19.

To connect to the UltraKey Plus using the serial port:

1. Select the applicable adapter plug and insert it into the AC adapter. Push to click it into place. See [Figure 2-2](#).
2. Plug the AC adapter into the controller power port and the adapter into a power source.
3. Connect an RJ45 network cable to the controller serial port.
4. Connect the RJ45 network cable to VideoBloX:
 - For backwards compatibility with VideoBloX and VideoBloX Lite CPUs, an RJ45 to DB9 male adapter is required and included with your shipment. See [Figure 2-3](#).
 - For VideoBloX NetCPU, the installation is a direct connection with the RJ45 network cable, also included. See [Figure 2-4](#) and [Figure 2-5](#).

Figure 2-2 AC Power Adapter with CEE 7/16 Europlug

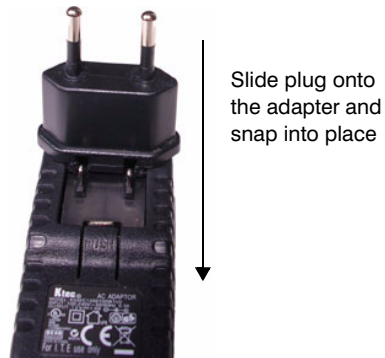

Figure 2-3 RJ45 to DB9 Male Adapter for VideoBloX and VideoBloX Lite CPUs

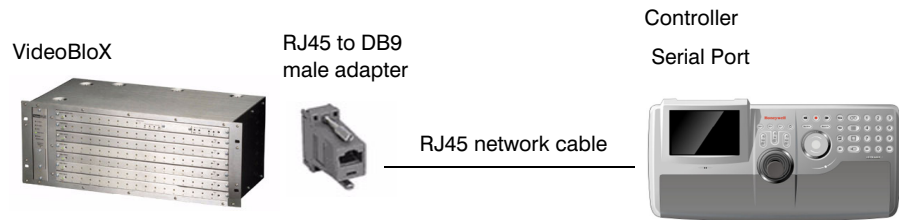

Figure 2-4 Direct RJ45 Serial Port Connection for VideoBloX NetCPUs

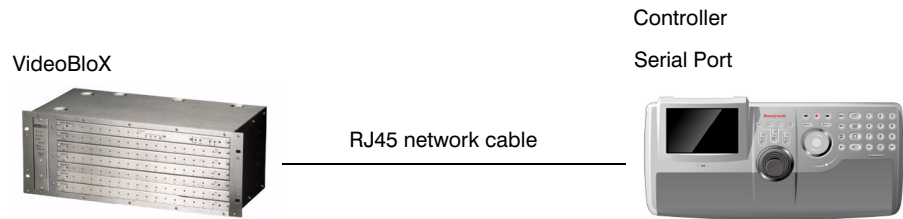
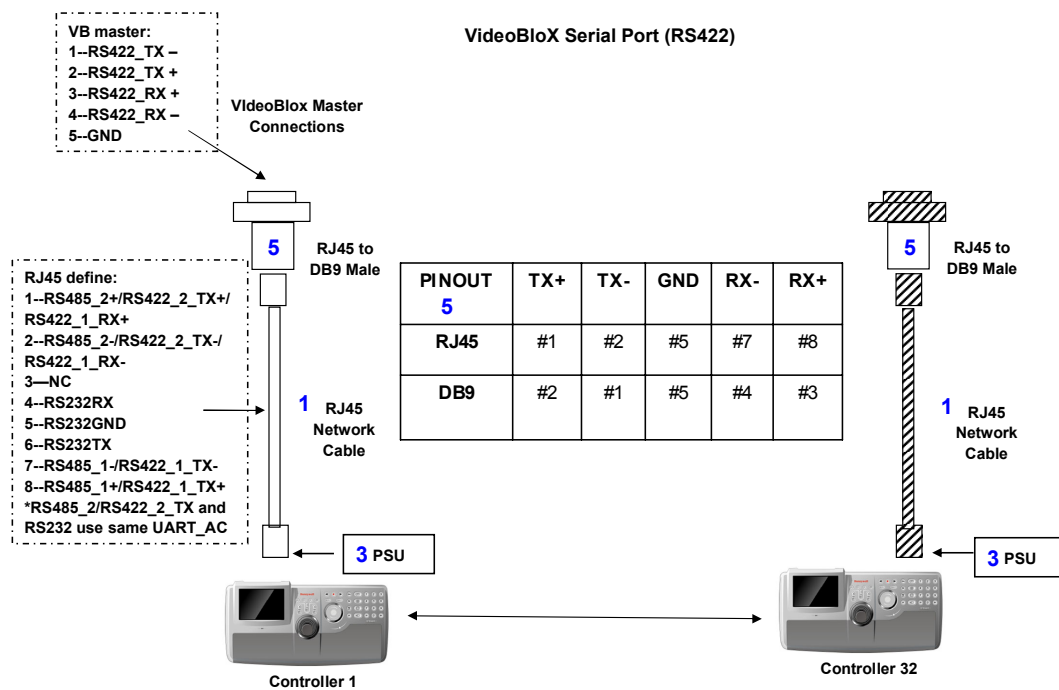

Figure 2-5 VideoBloX Serial Port RS422 Connection Example



Step 2: Configure Port Settings

To configure port settings:

1. Apply AC power to the controller after all the devices have been connected correctly.
2. Press **Alt + Clr + Home** keys on the controller to display the Login page.
3. Enter the PIN password **3434**.
The **Settings** screen displays.
4. If current mode is **MAXPRO** mode, change it to **VB** mode by pressing the **Mode Maxpro** button and logging into the Settings menu again.
5. Press **Hardware Config**.
The current controller setting is displayed.
6. Press **Port Settings** and then **COM1**.
The Serial Setting menu displays where you can see these COM1 settings - serial port mode, baud rate, databit, parity and stop bit.
7. Press **Type** to change the current type displayed on the screen. Select **RS422**.
8. Press **Baudrate** to select a baud rate: **1200 bps, 1800, 2400, 4800, 9600, 19200, or 57600**.

Note The default baud rate for VideoBloX is 19200 bps. It is recommended that you do not change this setting.

9. Press **DataBit** to select **7 bit** or **8 bit**.
10. Press **parity** to select **Even, Odd** or **None**.
11. Press **Stop Bit** to select **1 bit** or **2 bit**.
12. Press **Save**, and then **Quit**.
13. If you are using the TCP/IP to connect to a VideoBloX NetCPU, press **Ethernet**.

Note In this field, you are setting the VideoBloX Netcpu IP address. To set the UltraKey Plus IP address, see [Step 2: Set and Configure for an Ethernet Connection](#), page 36.

Step 3: Configure Address

To configure the controller address:

1. Press **Quit** to exit from **Port Settings** menu.
2. Press **Keyboard Addr** to select an address between 1 and 32 to assign to the controller. You can also use the numeric keypad to enter a number between 1 and 32. Entering a number greater than 32, makes this operation invalid.
3. Press **Enter** to save the address and exit the configuration menu.

Step 4: Configure the Controller for VideoBloX Mode

To configure the controller for VideoBloX mode:

1. Press **Users Menu** to display the configuration screen.
2. Refer to [User Menus](#) on page 62 to configure the device.
3. Press **Home** and then **Quit** to exit when the configuration is finished.

Installing and Configuring an Ethernet Connection

For a list of accessories see [Shipping Checklist](#) on page 18 and for port connections and pin assignments see [UltraKey Plus Port Connections and Descriptions](#) on page 19. The UltraKey Plus Controller runs TCP/IP keyboard protocol.

Step 1: Connect to the UltraKey Plus Ethernet Port

Note The direct RJ45 connection using the Ethernet port is only available with newer model VideoBloX NetCPU systems.

Table 2-2 RJ45 Ethernet Pin Assignments

Port	Pin	Signal
RJ45 Ethernet	1	TX +
	2	TX -
	3	RX+
	6	RX-

To connect to the UltraKey Plus Ethernet port:

1. Select the applicable adapter plug and insert it into the AC adapter. Push to click it into place. See [Figure 2-2](#).
2. Plug the AC adapter into the controller power port and the adapter into a power source.
3. Plug an RJ45 network cable from the network to the controller Ethernet port. Up to 32 controllers can be connected to the network. See [Figure 2-6](#).
4. Connect VideoBloX to the network. Refer to the applicable [VideoBloX Installation Guide](#) for instructions.

Figure 2-6 Ethernet Port Connections to VideoBloX

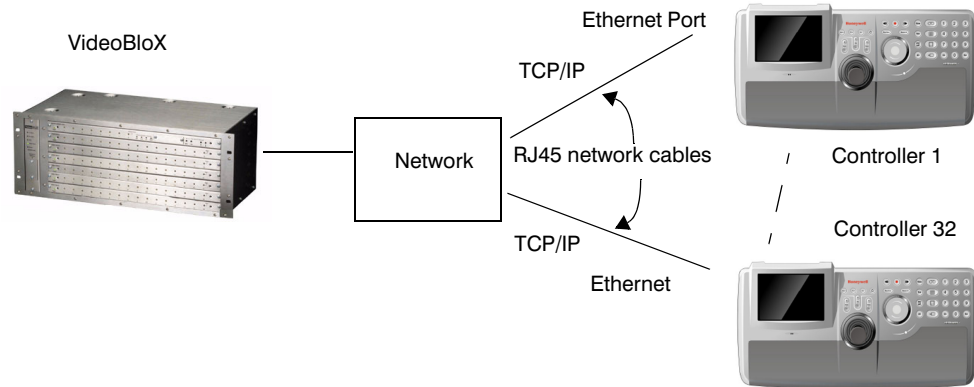

Step 2: Set and Configure for an Ethernet Connection

To set and configure for an Ethernet connection:

Note No entry is required in the baud rate field for Ethernet connections.

1. Apply AC power to the controller after all the devices have been connected correctly.
2. Press **Alt + Clr + Home** keys on the controller to display Login page.
3. Enter the PIN password **3434**.
The **Settings** screen displays.
4. If current mode is **MAXPRO** mode, change it to **VB** mode by pressing the **Mode Maxpro** button and logging into Setting menu again.
5. Press **Hardware Config**.
The current controller setting is displayed.
6. Press **Port Settings** and then **Ethernet**.
The **Ethernet Settings** are displayed.
7. Press **IP Address** and use the numeric keypad or LCD Touch Panel to enter an IP address as required.
8. Press the **Subnet Mask**, using the LCD Touch panel to enter a NetMask as required, you can use Touch Panel as well. Press **Enter**.
9. Press **Default Gateway**. Using the number key or LCD Touch Panel to enter a Gateway as required. Press **Enter**.
10. Press **Sys.Cntl.IP Address**, using the number key or LCD Touch Panel to enter the address of device as required. Press **Enter**.
11. Press **Save** to exit from the Ethernet Settings menu.

Step 3: Configure Address

To configure the keyboard address:

1. Press **Quit** to exit from the Port Settings menu.
2. Press **Keyboard Address** to select an address between 1 and 32 to assign to the controller. You can also use the numeric keypad to enter a number between 1 and 32. However, if you enter a number greater than 32, this operation is invalid.
3. Press **Enter** to save the address and exit the configuration menu.

Step 4: Configure the Controller for VideoBloX Mode

To configure the controller for VideoBloX mode:

1. Press **Users Menu** to display the configuration screen.
2. Refer to *User Menus* on page 62 to configure the device.
3. Press **Home** and then **Quit** to exit when the configuration is finished.

(Optional) Configuring UltraKey Plus Using the Web Browser

Logging onto the Web Browser

1. If not already done, navigate to, or copy and paste, the applicable IP address into your web browser:
 - LAN connections: for example, the default IP is **http://192.168.1.9**.
 - Crossover cable connections - static address: **http://192.168.1.9**.
2. In the **User Name** field enter **Administrator** (case sensitive).
3. In the **Password** field enter **1234** (default).
4. Click **Login**.

Figure 2-7 UltraKey Plus Login Page

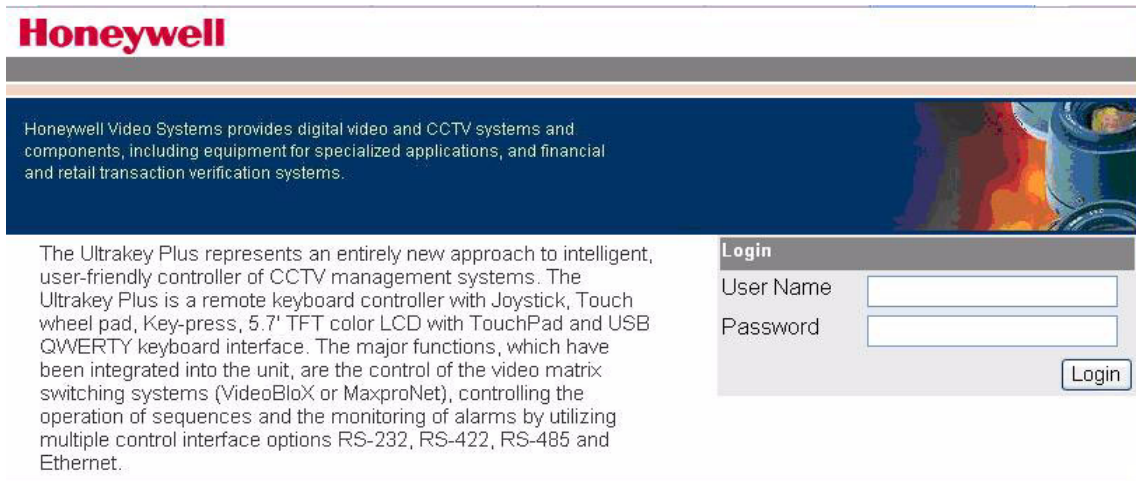

Step 1: Configure UltraKey Plus to VideoBloX Mode

To configure UltraKey Plus to VideoBloX mode:

1. Log onto the web browser.
2. From the top menu, click the **Configuration** tab. See *Figure 2-8*.
3. From the side menu, click the **System Configurations** tab.
4. From the **System Mode** drop down list, select **VideoBloX**.
5. From the **System Language** drop down list, select **English**.
6. Click **Apply** to save the configuration, **Cancel** to exit without saving, or **Default** to restore all factory default values.

Figure 2-8 System Configuration Tab

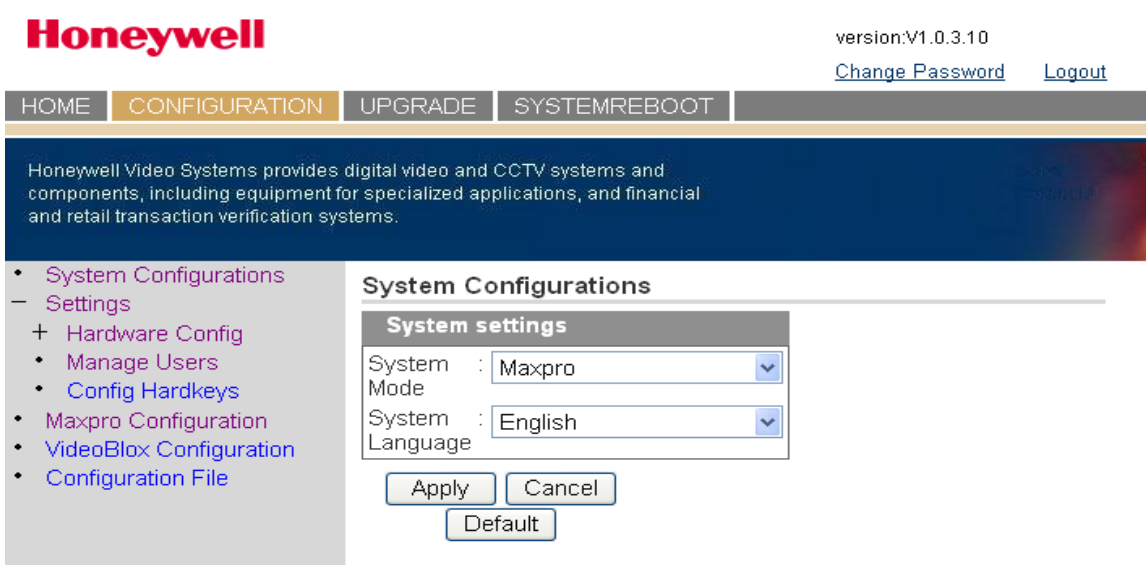

Step 2: Configure VideoBloX Network Settings

To configure VideoBloX network settings:

1. From the side menu, click **VideoBloX Configuration**. See [Figure 2-9](#).
2. Under **Keyboard ID Setting**, enter a number between 1 and 32 to set the controller ID.
3. Under **VB Device Network Setting**, enter the **IP address** and **Port Number** of the VideoBloX system.
4. Click **Apply** to save the configuration, **Cancel** to exit without saving, or **Default** to restore all factory default values.
5. Go to either Step 3A or 3B to configure the system for Serial or Ethernet connections respectively.

Figure 2-9 VideoBloX Configuration Tab

Honeywell version:V1.0.3.10
[Change Password](#) [Logout](#)

HOME CONFIGURATION UPGRADE SYSTEMREBOOT

Honeywell Video Systems provides digital video and CCTV systems and components, including equipment for specialized applications, and financial and retail transaction verification systems.

- System Configurations
- Settings
 - + Hardware Config
 - Manage Users
 - Config Hardkeys
- Maxpro Configuration
- VideoBloX Configuration
- Configuration File

VideoBloX Configuration

Keyboard ID Setting

KeyboardID :
 (Range: 1 ~ 32)

VB Device Network setting

IP address :
 Port number :

Step 3A: Configure the Controller for a Serial Port Connection

To configure the controller for a serial port connection:

1. From the side menu **Settings:Hardware Config**, click **Port Settings**. See [Figure 2-10](#).
2. Under **COM1 Settings**, select the following from each drop down list as required:
 - **Baud Rate:** 1200 bps, 1800, 2400, 4800, 9600, 19200, or 57600
The default for VideoBloX is 19200.
 - **Parity:** none
 - **Stop Bits:** 1 bit
 - **Data Bits:** 8 bits
 - **Serial Mode:** RS422
3. Click **Apply** to save the configuration, **Cancel** to exit without saving or **Default** to restore all factory default values.

Figure 2-10 Port Settings Tab

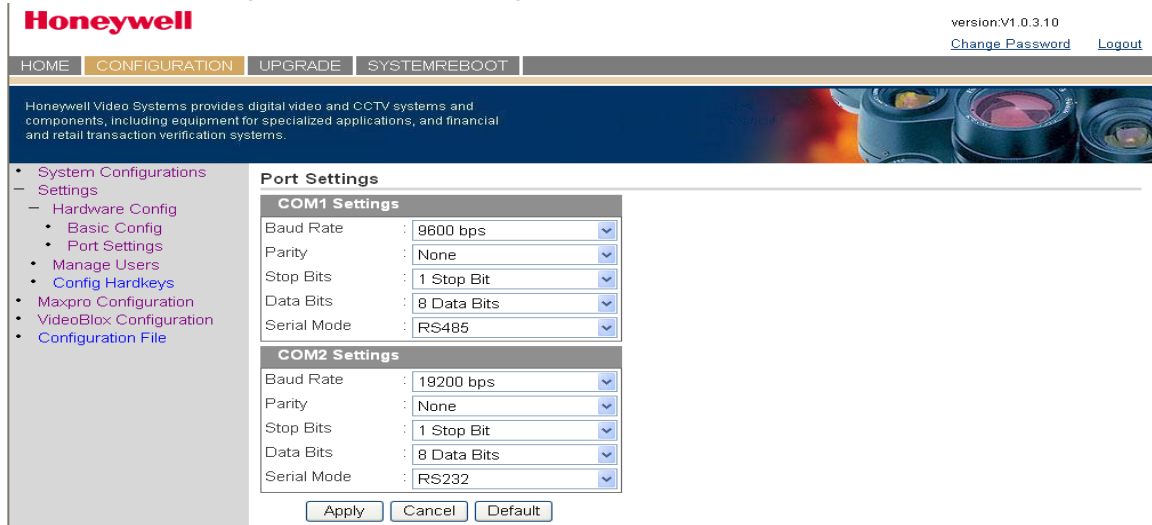

Step 3B: Configure the Controller for an Ethernet Connection

To configure the controller for an Ethernet connection:

1. From the side menu **Settings:Hardware Config**, click **Port Settings**. See [Figure 2-11](#).
2. In each of the fields, enter **IP address**, **subnet mask**, **gateway** and **DNS** values.
3. Click **Apply** to save the configuration, **Cancel** to exit without saving, or **Default** to restore all factory default values.

Figure 2-11 IP Configuration Tab

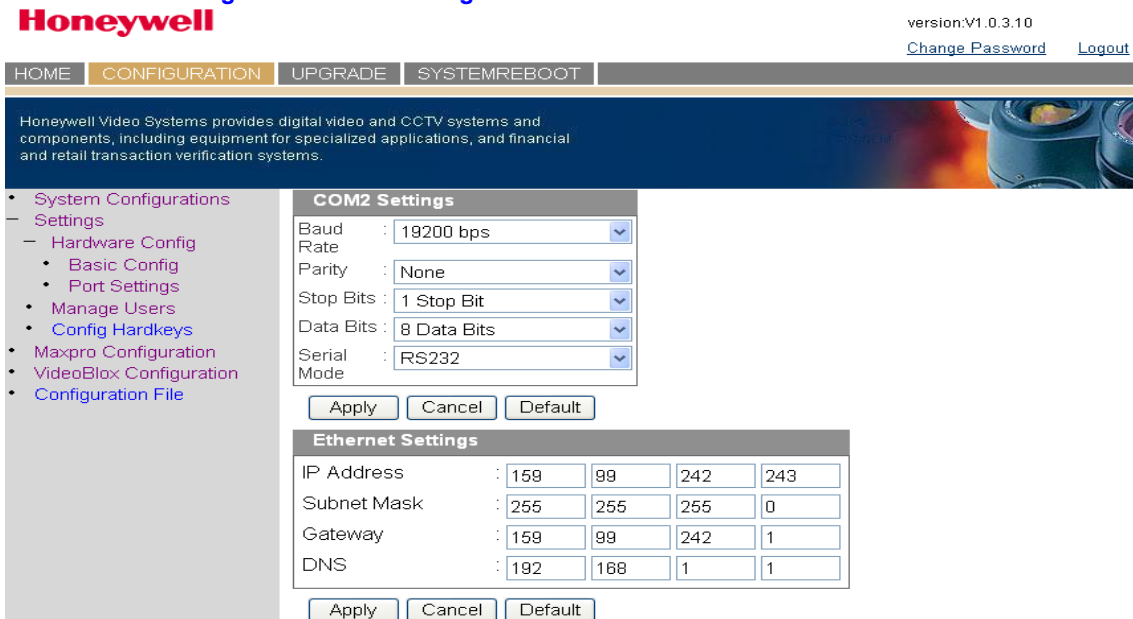

Installing UltraKey Plus with MAXPRO-Net

In this section:

- *Navigating the LCD Configuration Menus*, page 42
- *Installing and Configuring a Serial Connection*, page 43
- *Installing and Configuring an Ethernet Connection*, page 48
- *(Optional) Configuring UltraKey Plus Using the Web Browser*, page 50

Note For all installations, refer to the applicable MAXPRO-Net installation or user guides for more information.

This section explains how to connect the UltraKey Plus controller to MAXPRO-Net and how to enter the basic configuration settings specific to MAXPRO-Net. For other user configurations, see the table of contents.

Navigating the LCD Configuration Menu

See [Using the UltraKey Plus to Navigate the LCD Menus](#) on page 22 for detailed instructions to navigate or [System Administration Using the Controller LCD](#) on page 55 for a configuration menu tree.

Figure 3-1 LCD and LCD Navigation Keys

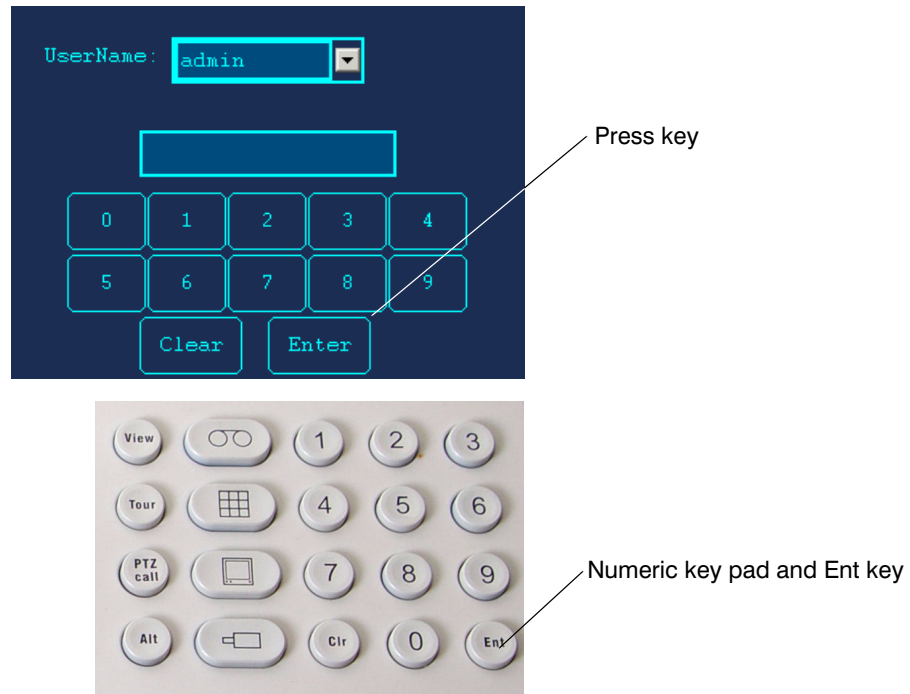

From the MAXPRO Settings menu, you set the following, based on either a Serial or Ethernet connection:

- Keyboard ID (address): Serial or Ethernet connections
- Baud rate: Serial connections only
- Joystick speed: Serial or Ethernet connections
- Server IP: Ethernet connections only
- Server Port: Ethernet connections only
- Serial port mode: Serial connections only

Installing and Configuring a Serial Connection

Step 1: Connect to the UltraKey Plus Using the Serial Port

Note For a list of accessories, see [Shipping Checklist](#) on page 18.

For port connections, see [UltraKey Plus Port Connections and Descriptions](#) on page 19.

Note COM1 (RS422) and COM2 (RS232) are configured using the controller LCD menu and cannot be used at the same time. See [Table 3-1](#) below.

Table 3-1 Serial Port COM1 and COM2 Pin Assignments

Serial Port	Type	Pin	Signal
COM1	RS422	1	RX +
		2	RX -
		5	GND
		7	TX -
		8	TX +
		RS485	7
	8	T/R +	
	COM2	RS232	4
5			GND
6			TXD
RS485		1	T/R +
		2	T/R -

Figure 3-2 RS232 Serial Port Connections

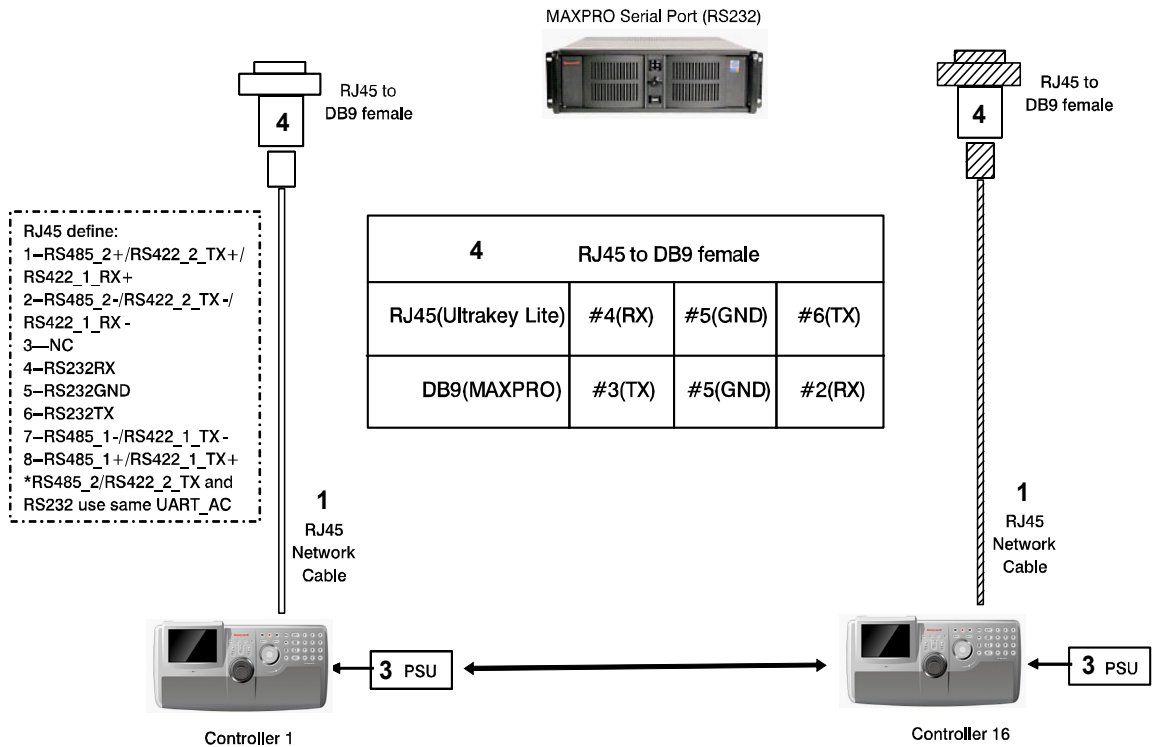

Figure 3-3 RS232 Serial Port Connection and MegaPIT

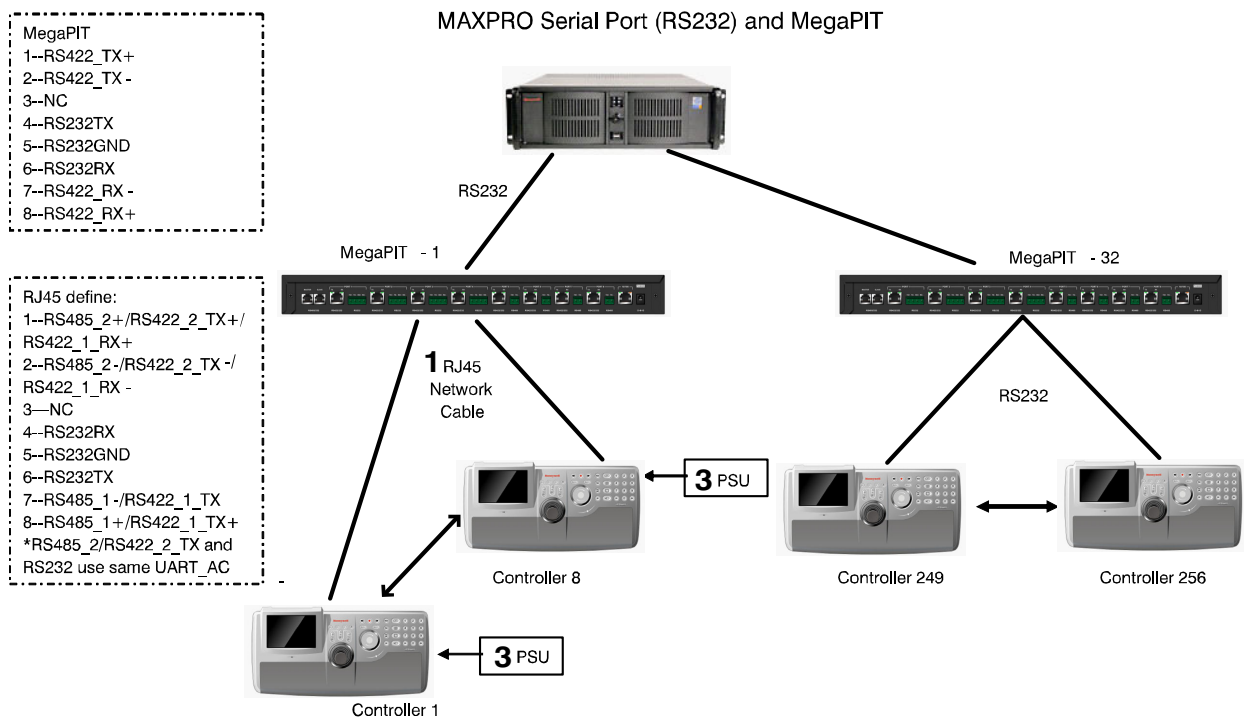
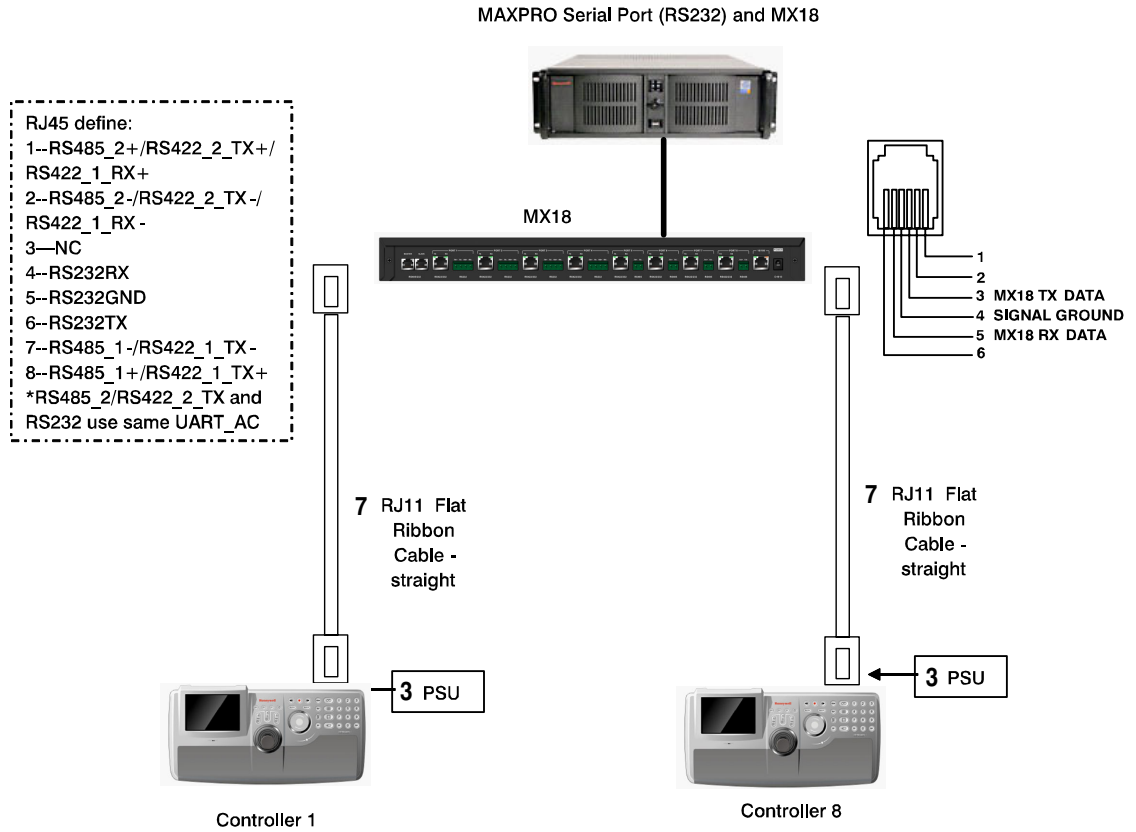

Figure 3-4 RS232 Serial Port Connection and MX18



RS232 Connections with an RJ45 to DB9 Female Adapter

For RS232 connections with an RJ45 to DB9 female adapter:

1. Select the applicable adapter plug and insert it into the AC adapter. Push to click it into place. See [Figure 3-5](#).

Figure 3-5 AC Power Adapter with CEE 7/16 Europlug

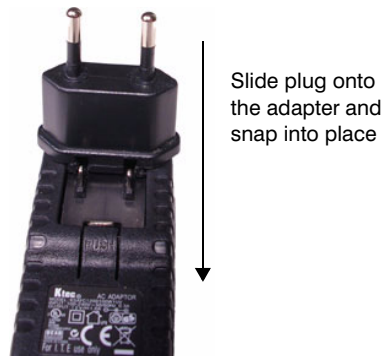

2. Plug the AC adapter into the controller power port and the adapter into a power source.
3. Connect an RJ45 network cable to the controller serial port.

4. Connect the RJ45 network cable to MAXPRO-Net:
 - For backwards compatibility with MAXPRO-Net CPUs, plug the RJ45 to DB9 female adapter included with your shipment into the applicable port of MAXPRO-Net. See [Figure 3-6](#).

Figure 3-6 RJ45 to DB9 Female Adapter (RS232)

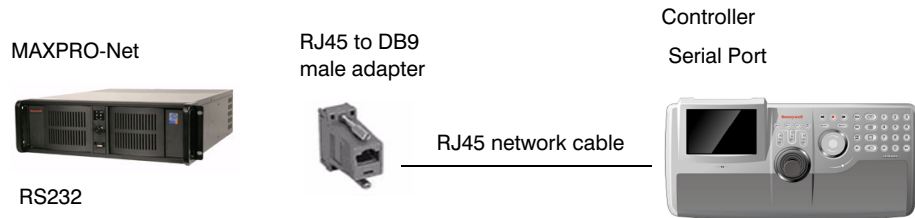

RS422 Connections Using a Converter

To make RS422 connections using a converter:

1. Select the applicable adapter plug and insert it into the AC adapter. Push to click into place. See [Figure 3-5](#).
2. Connect the RS422 cable from the RS422 to RS232 converter to the controller.
3. Connect the RS422 to RS232 converter to the MAXPRO-Net RS232 port. See [Figure 3-7](#).

Figure 3-7 RS422 to RS232 Converter Using the Terminal Box (RS422)

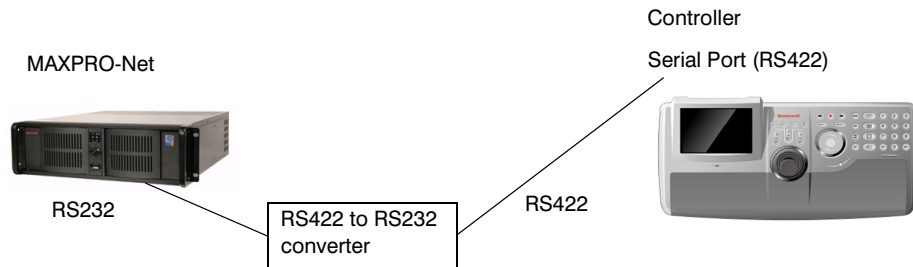

Step 2: Configure Port Settings

To configure port settings:

1. Apply AC power to the controller after all the devices have been connected correctly.
2. Press **Alt + Clr + Home** keys on the controller to display Login page.
3. Enter the PIN password **3434**.
The **Settings** screen displays.
4. If current mode is **VB** mode, change it to **MAXPRO** mode by pressing the **Mode VB** button and logging into the Setting menu again.
5. Press **Hardware Config**.

6. Press **Port Settings** and then either **COM1** or **COM2**.
The Serial Setting menu displays where you can see these settings - serial port mode, baud rate, databit, parity and stop bit.
 - Press **Type** to select **RS422** or **RS232**.
 - Press **Baudrate** to select a baud rate: **1200 bps, 1800, 2400, 4800, 9600, 19200** or **57600**.

Note The default baud rate for most MAXPRO systems is 19200 bps.

- Press **DataBit** to select **7 bit** or **8 bit**.
 - Press **parity** to select **Even, Odd** or **None**.
 - Press **Stop Bit** to select **1 bit** or **2 bits**.
7. Press **Save** to quit the serial port settings.
 8. Press **Ethernet**.
Then the **Ethernet Settings** are displayed.
 9. Press **IP Address** and use the numeric keypad or LCD Touch Panel to enter an IP address, as required.
 10. Press **Save** to exit from the Ethernet Settings menu.

Step 3: Configure Address and Joystick Speed

To configure the controller address and joystick speed:

1. Press **Quit** to exit from **Port Settings** menu.
2. Press **Keyboard Addr** to select an address between 1 and 99 to assign to the controller. You can also use the numeric keypad to enter a number between 1 and 99.
3. Press **Enter** to save the address and exit the configuration menu.
4. Press **Joystick Res** to select **Low** or **High**.
5. Press **Save**.
A message displays confirming the operation.
Press **Yes** to save or **No** to cancel.

Step 4: Configure the Controller for MAXPRO Mode

To configure the controller for MAXPRO mode:

1. Press **Users Menu** to display the configuration screen.
2. See [User Menus](#) on page 62 to configure the device.
3. Press **Home**, and then **Quit** to exit when the configuration is finished.

Installing and Configuring an Ethernet Connection

Step 1: Connect to the UltraKey Plus Ethernet Port

Table 3-2 RJ45 Ethernet Pin Assignments

Port	Pin	Signal
RJ45 Ethernet	1	TX +
	2	TX -
	3	RX+
	6	RX-

To connect to the UltraKey Plus Ethernet port:

1. Plug an RJ45 network cable from the network to the controller Ethernet port. Up to 99 controllers can be connected to the network. See [Figure 3-8](#).
2. Connect MAXPRO-Net to the network. Refer to the applicable [MAXPRO-Net Installation Guide](#) for instructions.

Figure 3-8 Ethernet Port Connections to MAXPRO-Net

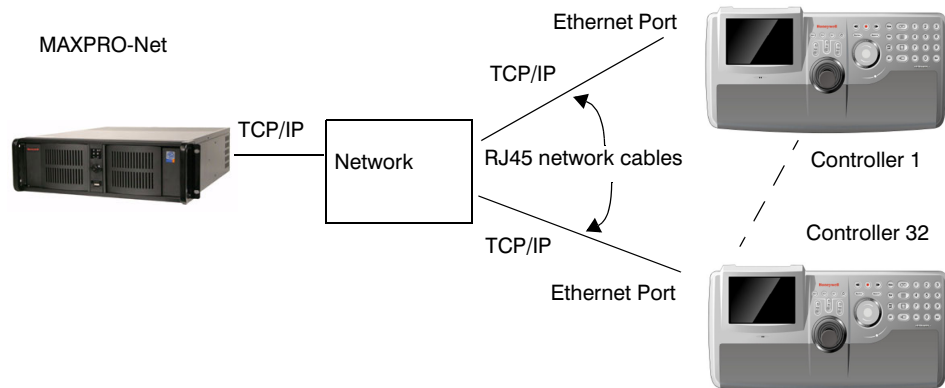

Step 2: Set and Configure for an Ethernet Connection

To set and configure for an Ethernet connection:

1. Apply AC power to the controller after all the devices have been connected correctly.
2. Press **Alt + Clr + Home** keys on the controller to display the Login page.
3. Enter the PIN password **3434**.
The **Settings** screen displays.

4. If the current mode is **VB** mode, change it to **MAXPRO** mode by pressing the **Mode VB** button and logging into the Setting menu again.
5. Press **Hardware Config**.
The current controller setting is displayed.
6. Press **Port Settings** and then **Ethernet**.
The **Ethernet Settings** are displayed.
7. Press **IP Address** and use the numeric keypad or LCD Touch Panel to enter an IP address, as required.
8. Press **Subnet Mask**, and enter a NetMask as required. Press **Enter**.
9. Press **Default Gateway**. Using the number key or LCD Touch Panel to enter a Gateway, as required. Press **Enter**.
10. Press **Sys.Cntl.IP Address**, using the number key or LCD Touch Panel to enter the address of the device, as required. Press **Enter**.
11. Press **Save** to exit from the Ethernet Settings menu.

Step 3: Configure Address and Joystick Speed

To configure the address and joystick speed:

1. Press **Quit** to exit from the Port Settings menu.
2. Press **Keyboard Address** to select an address between 1 and 99 to assign to the controller. You can also use the numeric keypad to enter a number between 1 and 99.
3. Press **Enter** to save the address and exit the configuration menu.
4. Press **Joystick Res** to select **Low** or **High**.
5. Press **Save**.
A message confirming the operation displays.
Press **Yes** to save or **No** to cancel.

Step 4: Configure the Controller for MAXPRO Mode

To configure the controller for MAXPRO mode:

1. Press **Users Menu** to display the configuration screen.
2. See [User Menus](#) on page 62 to configure the device.
3. Press **Home** and then **Quit** to exit when the configuration is finished.

Note Serial Port and Ethernet can **not** be used at the same time in MAXPRO mode.

(Optional) Configuring UltraKey Plus Using the Web Browser

Logging onto the Web Browser

1. If you have not already done so, navigate to, or copy and paste, the applicable IP address into your web browser:
 - LAN connections: for example, the default IP is **http://192.168.1.9**.
 - Crossover cable connections - static address: **http://192.168.1.9**.
2. In the **User Name** field, enter **Administrator** (case sensitive).
3. In the **Password** field, enter **1234** (default).
4. Click **Login**.

Figure 3-9 UltraKey Plus Login Page

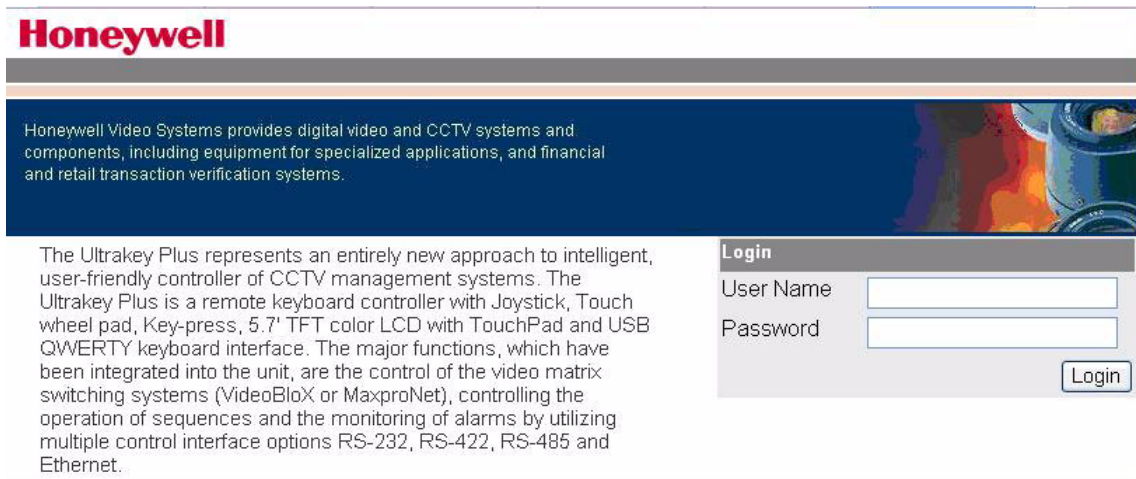

Step 1: Configure UltraKey Plus to MAXPRO Mode

To configure the UltraKey Plus to MAXPRO mode:

1. Log onto the web browser.
2. From the top menu, click the **Configuration** tab. See [Figure 3-10](#).
3. From the side menu, click the **System Configurations** tab.
4. From the **System Mode** drop down list, select **MAXPRO**.
5. From the **System Language** drop down list, select **English**.
6. Click **Apply** to save the configuration, **Cancel** to exit without saving, or **Default** to restore all factory default values.

Figure 3-10 System Configuration Tab

Honeywell version:V1.0.3.10
[Change Password](#) [Logout](#)

HOME CONFIGURATION UPGRADE SYSTEMREBOOT

Honeywell Video Systems provides digital video and CCTV systems and components, including equipment for specialized applications, and financial and retail transaction verification systems.

- System Configurations
- Settings
 - + Hardware Config
 - Manage Users
 - Config Hardkeys
- Maxpro Configuration
- VideoBlox Configuration
- Configuration File

System Configurations

System settings

System Mode : Maxpro

System Language : English

Apply Cancel

Default

Step 2: Configure MAXPRO Network Settings

To configure MAXPRO network settings:

1. From the side menu, click **MAXPRO Configuration**. See [Figure 3-11](#).
2. Under **Keyboard ID Setting**, enter a number between 1 and 99 to set the controller ID.
3. Under **MAXPRO Device Network Setting**, enter the **IP address** and **Port Number** of the MAXPRO-Net Video Matrix system.
4. Click **Apply** to save the configuration, **Cancel** to exit without saving, or **Default** to restore all factory default values.

Figure 3-11 MAXPRO Configuration Tab

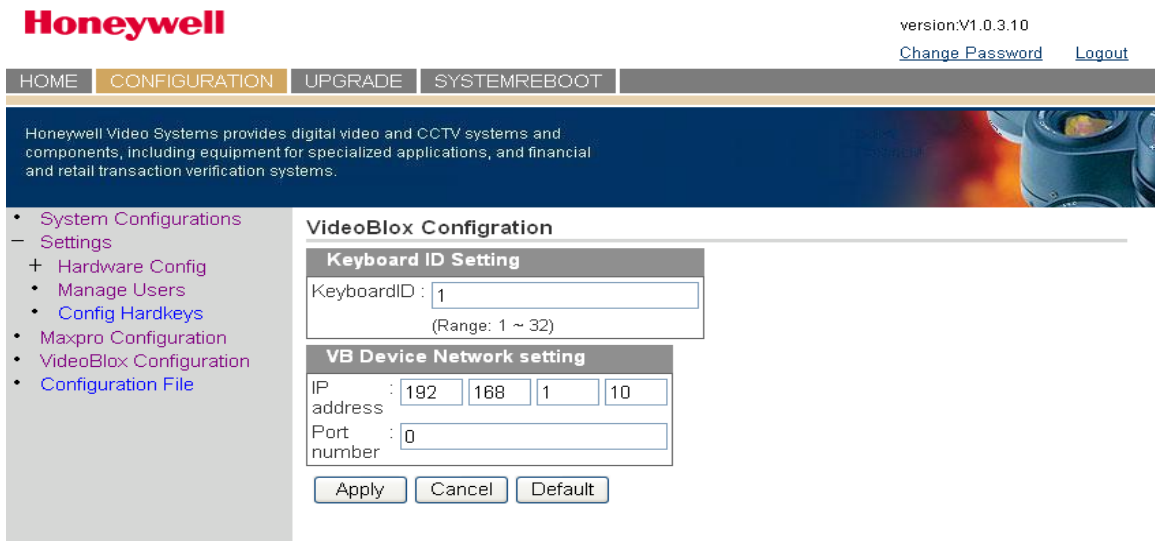

Step 3A: Configure the Controller for a Serial Port Connection

To configure the controller for a serial port connection:

1. From the side menu **Settings:Hardware Config**, click **Port Settings**. See [Figure 3-12](#).
2. Under **COM1 Settings**, select the following from each drop down list as required:
 - **Baud Rate:** 1200, 1800, 2400, 4800, 9600, 19200 or 57600 bps
 - **Parity:** none, even, or odd
 - **Stop Bits:** 1 bit or 2 bits
 - **Data Bits:** 7 bits or 8 bits
 - **Serial Mode:** RS422
3. If required, repeat [step 2](#) for **COM2 Settings** to select **RS232**.
4. Click **Apply** to save the configuration, **Cancel** to exit without saving, or **Default** to restore all factory default values.

Figure 3-12 Port Settings Tab

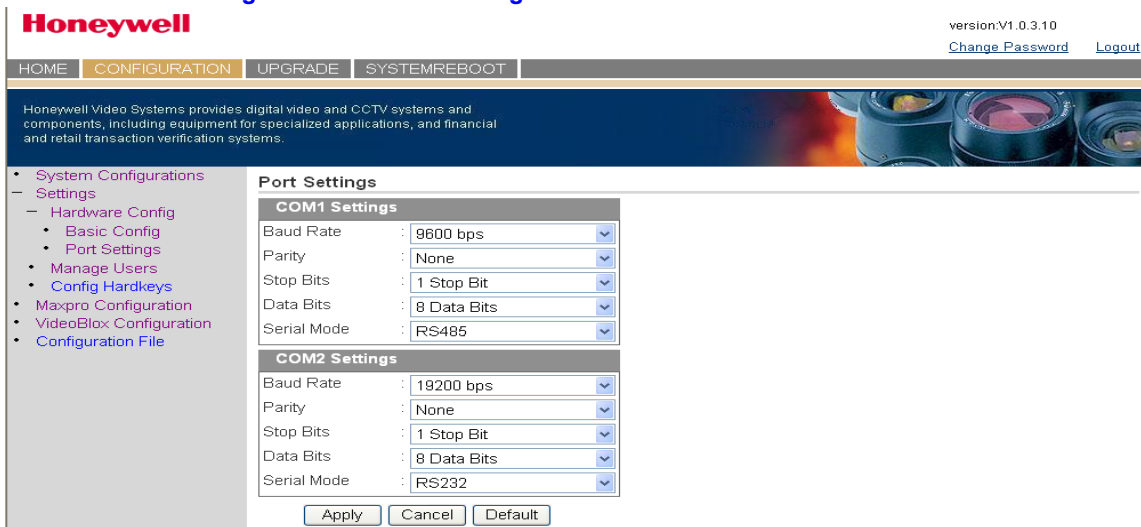

Step 3B: Configure the Controller for an Ethernet Connection

To configure the controller for an ethernet connection:

1. From the side menu **Settings:Hardware Config**, click **Port Settings**. See [Figure 3-13](#).
2. In each of the fields, enter **IP address, subnet mask, gateway** and **DNS** values.
3. Click **Apply** to save the configuration, **Cancel** to exit without saving, or **Default** to restore all factory default values.

Figure 3-13 IP Configuration Tab

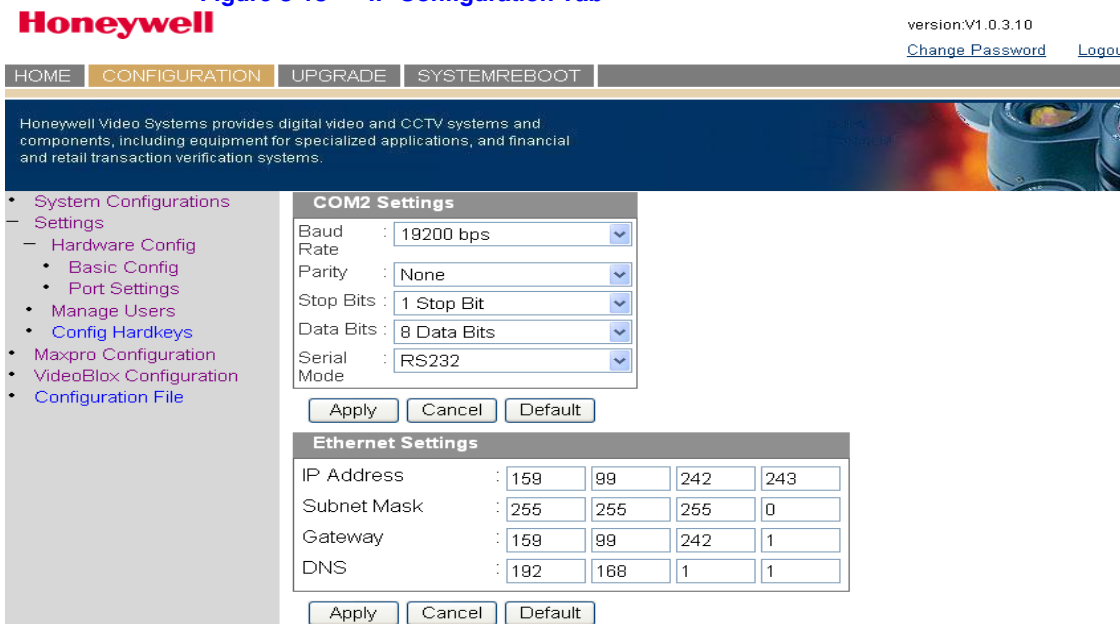

4

System Administration and Troubleshooting

In this section:

- [System Administration Using the Controller LCD](#), page 55
- [System Administration Using the Web Browser](#), page 64

System Administration Using the Controller LCD

Logging on and Navigating to the Settings Menu

1. If you have not already done so, install and connect the controller to a power source.
The UltraKey Plus Welcome displays on the LCD for the first start.
2. Press **Alt + Ctr + Home** keys on the controller to display **Login** pages.
3. Enter the PIN password **3434**.
The **Setting** screen displays.

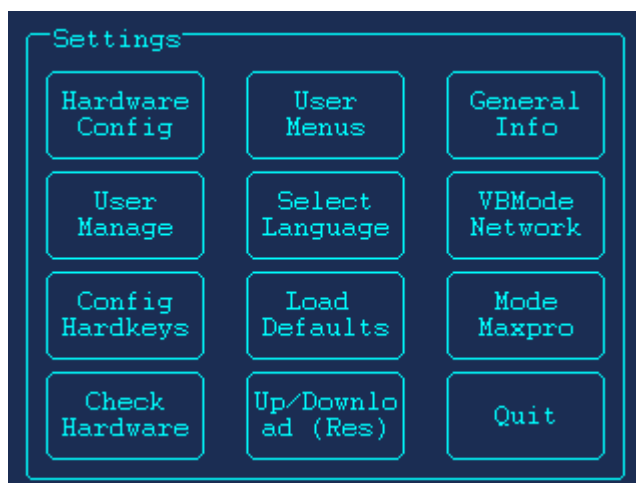

Configuring the Hardware

1. Log onto the controller.
2. From the **Settings** menu, press **Hardware Config**. The Hardware Config submenu displays.

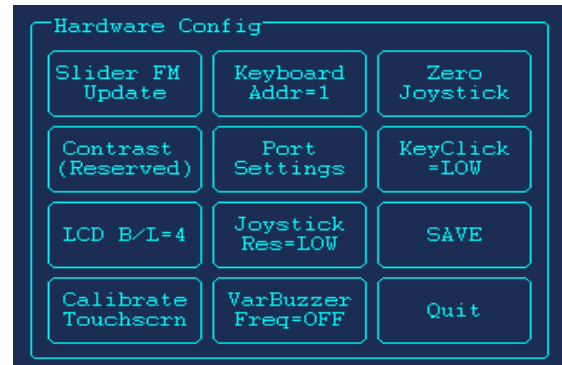

Firmware Update

To update firmware, press **Slider FM Update**. It may take several minutes to update slider firmware.

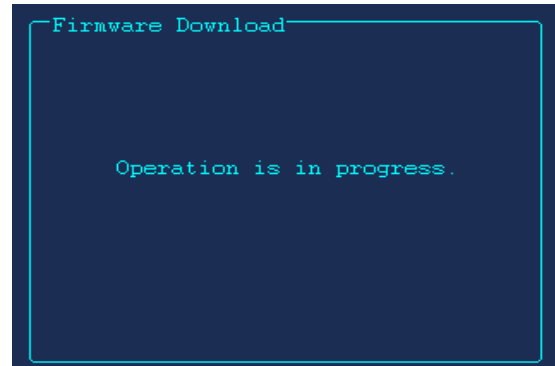

Keyboard Address

To modify/change the keyboard address, press **Keyboard Addr**. Enter the number using either the numeric pad or LCD touch panel. Press **Enter** to save.

- Press **Bkspc** to clear.
- Press **Quit** to cancel.

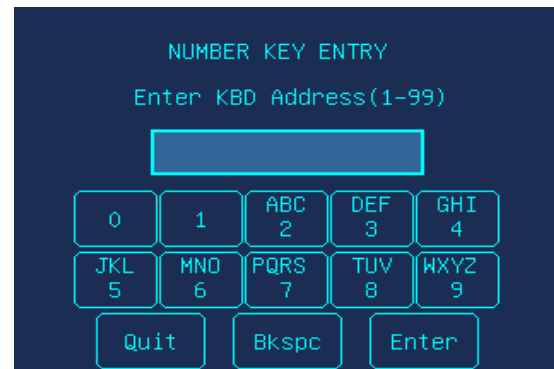

Note The valid KBD Address is between 1 and 32 in VB mode; and 1 and 99 in MAXPRO mode.

Port Settings

To configure port settings, press **Port Settings**.

- Serial Port Settings (COM 1)
Press **COM1** to set type(RS422 or RS485), Baudrate, Databit, Parity and Stopbit.
- Serial Port Settings (COM 2)
Press **COM2** to set type(RS232 or RS485), Baudrate, Databit, Parity and Stopbit.
- Ethernet Settings
Press **Ethernet** and then **IP Address**, **Subnet Mask**, **Default Gateway** and **Sys.Cntl.IP Address** to modify.

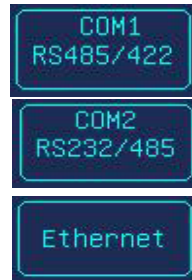

KeyClick

To change the sound volume of key pressing, press **KeyClick**.

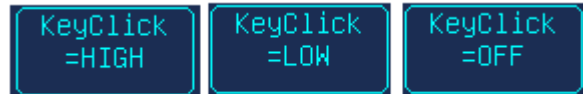

LCD B/L

To adjust LCD backlight, keep pressing the button until a proper level is displayed.

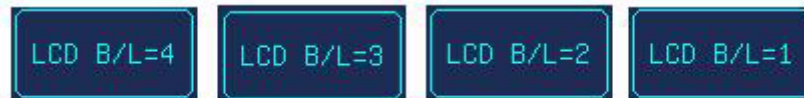

Calibration Touchscreen

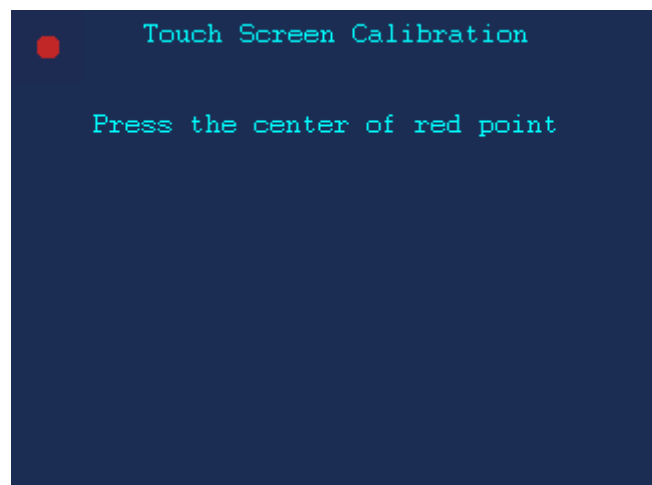

Touch the five red dots on the screen to calibration the touchscreen.

Joystick Res

To adjust joystick speed, press **Joystick Res** to select low or high.



Zero Joystick

To reset the default position of the Joystick, Press **Zero Joystick**.

Managing the Users

1. Log onto the controller.
2. From the **Settings** menu, press **User Manage**. Manage Users menu items displays.

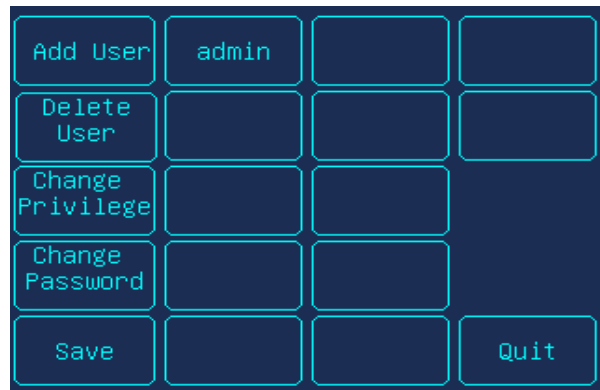

Adding a User

To add a user (for example, ABC), you can follow the steps below.

1. Press **Add User**.
2. Click in the **Username** field, then press **A B C**. Select **Enter** to save and exit.
3. Click in the **Password** field, then enter a password. Select **Enter** to save and exit.
4. Press **Enter**. The new added user **ABC** displays in Manage User menu.
To delete entry, press **Clear**.
To exit the menu, press **Quit**.

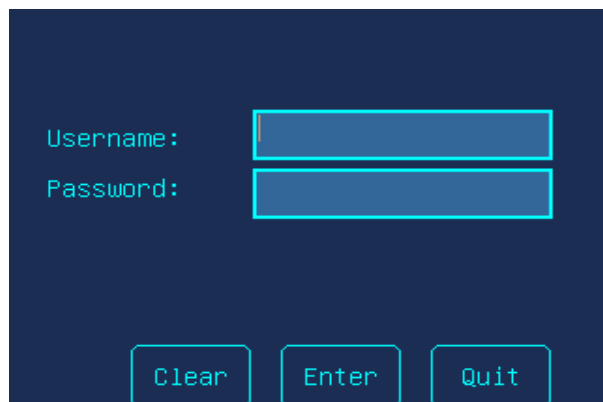

Deleting a User

To delete a user (for example, ABC)

1. Click the user to be deleted.
2. Press **Delete**.
 - Select **OK** to delete the user.
 - Select **Cancel** to cancel the operation.

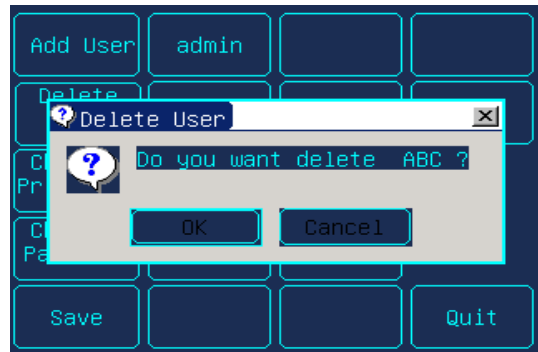

Changing Passwords

To change the password of a user (for example, ABC):)

1. Press the user ABC.
2. Press **Change Password**.
3. Touch the **Password** field and enter the current password. Press **Enter**.
 - A Password Err message displays if you give a wrong password.
4. Touch the **New Password** field, enter the new password, and then press **Enter** to save it.

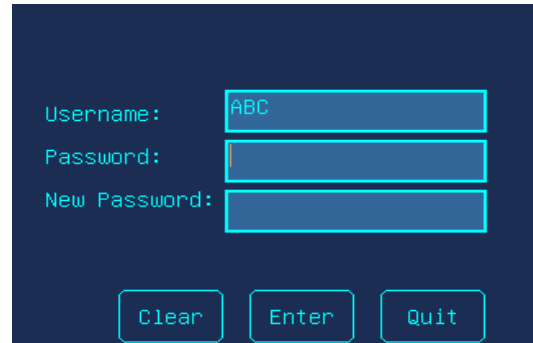

Configuring Hardkeys

To configure hardkeys:

1. Log onto the controller.
2. From the **Settings** menu, press **Config Hardkeys**. The Hardware key config submenu displays.

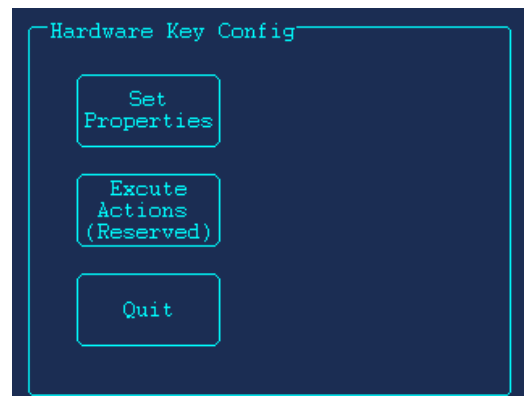

Setting Properties

To set hardkey properties:

1. Press **Set Properties**.
A message pops up and requires you to press a hardkey.
2. Press a hardkey.
3. Press **Max Key** to start operating or press **Cancel** to quit.
The scroll menu shows all types of executive actions you can do. You can use any of the methods below to search the executive actions.
 - Touch the up/down arrow of the menu to scroll the items and press the item directly to complete selection.
 - Press **Prev/Next** to scroll the item one by one.
 - Press **PG UP/PG DOWN** to scroll the items page by page. Then touch the item directly.
 - Press **GotoKey** and enter the ID of the action. The item will display on the menu immediately.
4. When the executive action is displays, press **Select Action** to confirm. Then you can continue adding actions to the hardkey following step 3,4 or skip to step 5 to finish.
 - Press **Prev Step/Next Step** to review the previous/next action relative to the current action.
 - Press **Ins Actio** to select another action put behind the current action.
 - Press **Del Actio** to delete the current step of action.
5. Press **Edit Name** to give a new name to the hardkey, then press **Enter** to save and quit.

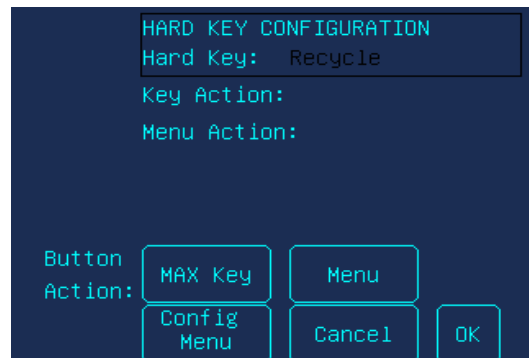

Adding a New Key

To add a new key.

1. Press **New Key** to enter the key number and key action name, then press **Enter** to save and quit.
 - Enter the key number. Just type the number and press **Enter** to save.
 - Enter a new name for the key action. You can press **Down/Up** to select the characters. Press **Enter** to save.
To delete a key, press **Del Key**.
2. Press **OK** to save and exit.

Modifying a Menu

From the hardkey configuration menu, you can modify the menus. For detailed information on how to modify a menu, see [User Menus](#), page 62.

1. Press **Menu** to edit the system menus.
2. To edit the menu name:
 - a. Select it in the scroll window, press **Edit Name** and modify as desired.
 - b. Press **Enter** to save or **Quit** to cancel.
3. To generate a new menu, press **New Menu**.
4. To delete a menu, select it and then press **Del Menu** to delete it from the system.
5. To change the appearance of the menu button, press **Edit Menu**.
6. Press **OK** to save and exit.

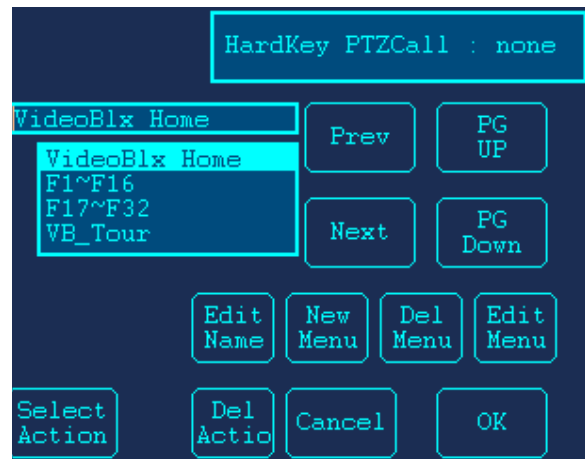
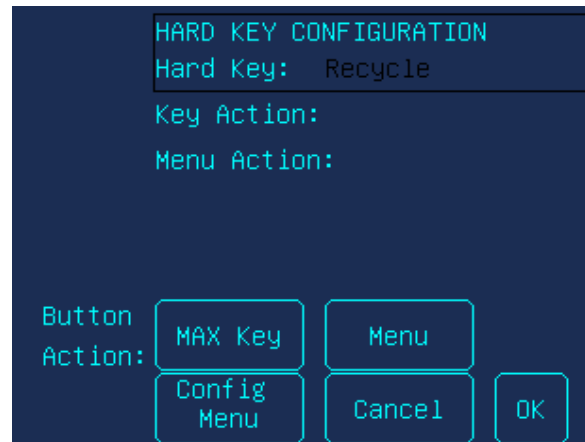

Executing Action

Press **Execute Actions** and then the hardkey. The system starts executing the hardkey's functions.

Checking the Hardware

To check the hardware:

1. Log onto the controller.
2. From the **Settings** menu, press **Check Hardware**.
The Check Controls submenu displays.

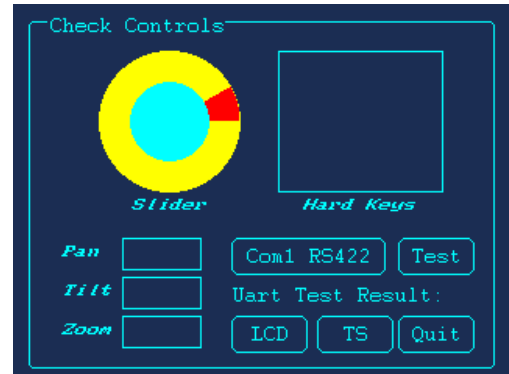

- **Key:** When you press a key, the key value and its status is displayed on LCD.
 - **Joystick:** When you move the joystick, values which present the PTZ positions of the joystick are displayed on the LCD.
 - **Slider:** When you rotate the touch pad, specific values are displayed on the LCD.
 - **LCD:** Press **LCD** and the LCD will appear white. It will appear black, red, green and blue when you touch the screen each time. You can use this method to check whether there is a dead pixel on the screen.
 - **TS:** Press **TS** and a grid-map displays. You can touch each grid to check whether the LCD is working well.
3. Press **Quit** to exit.

User Menus

To change the starting menu of the controller:

1. Log onto the controller.
2. From the **Settings** menu, press **User menus**.
The User menu submenu displays.
3. Press the button to be modified except **Home** on the LCD.

Home						
Back	Cam	Mon	VCR	1	2	3
F 1~16	Seq	Menu	Alarm	4	5	6
F 17~32		Up		7	8	9
	BCD	Down	Right	Prev	0	Next
Login	Backspace		Clear		Enter	

4. The two buttons of the top line indicates the two options for the button size in the pop up menu. Press one to set the button size.
5. To set the button top text, press **Top Text** and **Enter** text. The text you typed displays on the top of the button.
6. To set the button bottom text, press **Bottom Text** and **Enter** text. The text displays on the bottom of the button.
7. Press **MaxKey** and set the button function.
8. Press **Menu** to modify the system menus.

Note To set the **Maxkey** and **Menu** in step 7 and 8, see [Configuring Hardkeys](#), page 59 for more detailed information.

9. Press **BG Color/Text Color** to set the color of button/text.
10. To delete the button, press **Delete Button**.
11. Press **OK** to save and exit.
12. When you have finished the setting, press **Home** to exit.

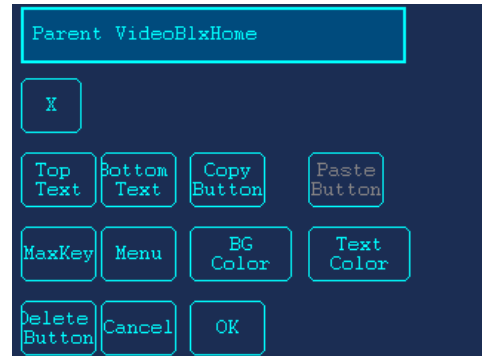

Selecting the Language

1. Log onto the controller.
2. From the **Settings** menu, press **Select Language**.
3. You can choose the language if there is any available options. The default language is English.

Loading Defaults

1. Log onto the controller.
2. From the **Settings** menu, press **Load Defaults**.
The detail information displays.
3. Press one of the default menus.
The confirm message displays.
 - Press **Yes** to load default configuration. Then the system restarts automatically.
 - Press **No** to cancel and quit.

General Information

To view general information about the controller:

1. Log onto the controller.
2. From the **Settings** menu, press **General Info**. The controller's general information displays.
3. Press any place on the LCD to return to the previous menu.

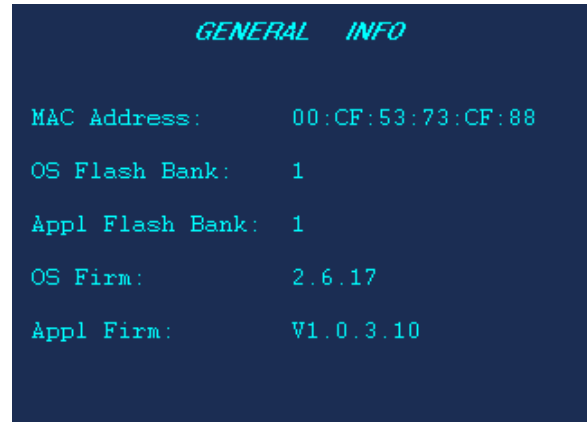

VB Communication Mode

1. Log onto the controller.
2. From the **Settings** menu, press **VBMode** to set the controller to VB Serial mode or VB Network mode.

System Mode

1. Log onto the controller.
2. From the **Settings** menu, press **Mode VB** or **Mode MAXPRO** to change the mode.

System Administration Using the Web Browser

Logging onto the Web Browser

1. If not already done, navigate to, or copy and paste, the applicable IP address into your web browser:
 - LAN connections: for example, **http://192.168.1.9**.
 - Crossover cable connections - static address: **http://192.168.1.9**.
2. In the **User Name** field enter **Administrator** (case sensitive).

3. In the **Password** field enter **1234** (default).
4. Click **Login**.

Configuring the Hardware

1. Log onto the web browser.
2. From the side menu **Settings:Hardware Config**, click **Basic Config**. See 4-1.
3. Select **Background Light** from the drop down list. Options are **Off**, **Low**, **Middle** or **High**.
4. In the **Keyboard Address** field, you can enter the number between 1 to **32**.
5. Select **Joystick Res** from the drop down list. Options are **Low** or **High**.
6. Select **VarBuzzer Freq** from the drop down list. Options are **Off** or **On**.
7. Select **KeyClick** form the drop down list. Options are **Off** , **Low** and **High**.
8. Click **Save** to save the configuration or **Quit** to exit without saving.

Figure 4-1 Configure Hardware

The screenshot shows the Honeywell web interface. At the top left is the Honeywell logo. At the top right, it says 'version:V1.0.3.10' and has links for 'Change Password' and 'Logout'. Below the header is a navigation bar with 'HOME', 'CONFIGURATION', 'UPGRADE', and 'SYSTEMREBOOT'. The main content area has a sidebar menu on the left with 'System Configurations' and 'Settings' expanded to show 'Hardware Config', 'Basic Config', 'Port Settings', 'Manage Users', 'Config Hardkeys', 'Maxpro Configuration', 'VideoBlox Configuration', and 'Configuration File'. The main content area is titled 'Hardware Configuration' and contains a 'Basic Hardware Config' form with the following fields: Background Light (High), Keyboard Address(1-32) (1), Joystick Res (Low), VarBuzzer Freq (Off), and KeyClick (Low). There are 'Save' and 'Quit' buttons at the bottom of the form.

Managing the Users

1. Log onto the web browser.
2. From the side menu **Settings**, click **Manage Users**. See 4-2
3. Press **Add**, enter the **User name** and **Password**. Click **Apply** to Save the operation or **Cancel** to quit editing.
4. To delete a user, select the user in the user list and press **Delete**. A message Are you sure you want to delete this user? displays. Press **Yes** to confirm or **No** to cancel.

5. To change a user password:
 - a. Select the user in the user list.
 - b. In the **Change Password** section, enter the old password and the new password.
 - c. Press **Apply** to save the operation or **Cancel** to quit editing.

Figure 4-2 Manage Users

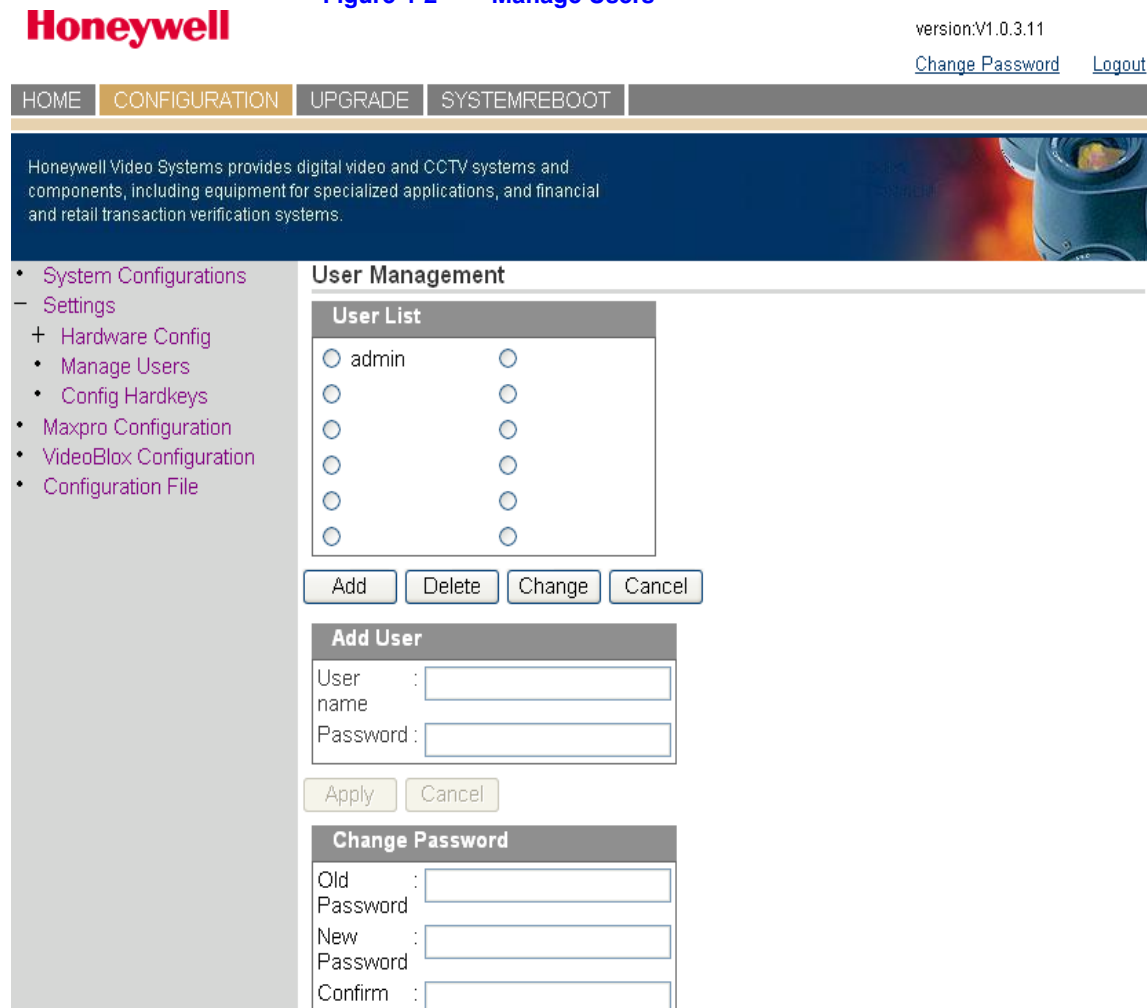

Configuring Hardkeys

1. Log onto the web browser.
2. From the side menu **Settings**, click **Config Hardkey**. See [Figure 4-3](#).
3. Select the Hardkey to be configured from the drop-down list (for example, **_KEY_PLAY**).
4. Select the keys which are linked to the keys to be configured (for example, **Alarm ACK**). Then click **Add** < .
5. Click **Apply** for the configuration to take effect.

Figure 4-3 Configuring Hardkey

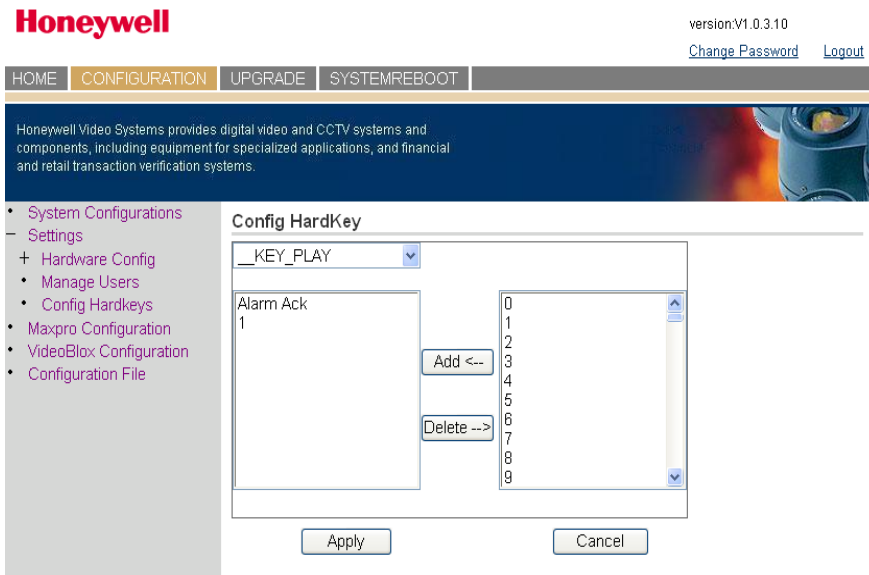

Configuring File

1. Log onto the web browser.
2. From the side menu **Settings**, click **Configuration File**. See *Figure 4-4* .
3. Right-click **ConfigFile** under the green arrow. Then select **Save Target AS...** to save the desired file.
4. Click **Browse...** and select the files you saved in step 3.
5. Click **Send**. Then wait for a few minutes for the system to upload and configure files.

Figure 4-4 Configuring File

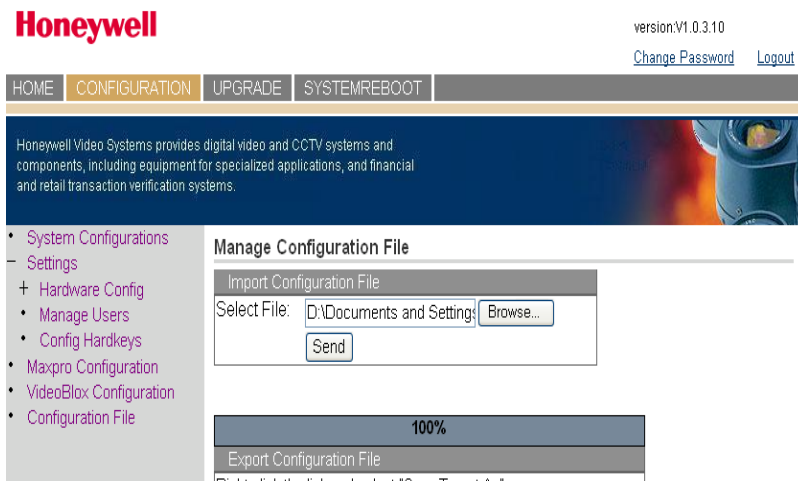

Upgrading the UltraKey Plus Firmware

1. Log onto the web browser.
2. From the top menu, click the **Upgrade** tab.
The warning message Please make sure the network connection is connected during system upgrading displays. See *Figure 4-5*.
3. Click **OK**.
The **Software Upgrade** menu opens.
4. **Select a Folder** from the drop-down list: **Application, FPGA, Kernel, BL or FS**.
5. In the **Select File** field, click **Browse**. Navigate to the file and click **OK**.
6. Click **Send** to start the upgrade process.
The Upgrade Status window opens. Messages display to indicate when the old files are being erased and the new files are being copied.
7. When the process is complete, the message Upgrade success displays and the system reboots.

Figure 4-5 Software Upgrade Warning Message

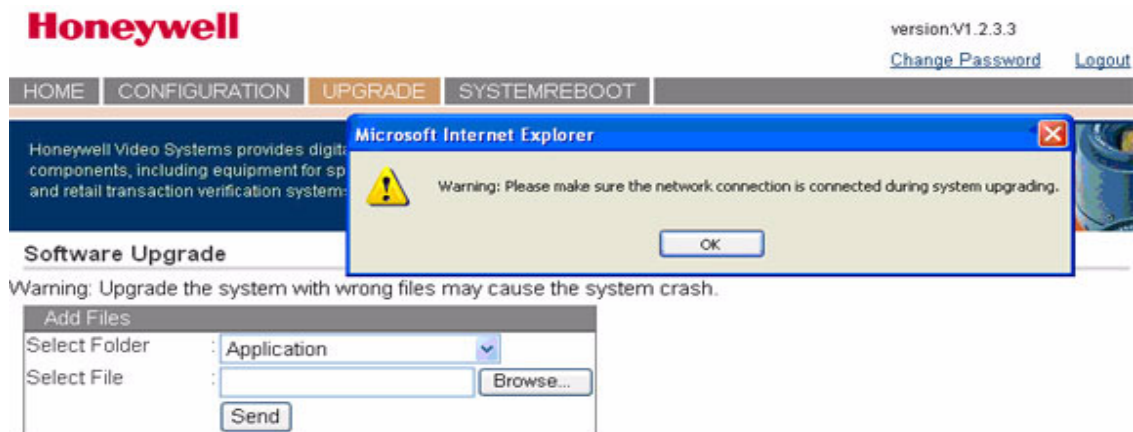

Rebooting UltraKey Plus

1. Log onto the web browser.
2. From the top menu, click the **System Reboot** tab.
The **Reboot System** window opens.
3. Click **Reboot** to continue or click another tab or Logout to exit without rebooting.

Figure 4-6 System Reboot

Honeywell version:V1.2.3.3
[Change Password](#) [Logout](#)

HOME CONFIGURATION UPGRADE **SYSTEMREBOOT**

Honeywell Video Systems provides digital video and CCTV systems and components, including equipment for specialized applications, and financial and retail transaction verification systems.

Reboot System

Are you sure you want to reboot the system?

Changing the UltraKey Plus Password

1. Log onto the web browser.
2. In the upper right corner, click **Change Password**. See [Figure 4-7](#).
3. In the **Old Password** field, enter the current password.
4. In the **New Password** field, enter a new password.
5. Enter the new password in the **Confirm New Password** field.
6. Click **Apply** to set the new password or **Cancel** to exit without changing it.

Figure 4-7 Change Password Page

Honeywell version:V1.2.3.3
[Change Password](#) [Logout](#)

HOME CONFIGURATION UPGRADE **SYSTEMREBOOT**

Honeywell Video Systems provides digital video and CCTV systems and components, including equipment for specialized applications, and financial and retail transaction verification systems.

Change Password

Old Password :

New Password :

Confirm New Password :

Index

C

controller

- configuring address, MAXPRO-Net [47](#), [49](#)
- configuring address, VideoBloX [34](#)
- configuring Ethernet connection, MAXPRO-Net [53](#)
- configuring serial port connection, MAXPRO-Net [52](#)
- configuring VideoBloX mode [34](#)
- configuring with web browser [37](#)
- configuring with web browser, MAXPRO-Net [50](#)
- configuring, MAXPRO mode [47](#), [49](#)
- configuring, VideoBloX mode [37](#)
- connecting to VideoBloX [31](#)
- connecting via serial port, MAXPRO-Net [43](#)
- logging on [21](#)
- navigating LCD menus [22](#)
- navigation controls [23](#)

E

Ethernet port

- configuring connection, MAXPRO-Net [48](#)
- configuring controller, VideoBloX [40](#)
- configuring, VideoBloX [36](#)
- connecting to controller, MAXPRO-Net [48](#)
- connecting, VideoBloX [35](#)
- described [20](#)
- RJ45 pin assignment, VideoBloX [35](#)

J

joystick

- configuring speed, MAXPRO-Net [47](#), [49](#)

K

key functions

- MAXPRO-Net [26](#)
- VideoBloX [24](#)

keyboard address

- configuring, VideoBloX [37](#)

L

LCD

- navigating menus [22](#)
- navigation keys, MAXPRO-Net [42](#)
- navigation keys, VideoBloX [30](#)

M

MAXPRO-Net

- configuring controller [47](#), [49](#)
- configuring controller address [47](#), [49](#)
- configuring controller with web browser [50](#)
- configuring Ethernet connection [48](#)
- configuring Ethernet connection with web browser [53](#)
- configuring joystick speed [47](#), [49](#)
- configuring network settings with web browser [51](#)
- configuring ports [46](#)
- configuring serial port connection [52](#)
- connecting to controller [43](#)
- connecting to controller via Ethernet port [48](#)
- key functions [26](#)
- LCD navigation keys [42](#)
- RJ45 Ethernet pin assignments [48](#)
- RS232 serial port connections [44](#)
- serial port pin assignments [43](#)

N

navigation controls [23](#)

network settings

- configuring with web browser, MAXPRO-Net [51](#)
- configuring with web browser, VideoBloX [39](#)

P

pin assignments

- RJ45 Ethernet, MAXPRO-Net [48](#)
- serial port, VideoBloX [31](#)

ports

- configuring for VideoBloX [33](#)
- configuring serial port, VideoBloX [39](#)

configuring settings, MAXPRO-Net [46](#)
configuring, MAXPRO-Net [46](#)
DC power [19](#)
Ethernet configuring, VideoBloX [36](#)
Ethernet to controller, MAXPRO-Net [48](#)
Ethernet, configuring with web browser,
VideoBloX [40](#)
Ethernet, described [20](#)
location [19](#)
RS232 serial port, MAXPRO-Net [44](#)
RS232/422/485, described [20](#)
serial, connecting, MAXPRO-Net [43](#)
serial, pin assignments, MAXPRO-Net [43](#)
USB [20](#)

R

RJ45 Ethernet, pin assignments, MAXPRO-Net [48](#)
RS232 serial port
connections, MAXPRO-Net [44](#)
described [20](#)
RS422/RS485 serial port, described [20](#)

S

serial port
configuring controller, VideoBloX [39](#)
connecting with VideoBloX [31](#)

pin assignments, MAXPRO-Net [43](#)
RS232/RS422/RS485, described [20](#)
shipping checklist [18](#)
specifications [17](#)

U

USB port [20](#)

V

VideoBloX
configure Ethernet port [36](#)
configuring controller [34](#), [37](#)
configuring controller address [34](#)
configuring controller with web browser [40](#)
configuring controller, web browser [39](#)
configuring keyboard address [37](#)
configuring network settings, web browser [39](#)
configuring ports [33](#)
configuring with web browser [37](#)
connecting ethernet port [35](#)
connecting via serial port [31](#)
key functions [24](#)
LCD navigation keys [30](#)
RJ45 pin assignment [35](#)
serial port pin assignments [31](#)

Honeywell Security Group (Head Office)

2700 Blankenbaker Pkwy, Suite 150
Louisville, KY 40299, USA
www.honeywellvideo.com
☎ +1.800.796.2288

Honeywell Security Group Europe/South Africa

Aston Fields Road, Whitehouse Industrial Estate
Runcorn, Cheshire, WA7 3DL, UK
www.honeywell.com/security/uk
☎ +44.01928.754028

Honeywell Security Group Caribbean/Latin America

9315 NW 112th Ave.
Miami, FL 33178, USA
www.honeywellvideo.com
☎ +1.305.805.8188

Honeywell Security Group Pacific

Level 3, 2 Richardson Place
North Ryde, NSW 2113, Australia
www.honeywellsecurity.com.au
☎ +61.2.9353.7000

Honeywell Security Group Asia

35F Tower A, City Center, 100 Zun Yi Road
Shanghai 200051, China
www.asia.security.honeywell.com
☎ +86 21.5257.4568

Honeywell Security Group Middle East/N. Africa

Post Office Box 18530
LOB Building 08, Office 199
Jebel Ali, Dubai, United Arab Emirates
www.honeywell.com/security/me
☎ +971.04.881.5506

Honeywell Security Group Northern Europe

Ampèrestraat 41
1446 TR Purmerend, The Netherlands
www.honeywell.com/security/nl
☎ +31.299.410.200

Honeywell Security Group Deutschland

Johannes-Mauthe-Straße 14
D-72458 Albstadt, Germany
www.honeywell.com/security/de
☎ +49.74 31.8 01.0

Honeywell Security Group France

Immeuble Lavoisier
Parc de Haute Technologie
3-7 rue Georges Besse
92160 Antony, France
www.honeywell.com/security/fr
☎ +33.(0).1.40.96.20.50

Honeywell Security Group Italia SpA

Via della Resistenza 53/59
20090 Buccinasco
Milan, Italy
www.honeywell.com/security/it
☎ +39.02.4888.051

Honeywell Security Group España

Mijancas 1. 3a planta
P.Ind. Las Mercedes
28022 Madrid, Spain
www.honeywell.com/security/es
☎ +34.902.667.800

Honeywell

www.honeywellvideo.com
+1.800.796.CCTV (North America only)
HVSsupport@honeywell.com

Document 800-02573 — Rev B — 11/2009

© 2009 Honeywell International Inc. All rights reserved. No part of this publication may be reproduced by any means without written permission from Honeywell. The information in this publication is believed to be accurate in all respects. However, Honeywell cannot assume responsibility for any consequences resulting from the use thereof. The information contained herein is subject to change without notice. Revisions or new editions to this publication may be issued to incorporate such changes.

Free Manuals Download Website

<http://myh66.com>

<http://usermanuals.us>

<http://www.somanuals.com>

<http://www.4manuals.cc>

<http://www.manual-lib.com>

<http://www.404manual.com>

<http://www.luxmanual.com>

<http://aubethermostatmanual.com>

Golf course search by state

<http://golfingnear.com>

Email search by domain

<http://emailbydomain.com>

Auto manuals search

<http://auto.somanuals.com>

TV manuals search

<http://tv.somanuals.com>