



ScanPal™ EDA61K Series

Mobile Computer powered by Android™

Quick Start Guide

Out of the Box

Make sure that your shipping box contains these items:

- ScanPal Mobile Computer
(Model EDA61K-0 or EDA61K-1)
- Rechargeable 3.6 V Li-ion battery
- Product documentation

If you ordered accessories for your mobile computer, verify that they are also included with the order. Be sure to keep the original packaging in case you need to return the mobile computer for service.

Note: *EDA61K-0 models do not include a WWAN radio.*

Memory Card Specifications

Honeywell recommends the use of Single Level Cell (SLC) industrial grade microSD™ or microSDHC™ memory cards with ScanPal mobile computers for maximum performance and durability. Contact a Honeywell sales representative for additional information on qualified memory card options.

Mobile Computer Features

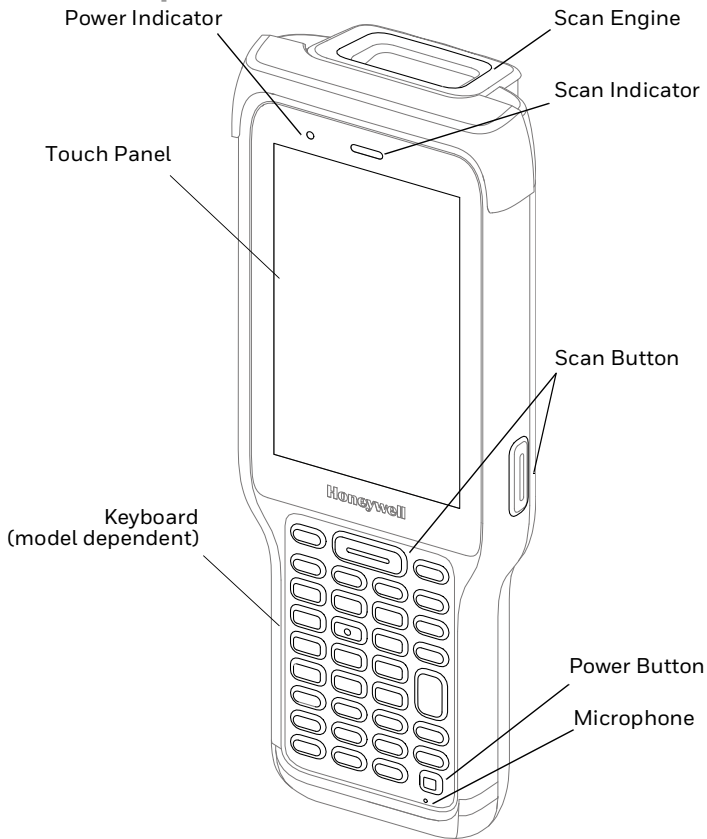

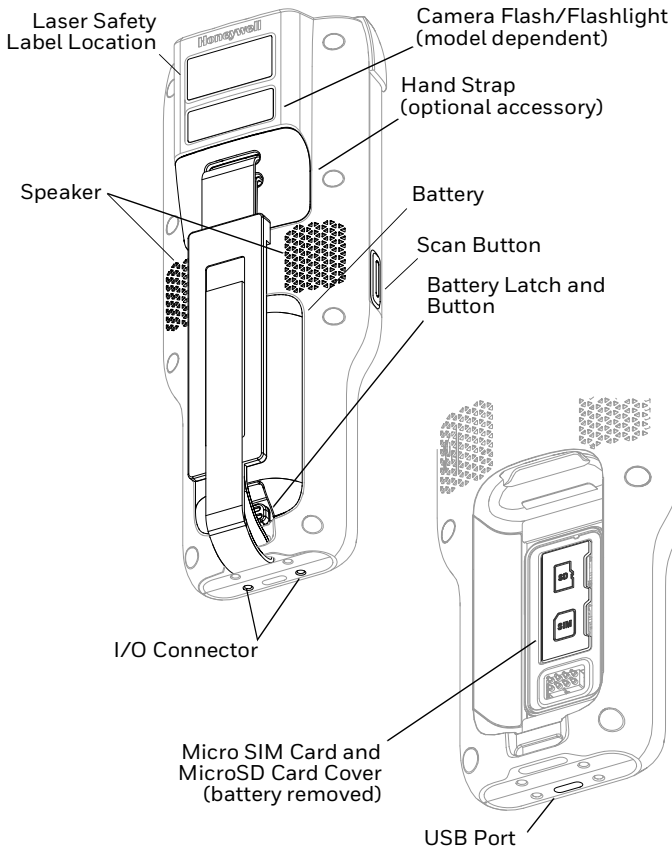

Install a Micro SIM Card

Only EDA61K-1 (WWAN) models support micro SIM card use for cellular phone features.

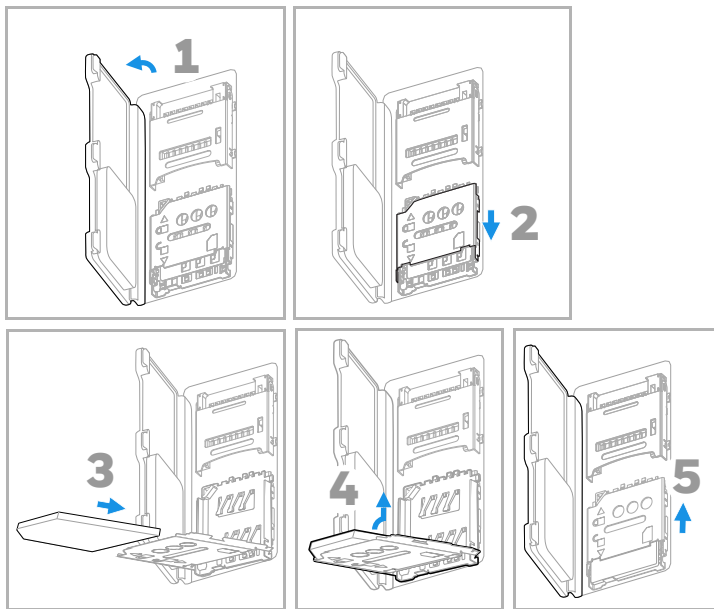

Note: Always power off the computer before attempting to install or remove a card.

Install a microSD Card (Optional)

Note: Format the microSD card before initial use.

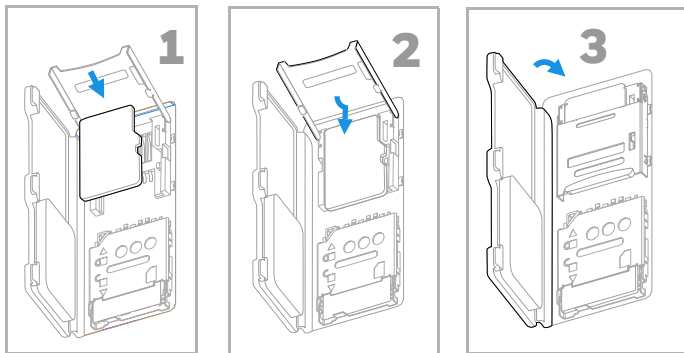

Note: Always power off the computer before attempting to install or remove a card.

Install the Battery

The EDA61K ships with a Li-ion 3.6 V battery manufactured for Honeywell International Inc.



We recommend use of Honeywell Li-ion battery packs. Use of any non-Honeywell battery may result in damage not covered by the warranty.

Ensure all components are dry prior to placing the battery in the computer. Mating wet components may cause damage not covered by the warranty.

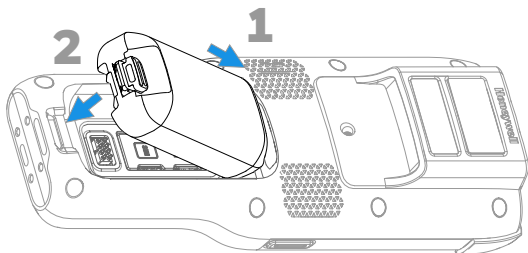

Install Hand Strap (Optional Accessory)

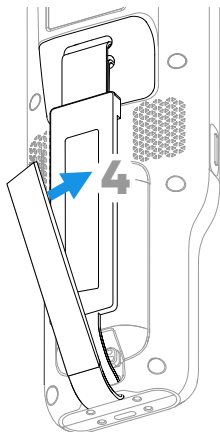
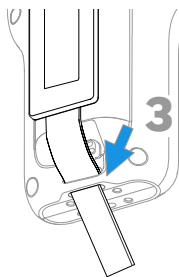
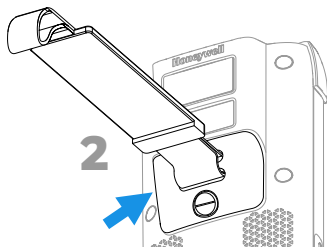
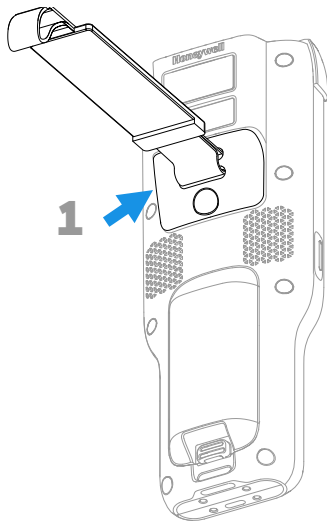

Charge the EDA61K

The EDA61K mobile computer ships with a partially charged battery. Charge the battery with an EDA61K charging device for a minimum of **5 hours**. Using the computer while charging the battery increases the time required to reach a full charge.



We recommend the use of Honeywell accessories and power adapters. Use of any non-Honeywell accessories or power adapters may cause damage not covered by the warranty.

EDA61K mobile computers are designed for use with the following EDA61K charging accessories: Home Base, Quad charger and USB Cable. For information about accessories, see the ScanPal EDA60K/EDA61K Series Enterprise Mobile computer Accessories Guide” at www.honeywellaidc.com.



Ensure all components are dry prior to mating the computers and batteries with peripheral devices. Mating wet components may cause damage not covered by the warranty.

Turn Power On/Off

The first time you power on the computer, a Welcome screen appears. You can either scan a configuration barcode or use the Wizard to manually set up the computer. Once setup is complete, the Welcome screen no longer appears on startup and Provisioning mode (see page 13) is automatically turned off (disabled).

To turn the computer on:

- Press and hold the **Power** button for approximately 3 seconds, and then release.

To turn the computer off:

1. Press and hold the **Power** button until the options menu appears.
2. Touch **Power off**.

Note: *You should always power off the computer before removing the battery.*

Remove the Battery

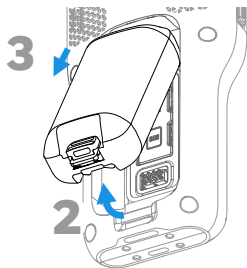
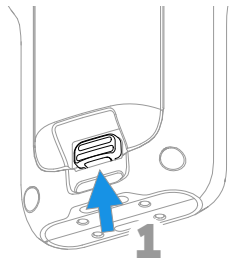

Battery Replacement

Hot Swap

You can replace the battery on demand provided the following conditions are met:

- The computer has been powered on for at least **4 minutes**.
AND
- You insert a new battery within 30 seconds.

Sleep Mode

Sleep mode automatically turns the touch panel display off and locks the computer to save battery power when the computer is inactive for a programmed period of time.

1. Press and release the **Power** button to wake the computer.
2. Drag the  lock icon toward the top of the display to unlock the Mobile.

Adjust the Display Sleep Time

To adjust the amount of time before the display sleeps after inactivity:

1. Swipe up on the Home screen.
2. Select **Settings** > **Display** > **Sleep**.
3. Select the amount of time before the display goes to sleep.
4. Press  to return to the Home screen.



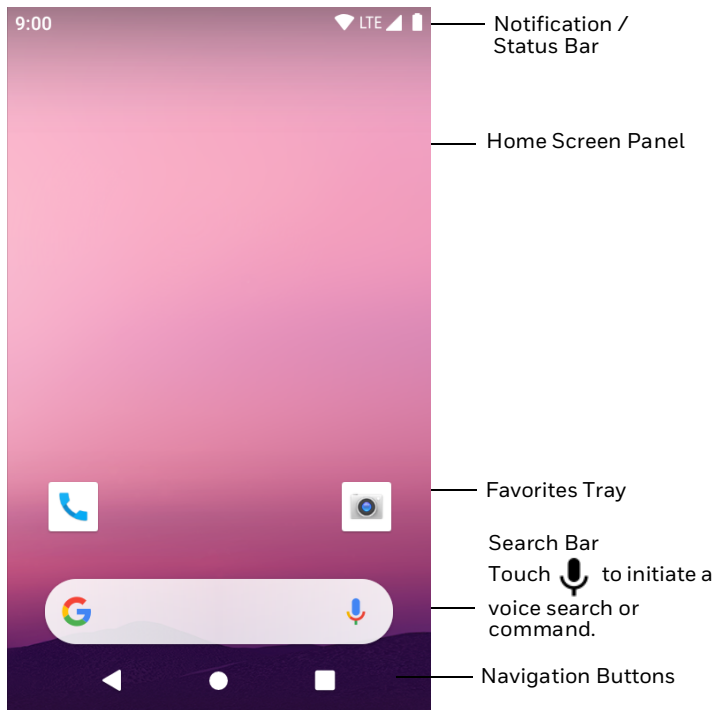

About the Home Screen



To learn how to customize the Home screen, see the user guide.

Navigation and Function Buttons

For button locations, see [Mobile Computer Features](#).

Button	Description	
	Back	Return to the previous screen.
	Home	Return to the Home screen.
	Scan	Press left, right or front scan button to trigger the scanner.
	Recent Apps	View and switch between recently used apps.

About Provisioning Mode

After completing the out-of-box set up process, Provisioning mode is automatically turned off. Scanning a barcode to install applications, certificates, configuration files, and licenses on the computer is restricted unless you enable Provisioning mode in the Settings app. To learn more, see the user guide.

Scan a Barcode with the Scan Demo

For optimum performance, avoid reflections by scanning the barcode at a slight angle.

1. Swipe up on the screen to access all apps.
2. Select **Demos** > **Scan Demo**.
3. Point the computer at the barcode.
4. Touch **Scan** on the screen or press and hold any Scan button. Center the aiming beam over the barcode.

The decode results appear on the screen.

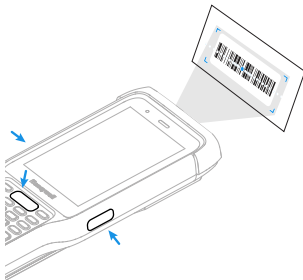

Note: *In the Scan Demo app, not all barcode symbologies are enabled by default. If a barcode does not scan, the correct symbology may not be enabled. To learn how to modify the default app settings, see the user guide.*

Sync Data

To move files between your EDA61K and your computer:

1. Connect the EDA61K to your computer using a USB charge/communication dock or snap on.
2. On the EDA61K, swipe down from the top of the screen to see the notifications panel.
3. Select the Android System notification twice to open the options menu.
4. Select either **File Transfer** or **PTP**.
5. Open the file browser on your computer.
6. Browse to the EDA61K. You can now copy, delete, and move files or folders between your computer and EDA61K as you would with any other storage drive (e.g., cut and paste or drag and drop).

Note: *When Provisioning mode is turned off, some folders are hidden from view in the file browser.*

Restart the Mobile Computer

You may need to restart the mobile computer to correct conditions where an application stops responding to the system or the computer seems to be locked up.

1. Press and hold the **Power** button until the options menu appears.
2. Select **Restart**.

To restart the computer if the touch panel display is unresponsive:

- Press and hold the **Power** button for approximately 8 seconds until the computer restarts.

Note: *To learn about advanced reset options, see the user guide.*

Support

To search our knowledge base for a solution or to log into the Technical Support portal and report a problem, go to www.hsmcontactsupport.com.

Documentation

Product documentation is available at www.honeywellaidc.com.

Limited Warranty

For warranty information, go to www.honeywellaidc.com and click **Resources** > **Product Warranty**.

Patents

For patent information, see www.hsmpats.com.

Disclaimer

Honeywell International Inc. (“HII”) reserves the right to make changes in specifications and other information contained in this document without prior notice, and the reader should in all cases consult HII to determine whether any such changes have been made. The information in this publication does not represent a commitment on the part of HII.

HII shall not be liable for technical or editorial errors or omissions contained herein; nor for incidental or consequential damages resulting from the furnishing, performance, or use of this material. HII disclaims all responsibility for the selection and use of software and/or hardware to achieve intended results.

This document contains proprietary information that is protected by copyright. All rights are reserved. No part of this document may be photocopied, reproduced, or translated into another language without the prior written consent of HII.

Copyright © 2020 Honeywell International Inc. All rights reserved.

Free Manuals Download Website

<http://myh66.com>

<http://usermanuals.us>

<http://www.somanuals.com>

<http://www.4manuals.cc>

<http://www.manual-lib.com>

<http://www.404manual.com>

<http://www.luxmanual.com>

<http://aubethermostatmanual.com>

Golf course search by state

<http://golfingnear.com>

Email search by domain

<http://emailbydomain.com>

Auto manuals search

<http://auto.somanuals.com>

TV manuals search

<http://tv.somanuals.com>