

MAXPRO® NVR PE

(Professional Edition)—Rev B
Enterprise Network Video Recorder

Quick Install Guide

Document 800-15428V4 – Rev A – 08/2016

Introduction

Welcome to your new Honeywell MAXPRO® NVR PE. This guide helps you set up the NVR right out of the box. Before installing your NVR, please read this guide carefully.

Note Translated Quick Install Guides can be accessed on your MAXPRO NVR unit after logging in, by clicking on **Start menu > Honeywell > Quick Install Guides.**

Keyboard Controller (Optional) Follow the documentation that was included with your IP keyboard controller to connect it to the NVR.

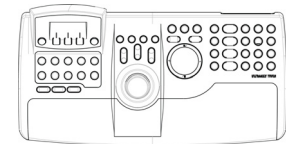

Network Connections Connect a network PoE switch to the camera network port at the rear of the NVR. Connect your cameras to the network PoE switch with CAT5 Ethernet cables. Optionally, connect the client workstation network port to your client workstation network through a network switch. This allows remote access to your NVR. The default client workstation network IP address must be changed to an available static IP address on your client workstation network.

Monitor(s) The MAXPRO NVR PE comes with built-in graphics and four types of monitor outputs. The unit supports connection of a single monitor using one of the outputs. The local monitor can be used to configure the NVR; however continuous local video monitoring is not recommended.

	HDMI Output	Not used
	DVI-D Output	to DVI monitor or to HDMI monitor with the adapter
	VGA Output	to VGA monitor
	Display Output	to DP monitor

The recommended resolution for your monitor is 1280 x 1024 pixels (minimum 1024 x 768) and display colors of at least 32 bit.

Dual Network Configuration

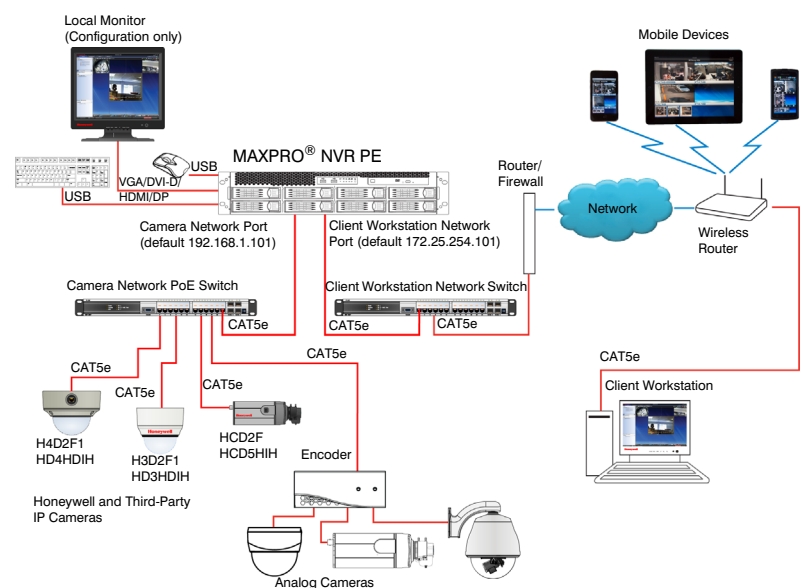

Contact your dealer to purchase Honeywell and third-party IP and analog cameras and encoder.

Power Up the Unit

Note Honeywell recommends using an uninterruptible power supply (UPS) for the MAXPRO NVR PE unit, the camera network switch, and the cameras to ensure that the NVR can continue to record video during a power outage or during transient power events. If you need to monitor video during a power outage, consider a UPS for the monitor as well.

- Before powering up the NVR, turn on camera(s) and other devices connected to the NVR.
- Press the power button on the front of the NVR.

Front Panel LEDs

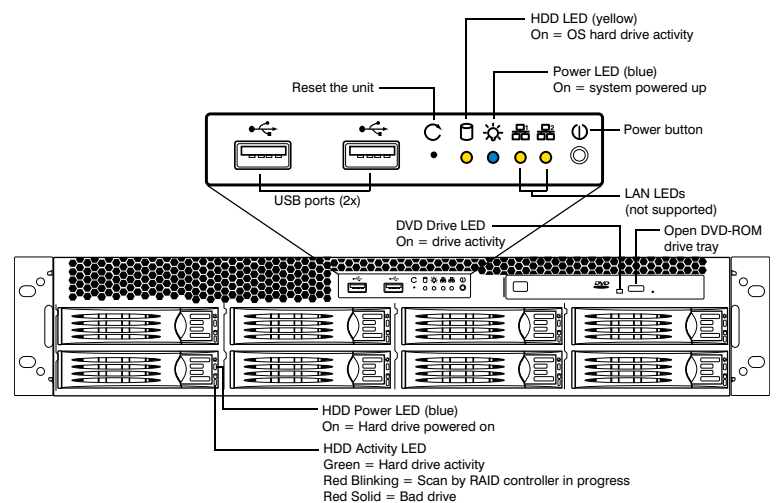

- After powering on the unit, you are prompted to log on. The Default user is user name: **NVR-Admin**, password: **Password\$123**. The user name and password are case sensitive. You will be prompted to create a new password the first time that you log in. The setup wizard starts automatically but may take two minutes to initiate.

Note Translated Quick Install Guides can be accessed on your MAXPRO NVR unit after logging in, by clicking on **Start menu > Honeywell > Quick Install Guides.**

Configure the RAID

- The video storage hard drives are pre-configured for RAID 5 in the factory but can be reconfigured for RAID 6 if required. However, there will be less usable video storage space.
- To access the RAID controller, click the HWAM icon on the desktop and login with:
 - User name = **admin**
 - Password = **0000**

Unpack



Check that the items received match those listed on the order form and packing slip. The packing box should include, in addition to your NVR unit and this guide:

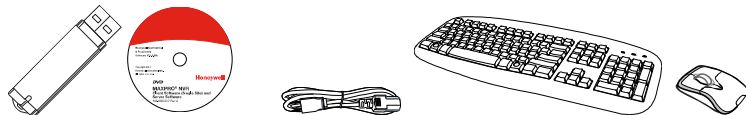

Recovery USB Flash Drive

MAXPRO NVR Client Software (Single Site) and Server Software DVD (includes manuals)

MAXPRO Viewer Multi-Site Viewing Software Kit (includes DVD and Getting Started Guide). Not shown.

Not shown:
DVI to HDMI adapter
MAXPRO NVR DDNS Installation Instructions
Video storage hard drives (installed in the unit)
Rail hardware kit with instructions

Note Other peripheral hardware (owner supplied) will also be needed for your installation (such as cameras, network PoE switch for the camera network, network switch for a client workstation network, a monitor, and an optional keyboard controller).

Install the Hardware

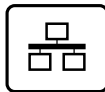

Mount the MAXPRO NVR PE Unit in a Rack

- Remove the bezel (if you ordered this option and it is installed) from the front of the unit by turning the bezel key lock clockwise, and then pulling it away from the unit.
- Mount the NVR with the supplied rail hardware kit. The kit allows the MAXPRO NVR PE unit to slide in and out of the rack it is mounted in and provides rear support for the chassis. Refer to the installation instructions included with the rail hardware kit.
- Replace the bezel (if supplied) on the front of the unit. Insert the right side of the bezel into the tabs on the right handle on the front plate of the unit and then align the bezel key lock with the left handle. Slide the left side of the bezel into place. Turn the bezel key lock counterclockwise to secure the bezel.

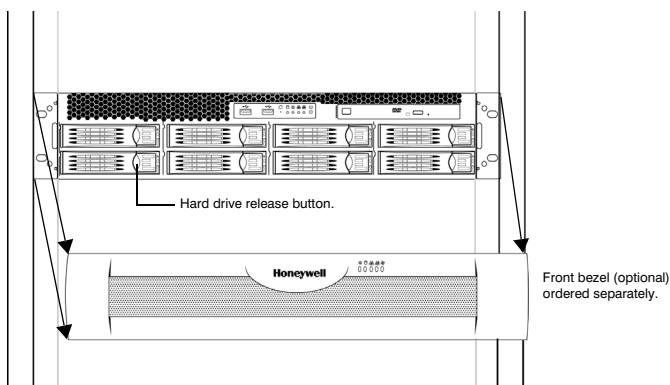

Connect the Hardware

Rear Panel

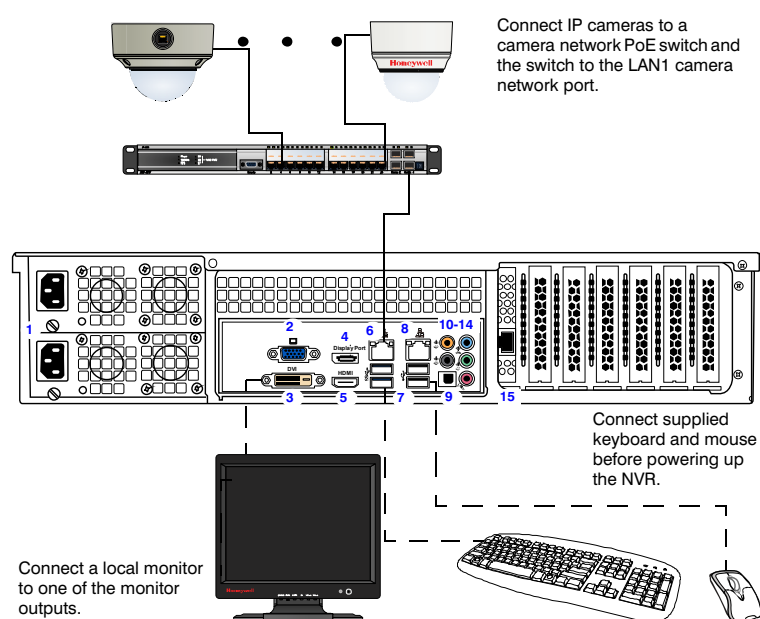

Connect a local monitor to one of the monitor outputs.

#	Connector	Connects to...
1	AC Power (x2)	Electrical outlets
2	VGA Port	VGA monitor
3	DVI-D Port	DVI monitor or HDMI monitor with adapter
4	Display Port	DP monitor
5	HDMI Port	Not used
6	LAN1 - Camera Network Port	Network
7	USB Ports (x4)	Various devices
8	LAN2 - Client Network Port	Network
9	S/PDIF (Optical)	Not used
10-14	Audio Inputs and Outputs	Not used
15	RAID Management Port (plugged)	Not used



Honeywell IP Camera Configuration

Using the MAXPRO NVR Wizard (3 Clicks* to Live Video)

Note The setup wizard starts automatically but may take two minutes to initiate.



Reset values without saving changes. Proceed to CAMERA DISCOVERY.

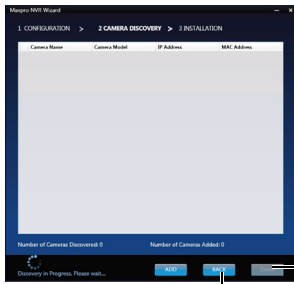

Return to CONFIGURATION page. Click only after all connected cameras are discovered and added.

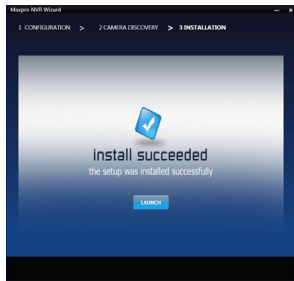

1. The CONFIGURATION dialog appears. When the network is ready (network icon in Windows tray), click **NEXT** to accept the default settings and proceed to CAMERA DISCOVERY. To modify the settings for your unique system requirements, follow the table below. After initial setup, you can do this in the MAXPRO NVR client.

Field	Description
Video Format	NTSC, PAL
Enable Continuous Recording	Start recording as soon as the camera is added in MAXPRO NVR.
Dynamic IP Synchronization	NVR synchronizes any change in a device's IP address.
Auto Add Discovered Cameras	Any newly connected device is automatically added to the Devices list.
Choose Camera Network	Choose your camera network.
Auto IP Assignment	Assigns a valid static IP address to the camera. Use only if you do not have a DHCP server and you want to assign an IP address in your computer network range.
Filter Discovered Cameras	Filter the discovered cameras based on the camera model and/or IP range.

2. The CAMERA DISCOVERY window appears. Each newly connected camera is identified and an IP address is assigned to the camera by the Wizard, after which the camera reboots. It may take a few minutes before cameras are discovered and added. You will see a *Discovery in progress...* indicator as well as a pop-up message on the lower right of your monitor. Click **Done**.

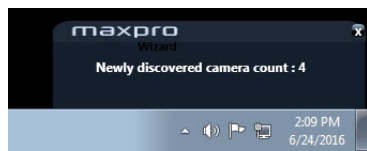

3. The INSTALLATION window appears. Click **LAUNCH** to start the MAXPRO NVR application. Proceed to *Live View*.
4. Only Honeywell IP cameras and HVE encoders (except Honeywell Performance Series and New equiP® Series IP cameras) are discovered and added in the MAXPRO NVR Wizard.

* 3 clicks for specific models with default settings and in a local area network.

Third Party Device Configuration

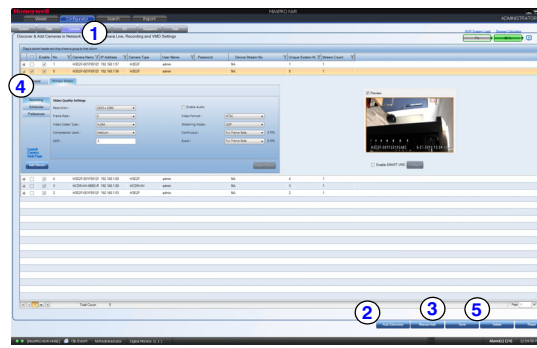

1. On the **Configurator** tab, click the **Camera** tab.
2. Click **Auto Discovery** (Auto Discovery) to automatically discover the connected IP cameras in the subnet.
3. Click **Manual Add** (Manual Add) to manually add the IP device to the Camera list. Enter the device's IP address into the field and ensure that the user name and password listed for the new camera match the user name and password of that camera.
4. To change the default parameters of a camera, select it and then click **⊞** at the beginning of the camera line to open the camera advanced settings pane where you can modify the settings as required.
5. Click **Save** for your new settings to take effect.

Additional Configuration

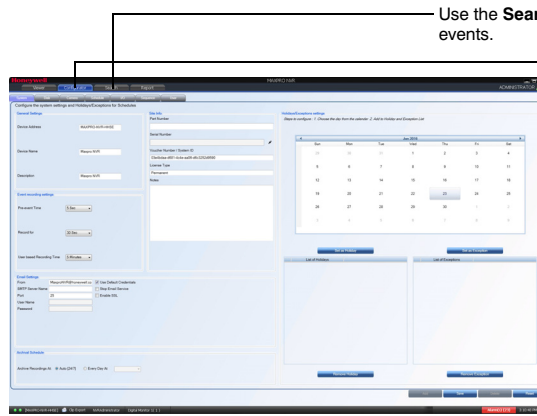

Use the **Search** tab to search for recorded video (clips) or events. Use the **Configurator** tab to configure video devices and set up your MAXPRO NVR system.

Configurator tab sub-tabs:

- System:** System information, event recording, email, archival schedule, holiday/exceptions for schedules.
- Disk:** Configure and monitor video storage hard drives.
- Camera:** Discover and add network cameras, live camera configuration, recording, video motion detection.
- Schedule:** Set recording schedules configuration.
- I/O:** Configure input and output for each camera.
- Sequence:** Select a sequence of cameras for live video.
- User:** Set user access and permission levels.



MAXPRO NVR Web Client

To access the Web Client, click on the MAXPRO NVR Web Client shortcut on the NVR desktop. Click **Continue** on the self signed certificate warning message that appears. Login to the Web Client with default Username: **admin** and Password: **trinity**.



MAXPRO NVR PE Default IP Address Configuration

You can configure your MAXPRO NVR unit with two network ports with the following static IP addresses:

- **192.168.1.101** for LAN1 (Camera Network)
- **172.25.254.101** for LAN2 (Client Workstation Network)

If more than one MAXPRO NVR unit is on the same network, you must assign a unique IP address and computer name to each unit (the default name is **MAXPRO-NVR**).

To change the IP address:

1. Click the **network icon** () or () located next to the clock (lower right of the screen), click **Open Network and Sharing Center**, then click **Change adapter settings**.
2. Right-click **Camera Network** or **Client Workstation Network**, and then click **Properties**.
3. Click **Internet Protocol Version 4 (TCP/IPv4)**, then click **Properties**.
4. Click **Use the following IP address**, and type the IP address settings in the **IP address**, **Subnet mask**, and **Default gateway** boxes.
5. Click **Use the following DNS server addresses**, and then, in the **Preferred DNS server** and **Alternate DNS server** boxes, type the addresses of the primary and secondary DNS servers. This step is required when clients connect through the Internet.

To change the computer name:

1. Click **Start**, right-click **Computer**, click **Properties**, click **Advanced system settings**, click the **Computer Name** tab, and then click **Change**.
2. Under **Computer name**, delete the old computer name, type a new computer name, and then click **OK**. The name cannot contain spaces or all numbers or any of the following characters: < > ; : " * + = \ | ? . Restart the computer after changing the computer name.
3. Navigate to the C:\Program Files (x86)\Honeywell\MaxproNVR\TrinityFramework\bin folder, and then double-click **MaxproNVRMachineNameUtility.exe** to open the MAXPRO NVR Utility.
4. The new computer name should automatically appear in the **Machine Name** field. If it does not, enter the name manually. Click **Update**. The message **Machine Name Updated successfully** appears when the update is complete.



More Information

MAXPRO NVR PE

Third Party Devices

Please refer to the appropriate user guide located on the software/documentation DVD or on the Honeywell product web site at www.honeywell.com/security.

A comprehensive list of all the third party devices supported by MAXPRO NVR PE is available on the product compatibility page: www.security.honeywell.com/hota/compatibility/index.html.



The *MAXPRO NVR Guides (Installation and Configuration Guide, and Operator's Guide)* provide detailed information on adding and configuring third party cameras, the multi-function Web Client, as well as other advanced features.



Live View

1. Please wait while the system logs you on automatically as a Windows Logged-In User.
2. MAXPRO NVR launches and the Viewer tab displays (see below).
3. To view video from cameras, drag **MAXPRO NVR** in the Devices list into the display panel to show video from all discovered cameras in the Viewer. You can also highlight and drag each camera into a panel.

Note For continuous monitoring of live video, it is recommended that you use a remote client workstation. To install a remote client, use the installation software on the software DVD included with your NVR. Select **Client Installation** as the Installation Type during setup.

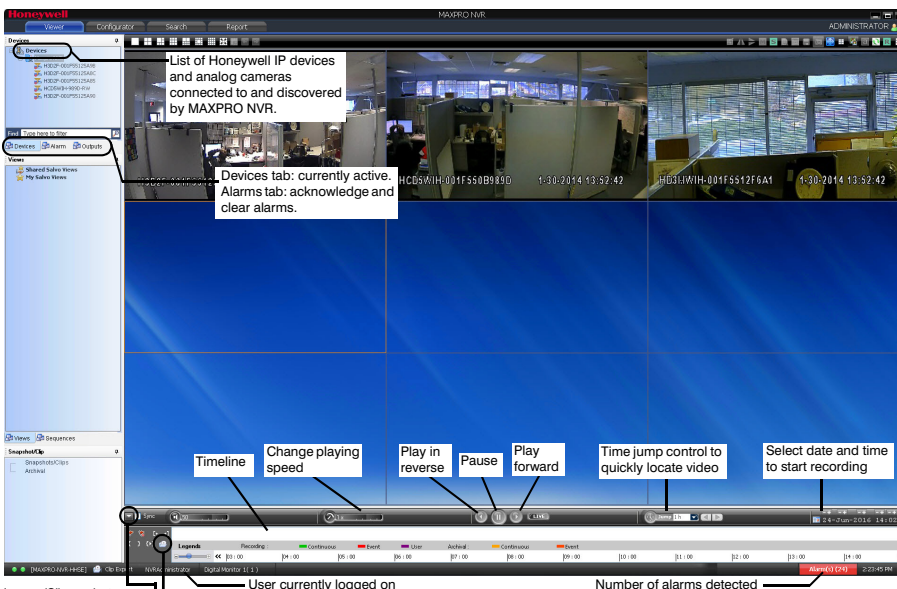
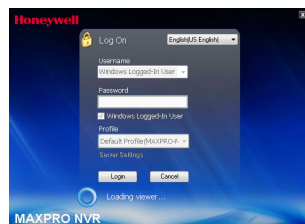

Images/Clips: select images and clips to view. Double-click or drag the clip to a Viewer panel to view. To export a clip for forensics, click the arrow to switch to Full Timeline mode, then click the **Clip Export** icon.

User currently logged on

Number of alarms detected



Free Manuals Download Website

<http://myh66.com>

<http://usermanuals.us>

<http://www.somanuals.com>

<http://www.4manuals.cc>

<http://www.manual-lib.com>

<http://www.404manual.com>

<http://www.luxmanual.com>

<http://aubethermostatmanual.com>

Golf course search by state

<http://golfingnear.com>

Email search by domain

<http://emailbydomain.com>

Auto manuals search

<http://auto.somanuals.com>

TV manuals search

<http://tv.somanuals.com>