

## Marathon

---

### Hand-Held Computer

With Microsoft Windows® 7 Professional or

Microsoft Windows® Embedded Standard 2009 or

Microsoft Windows® XP® Professional Operating System

## Quick Start Guide



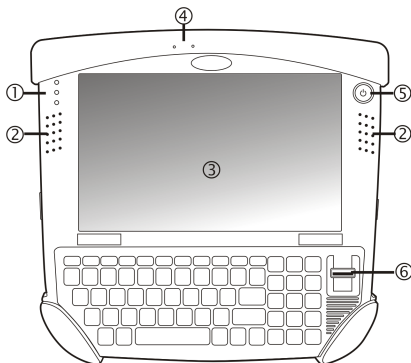

## Marathon - Front



- 1 Status Indicators
- 2 Speakers
- 3 Touchscreen / Display
- 4 Microphone
- 5 Power Button
- 6 Biometric Mouse

### Status Indicators

	Drive Status
	Wireless Status
	Battery Status



**Swipe Biometric Mouse**

## Marathon - Back

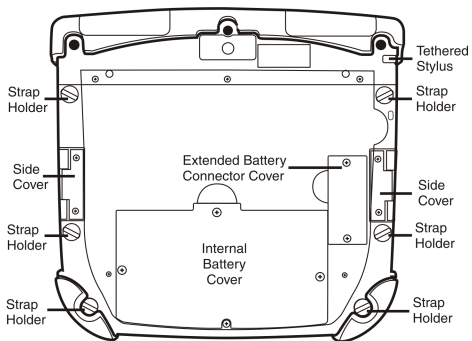

## Marathon - Bottom

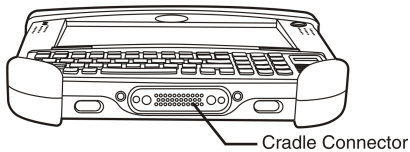

## Marathon - Left

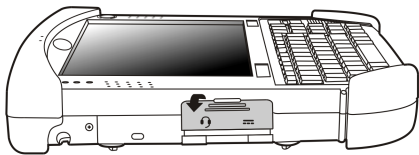

Connect Power  
and Headset

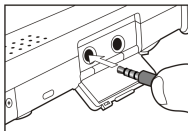

Audio Connection

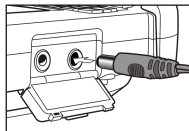

AC Power Connection

## Marathon - Right

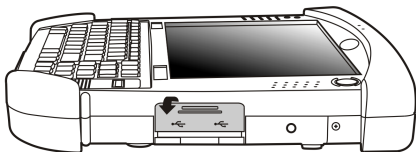

Connect USB Cable

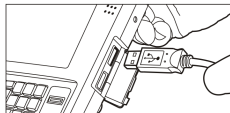

USB Connection

## Hand Strap Assembly

### Strap Components

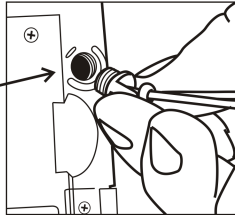
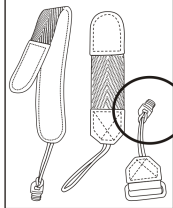

### Hand Strap Holders

1. Remove plug on the back of the device.
2. Replace plug on the device with the plug on the end of the strap.

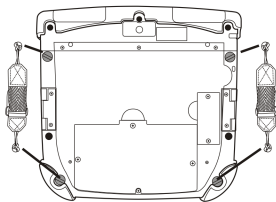
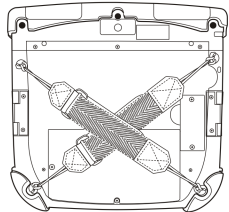
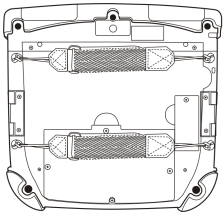

## Shoulder Strap Assembly

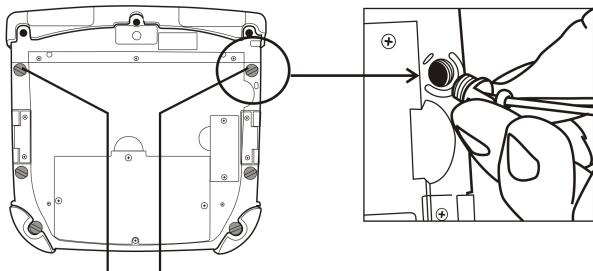

### Shoulder Strap Holders

1. Remove plug on the back of the device.
2. Replace plug on the device with the plug on the end of the strap.

### Strap Components

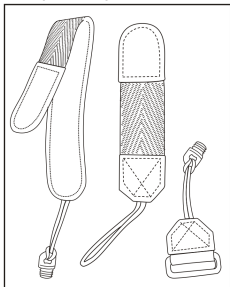

## Battery Charger - Extended Battery

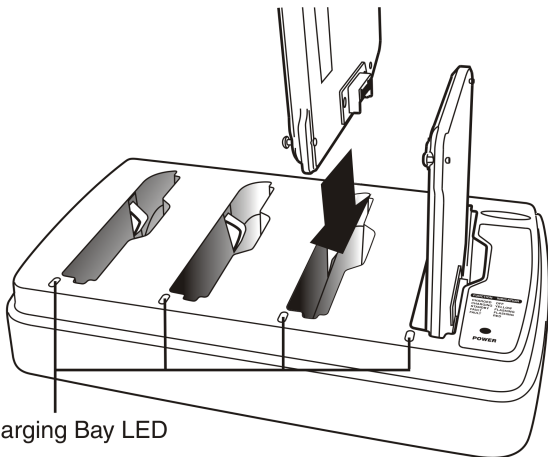

Charging Bay LED

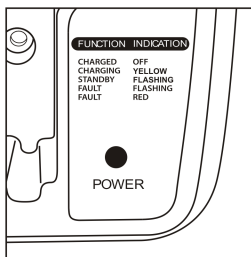

Power Indicator and LED Legend

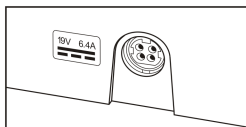

Power Connector (Back)

# Marathon Desktop Dock

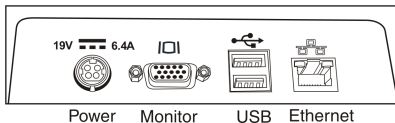
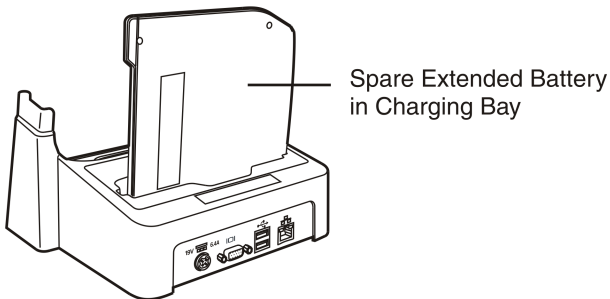
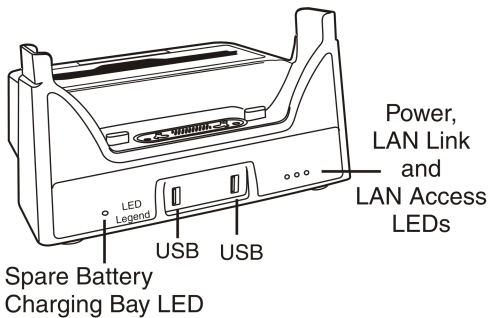



## Vehicle Dock - Front

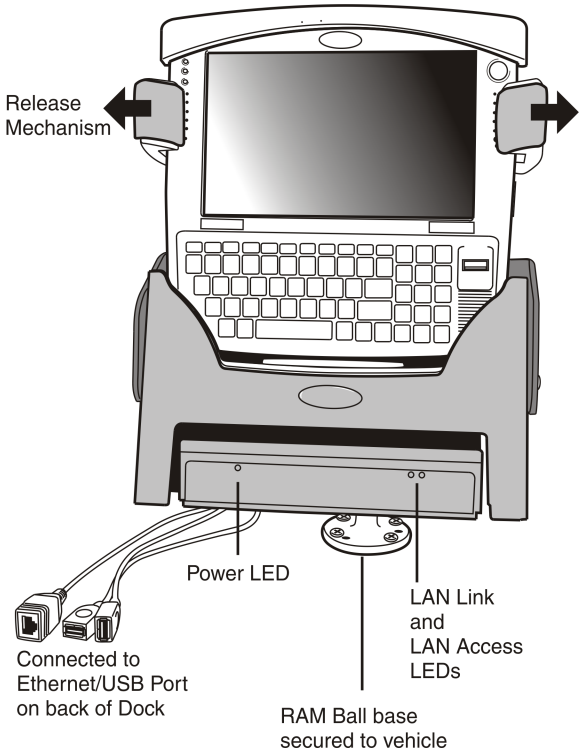

## Vehicle Dock - Mounting

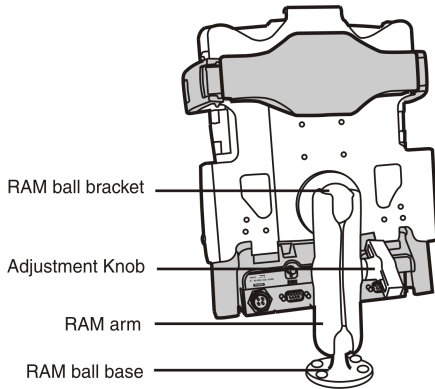

## Vehicle Dock - Back

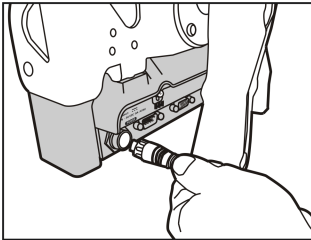

Connect Power from  
Vehicle Battery

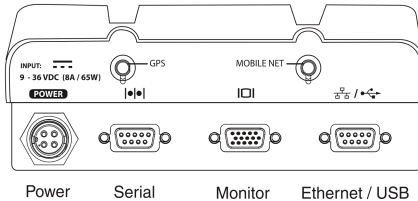

## Install SIM Card

1. Remove SIM Card Cover

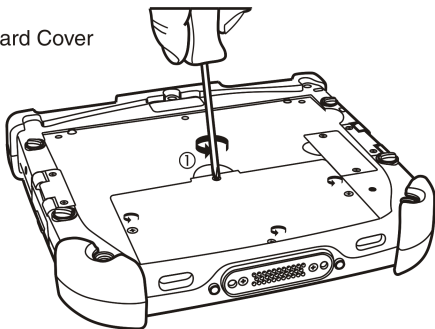

2. Lift the battery using the pull strap and move it aside. Do not disconnect the battery.

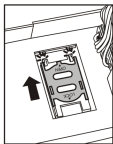

3. Push the SIM card holder up (OPEN) to release the lock. Do not remove the SIM card holder.



4. Carefully lift the SIM card holder up.
5. Slide a SIM card into the slot.
6. Slide the SIM card holder down (LOCK).
7. Replace the battery in the battery well.
8. Replace the battery cover.

## Attach Extended Battery

1. Remove Extended Battery Connector Cover

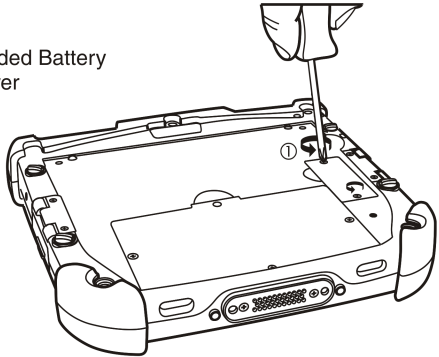

2. Line up the charging pins on the extended battery with the charging pins in the extended battery connector bay.
3. Connect the extended battery using the captive screws in the extended battery.

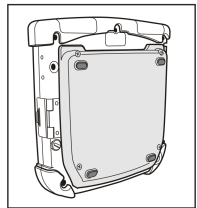
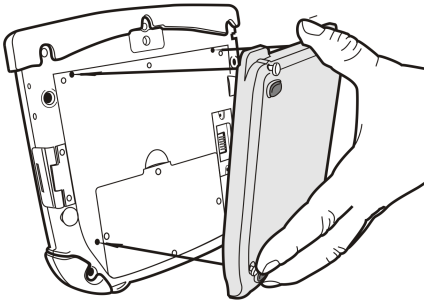

Battery Connected

## Setting up the Marathon

Please have the following Information available before setting up your Marathon:

- Network ID (SSID) of the Access Point
  - WEP key or LEAP authentication credentials
1. Install the hand strap and/or shoulder strap.
  2. Connect the Marathon power cable.
  3. Press the Power button.
  4. Accept the Windows Licensing Agreement.
  5. Set the date and time.
  6. Set power management.
  7. Adjust speaker volume.
  8. Edit the radio parameters.
  9. Restart the Marathon.

## Bluetooth and the Marathon

Please refer to the Marathon Reference Guide for information when using the Marathon with Bluetooth.

## WWAN and the Marathon

Please refer to the Marathon Reference Guide for information when using WWAN. Use of WWAN in the US and Canada requires a hip pad or a 62Whr extended battery. Removing the hip pad or extended battery will disable the WWAN radio in the US and Canada.

## Setting Up the Radio

If the access point uses an authentication protocol (WEP, LEAP, etc.), your radio must use the same authentication. Please contact your IT department for WEP keys or LEAP credentials. Please refer to the Marathon Reference Guide for information on using WPA.

1. Tap **Start > Programs > Summit > SCU** OR tap the Summit Client Utility icon on the desktop.
2. Tap the **Admin Login** button and enter the password (default = SUMMIT).
3. Tap the **Profile** tab and make sure the Default profile is selected.
4. Select **SSID** and enter your SSID value.
5. If the access point is using WEP, select **WEP** from the Encryption pull down list.
6. Tap the **WEP keys/PSKs** button and enter the WEP Key(s) and tap **OK**. Skip to step 12.
7. If the access point is using LEAP, select **LEAP** from the EAP Type pull down list.
8. Select **WEP EAP** from the Encryption pull down list.
9. If the Cisco/CCS certified AP is configured for open authentication, set the **Auth Type** radio parameter to **Open**.
10. If the AP is configured for network EAP only, set the **Auth Type** radio parameter to **LEAP**.
11. Tap the **Credentials** button and enter the User Name and Password.
12. Tap the **Commit** button to save the radio configuration.
13. Tap the **Main** tab. Wait for a radio connected message.
14. Tap the **Admin Logout** button when finished.
15. Restart the Marathon.

Please refer to the Radio Mode parameter in the Marathon Reference Guide. It is important that this parameter setting corresponds to the Access Point to which the Marathon connects.

## **Disclaimer**

Honeywell International Inc. ("HII") reserves the right to make changes in specifications and other information contained in this document without prior notice, and the reader should in all cases consult HII to determine whether any such changes have been made. The information in this publication does not represent a commitment on the part of HII.

HII shall not be liable for technical or editorial errors or omissions contained herein; nor for incidental or consequential damages resulting from the furnishing, performance, or use of this material.

This document contains proprietary information that is protected by copyright. All rights are reserved.

© 2011-2012 Honeywell International Inc. All rights reserved.

Other product names or marks mentioned in this document may be trademarks or registered trademarks of other companies and are the property of their respective owners.

Web Address: [www.honeywellaidc.com](http://www.honeywellaidc.com)

## **Patents**

For patent information, please refer to [www.honeywellaidc.com/patents](http://www.honeywellaidc.com/patents).

## **Technical Assistance**

Contact information for technical support, product service, and repair can be found at [www.honeywellaidc.com](http://www.honeywellaidc.com).

## **Limited Warranty**

Refer to [www.honeywellaidc.com/warranty\\_information](http://www.honeywellaidc.com/warranty_information) for your product's warranty information.

## **User Documentation**

To download the Marathon user documentation go to [www.honeywellaidc.com](http://www.honeywellaidc.com).



## Free Manuals Download Website

<http://myh66.com>

<http://usermanuals.us>

<http://www.somanuals.com>

<http://www.4manuals.cc>

<http://www.manual-lib.com>

<http://www.404manual.com>

<http://www.luxmanual.com>

<http://aubethermostatmanual.com>

Golf course search by state

<http://golfingnear.com>

Email search by domain

<http://emailbydomain.com>

Auto manuals search

<http://auto.somanuals.com>

TV manuals search

<http://tv.somanuals.com>