

# PB22 | PB32

Mobile Label and Receipt Printer



**User Guide**

Intermec by Honeywell  
16201 25th Ave W  
Lynnwood, WA 98087

The information contained herein is provided solely for the purpose of allowing customers to operate and service Intermec-manufactured equipment and is not to be released, reproduced, or used for any other purpose without written permission of Intermec Inc.

Information and specifications contained in this document are subject to change without prior notice and do not represent a commitment on the part of Intermec Inc.

Copyright © 2009–2016 Intermec, Inc., Honeywell International Inc. All rights reserved.

For patent information, see [www.hsmpats.com](http://www.hsmpats.com).

Microsoft, Windows, and the Windows logo are registered trademarks of Microsoft Corporation in the United States and/or other countries.

Bluetooth is a trademark of Bluetooth SIG, Inc., U.S.A.

Wi-Fi is a registered certification mark of the Wi-Fi Alliance.

## Document Change Record

This page records changes to this document. The document was originally released as Revision 001.

| Version Number | Date    | Description of Change   |
|----------------|---------|---|
| 006            | 3/2016  | Updated the printer voltage specification.<br>Included information to support the new radio: <ul style="list-style-type: none"><li>• Added the topic “Determining Which Radio Is Installed in Your Printer” and removed all specific procedures for configuring security.</li><li>• Added the topic, “Differences in Wireless Communications Settings.”</li></ul> |
| 005            | 4/2013  | Updated the procedure to set up Bluetooth communications. Added information about the AC18 charger to the troubleshooting table.<br>Updated media specifications in Appendix A.<br>Added the cleaning pen to the list of accessories.   |
| 004            | 5/2011  | Revised battery information. Added procedures for configuring the wireless network with PrintSet.   |
| 003            | 2/2011  | Revised to include correct information on how to load media and how to load media for self-strip printing.  |
| 002            | 12/2010 | Revised to add information for upgrading the firmware.  |



# Contents

|                                  |    |
|----------------------------------|----|
| Before You Begin.....            | ix |
| Safety Information.....          | ix |
| Product Identification.....      | ix |
| Contact Customer Support.....    | ix |
| Warranty Information.....        | x  |
| Product Service and Repair.....  | x  |
| Send Feedback.....               | x  |
| Who Should Read This Manual..... | x  |

## **1 Using the PB22 and PB32 Mobile Label and Receipt Printer..... 1**

|  |    |
|--|----|
| Introducing the PB22 and PB32 Mobile Label and Receipt Printers..... | 2  |
| What's New.....  | 2  |
| Identifying the Parts of the Printer.....                            | 3  |
| Understanding the Control Panel.....                                 | 4  |
| Understanding the Printer Language.....                              | 6  |
| Changing the Printer Language.....                                   | 7  |
| Understanding the Printer Sounds.....                                | 10 |
| Understanding the Backlight.....                                     | 10 |
| Using the Batteries.....   | 11 |
| Installing the Battery.....  | 12 |
| Charging the Batteries.....  | 13 |
| Understanding the Battery Icons.....                                 | 13 |
| Extending Battery Life.....  | 14 |
| Loading Media.....   | 15 |
| Printing on Floodcoated Media.....                                   | 19 |
| Understanding the Display Modes.....                                 | 20 |
| Understanding Ready Mode.....  | 20 |
| Understanding Information Mode.....                                  | 20 |
| Understanding Pause Mode.....  | 21 |
| Understanding Setup Mode.....  | 21 |
| Understanding Error Mode.....  | 23 |
| Understanding Test Mode.....   | 23 |
| Using Test Mode.....   | 23 |
| Using Extended Test Mode.....  | 24 |
| Changing Configuration Settings from the Display.....                | 25 |
| Printing a Test Page.....  | 27 |

## **2 Configuring the PB22 and PB32** ..... 29

|  |    |
|--|----|
| Connecting the Printer to Your PC .....                              | 30 |
| Connecting the Printer Through the USB Interface .....               | 30 |
| Connecting the Printer Through the Serial Port .....                 | 31 |
| Connecting the Printer to Your Network .....                         | 33 |
| Setting Up Bluetooth Communications .....                            | 33 |
| Setting Up 802.11 Radio Communications .....                         | 35 |
| Determining Which Radio Is Installed in Your Printer .....           | 35 |
| Setting Up the Printer for Wireless Communications Using PrintSet .. | 36 |
| Configuring the Printer Settings .....                               | 36 |
| Changing Configuration Settings From PrintSet .....                  | 37 |
| Changing Configuration Settings Using the Command Line .....         | 37 |
| Changing Configuration Settings from the Printer Home Page .....     | 37 |
| Changing Configuration Settings Using SmartSystems .....             | 38 |
| Upgrading the Firmware .....   | 38 |
| Upgrading the Printer Firmware Using PrintSet .....                  | 40 |
| Upgrading the Printer Firmware Using the Printer Home Page .....     | 41 |
| Upgrading Printer Firmware Using SmartSystems .....                  | 43 |
| Upgrading the Printer Firmware Using a Communications Program .....  | 43 |
| Downloading Fonts and Graphics .....                                 | 47 |

## **3 Troubleshooting and Maintaining the PB22 and PB32** ..... 49

|  |    |
|--|----|
| Troubleshooting the Printer .....                            | 50 |
| Contacting Product Support .....                             | 50 |
| Understanding Error Messages .....                           | 50 |
| Troubleshooting Printer Problems and Finding Solutions ..... | 52 |
| Troubleshooting Communication Problems .....                 | 54 |
| Using the Line Analyzer in Fingerprint .....                 | 54 |
| Using Dump Mode in IPL .....                                 | 55 |
| Resetting the Printer .....                                  | 56 |
| Cleaning the Printer .....                                   | 56 |
| Cleaning the Printhead .....                                 | 57 |
| Cleaning the Platen Roller .....                             | 58 |
| Cleaning the Printer Exterior .....                          | 58 |
| Cleaning the Printer Media Compartment .....                 | 59 |

|   |    |
|---|----|
| <b>A Specifications</b> .....                         | 61 |
| Specifications .....                                  | 62 |
| Interfaces .....                                      | 66 |
| RS-232 Serial Interface .....                         | 66 |
| USB Interface .....                                   | 67 |
| Differences in Wireless Communications Settings ..... | 68 |
| Accessories .....                                     | 71 |
| <b>B Default Settings</b> .....                       | 73 |
| Factory Default Settings (Fingerprint Printers) ..... | 74 |
| Factory Default Settings (IPL Printers) .....         | 75 |
| Factory Default Settings (ESC/P Printers) .....       | 77 |
| <b>C IPL and Fingerprint Setup Menus</b> .....        | 79 |
| IPL Setup Menu .....                                  | 80 |
| Fingerprint Setup Menu .....                          | 81 |
| <b>I Index</b> .....                                  | 83 |

**Contents**



# Before You Begin

This section provides you with safety information, technical support information, and sources for additional product information.

## Safety Information

Your safety is extremely important. Read and follow all warnings and cautions in this document before handling and operating Intermec equipment. You can be seriously injured, and equipment and data can be damaged if you do not follow the safety warnings and cautions.

This section explains how to identify and understand warnings, cautions, and notes that are in this document.



**A warning alerts you of an operating procedure, practice, condition, or statement that must be strictly observed to avoid death or serious injury to the persons working on the equipment.**



**A caution alerts you to an operating procedure, practice, condition, or statement that must be strictly observed to prevent equipment damage or destruction, or corruption or loss of data.**



**Note:** Notes either provide extra information about a topic or contain special instructions for handling a particular condition or set of circumstances.

## Product Identification

The machine labels are attached to the underside of the printer and contain information on type, model, serial number, and AC voltage. This document provides warnings regarding personal safety during operation of the printer.

## Contact Customer Support

To search our knowledge base for a solution or to log in to the Technical Support portal and report a problem, go to [www.hsmcontactsupport.com](http://www.hsmcontactsupport.com).

## ***Before You Begin***

For our latest contact information, see [www.honeywellaidc.com/locations](http://www.honeywellaidc.com/locations).

### **Warranty Information**

To understand the warranty for your Honeywell product, visit the Honeywell website at [www.honeywellaidc.com](http://www.honeywellaidc.com) and click **Resources > Warranty**.

### **Product Service and Repair**

Honeywell International Inc. provides service for all of its products through service centers throughout the world. To find your service center, go to [www.honeywellaidc.com](http://www.honeywellaidc.com) and select **Support > Contact Support > Service and Repair**. Contact your service center to obtain a Return Material Authorization number (RMA #) before you return the product.

To obtain warranty or non-warranty service, return your product to Honeywell (postage paid) with a copy of the dated purchase record.

### **Send Feedback**

Your feedback is crucial to the continual improvement of our documentation. To provide feedback about this manual, please contact the Technical Communications department directly at [ACSHSMTechnicalCommunications@honeywell.com](mailto:ACSHSMTechnicalCommunications@honeywell.com).

## **Who Should Read This Manual**

This user guide is for the person who is responsible for installing, configuring, and maintaining the PB22 and PB32 printers.

This guide provides you with information about the features of the PB22 and PB32, and how to install, configure, operate, maintain, and troubleshoot them.

# 1

## Using the PB22 and PB32 Mobile Label and Receipt Printer

Use this chapter to familiarize yourself with the PB22 and PB32 mobile label and receipt printer. This chapter contains these sections:

- **Introducing the PB22 and PB32 Mobile Label and Receipt Printers**
- **Using the Batteries**
- **Loading Media**
- **Printing on Floodcoated Media**
- **Understanding the Display Modes**
- **Printing a Test Page**

# Introducing the PB22 and PB32 Mobile Label and Receipt Printers

The PB22 and PB32 are rugged mobile label and receipt printers that are designed for use with Intermec mobile computers, Intermec vehicle mount computers, and the SF51 and SR61 scanners. The PB22 uses 50.8 mm (2 in) media and the PB32 uses 76.2 mm (3 in) media.

The PB22 and PB32 provide:

- a print resolution of 203 dpi.
- print speeds of up to 101.6 mm per second (4 ips).
- 802.11 b/g or Bluetooth radio options.



**Note:** Unless otherwise noted, this manual uses the term “printer” to refer to both the PB22 and PB32 printers.

## What’s New

The is version of the user guide includes these changes:

- Added the topic “**Determining Which Radio Is Installed in Your Printer**” on page 35 and removed all specific procedures for configuring security.
- Added the topic, “**Differences in Wireless Communications Settings**” on page 68.

## Identifying the Parts of the Printer

Use this illustration to familiarize yourself with some of the features of the printer.

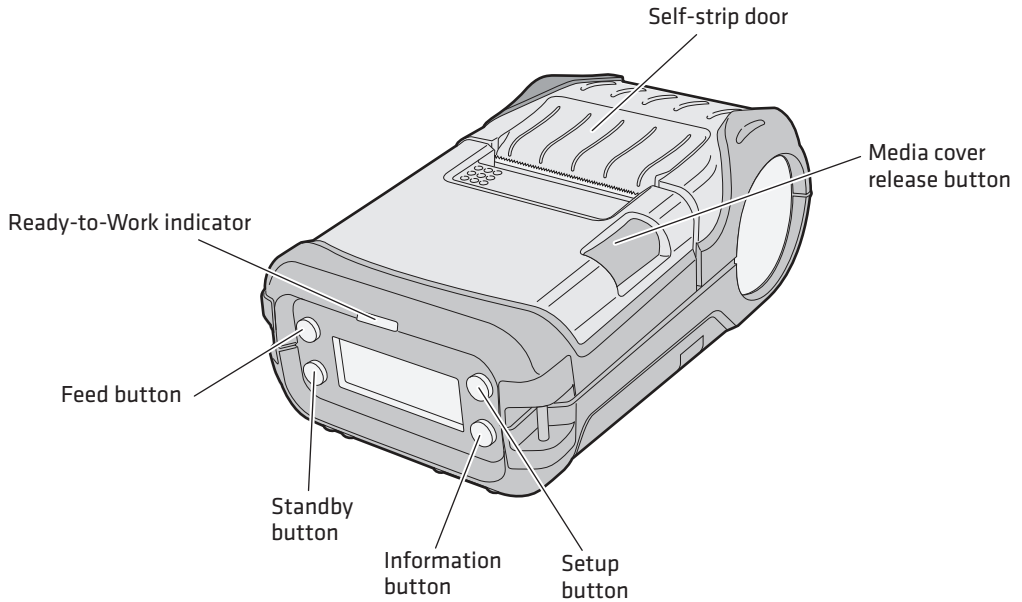

**PB22 and PB32 :** This illustration shows the important features of the printer. A weather-resistant flap protects the communications ports and the external power connector.

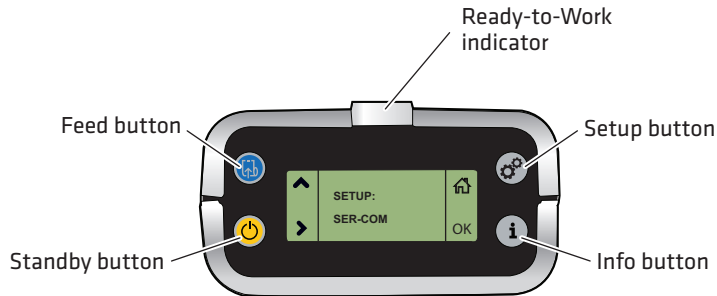

## Understanding the Control Panel

The printer control panel contains four buttons, a liquid crystal display (LCD), and one LED indicator. Use the four buttons to navigate the menu system and perform functions on the printer.



### Printer Control Panel

#### How to Use the PB22 and PB32 Buttons











| Name            | Button  | Function   |
|-----------------|---|--|
| Feed            |    | Press to advance the media. The amount of media that feeds is dependent on the type of media you are using. It will advance by 5 mm (0.2 inch), or feed a configured length of media based on your media and settings.<br>If the printer is printing, pressing this button causes the printer to pause. Press the button again to resume printing. |
| Setup           |  | Press to display the Setup menu. With ESC/P firmware, press and hold to cancel printing.   |
| Standby (Power) |  | Press to put the printer in Standby mode. In Standby mode, power to the radio, the display, and the backlight are turned off.<br>Press to turn the printer back on and put in Ready mode.  |

**How to Use the PB22 and PB32 Buttons (continued)**

| Name | Button  | Function   |
|------|---|--|
| Info |  | <p>Press to display a summary of network connection information and error conditions. Each setting in the summary information displays on the screen for five seconds.</p> <p>In Fingerprint and IPL, press this button in Pause mode to cancel the print job. The info button is not functional with ESC/P.</p> |

All of the buttons can act as “soft keys,” which means that the function of each button depends on the state of the printer. A small icon appears in the screen next to the button to indicate the function it performs.

**Understanding the Soft Keys**

| Button  | Soft Keys   | Description   |
|---|---|---|
|    |    | <ul style="list-style-type: none"> <li>Moves up one level in the menu system. This soft key appears in Setup mode.</li> </ul>                                       |
|   |    | <ul style="list-style-type: none"> <li>Increases the value of a number when editing settings such as an IP address. This soft key appears in Setup mode.</li> </ul> |
|   |    | <ul style="list-style-type: none"> <li>Pauses the printing job. This icon appears only when you are printing.</li> </ul>  |
|   |   | Exit Setup mode and return to Ready mode.   |
|   |  |    |
|  | OK  | <ul style="list-style-type: none"> <li>Moves down one level in the menu system and saves changes to a setting.</li> </ul>   |
|   |  | <ul style="list-style-type: none"> <li>Exits a printing job or exits Information mode.</li> </ul>   |

There is only one LED on the printer: the Ready-to-Work™ indicator.

**Understanding the Ready-to-Work Indicator**

| Indicator State | Description  |
|-----------------|--|
| Off             | One of several conditions: <ul style="list-style-type: none"><li>• The printer is in Standby mode.</li><li>• The printer is in Info mode.</li><li>• The printer is in Setup mode.</li></ul>  |
| On              | The printer is turned on and operating.  |
| Blinking        | One of several conditions: <ul style="list-style-type: none"><li>• The printer is out of paper.</li><li>• The media cover is open.</li><li>• There is a printer error that requires you to perform an action. For a list of possible problems, see <a href="#">“Troubleshooting the Printer” on page 50.</a></li></ul> |

**Understanding the Printer Language**

Your printer comes with Intermec Printer Language (IPL), Fingerprint, ESC/P, ZSim, and the ability to run any of the printer languages. The language you select affects the functionality of the printer and how you interact with it.

The printer displays the current firmware type and version in Ready mode.

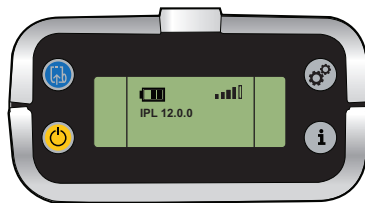

**Printer Running IPL Firmware**

The first time you turn on the printer, you select the printer language to run on the printer. The language you select automatically runs each time you turn on your printer.



**To select the printer language**

- 1 Turn on the printer.
- 2 Press the appropriate button to select a language.

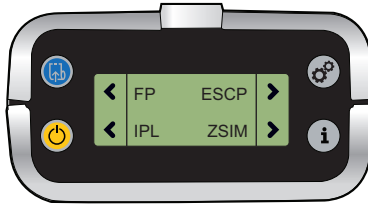

## **Changing the Printer Language**

The printer language you select affects the functionality of the printer and how you interact with it. You can change the printer language using PrintSet, the printer home page, a communications program like HyperTerminal, or the printer display.

**To change the printer language using PrintSet**

- 1 Connect your printer to your PC using a serial cable. For help, see **“Connecting the Printer Through the Serial Port” on page 31.**
- 2 Open PrintSet. The Intermec PrintSet dialog box appears.
- 3 Under My Printers, click the printer you want to work with.
- 4 Click **Printer > Language Wizard**. The Language Wizard appears.
- 5 Follow the prompts to change the printer language.

**To change the printer language using Fingerprint and a communications program**

- 1 Connect your printer to your PC using a serial cable. For help, see **“Connecting the Printer Through the Serial Port” on page 31.**
- 2 Start a communications program like HyperTerminal.
- 3 Send the enable administrator rights command:  

```
run "su -p pass admin"
```
- 4 Send the run command to change the printer language:  

```
setlanguage IPL -r
```

**To change the printer language using IPL and a communications program**

- 1 Connect your printer to your PC using a serial cable. For help, see **“Connecting the Printer Through the Serial Port” on page 31.**
- 2 Start a communications program like HyperTerminal.
- 3 Send the enable administrator rights command:  
`<STX><ESC>.y, su -p pass admin <ETX>`
- 4 Send the run command to change the printer language:  
`<STX><EXC> .y, setlanguage FP -r<ETX>`

**To change the printer language using ESC/P and a communications program**

- 1 Connect your printer to your PC using a serial cable. For help, see **“Connecting the Printer Through the Serial Port” on page 31.**
- 2 Start a communications program like HyperTerminal.
- 3 Enter U-shell. Press the ESC key and type:  
`{SYS:USH}`
- 4 Send the enable administrator rights command:  
`su -p pass admin`
- 5 Send the run command to change the printer language:  
`setlanguage IPL -r`

**To change the printer language using the display and Fingerprint**

- 1 Press the **Setup button**. The Setup menu system appears.
- 2 Press **➤** until you reach **Print Defs**.
- 3 Press **OK** to enter the Print Defs menu system.
- 4 Press **➤** until you reach **CMD Language**.
- 5 Press **OK** to enter the CMD Language menu system.
- 6 Press **➤** until you see the language of you want to select.
- 7 Press **OK** to select the printer language.

- 8** Cold boot the printer:
  - a** Remove the printer battery.
  - b** Replace the printer battery.
  - c** Turn the printer on.

**To change the printer language using the display and IPL**

- 1** Press the **Setup** button. The Setup menu system appears.
- 2** Press **▶** until you reach **Test/Service**.
- 3** Press **OK** to enter the Test/Service menu system.
- 4** Press **▶** until you reach **CMD Language**.
- 5** Press **OK** to enter the CMD Language menu system.
- 6** Press **▶** until you see the language you want to select.
- 7** Press **OK** to select the language.
- 8** Cold boot the printer:
  - a** Remove the printer battery.
  - b** Replace the printer battery.
  - c** Turn the printer on.

**To change the printer language using the display and ESC/P**

- 1** Make sure the printer is in Ready mode.
- 2** Turn the printer off.
- 3** Open the media door.
- 4** Press and hold the **Feed** and **Power** buttons until the display shows “Close Printer Door.”
- 5** Press **▶** until you reach **CMD Language**.
- 6** Press **OK**.
- 7** Press and hold the **Power** button until the different command languages scroll automatically.
- 8** Press **OK** to select the printer language. The printer reboots.

## Understanding the Printer Sounds

The printer plays sounds when certain actions occur.

### ***Understanding the Printer Sounds***

| <b>Sound</b> | <b>Occurs When:</b>  |
|--------------|--|
| Power        | <ul style="list-style-type: none"><li>• You insert a battery in the printer.</li><li>• The printer starts charging the battery.</li><li>• You plug in the AC adapter.</li></ul>  |
| Hardware     | You open the media door, close the media door, or insert a cable.  |
| Button       | You press any of the buttons.  |
| Error        | <ul style="list-style-type: none"><li>• The printer cannot feed paper or print a job because of a hardware issue such as the media door open, a paper jam, or there is no media.</li><li>• An error occurs such as a paper jam, a print error, or the printer is out of range.</li></ul> |

## Understanding the Backlight

The screen backlight on the printer behaves the same way as a screen saver on your PC. After a set amount of time elapses without any user interaction, the backlight goes off. The screen backlight turns on when:

- the printer begins printing.
- you press a button.
- you connect the printer to external power.
- you are communicating with or sending data to the printer.

Use the Setup menu to change the amount of time the backlight turns off. Options for backlight are always off, always on, 5 seconds, 10 seconds, 20 seconds, 30 seconds, or 60 seconds.

## Using the Batteries

The printer uses a rechargeable 7.4 V 2300 mAh lithium-ion battery (Model AB27) for power. You must fully charge the battery before you can use the printer. The battery retains a charge for up to five days when the printer is in Standby mode.

A fully charged battery can usually print over 300 6-inch labels (PB32) or 500 6-inch labels (PB22) at 25% print density. When the printer reports low battery, it can usually print over 50 6-inch labels at 10% print density. The number of labels you can print varies depending on these factors:

- Age of the battery
- Temperature and humidity of the operating environment
- Printer configuration, including network connection settings
- Type of media loaded in the printer
- Amount of data printed for each label
- Threshold at which you configure the low battery warning



**Use Intermec Model AB27 battery only. Use of another battery may present a risk of fire or explosion.**

**The Model AB27 battery may present a fire or chemical burn hazard if mistreated. Do not disassemble, heat above 100 °C (212 °F), or incinerate. Dispose of used batteries promptly. Keep away from children.**

## **Installing the Battery**

Make sure you fully charge the battery before you use your printer. You can charge the battery before or after you install it into the printer.

### **To install the battery**

- 1** Lay the printer upside down on a flat surface.
- 2** Insert the battery with the tab facing away from the front control panel.

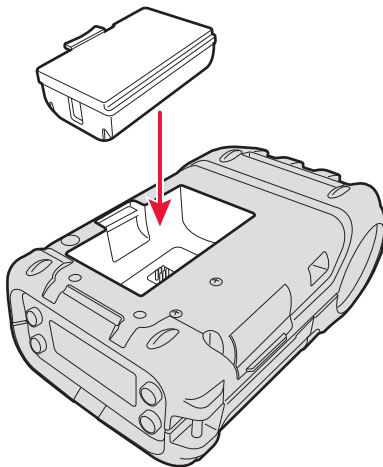

- 3** Insert the edge of the battery under the lip of the printer and then push down until you hear the battery latch click.

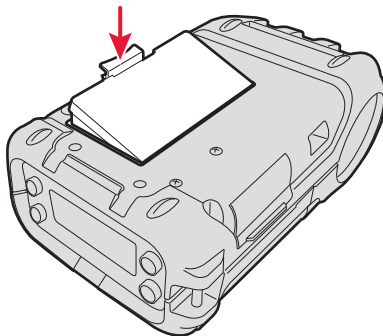

## Charging the Batteries

There are two ways to charge the printer battery:

- Charge the battery in the AC18 4-bay battery charger. It takes approximately 4 hours to charge your batteries using the 4-bay battery charger. For information, see the [AC18 4-Bay Battery Charger Instructions](#).
- Connect AC power to the printer using a 12 VDC power supply and charge the battery while it is in the printer. The battery takes approximately 3 hours to charge while it is installed in the printer.

To charge the battery inside the printer, you need:

- an Intermec 12 VDC power supply (Model AE19).
- an AC power cord.





### To charge the battery inside the printer

- 1 Install the battery in the printer. For help, see the previous section, [“Installing the Battery” on page 12](#).
- 2 Connect the power supply to the DC power connector on the printer.
- 3 Connect one end of the power cord to the power supply and then plug the other end into an AC outlet.



## Understanding the Battery Icons

The easiest way to tell the status of your battery is to look at the battery icons on the control panel of the printer.

### Battery Icon Status

| Icon  | Status   |
|---|--|
|  | Battery is fully charged.  |
|  | Battery has a medium charge. You should be able to work for several more hours before charging or replacing the battery. |
|  | Battery is low. Recharge the battery.  |
|  | Battery is critically low. You need to replace the battery now.  |

### Battery Icon Status (continued)

| Icon  | Status   |
|---|--|
|  | Battery charging error. You may need to replace the battery.     |
|  | External power connected and there is no battery in the printer. |

## Extending Battery Life

Follow these guidelines to extend the overall life of your battery:

- Never expose the battery to direct sunlight or temperatures over 50 °C (122 °F).
- Only charge the battery inside the printer using a power supply or in the 4-bay battery charger (Model AC18).
- Do not set the backlight to always on. The always on setting disabled automatic power saving modes.

Follow these guidelines to extend the life of your battery between charges:

- Press the **Standby** button to put the printer in Standby mode.
- Remove the battery if you do not need to use the printer for three days or more.
- Do not operate the printer when the ambient temperature is -20 °C (-4 °F) or lower. Using the printer in temperatures below freezing reduces the overall battery life.



**Note:** Rechargeable batteries lose their ability to maintain a charge over time. You can only recharge a battery a finite number of times before you must replace it.



# Loading Media

You can use roll or fanfold receipt media with the printer. The PB22 and PB32 ship with a test page printed to verify that the printer works. For information on media, see **“Specifications” on page 62**.

Additionally, the PB22 and PB32 also support self-strip printing. For more information on how to correctly load media for self-strip printing, see **“To load media for self-strip printing” on page 17**.

## To load media

- 1 Press down on the blue media cover release button until the cover releases.

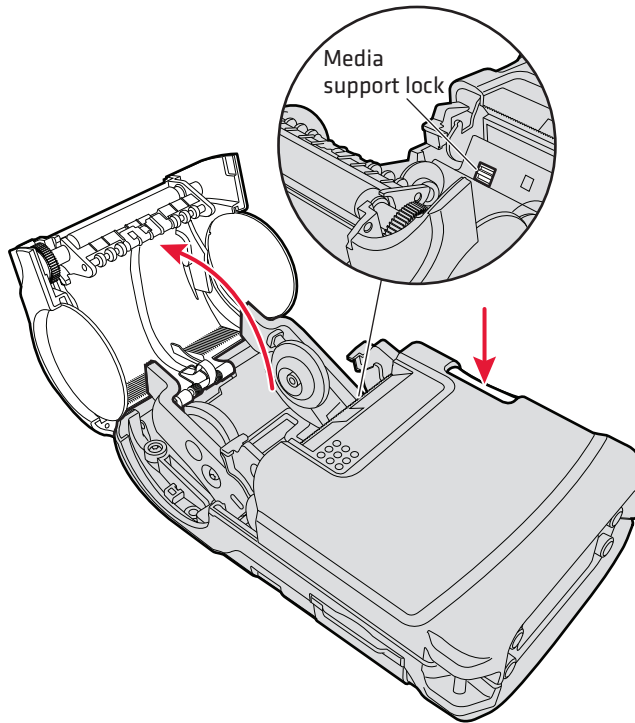

## Chapter 1 – Using the PB22 and PB32 Mobile Label and Receipt Printer

- 2 If necessary, unlock the media support lock before sliding the two media supports apart.
- 3 Insert a roll of media and close the media supports so the roll is held firmly in place. Make sure you load the media clockwise so that it pulls off the core from the bottom of the printer.

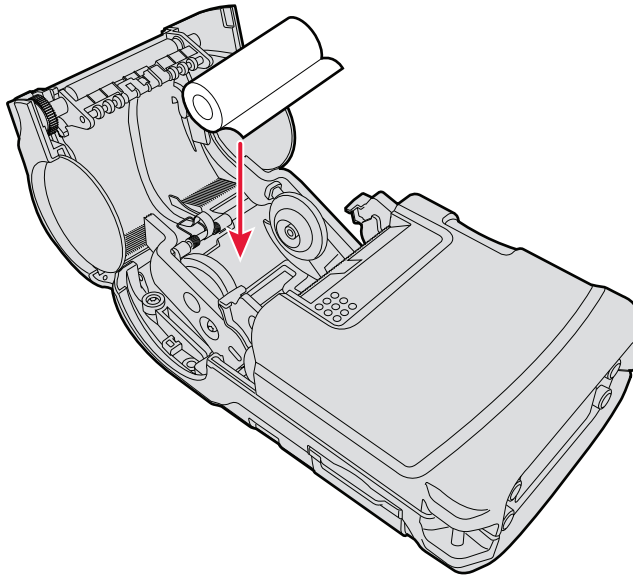

- 4 Lock the media support lock.



**Note:** The only time you need to unlock and lock the media support lock again is when you are changing to a roll with a different width.

- 5 Pull out approximately 8 cm (3 in) of the media.

- 6 Close the media cover until it latches.

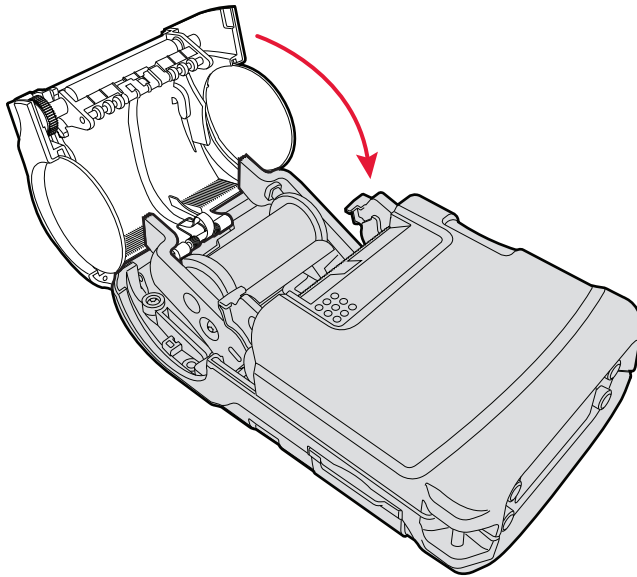

- 7 Press the **Feed** button to advance the media.

**To load media for self-strip printing**

- 1 Complete Steps 1 through 4 in the previous procedure.
- 2 Open the self-strip door in the media cover.

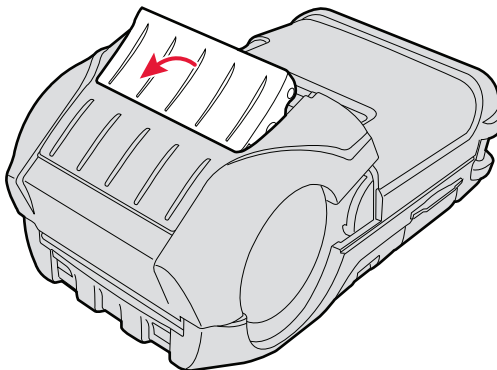

- 3 Remove a label from the roll of media so that you are left with several inches of label liner.

- 4 Feed the label liner over the self-strip bar and out the back of the self-strip door.

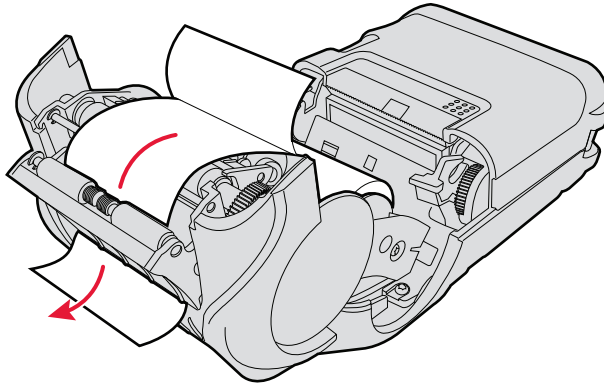

- 5 Close the media cover until it latches and press down on the self-strip door to make sure it locks. The separated liner and media spool from the self-strip mechanism.

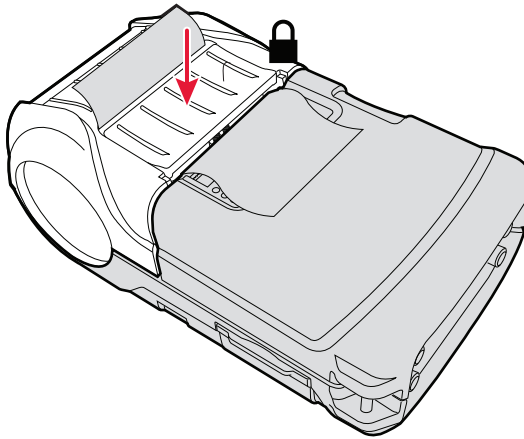

# Printing on Floodcoated Media

If you are using colored media, also known as floodcoated media, you may need to adjust the settings to enable better printing.

## To configure the printer to print on floodcoated media

- 1 Press the **Setup** button.
- 2 Press **▶** until you reach **Media**.
- 3 Press **OK** to enter the Media menu system.
- 4 Press **▶** until you reach **Advanced**.
- 5 Press **OK** to enter the Advanced menu system.
- 6 Press **▶** until you reach **Thermal Management**.
- 7 Press **OK** to enter the Thermal Management menu system.
- 8 Press **▶** until you reach **Custom TM**.
- 9 Press **OK** to select Custom TM.

## To adjust the print speed for floodcoated media

- 1 Press the **Setup** button.
- 2 Press **▶** until you reach **Media**.
- 3 Press **OK** to enter the Media menu system.
- 4 Press **▶** until you reach **Advanced**.
- 5 Press **OK** to enter the Advanced menu system.
- 6 Press **▶** until you reach **Min Speed**.
- 7 Press the **Feed** button to scroll through a list of numbers. Select a number that is appropriate for the floodcoated media. To see a list of sensitivity settings for each media type, go to **“Recommended Media Sensitivity and Constant” on page 65**.
- 8 Press **OK** to select a number.
- 9 Reboot your printer.

## Understanding the Display Modes

The printer has six display modes to help you effectively interact with the printer: Ready, Information, Pause, Setup, Error, and Test.

### Understanding Ready Mode

The printer is in Ready mode when the printer is on and ready to print. The main screen displays the power status, the radio status, and the printer language and version.

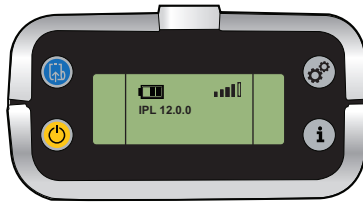

*The PB22 and PB32 in Ready Mode*

### Understanding Information Mode

When the printer is in Information mode, it displays a subset of pertinent information about the printer. If the printer experienced an error, the error message displays first followed by the printer information. Each message displays on the screen for five seconds. After five seconds on the last information screen, the printer exits Information mode.



*The PB22 and PB32 in Information Mode*

#### To enter Information mode

- Press the **Information** button on the control panel.

## Understanding Pause Mode

Use Pause mode to momentarily stop printing or to cancel a current print job. When you pause the printer, the Pause mode screen appears. Use the **Feed** button to both pause and resume printing.

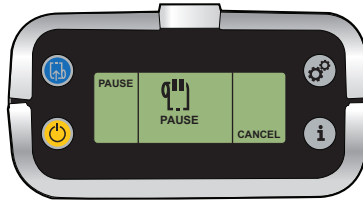

*The PB22 and PB32 in Pause Mode*

### To enter Pause mode

- Press the **Feed** button while the printer is printing.

### To resume printing

- Press the **Feed** button.

### To cancel a print job

- 1 Press the **Feed** button to pause printing (Fingerprint, IPL, or ESC/P).
- 2 Press the **Information** button (or **⊗** soft key) to cancel the print job (Fingerprint or IPL) or press and hold the **Pause** button in ESC/P.

## Understanding Setup Mode

Use Setup mode to change the settings on the printer.

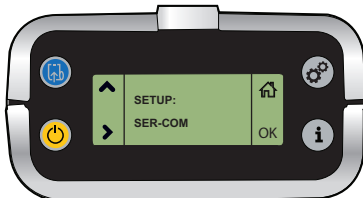

*Sample Setup Mode Screen*

### To enter or exit Setup mode

- Press the **Setup** button.

After you enter Setup mode, there are two editing modes: normal and enhanced.

### Editing Settings in Setup Mode

| Editing Mode | To Navigate   | To Accept Value   |
|--------------|---|-------------------|
| Normal       | <ul style="list-style-type: none"><li>• Press <b>▶</b> to move among choices.</li><li>• Press <b>▲</b> to go up a level in menu system.</li></ul>   | Press <b>OK</b> . |
| Enhanced     | <ul style="list-style-type: none"><li>• Press <b>▶</b> to move within the editable fields. When the field blinks, you can edit it.</li><li>• Press <b>+</b> to increase the value of the field.</li></ul> | Press <b>OK</b> . |



**Normal Editing Mode:** In normal editing mode, you see an up arrow and a right arrow for making selections.



**Enhanced Editing Mode:** In enhanced editing mode you have a plus sign and a right arrow to change the value of numeric fields.



## Understanding Error Mode

The printer enters Error mode when it detects an error condition such as a low battery or a paper fault. Some error messages appear on the screen immediately when they occur, such as DOOR OPEN. Other error messages do not appear until you press the **Information** button. If there is more than one error at a given time, the errors display in the order that they occurred.

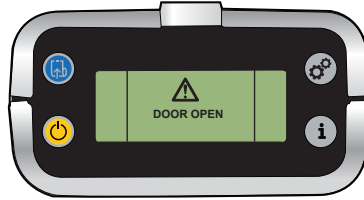

**Sample Error Mode Screen**

If you encounter an error message, see [“Understanding Error Messages” on page 50](#) for information on how to fix the problem.

## Understanding Test Mode

Use Test mode to verify printer settings, test printing, restore factory default settings, or enter Dump mode for troubleshooting purposes. Two test modes are available: Test mode and Extended Test mode.

### Using Test Mode

Test mode is a simple sequence of events that requires little user interaction. Extended Test mode requires more user interaction and lets you select which actions you want the printer to perform.

#### To enter Test mode

- 1 Make sure the printer is in Ready mode and is loaded with media.
- 2 Press and hold the **Feed** and **Standby** buttons at the same time until Select Media appears on the screen and it displays the type of media you are using.

- 3 Release both buttons. The printer performs a test feed (sensor calibration), prints, and then enters Dump mode.

The printer is now in Dump mode and it scans the communication ports. Any characters received on the communication ports are printed.

- 4 Press **Feed** to exit Dump mode.

After you exit Dump mode, the printer returns to Ready mode. For more information on Dump mode, see “**Troubleshooting Communication Problems**” on page 54.

## Using Extended Test Mode

Use Extended Test mode to run additional diagnostic tests, enter Dump mode, or reset the printer to factory defaults.



**Sample Extended Test Mode Screen**

### To enter Extended Test mode

- 1 Make sure that the printer is loaded with media.
- 2 Press the media cover release button to open the media cover.
- 3 Press the **Standby** button to turn the printer off.
- 4 Press **Feed** and **Standby** buttons at the same time until CLOSE PRINTER DOOR appears on the screen.
- 5 Close the media cover. You are now in Extended Test mode:
  - Press **➤** to cycle through the options.
  - Press **OK** to select a test option.
  - Press **⏠** to exit Extended Test mode.

### Options in Extended Test Mode

| Function        | Description  |
|-----------------|--|
| Select Media    | This option is almost the same as the process in Test mode, except that the printer performs a slow test feed in Extended Test mode. The slow test feed enables the printer to perform a slow sensor calibration which can help resolve mark detection problems. |
| Test Labels     | This option allows you to print test labels one at a time. Press <b>OK</b> to print the next label.  |
| Dump Mode       | This options enters Dump mode. For more information on Dump mode, see <b>“Troubleshooting Communication Problems” on page 54.</b>  |
| Factory Default | This option restores the factory default settings. Press <b>OK</b> to select this option and then follow the instructions on the screen.   |
| Exit to Setup   | This option exits Extended Test mode and puts the printer in Setup mode.   |
| Exit            | This option exits Extended Test mode.  |

### Changing Configuration Settings from the Display

You need to enter Setup mode before you can change configuration settings. For more information on entering Setup mode and navigating through the settings, see **“Understanding Setup Mode” on page 21.**

The top levels of the Setup menu are organized in a one-way loop. Each level has several sub-levels.



- Query: retrieve information about the printer or a print request, cancel printing, or reset the printer
- Wi-Fi: set Wi-Fi parameters

## **Printing a Test Page**

After you load media in the printer, you are ready to print a test page. You can select from several test page options for each of the printer languages. If you cannot get the test page information to print, see **“Troubleshooting the Printer” on page 50**.

### **To print a test page with a printer loaded with IPL**

- 1** Press the **Setup** button.
- 2** Press **▶** until you reach **Test/Service**.
- 3** Press **OK** to enter the Test/Service menu system.
- 4** Press **OK** to enter the Testprint Config menu.
- 5** Press **OK** to enter the Config menu.
- 6** Press **▶** to select a testprint.
- 7** Press **OK** to print the Config testprint of your choice.

### **To print a test page with a printer loaded with Fingerprint**

- 1** Press the **Setup** button.
- 2** Press **▶** until you reach **Print Defs**.
- 3** Press **OK** to enter the Print Defs menu system.
- 4** Press **▶** until you reach **Testprint**.
- 5** Press **OK** to enter the Testprint menu.
- 6** Press **▶** to select a testprint.
- 7** Press **OK** to print the testprint of your choice.

**To print a self test with a printer loaded with ESC/P**

- 1** Press and hold the **Feed** and **Power** buttons simultaneously for approximately five seconds.
- 2** Release the **Feed** and **Power** buttons when the printer displays the media you are printing on.
- 3** Press the **Feed** button to exit Dump Mode.

# 2

## Configuring the PB22 and PB32

This chapter contains these sections:

- **Connecting the Printer to Your PC**
- **Connecting the Printer to Your Network**
- **Configuring the Printer Settings**
- **Upgrading the Firmware**
- **Downloading Fonts and Graphics**

## Connecting the Printer to Your PC

You can easily connect to the printer to your PC using one of these ports:

- USB port
- RS-232 serial interface port

### Connecting the Printer Through the USB Interface

To connect the printer to your PC using the USB port, you need a USB cable (P/N 321-611-xxx) and to install Intermec InterDriver® software. To make sure you have the latest version of InterDriver, you may want to go to the downloads page for the printer on <http://www.intermec.com/support/downloads/index.aspx>.

#### To connect the printer through a USB port

- 1 Open the Interdriver executable.
- 2 The File Download - Security Warning screen appears. Click **Run** to run the executable. The Intermec End User License Agreement screen appears.
- 3 Read the agreement and select the radio button to accept the agreement, and then click **Next**. The Installation Directory screen appears.
- 4 The default installation directory is c:\Intermec\InterDriver7. Click **Next** to use the default directory or specify a different location to install the files. The Installation Information screen appears.
- 5 Clear the **Run Add Print Wizard after unpacking drivers** check box and click **Finish**.
- 6 On the New Hardware Wizard screen, select **Install from a list or specific location**, and then click **Next** to continue.



**Note:** For LPT connections, you must restart your computer for Windows to detect the new hardware. For USB connections, the New Hardware Wizard automatically launches when the printer is connected and turned on.

- 7 On the Search and Installation Options screen, click **Next**.



- 8** On the Hardware Installation warning screen, click **Continue Anyway**.
- 9** Click **Finish** to exit the New Hardware Wizard. InterDriver files are now installed on your computer.
- 10** Connect the USB cable to the connector on the back of the printer and connect the other end to your PC. You do not need to set up any parameters for USB communications.

## **Connecting the Printer Through the Serial Port**

You can use a serial cable (P/N 075497) to communicate with your PC and run PrintSet, LabelShop, or InterDriver. You can also use the serial port to send commands directly to the printer through a communications program like HyperTerminal.

The serial communication parameters control the communication between the printer and the PC connected on the serial port, referred to as “uart1:” on the printer. Make sure the serial port settings on the printer match the settings on the connected device. The default serial communication settings on the printer are: 115200 baud rate, 8 data bits, no parity, 1 stop bit, and no flow control.

The serial cable you need is not included in the shipping box with the printer.

### **To connect the printer to a PC through the serial port using PrintSet**

- 1** Connect the 8-pin circular DIN connector to the serial port on the printer. Connect the other end of the serial cable to a serial port on your PC.
- 2** Start PrintSet.
- 3** Click **File > Add printer**.  
Or, in the **General Tasks** list, click **Add printer**.
- 4** Click **Next**.
- 5** Select **Serial**, then click **Next**.
- 6** Make sure that the **COM Port** is set to the correct serial port, and that **Automatically detect communication parameters** is selected. Click **Next**.

- 7** PrintSet attempts to connect to your printer. If it cannot find your printer, click **Back** to review the communication settings, then try again. When PrintSet connects to your printer, click **Next**.
- 8** Click **Finish**. Your printer appears in the **My Printers** list.

**To connect the printer to a PC through the serial port using HyperTerminal**

- 1** Connect the 8-pin circular DIN connector to the serial port on the printer. Connect the other end of the serial cable to a serial port on your PC.
- 2** On your PC, start the communications program.
- 3** If necessary, configure the port settings so they match those of your printer:
  - Bits per second: 115200
  - Data bits: 8
  - Parity: None
  - Stop bits: 1
  - Flow control: XON\_XOFF
- 4** If you are using HyperTerminal:
  - a** Click **OK**.
  - b** Click the **Settings** tab.
  - c** Click **ASCII Setup**. The ASCII Setup window appears.
  - d** Select these check boxes:
    - **Send line ends with line feed**
    - **Echo typed characters locally**
    - **Append line feeds to incoming line ends**
- 5** Click **OK** to save and exit ASCII Setup.

**6** To test your connection, type one of these commands in your communications program window:

- For IPL, press **Ctrl** and in the communications program window simultaneously type:

b, w, c

- For Fingerprint, type:

FF

and press **Enter**.

- For ESC/P, press the **ESC** key and type:

EZ {AHEAD:10}

The printer responds by feeding a small amount of media.

## Connecting the Printer to Your Network

The printer provides two ways to connect to a network:

- Bluetooth radio communications
- 802.11 a/b/g radio communications

## Setting Up Bluetooth Communications

The printer can contain a Bluetooth radio that allows wireless communications with a remote device from distances up to 100 meters (approximately 328 feet) depending on the Bluetooth range capabilities of the remote device, environmental conditions, and obstructions. For the Bluetooth-enabled devices to exchange data, both devices must establish a connection. Bluetooth software is always running in the background.

The printer cannot initiate a Bluetooth connection. One of the devices must request a connection with the printer. The printer then accepts or rejects the connection. Use Intermec Settings on the mobile computer to enable the Bluetooth settings on the printer.

The printer can also connect to Bluetooth scanners, such as the SF51 and the SR61. You can create the bar code labels you need to connect the printer to a Bluetooth scanner using EasySet software. You can download a free version of EasySet from the Intermec website at [www.intermec.com](http://www.intermec.com).

Each printer equipped with a Bluetooth radio has a unique Bluetooth Device Address (BDA) loaded into its module when manufactured. You can find the BDA on the certification label located on the bottom of the printer.

### To set up Bluetooth communications with a mobile computer

- Follow the procedure to discover and connect to Bluetooth devices in your mobile computer user manual.





**Note:** For maximum security, you need to configure a Bluetooth passcode for the printer. The default passcode for the PB22 and PB32 is “1234.”

### To set up Bluetooth communications with a scanner

- 1 Download and install EasySet.
- 2 Create these bar code labels using EasySet:
  - Administrator reset factory defaults
  - Bluetooth parameters - security - not active
  - Bluetooth parameters - connect/disconnect - compose BT address
  - Bluetooth parameters - security - compose PIN
- 3 Scan the bar code labels with the Bluetooth scanner.

### Understanding Bluetooth Radio Icons

| Icon  | Description   |
|---|---|
|  | The Bluetooth radio is on and the printer is not connected to a serial cable.                     |
|  | The Bluetooth radio is turned off. The Bluetooth radio turns off when you connect a serial cable. |

## Setting Up 802.11 Radio Communications

The printer can have an internal 802.11 a/b/g radio to transfer and receive data using wireless communications. This manual assumes that you have already set up your wireless communications network including your access points.

To set up the printer to work in your wireless network, you need:

- serial cable (P/N 075497-xxx).
- a host PC running Windows or Linux.
- an active 802.11a/b/g wireless access point.
- a configuration application, such as PrintSet, or a communications application, such as HyperTerminal.



**Note:** If you are using IPL commands with HyperTerminal, you may want to be able to see the commands as you type them on your screen. For help, see [“Changing Configuration Settings Using the Command Line” on page 37.](#)

- to know which radio is installed in your printer.

### Determining Which Radio Is Installed in Your Printer

The available wireless communications settings depend on which radio is installed in your printer. For more information about differences in wireless communications settings, see [“Differences in Wireless Communications Settings” on page 68.](#)

#### To determine which radio is installed in your printer

- Send this Fingerprint command to the printer:

```
run "wl ver"
```

The printer returns one of these output strings:

- current radio: 4.1 RC30.8  
wl0: Feb 7 2006 15:21:43 version 4.1.30.8
- new radio: 4.1 RC30.8  
1.1.5

## Setting Up the Printer for Wireless Communications Using PrintSet

Use the PrintSet configuration application to set up wireless communications on your printer.

### To set up the printer for wireless communications using PrintSet

- 1 Connect the printer to your PC using PrintSet. For help, see **“To connect the printer to a PC through the serial port using PrintSet” on page 31.**
- 2 On your PC, start PrintSet.
- 3 Select your printer from the My Printers list.
- 4 In the **Printer Tasks** list, click **Wireless Setup Wizard.**
- 5 If prompted, type your username and password. The default username is `admin` and the default password is `pass`.
- 6 Click **Next.**
- 7 Follow the instructions to configure 802.11 radio communications and security.

## Configuring the Printer Settings

You can change the printer configuration settings from:

- the display.
- the host PC using PrintSet.
- the host PC using the command line.
- the printer home page.
- SmartSystems™.

For more information about the IPL and Fingerprint menu systems, see **“IPL and Fingerprint Setup Menus” on page 79.**

## Changing Configuration Settings From PrintSet

PrintSet is a printer configuration tool that you can download from the Intermec website. PrintSet can communicate with your printer through a serial cable or a network connection. It works on all PCs running Windows 98 (or later). PrintSet allows you to easily change all of the setup parameters. It also includes setup wizards to guide you through some common configuration tasks.

## Changing Configuration Settings Using the Command Line

You can change configuration parameters by sending commands directly to the printer using your a communications program like HyperTerminal and a serial or network connection.

If your printer is running Fingerprint, use the SETUP command, followed by the node, subnode, and parameters setting. Fingerprint automatically sends feedback to the communications program as you type. If your printer is running IPL, you need to change the HyperTerminal settings to see what you are typing.

### To see IPL commands as you type

- 1 From the HyperTerminal menu, select **File > Properties > the Settings** tab.
- 2 Click the **ASCII Setup** button.
- 3 Select **Echo typed characters locally**.
- 4 Click **OK** twice.

## Changing Configuration Settings from the Printer Home Page

If you are have a printer with an 802.11 wireless radio, you can change configuration settings from the home page of the printer.

### To make changes to the configuration

- 1 Establish a connection between your printer and the network. For help see [“Setting Up 802.11 Radio Communications” on page 35](#).
- 2 Connect your PC to the same network that the printer is on.
- 3 Change the printer language to Fingerprint or IPL. For help, see [“Changing the Printer Language” on page 7](#).

- 4 If you are using Fingerprint or IPL:
  - a Press the **Setup** button.
  - b Press the **▶** until you reach **Network**.
  - c Press **OK** to enter the Network system menu.
  - d Press **▶** until you reach **IP address**.
  - e Press **OK** to view the IP address.
- 5 Start a web browser.
- 6 In the address field, type the IP address of your printer and press **Enter**. The home page of the printer appears.
- 7 Click **Login** and enter your administrator name and password.
- 8 On the home page of the printer, click **Configuration**.

For help with Fingerprint, IPL, ESC/P, or SmartSystems commands and information, see one of these documents:

- *Intermec Fingerprint Command Reference Manual*
- *Intermec Printer Language (IPL) Command Reference Manual*
- *ESC/P Programmer's Reference Manual*
- SmartSystems Online Help.

You can download these documents from the Intermec website at [www.intermec.com](http://www.intermec.com).

## Changing Configuration Settings Using SmartSystems

You can use the SmartSystems console to change configuration settings on your printer. The printer ships with the SmartSystems client loaded on it. The console is part of SmartSystems and is available from the Intermec website. To download SmartSystems, go to [www.intermec.com/products/smrtsysfoundation/index.aspx](http://www.intermec.com/products/smrtsysfoundation/index.aspx).

## Upgrading the Firmware

The latest firmware and software is available for download from the Intermec website at [www.intermec.com](http://www.intermec.com). You can upgrade the firmware on your printer using:



- PrintSet. You can download PrintSet from the downloads page for the printer on the Intermec website at [www.intermec.com](http://www.intermec.com).
- the printer home page.

- SmartSystems.
- a serial cable and a communications program, like HyperTerminal.



**When upgrading your firmware, make sure the battery in the printer is fully charged. If the printer loses power during the upgrade, the printer may be permanently damaged.**

## Upgrading the Printer Firmware Using PrintSet

You can only upgrade your printer using PrintSet when the printer is running IPL, Fingerprint, or ESC/P printer languages. To upgrade the printer using PrintSet, you need to install PrintSet to your PC and purchase a serial cable (P/N 075497).

### To upgrade the printer firmware using PrintSet

- 1** If your printer is running ZSim or DSim, change the printer language to IPL, Fingerprint, or ESC/P. For help, see **“Changing the Printer Language” on page 7**.
- 2** Connect your printer to your PC using a serial cable. For help, see **“Connecting the Printer Through the Serial Port” on page 31**.
- 3** Download the firmware upgrade file (.bin) to your PC:
  - a** Go to [www.intermec.com](http://www.intermec.com).
  - b** Click **Support > Downloads**.
  - c** Use the **Product Category**, **Product Family**, and **Product fields**, to select the printer model.
  - d** Click **Submit**. The available software appears.
  - e** Download the latest firmware version to your PC.
  - f** Extract the .zip file to a folder on your PC.

4 Start PrintSet.

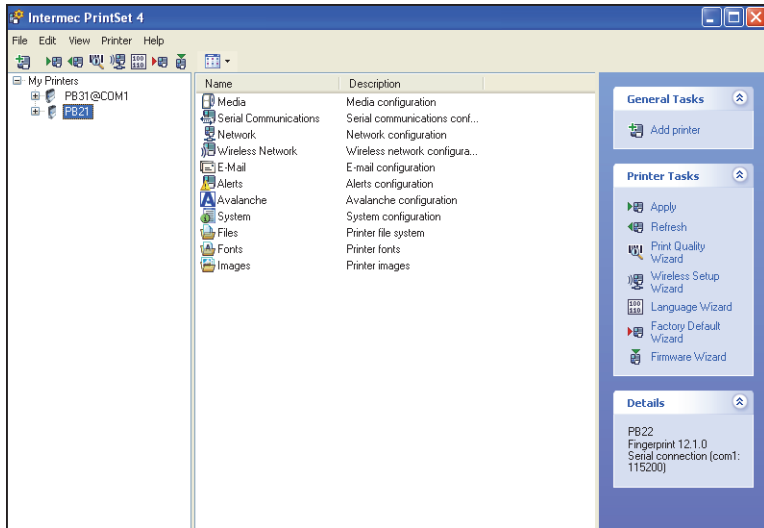

5 Under **My Printers**, click the printer you want to upgrade.

6 On the right, under **Printer Tasks** click **Firmware Wizard**.

7 Click **Next**. The Firmware Wizard dialog box appears.

8 Click **Browse** and navigate to the firmware upgrade file (.bin).

Wait approximately 5 minutes for the firmware upgrade to finish.

## Upgrading the Printer Firmware Using the Printer Home Page

You can upgrade your printer using the printer home page with a printer with an 802.11 radio running IPL or Fingerprint.

### To upgrade using the printer home page

1 Establish a connection between your printer and the network. For help, see [“Setting Up 802.11 Radio Communications” on page 35](#).

2 Establish a connection between your PC and the network your printer is on.

- 3 Download the firmware upgrade file (.bin) to your PC:
  - a Go to [www.intermec.com](http://www.intermec.com).
  - b Click **Support** > **Downloads**.
  - c Use the **Product Category**, **Product Family**, and **Product fields**, to select the printer model.
  - d Click **Submit**. The available software appears.
  - e Download the latest firmware version to your PC.
  - f Extract the .zip file to a folder on your PC.
- 4 If you are using Fingerprint or IPL, use the display to find the printer's IP address:
  - a Press the **Setup** button.
  - b Press **▶** until you reach Network.
  - c Press **OK** to enter the Network menu.
  - d Press **▶** until you reach IP Address.
  - e Press **OK** to select and view the IP Address.
  - f Press the **Setup** button to exit the menu.
- 5 Start a web browser.
- 6 In the address field type the IP address of your printer and press **Enter**.

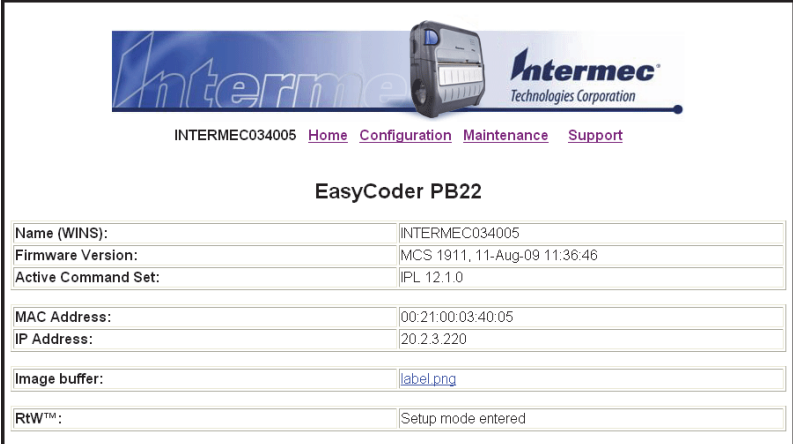

The screenshot shows the Intermec EasyCoder PB22 web interface. At the top, there is a navigation bar with the Intermec logo and a small image of the printer. Below the navigation bar, the printer model "EasyCoder PB22" is displayed. The main content area contains a table with the following information:

|                     |                              |
|---------------------|------------------------------|
| Name (WINS):        | INTERMEC034005               |
| Firmware Version:   | MCS 1911, 11-Aug-09 11:36:46 |
| Active Command Set: | IPL 12.1.0                   |
| MAC Address:        | 00:21:00:03:40:05            |
| IP Address:         | 20.2.3.220                   |
| Image buffer:       | <a href="#">label.png</a>    |
| RtW™:               | Setup mode entered           |

7 Click **Maintenance**. The Maintenance page appears.

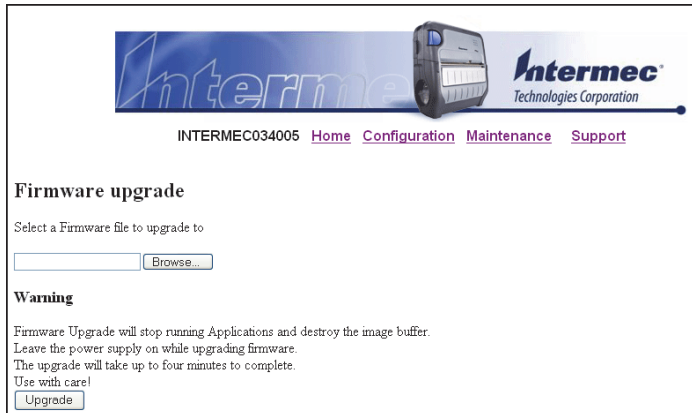

8 When prompted, enter your user name and password.

9 Browse to the firmware upgrade file (.bin) and select it.

10 Click **Upgrade**.

Wait approximately 5 minutes for the firmware upgrade to finish. The printer automatically reboots.

## Upgrading Printer Firmware Using SmartSystems

You can use the SmartSystems console to upgrade the printer firmware. Your printer ships with the SmartSystems client loaded on it. The console is part of SmartSystems and is available from the Intermec website. To download SmartSystems, go to [www.intermec.com/products/smrtsysfoundation/index.aspx](http://www.intermec.com/products/smrtsysfoundation/index.aspx).

## Upgrading the Printer Firmware Using a Communications Program

You can upgrade your printer firmware using a communications program, like HyperTerminal, and a printer running either the IPL, Fingerprint or ESC/P printer language.



**Note:** Intermec recommends using PrintSet or the printer home page to upgrade the printer firmware. For help, see **“Upgrading the Printer Firmware Using PrintSet”** on page 40 or **“Upgrading the Printer Firmware Using the Printer Home Page”** on page 41.

**To upgrade printer firmware using a communications program and IPL**

- 1 Connect your printer to your PC using a serial cable. For help, see **“Connecting the Printer Through the Serial Port” on page 31**.  
Or,  
Establish a connection between your printer and your network.  
**“Connecting the Printer to Your Network” on page 33.**
- 2 If you connected your printer to the network, establish a connection between your PC and the network your printer is on.
- 3 Download the firmware upgrade file (.bin) to your PC:
  - a Go to **[www.intermec.com](http://www.intermec.com)**.
  - b Click **Support > Downloads**.
  - c Use the **Product Category**, **Product Family**, and **Product fields**, to select the printer model.
  - d Click **Submit**. The available software appears on the page.
  - e Download the latest firmware version to your PC.
  - f Extract the .zip file to a folder on your PC.
- 4 Start a communications program, like HyperTerminal.
- 5 In the communications program window, type this command:  
`<STX><ESC> .y, ush<ETX>`
- 6 Press **Enter**. You are prompted to enter more information.
- 7 Type this command:  
`su -p pass admin.`
- 8 Type this command:  
`dlk -z`  
The printer indicates that it is “Upgrading.”
- 9 In the communications program window, click **Transfer > Send File**. A dialog box appears.
- 10 In the protocol drop-down box, select **Zmodem**.

- 11** Browse to the firmware upgrade file (.bin) and select it.  
Wait approximately 5 minutes for the firmware upgrade to finish. When the upgrade is complete, the communications program displays the message, “kernal flashing ok.” The printer automatically reboots.

**To upgrade printer firmware using a communications program and Fingerprint**

- 1** Connect your printer to your PC using a serial cable. For help, see **“Connecting the Printer Through the Serial Port” on page 31.**
- 2** Download the firmware upgrade file (.bin) to your PC:
  - a** Go to [www.intermec.com](http://www.intermec.com).
  - b** Click **Support > Downloads**.
  - c** Use the **Product Category**, **Product Family**, and **Product fields**, to select the printer model.
  - d** Click **Submit**. The available software appears.
  - e** Download the latest firmware version to your PC.
  - f** Extract the .zip file to a folder on your PC.
- 3** Start a communications program, like HyperTerminal.
- 4** Type this command:  

```
run "su -p pass admin"
```
- 5** Type this command:  

```
run "dlk -z"
```

The printer indicates that it is “Upgrading.”
- 6** In the communications program window, click **Transfer > Send File**. A dialog box appears.
- 7** In the protocol drop-down box, select **Zmodem**.
- 8** Browse to the firmware upgrade file (.bin) and select it.  
Wait approximately 5 minutes for the firmware upgrade to finish. When the upgrade is complete, the communications program displays the message, “kernal flashing ok.” The printer automatically reboots.

**To upgrade printer firmware using a communications program and ESC/P**

- 1 Connect your printer to your PC using a serial cable. For help, see “[Connecting the Printer Through the Serial Port](#)” on page 31.
- 2 Download the firmware upgrade file (.bin) to your PC:
  - a Go to [www.intermec.com](http://www.intermec.com).
  - b Click **Support** > **Downloads**.
  - c Use the **Product Category**, **Product Family**, and **Product fields**, to select the printer model.
  - d Click **Submit**. The available software appears on the page.
  - e Download the latest firmware version to your PC.
  - f Extract the .zip file to a folder on your PC.
- 3 Start a communications program, like HyperTerminal.
- 4 Reboot the printer.
- 5 Press **Esc**.
- 6 Type this command:  
`{SYS:USH}`
- 7 Type this command:  
`su -pass admin.`
- 8 Type this command:  
`dlk -z.`  
The printer indicates that it is “Upgrading.”
- 9 In the communications program window, click **Transfer** > **Send File**. A dialog box appears.
- 10 In the protocol drop-down box, select **Zmodem**.
- 11 Browse to the firmware upgrade file (.bin) and select it.  
  
Wait approximately 5 minutes for the firmware upgrade to finish. When the upgrade is complete, the communications program window displays the message, “kernal flashing ok.” The printer automatically reboots.



## Downloading Fonts and Graphics

The easiest way to download fonts and graphics is to use PrintSet. You can download PrintSet from the downloads page for the printer on the Intermec website at [www.intermec.com](http://www.intermec.com). Follow the procedures in the PrintSet online help to download fonts and graphics.

For help with Fingerprint, IPL, ESC/P, or SmartSystems commands and information, see either the *Intermec Fingerprint Command Reference Manual*, the *Intermec Fingerprint Developer's Guide*, the *ESC/P Programmer's Reference Manual*, or SmartSystems online help. You can download these documents from the Intermec website at [www.intermec.com](http://www.intermec.com).



# 3

## Troubleshooting and Maintaining the PB22 and PB32

Use this chapter to solve problems you may encounter while using the PB22 and PB32. This chapter contains these sections:

- **Troubleshooting the Printer**
- **Resetting the Printer**
- **Cleaning the Printer**

## Troubleshooting the Printer

You may have printer operation, print quality, or printer communication problems at some time during the life of the printer. It is easy to fix most of the problems and you will find solutions in “**Troubleshooting Printer Problems and Finding Solutions**” on [page 52](#). If you cannot find the answer to your problem, you may need to contact Product Support.

### Contacting Product Support

Before you call Intermec Product Support, you may want to visit the Intermec technical knowledge base (Knowledge Central) at [intermec.custhelp.com](http://intermec.custhelp.com) to review technical information or to request technical support. If you still need help after visiting Knowledge Central, you may need to call Product Support.

To talk to an Intermec Product Support representative in the U.S.A. or Canada, call:

**1-800-755-5505**

Outside the U.S.A. and Canada, go to [www.intermec.com](http://www.intermec.com) and click **Contact** to find your local Intermec representative.

Before you call Intermec Product Support, make sure you have this information ready:









- Printer serial number
- Firmware type and version
- Bluetooth, wireless, or serial port settings

You can find all of the information listed above in the printer menu system or on a test print page.

### Understanding Error Messages

Use this table to troubleshoot some common error messages you may see on the printer screen. Some of the error messages are specific to the type of firmware you have loaded on your printer.

**Possible Printer Error Icons and Messages**

| Error Icon  | Error Message                                 | Description  |
|---|---|--|
|    | Pause   | The print job is paused.   |
|    | Paper out (IPL)<br>Out of Paper (Fingerprint) | The printer is out of paper. Load a new roll of media. For help, see <b>“Loading Media” on page 15</b> .   |
|    | Testfeed not done                             | The printer did not perform a test feed before printing. It is important to perform a test feed because it calibrates the sensor.<br><br>To perform a testfeed: <ul style="list-style-type: none"> <li>• In Fingerprint and ESC/P, press the <b>Feed</b> button for more than 1 second.</li> <li>• In IPL Start and close the media door and then Press the <b>Feed</b> button.</li> </ul> |
|    | Printhead hot                                 | The printhead is overheated and needs to cool down. In IPL, wait for printing to resume automatically. In Fingerprint and ESC/P, you need to restart your print job.   |
|    | Upgrading                                     | The printer is loading new firmware.   |
|    | LSS too high,<br>LSS too low                  | These errors can occur when you run a test feed without any media installed, or if you have incorrect media settings.<br><br>Load the printer with media (see <b>“Loading Media” on page 15</b> ), run Test mode (see <b>“Understanding Test Mode” on page 23</b> ), and select the appropriate media type.  |
|  | IP configuration error                        | The printer is trying to acquire an IP address from the network. Wait for the printer to complete the task before taking any action.   |
|  | IP link error                                 | No network connection.   |
|  | Field out of label                            | You are attempting to print in an area that extends beyond the print window. See the programmer’s reference manual for your type of firmware (IPL, Fingerprint, or ESC/P) for information on how to set the media parameters.  |

**Possible Printer Error Icons and Messages (continued)**

| Error Icon  | Error Message | Description   |
|---|---------------|---|
|  | Door open     | The printer is not completely closed. Press down on the media cover to make sure it is latched. |

## Troubleshooting Printer Problems and Finding Solutions

Use this table to troubleshoot some common problems you may encounter with the printer.

**Printer Problems and Solutions**

| Problem   | Possible Solution  |
|---|--|
| The printer does not turn on when you press <b>Standby</b> .    | <ul style="list-style-type: none"> <li>• Replace the battery with a charged battery.</li> <li>• Connect external power to make sure the printer works correctly and to charge the battery.</li> </ul>  |
| The blue light (Ready-to-Work indicator) is blinking.           | <ul style="list-style-type: none"> <li>• Make sure media is loaded and the media cover is closed. For help, see <b>“Loading Media” on page 15</b>.</li> <li>• There is a printing error. The screen displays an error message containing information on the error.</li> <li>• The printer is paused. The printer is cancelling a print job.</li> </ul> |
| Printer keeps printing or feeding when it should stop.          | <ul style="list-style-type: none"> <li>• Check media settings.</li> </ul>  |
| The printout is not in the desired position.                    | <ul style="list-style-type: none"> <li>• Check for errors in the software application.</li> </ul>  |
| The printer is not printing with an 802.11 wireless connection. | <ul style="list-style-type: none"> <li>• Verify that the wireless settings are correct. For help, see <b>“Setting Up 802.11 Radio Communications” on page 35</b>.</li> <li>• Make sure the printer has an IP address.</li> <li>• Make sure the printer is connected to the network.</li> <li>• Make sure the printer is in Ready mode.</li> </ul>      |

**Printer Problems and Solutions (continued)**

| Problem  | Possible Solution  |
|--|--|
| <p>The printer is not printing with a Bluetooth connection.</p>    | <ul style="list-style-type: none"> <li>• Re-establish a Bluetooth connection with the mobile computer or scanner. For help, see your mobile computer user’s manual or <b>“Setting Up Bluetooth Communications” on page 33.</b></li> <li>• Make sure the mobile computer can print to a known good printer.</li> <li>• Print a Bluetooth test print page to make sure that the mobile computer discovered your printer. For help, see <b>“Printing a Test Page” on page 27.</b></li> <li>• Make sure the printer is in Ready mode.</li> </ul> |
| <p>Printout is faded or weak.</p>                                  | <ul style="list-style-type: none"> <li>• Fingerprint users: adjust the media constant/factor and contrast (-10% to +10%).</li> <li>• IPL users: adjust the media sensitivity setting (-10 to +10).</li> <li>• ESC/P users: adjust the Media Sensitivity command or the Set Dark Adjust command. For help, see the <i>ESC/P Programmer’s Reference Manual.</i></li> <li>• Check to see if the printhead needs cleaning. For help, see <b>“Upgrading the Firmware” on page 38.</b></li> </ul>  |
| <p>The battery charge is not lasting as long as it should.</p>     | <ul style="list-style-type: none"> <li>• Check the battery date. If the battery is a few years old, the shortened life may be due to normal aging.</li> <li>• Replace the battery.</li> </ul>  |
| <p>The AC18 4-bay battery charger is not charging the battery.</p> | <ul style="list-style-type: none"> <li>• Make sure that the battery is seated properly in the charger and the charging status light is on. For help, see the <i>AC18 4-Bay Battery Charger Instructions.</i></li> <li>• Contact Intermec Product Support.</li> </ul>   |
| <p>The test pages do not print.</p>                                | <ul style="list-style-type: none"> <li>• Make sure that the blue light is not blinking. If it is, make sure your printer has media and that the media cover is closed.</li> <li>• Make sure that you can advance media by pressing the <b>Feed</b> button.</li> </ul>  |

### Printer Problems and Solutions (continued)

| Problem                | Possible Solution  |
|------------------------|--|
| Print quality is poor. | <ul style="list-style-type: none"><li>• Clean the printhead. For help, see <b>“Upgrading the Firmware” on page 38.</b></li><li>• Check the battery and recharge or replace as necessary. For help, see <b>“Charging the Batteries” on page 13.</b></li><li>• Check the quality of the media. Use only Intermec media to ensure superior print quality and product performance.</li><li>• Check that the printer is set to the appropriate Constant/Factory or sensitivity number for the media you are using. If you are using floodcoated media, see <b>“Printing on Floodcoated Media” on page 19.</b></li></ul> |

## Troubleshooting Communication Problems

Use Dump mode to verify that the printer is receiving data from the host correctly.

### Using the Line Analyzer in Fingerprint

In Dump mode, the printer runs a Fingerprint program called Line Analyzer. The Line Analyzer captures incoming characters on the communication ports and prints them.

The easiest way to enter Dump mode is through Test mode or Extended Test mode. For help, see **“Understanding Test Mode” on page 23.**

After the printer enters Dump mode, it tells you it has entered Dump mode by printing it on a label. The display shows the Dump mode icon and printer is ready to receive data.

While the printer is receiving data, the Ready-to-Work indicator blinks. After a half of a second, if no more characters have been received, the printer times out. The program considers the transmission terminated and prints out a label.

Printable characters are printed in black-on-white. Control characters and space characters (ASCII 000 to 032 dec) are printed in white-on-black.



As long as a continuous string of characters is being received, the program wraps the lines until the label is full and then starts to print another label. After each character transmission, this information prints:

- Page number
- Number of characters printed on the label
- Total number of characters received so far

When you exit Dump mode, a final label prints to inform you that it is exiting from Dump mode.

### Using Dump Mode in IPL

When you enter Dump mode, the printer captures incoming characters on the communication ports and prints them on one or more labels.

If you have IPL firmware on your printer, you can access Dump mode in two different ways with slightly different results:

- You can access Dump mode through Test mode or Extended Test mode and you will receive printouts that look exactly like those produced with the Line Analyzer program in Fingerprint. For more information, see the previous procedure, [“Using the Line Analyzer in Fingerprint” on page 54](#).
- You can access Dump mode from the Setup menu. If you access Dump mode this way, characters are printed on a continuous line along with corresponding hexadecimal numbers.

#### To enter Dump mode from the Setup menu

- 1 Press the **Setup** button.
- 2 Press **➤** until you reach **Test/Service**.
- 3 Press **OK** to enter the Test/Service menu.
- 4 Press **➤** until you reach **Data Dump** and then press **OK**.
- 5 Press **➤** to select Yes and then press **OK**.
- 6 Cold boot the printer to exit Dump mode. For help, see the next section.

## Resetting the Printer

You rarely need to reset the printer, unless you are upgrading the firmware. If your printer occasionally locks up, you will want to reset it. A reset reinitializes the 802.11 radio and clears the working memory.



**Note:** The Setup menu is not affected by a reset. Your printer retains all of your configuration settings after the printer powers back up.

### To reset the Printer

- 1 Disconnect the printer from power if externally powered.
- 2 Remove the battery from the printer for at least one second.
- 3 Insert the battery back into the printer.
- 4 Reconnect external power if your printer is externally powered.

## Cleaning the Printer

To properly maintain your printer, you must clean it at the recommended interval. Use the next illustration to locate the parts of your printer to clean.

Make sure to clean these parts:

- Printhead
- Platen roller
- Paper sensors
- Tear bar
- Printer exterior
- Media compartment



Warning

**To avoid possible personal injury or damage to the printer, never insert any pointed or sharp objects into the printer.**



Use only the cleaning agents specified in this section. Intermec is not responsible for damage caused by any other cleaning materials used on this printer.

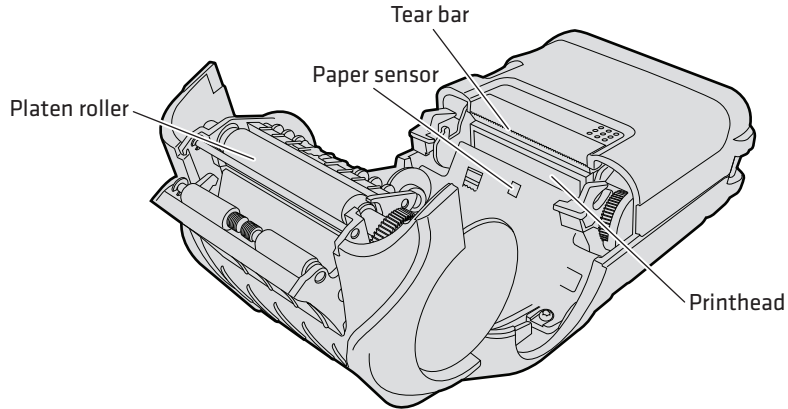

**PB22 and PB32 Mobile Label and Receipt Printer:** You need to clean these parts regularly.

## Cleaning the Printhead

Clean the printhead every five rolls of media to prolong the life of the printhead and ensures that you maintain high print quality.

Clean the printhead with the cleaning swab. The cleaning swab is shipped with the printer and can also be purchased separately from [www.intermec.com](http://www.intermec.com).



**Note:** The cleaning swab is the recommended method for cleaning the printhead and platen roller. Using other methods for cleaning may damage the printer.

### To clean the printhead

- 1 Open the media cover.
- 2 Remove the media and ribbon.
- 3 Use the cleaning swab or cleaning pen to dissolve any contamination on the line of heat-emitting objects at the front/ bottom of the printhead.
- 4 Wait 30 seconds and carefully rub off any contamination.

- 5 Repeat Steps 3 and 4 if necessary.
- 6 Allow the printhead to dry for a minute or more before loading a new supply of media and ribbon.

## **Cleaning the Platen Roller**

Regular cleaning of the platen roller every five rolls of media prolongs the life of the printhead and ensures that you maintain high print quality.

Clean the printhead with the cleaning swab. The cleaning swab is shipped with the printer and can also be purchased separately from [www.intermec.com](http://www.intermec.com).



**Note:** The cleaning swab is the recommended method for cleaning the printhead and platen roller. Using other methods for cleaning may damage the printer.

### **To clean the platen roller**

- Rotate the platen roller and clean it thoroughly with the cleaning swab.

Be sure to clean these parts using the cleaning swab:

- Paper sensors
- Tear bar

## **Cleaning the Printer Exterior**

Make sure to keep the exterior of the printer clean, this will reduce the risk of dust or foreign particles reaching the inside of the printer and affect printer functionality.

### **To clean the printer exterior**

- 1 Close the media cover.
- 2 Use a soft cloth, possibly moistened with water or a mild detergent and wipe the printer exterior.

Make sure to keep the surface surrounding the printer clean as well.

## **Cleaning the Printer Media Compartment**

- 1** Open the media cover.
- 2** Remove the media and ribbon.
- 3** Use a brush or air blow the compartment.  
Make sure the paper sensors are free of dust.



# A

## Specifications

# Specifications

This section lists the physical and environmental specifications for the printers.

## ***PB22 Physical Dimensions***

|         |                             |
|---------|-----------------------------|
| Depth:  | 71.1 mm (2.8 in)            |
| Height: | 176.4 mm (6.9 in)           |
| Width:  | 101.6 mm (4.0 in)           |
| Weight: | 678 g (1.5 lb) with battery |

## ***PB32 Physical Dimensions***

|         |                             |
|---------|-----------------------------|
| Depth:  | 81.6 mm (3.2 in)            |
| Height: | 182.2 mm (7.2 in)           |
| Width:  | 127.6 mm (5.0 in)           |
| Weight: | 828 g (1.8 lb) with battery |

## ***Power Specifications***

|                           |   |
|---------------------------|---|
| AC power adapter voltage: | 100 to 240 V, 47 to 63 Hz                       |
| Printer voltage:          | 12 VDC, 4.0 A                                   |
| Operating power:          | Rechargeable 7.4 V 2300 mAh lithium-ion battery |

## ***Temperature and Humidity Specifications***

|                        |  |
|------------------------|--|
| Operating temperature: | -15 °C to 50 °C (-5 °F to 122 °F)                                      |
| Storage temperature:   | -30 °C to 70 °C (-22 °F to 158 °F)                                     |
| Charging temperature:  | 0 °C to 45 °C (32 °F to 113 °F)  |
| Relative humidity:     | 10 to 90% non-condensing   |
| Sealing:               | IP54 is used. Paper path and card reader slots are excluded from IP54. |



**Memory**

|        |       |
|--------|-------|
| RAM:   | 16 MB |
| Flash: | 64 MB |

**Print Speed and Resolution**

|              |                     |
|--------------|---------------------|
| Print speed: | 4 ips (100 mm/s)    |
| Resolution:  | 203 dpi (8 dots/mm) |

**Print Technology**

|                      |  |
|----------------------|--|
| Printhead:           | Direct thermal                             |
| Maximum print width: | PB22 48 mm (1.8 in)<br>PB32 72 mm (2.8 in) |

**Media Specifications**

|   |  |
|---|--|
| Minimum black mark length:                | 3.17 mm (0.125 in)                                 |
| Minimum notch length:                     | 6.35 mm (0.25 in)                                  |
| Minimum notch width (on center of media): | 12.7 mm (0.50 in)                                  |
| Black mark width:                         | Full width of media                                |
| Core inside diameter:                     | 19.05 mm (0.75 in)                                 |
| Roll outside diameter:                    | PB22 57.15 mm (2.25 in)<br>PB32 67.31 mm (2.65 in) |
| Tracking:                                 | Center   |
| Maximum caliper for tags:                 | 0.15 mm (0.006 in)                                 |
| Minimum media length:                     | 12.7 mm (0.5 in)                                   |
| Maximum media length:                     | Continuous   |

## Appendix A – Specifications

When you order printer media, keep these points in mind:

- Gap, notch, and black marks are used as repeat indicators:
  - Gap: Label and fanfold media
  - Notch: Tag media
  - Black mark: Tag and fanfold media. Black marks are sensed on the side of the media that is thermally sensitive.
- You can use higher caliper media in the printer, but print quality will be reduced.
- Receipt roll stock media is supplied as a continuous roll and has an end of roll indicator. The end of roll indicator is a red marking (on last 3 feet of roll) on the side of the paper that is thermally sensitive.

### **External Fanfold Media Specifications**

|               |                                 |
|---------------|---------------------------------|
| Stack height: | 70 mm (2.75 in)                 |
| Page length:  | 152 mm (6 in) to 305 mm (12 in) |



**Note:** A 6-inch page length is supplied in 12-inch long stacks (two 6-inch stacks of equal height with the bottom page linked).

Specialty media is required for unique customer environments, including printer operating temperature extremes. Intermec recommends that you test the media in your application.

### **Supported Media**

The printer supports direct thermal label, tag, and receipt media. Both North American and European label media are supported in multiple label lengths. Receipt media is supported in both a top coated and an uncoated paper in continuous roll stock only.



**Note:** To configure the printer for coated media (floodcoated media), see **“Printing on Floodcoated Media” on page 19**.

The default media sensitivity number is 180. Use this table as a guide when setting sensitivity numbers.

**Recommended Media Sensitivity and Constant**

| <b>Sensitivity</b>          | <b>Constant</b> | <b>Description</b>                    |
|-----------------------------|-----------------|---------------------------------------|
| North American Label Media  |                 |                                       |
| 720                         | 60              | Duratherm Lightning Plus              |
| 470                         | 52              | Duratherm Lightning Perm              |
| 450                         | 48              | Duratherm III IR                      |
| 430                         | 100             | Duratherm III Synthetic               |
| 180                         | 80              | Duratherm II Label                    |
| 180                         | 80              | Duratherm III Label                   |
| 180                         | 80              | Duratherm Near IR                     |
| 150                         | 70              | Duratherm 5 mil Tag                   |
| North America Receipt Media |                 |                                       |
| 401                         | 85              | Duratherm TC                          |
| 102                         | 32              | Duratherm NTC - 2                     |
| 101                         | 30              | Duratherm NTC                         |
| 104                         | 80              | Duratherm Receipt - Fanfold           |
| 103                         | 100             | Duratherm Linerless                   |
| 430                         | 100             | Duratherm II Floodcoated (NTC)        |
| 180                         | 80              | Duratherm III Floodcoated (TC)        |
| 180                         | 80              | Duratherm III NIR Floodcoated (FedEx) |
| European Label Media        |                 |                                       |
| 440                         | 47              | Thermal Eco                           |
| 140                         | 70              | Thermal Top                           |
| 120                         | 47              | Thermal Eco Board 140 gr              |

# Interfaces

This section describes the standard interfaces available on the PB22 and PB32 printers.

## RS-232 Serial Interface

The serial adapter is an 8-pin DIN to DB9 connector that connects from the printer to your desktop PC.

### Serial Port Default Settings

| Parameter                     | Default Setting                      |
|-------------------------------|--------------------------------------|
| Baud rate                     | 115200                               |
| Character Length or Data Bits | 8                                    |
| Parity                        | None                                 |
| Stop Bits                     | 1                                    |
| Handshaking                   | None (Fingerprint)<br>XON/XOFF (IPL) |

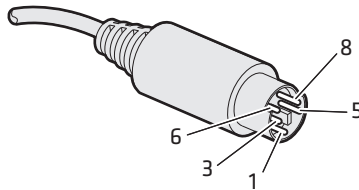

### Serial Cable (Printer End)

### Serial Cable Pinouts (Printer End)

| Pin | Signal  | Description                         |
|-----|---------|-------------------------------------|
| 1   | HHC RXD | Receive data from host (input)      |
| 3   | HHC CTS | Clear to send from printer (output) |
| 5   | HHC RTS | Request to send from host (input)   |
| 6   | HHC TXD | Transmit data to printer (output)   |
| 8   | GND     | Ground                              |

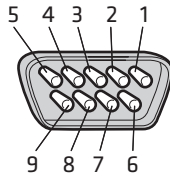

**RS-232 Serial Cable DB9 Pins (PC End)**

**Serial Cable Pinouts (PC End)**

| Pin | Signal | Description                         |
|-----|--------|-------------------------------------|
| 1   | DCD    | Data carrier detect                 |
| 2   | RXD    | Receive data from host (input)      |
| 3   | TXD    | Transmit data to printer (output)   |
| 4   | DTR    | Data terminal ready                 |
| 5   | GND    | Ground                              |
| 6   | DSR    | Data set ready                      |
| 7   | RTS    | Request to send from host (input)   |
| 8   | CTS    | Clear to send from printer (output) |
| 9   | RI     | Ring indicator                      |

## USB Interface

To use the USB interface to print from a PC, you need to have the Intermec InterDriver printer driver installed on your PC. For help setting up USB communications, see [“Connecting the Printer Through the USB Interface” on page 30](#).

The USB cable that ships with the printer has a USB Type A connector on one end to connect to the PC and a USB Type B connector on the other end to connect to the printer. You do not need to configure communications for the USB port.

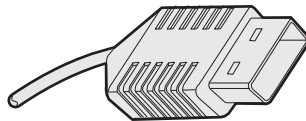

**USB Type A Connector**

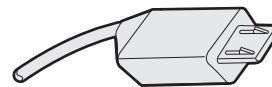

**USB Type B Connector**

# Differences in Wireless Communications Settings

There are two 802.11 radios available for your printer. Some wireless communications settings differ depending on which radio is installed. To determine which radio is installed, see [“Determining Which Radio Is Installed in Your Printer” on page 35](#).

## Differences in Wireless Communications Settings

| Setting    | Current Radio  | New Radio  |
|------------|--|--|
| AUTH       | <p>Specifies the security method the printer uses to grant access to the wireless network:</p> <ul style="list-style-type: none"> <li>• Open (default)</li> <li>• Shared</li> <li>• Auto</li> </ul>  | <p>Specifies the security method the printer uses to grant access to the wireless network.</p> <p>The only supported method is Open.</p>   |
| BAND       | Not Supported  | <p>Configures the band in which the radio needs to be configured:</p> <ul style="list-style-type: none"> <li>• 2.4 GHz (default)</li> <li>• 5 GHz</li> </ul>   |
| CHANNEL    | <p>If you select Adhoc as the NETWORK TYPE, specifies the channel (from 1 through 14) over which to transfer data.</p> <p>Default: 1</p>   | <p>If you select DIRECT as the MODE, specifies the channel (based on the .REGION and BAND settings) over which to transfer data.</p> <p>Default: 1 (DIRECT) for 2.4 GHz, 36 for 5 GHz</p>  |
| INNER_AUTH | <p>For PEAP, TTLS, or EAP-FAST security, allows you to select the password credentials (protocol) or your token card ID for authentication:</p> <ul style="list-style-type: none"> <li>• MSCHAPv2 (default)</li> <li>• PAP (TTLS only)</li> <li>• EAP/MSCHAPv2</li> <li>• EAP/MD5</li> <li>• EAP/GTC</li> <li>• EAP/TLS</li> </ul> | <p>For LEAP, PEAP, TTLS, or EAP-FAST security, allows you to select the password credentials (protocol) or your token card ID for authentication:</p> <ul style="list-style-type: none"> <li>• MSCHAPv2 (default, automatically set when EAP_TYPE is set to TTLS)</li> <li>• EAP/MSCHAPv2 (automatically set when EAP_TYPE is set to PEAP)</li> <li>• PAP (TTLS only)</li> </ul> |

**Differences in Wireless Communications Settings (continued)**

| Setting | Current Radio   | New Radio  |
|---------|---|--|
| SSID    | <p>Specifies the name of the wireless network.</p> <p>Default: INTERMEC</p>   | <p>Specifies the name of the wireless network.</p> <p>When MODE is set to DIRECT, the SSID is prefixed with “DIRECT-xy” where xy are alphanumeric characters randomly generated by the Wi-Fi radio.</p> <p>Default: INTERMEC</p>   |
| MODE    | <p>Specifies how the printer communicates with other devices:</p> <ul style="list-style-type: none"> <li>• Infrastructure (default): Devices on the network communicate with each other through access points. So, wireless and wired devices can communicate with each other.</li> <li>• Adhoc: Devices on the network communicate without using access points. Ad hoc mode is useful for establishing a network where wireless infrastructure does not exist or where services are not required.</li> </ul> | <p>Specifies how the printer communicates with other devices:</p> <ul style="list-style-type: none"> <li>• INFRA (default): Devices on the network communicate with each other through access points. So, wireless and wired devices can communicate with each other.</li> <li>• DIRECT: Uses the Wi-Fi Direct® standard to establish peer-to-peer connections without the need for an access point: <ul style="list-style-type: none"> <li>• The printer becomes a Wi-Fi Direct Group Owner. The SSID is used to create a device name and postfix so that the print can be seen by both Wi-Fi Direct devices, as well as non Wi-Fi Direct devices.</li> <li>• When you select DIRECT; WEP and WPA are disabled, WPA2 is enabled, and EAP_TYPE is set to OFF (clears any EAP_TYPE setting).</li> </ul> </li> </ul> |

**Differences in Wireless Communications Settings (continued)**

| <b>Setting</b>               | <b>Current Radio</b>   | <b>New Radio</b>  |
|------------------------------|--|---|
| EAP_TYPE                     | <p>Sets the type of 802.11 network authentication on the printer:</p> <ul style="list-style-type: none"> <li>• None</li> <li>• WEP</li> <li>• Pre-Shared Key</li> <li>• PEAP</li> <li>• TLS</li> <li>• TTLS</li> <li>• LEAP</li> <li>• EAP-FAST</li> </ul> | <p>Sets the type of 802.1x network authentication on the printer:</p> <ul style="list-style-type: none"> <li>• OFF (default)</li> <li>• PEAP</li> <li>• TTLS</li> <li>• LEAP</li> <li>• EAP-FAST</li> <li>• EAP-TLS</li> </ul>  |
| .SERVER_CN1                  | <p>When SECURITY TYPE is set to TTLS or PEAP, specifies the name of the certificate on the primary authentication server. If .SERVER_CN1 is not set, .SERVER_CN2 is used. If .SERVER_CN2 is also not set, any common name is accepted.</p>                 | Not Supported   |
| .SERVER_CN2                  | <p>When SECURITY TYPE is set to TTLS or PEAP, specifies the name of the certificate on the primary authentication server.</p>  | Not Supported   |
| TTLS_USER                    | <p>When SECURITY TYPE is set to TTLS, sets the TTLS out name.</p>  | Not Supported   |
| WPA, WPA2, or WPA/WPA2_MIXED | <p>WPA enables the WPA security mode, and WPA2 enables the WPA2 security mode.</p>   | <p>WPA enables the WPA security mode, and WPA2 enables the WPA2 security mode.</p> <p>WPA/WPA2_MIXED enables mixed WPA/WPA2 security mode, so the printer can connect to the access point in either WPA mode or WPA2 mode. This mode is backward compatible with WPA.</p> |



# Accessories

You can use these accessories with the printer. To order accessories, contact your local Intermec sales representative.

## **AB27 Battery**

Use the 7.4 V 2300 mAh lithium-ion battery to provide power to the printer.

## **Power Supply (Model AE19)**

Provides power to the printer and the 4-bay battery charger (Model AC18).

## **AC18 4-Bay Battery Charger**

Use the AC18 to charge up to four batteries at a time. The battery charger is designed to sense when a battery is fully charged and not overcharge it, ensuring long and consistent battery life.

## **AV14 Vehicle Dock**

Use the vehicle dock to attach the printer to a truck.

## **Cart Mount**

Stands the printer vertically when placed on a flat surface. Excellent for cart or desktop use.

## **Belt Clip**

Use the printer belt clip to attach the printer to your belt.

## **Handstrap**

Use the printer handstrap to conveniently carry your printer. With the handstrap attached, you can also attach the shoulder strap.

## **Media**

You can use tag, label, or receipt media with the printer. Printer media does not ship in the box with the printer but may be purchased from [www.intermec.com](http://www.intermec.com).

## **Media Core**

Use the media core to hold the media in place. The 0.75 inch media core ships with the printer. You can also order the 0.4 inch media core separately.

**Intermec Cleaning Swab**

Use the Intermec cleaning swab (P/N AE26034) to clean the printhead and platen roller. One cleaning swab is included with the printer. You can purchase additional cleaning swabs from [www.intermec.com](http://www.intermec.com).

**Cleaning Pen**

Use the cleaning pen (P/N 757150) to clean the printhead.

**Protective Case**

Use the protective case to transport and store your printer. The protective case keeps the printer free of dust, dirt, and moisture and still provides easy access to the printer for printing.

**Shoulder Strap**

Use the shoulder strap in combination with the handstrap to easily carry the printer. The wide padded strap makes it comfortable to wear the printer for long periods of time

**Serial Cable**

The serial adapter is an 8-pin DIN to DB9 connector that connects from the printer to your desktop PC.

# B

## Default Settings

# Factory Default Settings (Fingerprint Printers)

## *Factory Default Settings for Fingerprint Printers*

| Setting               | Default Value         |
|-----------------------|-----------------------|
| Xstart                | 0                     |
| Display               |                       |
| Orientation           | Normal                |
| Contrast              | Medium                |
| Media                 |                       |
| Width                 | Printhead width       |
| Length                | 1200                  |
| Test feed mode        | Fast                  |
| Type                  | Variable length strip |
| Contrast              | 0%                    |
| Xstart                | 0                     |
| Label constant        | 80                    |
| Label factor          | 40                    |
| Print definitions     |                       |
| Clip default          | Off                   |
| Print speed           | 75 mm/s               |
| Feed adjust           |                       |
| Start adjust          | 0                     |
| Stop adjust           | 0                     |
| Power                 |                       |
| Low battery indicator | 7.4 V                 |
| Sleep timer           | 20 sec                |
| Standby timer         | 30 min                |

**Factory Default Settings for Fingerprint Printers (continued)**

| Setting         | Default Value   |
|-----------------|-----------------|
| Bluetooth       |                 |
| Discoverable    | Enable          |
| Connectable     | Enable          |
| Encryption      | Disable         |
| Authentication  | Disable         |
| Reserve printer | Disable         |
| Device name     | 1-16 characters |
| Passcode        | 1234            |

**Factory Default Settings (IPL Printers)****Factory Default Settings for IPL Printers**

| Setting                     | Default Value |
|-----------------------------|---------------|
| Auto detect printer         | Enable        |
| Display                     |               |
| Orientation                 | Normal        |
| Contrast                    | Medium        |
| Print engine emulation mode | None          |
| Media                       |               |
| Form adjust dots X          | 0             |
| Form adjust dots Y          | 0             |
| Test feed mode              | Fast          |
| Media type                  | Continuous    |
| Darkness                    | 0             |
| Sensitivity                 | 180           |
| Print speed                 | 3 ips         |
| Power                       |               |
| Low battery indicator       | 7.4 V         |
| Sleep timer                 | 20 sec        |
| Standby timer               | 30 min        |

**Factory Default Settings for IPL Printers (continued)**

| <b>Setting</b>  | <b>Default Value</b> |
|-----------------|----------------------|
| Ser-Com         |                      |
| Baud rate       | 115200               |
| Data bits       | 8                    |
| Parity          | None                 |
| Stop bits       | 1                    |
| Protocol        | XON/XOFF             |
| Network         |                      |
| IP selection    | DHCP and BOOTP       |
| IP address      | 0.0.0.0              |
| Netmask         | 0.0.0.0              |
| Default router  | 0.0.0.0              |
| Name server     | 0.0.0.0              |
| MAC address     | Unique               |
| Bluetooth       |                      |
| Discoverable    | Enable               |
| Connectable     | Enable               |
| Encryption      | Disable              |
| Authentication  | Disable              |
| Reserve printer | Disable              |
| Device name     | 1-16 characters      |
| Passcode        | 1234                 |

# Factory Default Settings (ESC/P Printers)

## Factory Default Settings for ESC/P Printers

| Setting               | Default Value   |
|-----------------------|-----------------|
| Auto detect printer   | Enable          |
| Media dark adjust     | 100             |
| Print speed           | 75 mm/s         |
| Power                 |                 |
| Low battery indicator | 7.4 V           |
| Sleep timer           | 20 sec          |
| Standby timer         | 30 min          |
| Bluetooth             |                 |
| Discoverable          | Enable          |
| Connectable           | Enable          |
| Encryption            | Disable         |
| Authentication        | Disable         |
| Reserve printer       | Disable         |
| Device name           | 1-16 characters |
| Passcode              | 1234            |
| Serial-Com            |                 |
| Baud rate             | 115200          |
| Data bits             | 8               |
| Parity                | None            |
| Stop bits             | 1               |
| Protocol              | XON/XOFF        |
| Network               |                 |
| IP selection          | DHCP and BOOTP  |
| IP address            | 0.0.0.0         |
| Netmask               | 0.0.0.0         |
| Default router        | 0.0.0.0         |
| Name server           | 0.0.0.0         |
| MAC address           | Unique          |

***Appendix B – Default Settings***



# C

## IPL and Fingerprint Setup Menus

# IPL Setup Menu

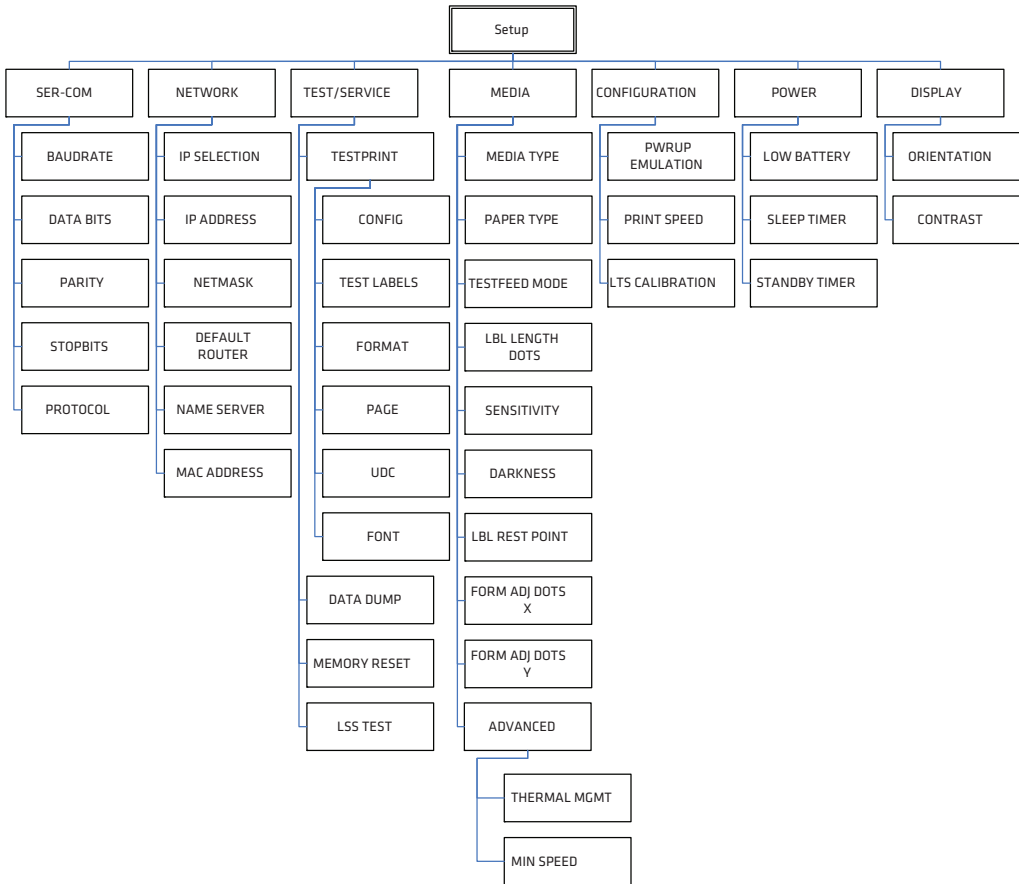

# Fingerprint Setup Menu

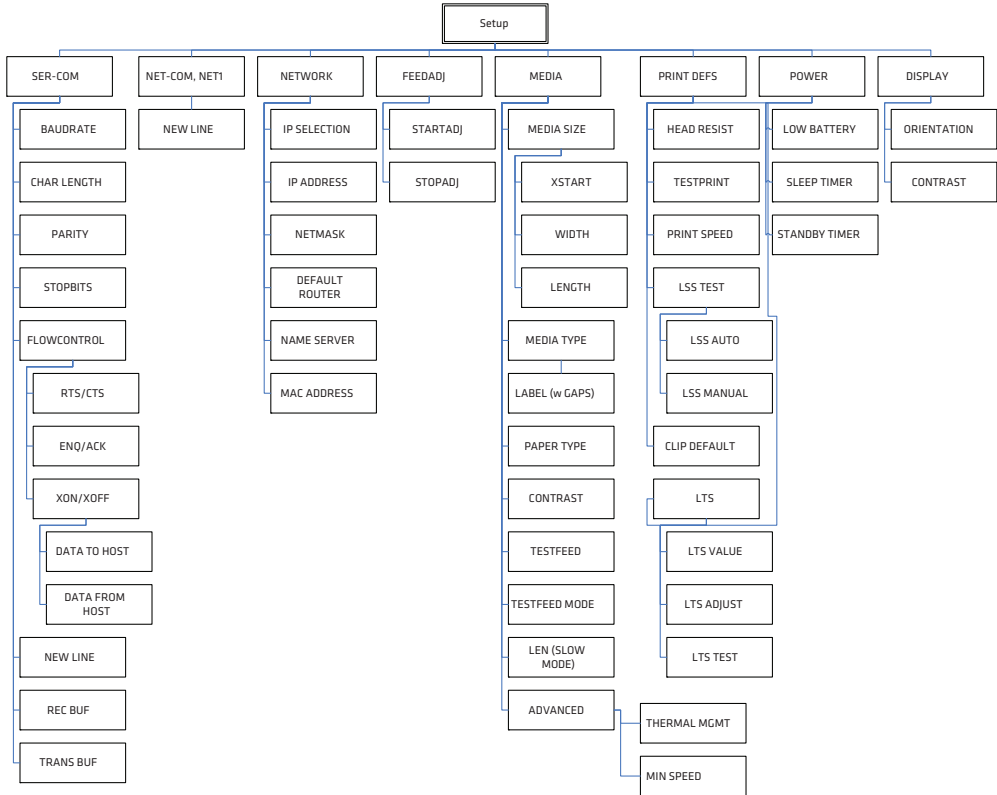

***Appendix C – IPL and Fingerprint Setup Menus***



# Index

**Numerics**

- 802.11
  - determining which radio is installed 35
  - setting up communications 35
  - wireless communications settings, differences 68

**A**

- AB27 battery 71
- AC18 battery charger 13, 71
- accessories
  - AB27 battery 71
  - AC18 battery charger 71
  - AV14 vehicle dock 71
  - belt clip 71
  - cart mount 71
  - handstrap 71
  - power supply 71
  - serial cable 72
  - shoulder strap 72
- AV14 vehicle dock 71

**B**

- backlight, understanding 10
- batteries
  - AC18 charger 13
  - charging 13
  - charging time 11
  - extending life 14
  - installing 11, 12
  - status icons 13
  - using 11
- Bluetooth communications 33
- button functions 4

**C**

- cleaning the printer 56
- cold boot 56
- communication problems 54
  - using Dump mode in IPL 55
  - using the line analyzer in Fingerprint 54
- communications
  - setting up 802.11 radio communications 35
  - setting up Bluetooth radio communications 33

- configuration settings
  - changing from printer home page 37
  - changing using the command line 37
  - changing with PrintSet 37
  - changing with SmartSystems 38, 43
  - display modes 20
- configuring, overview 36
- connecting to the printer using USB 30
- control panel features 4

**D**

- default settings
  - ESC/P printers 77
  - Fingerprint printers 74
  - IPL printers 75
- display modes
  - error 23
  - information 20
  - pause 21
  - ready 20
  - setup 21
  - test 23
- downloading fonts and graphics 47

**E**

- error messages and icons
  - door open 52
  - field out of label 51
  - IP configuration error 51
  - IP link error 51
  - LSS too high/low 51
  - out of paper 51
  - pause 51
  - printead hot 51
  - upgrading 51
- Error mode 23
- ESC/P
  - change printer language 8
  - default settings 77
  - setup commands 26

**F**

- Fingerprint
  - change printer language 7
  - default settings 74
  - setup menu 25, 81
- firmware upgrade, cold booting 56

- H**  
HyperTerminal  
    upgrade firmware using 43  
    view IPL commands 37  
HyperTerminal, sending printer commands 37
- I**  
Information mode 20  
IPL  
    change printer language 8  
    default settings 75  
    setup commands 26  
    setup menu 80  
    view commands as you type 37
- L**  
language, see printer language  
load media 15
- M**  
media  
    loading 15  
    recommended sensitivity and constant 65  
    supported 64  
media specifications 63
- P**  
Pause mode 21  
power specifications 62  
print speed and resolution 63  
printer  
    backlight 10  
    charging batteries 13  
    cleaning 56  
    cold boot 56  
    communication problems 54  
    configuring 36  
    control panel 4  
    default settings 74  
    downloading fonts and graphics 47  
    features 2  
    home page 37  
    languages, choosing 6  
    loading media 15  
    memory 63  
    parts 2  
    printing a test page 27  
    Ready-to-Work indicator 6  
    soft keys 5  
    sounds, understanding 10  
    troubleshooting problems 52  
    using the batteries 11  
    using the buttons 4  
printer language  
    change using ESC/P 8  
    change using Fingerprint 7  
    change using IPL 8  
    change using PrintSet 7  
PrintSet  
    change printer language 7  
    changing configuration settings 37  
    downloading fonts and graphics 47  
    upgrade firmware using 40
- R**  
Ready mode 20  
Ready-to-Work indicator states 6
- S**  
setup commands  
    ESC/P 26  
    IPL 26  
setup menu  
    Fingerprint 25, 81  
    IPL 80  
Setup mode 21  
SmartSystems, changing configuration settings 38, 43  
soft keys, using 5  
sounds, status 10  
specifications  
    external fanfold media 64  
    media 63  
    memory 63  
    power 62  
    print speed and resolution 63  
    print technology 63  
    supported media 64  
    temperature and humidity 62
- T**  
temperature and humidity specifications 62  
Test mode 23  
test page, printing 27

## **Index**

troubleshooting  
    communication problems 54  
    contacting product support 50  
    error messages 50  
    printer problems and  
        solutions 52  
    using Dump mode in IPL 55  
    using the line analyzer in  
        Fingerprint 54

## **U**

upgrading firmware  
    using HyperTerminal 43  
    using PrintSet 40  
USB, connecting to the printer 30

## **W**

wireless communications settings,  
    differences 68







16201 25th Avenue West  
Lynnwood, Washington 98087  
U.S.A.

tel 425.921.4290  
[www.honeywellaidc.com](http://www.honeywellaidc.com)

## PB22 and PB32 Mobile Label and Receipt Printer User Guide



P/N 934-046-006

## Free Manuals Download Website

<http://myh66.com>

<http://usermanuals.us>

<http://www.somanuals.com>

<http://www.4manuals.cc>

<http://www.manual-lib.com>

<http://www.404manual.com>

<http://www.luxmanual.com>

<http://aubethermostatmanual.com>

Golf course search by state

<http://golfingnear.com>

Email search by domain

<http://emailbydomain.com>

Auto manuals search

<http://auto.somanuals.com>

TV manuals search

<http://tv.somanuals.com>