

Honeywell

APT2000 Series 2-Wire Contacting Conductivity Transmitters User Manual

70-82-25-95
Revision 2 – 05/04



67077

Copyright and Notices

© Copyright 2004 by Honeywell
Revision 2 – 01/04

Warranty/Remedy

Honeywell warrants goods of its manufacture as being free of defective materials and faulty workmanship. Contact your local sales office for warranty information. If warranted goods are returned to Honeywell during the period of coverage, Honeywell will repair or replace without charge those items it finds defective. The foregoing is Buyers' sole remedy and is **in lieu of all other warranties, expressed or implied, including those of merchantability and fitness for a particular**

purpose. Specifications may change without notice.

The information we supply is believed to be accurate and reliable as of this printing. However, we assume no responsibility for this use.

While we provide application assistance personally, through our literature and the Honeywell web site, it is up to the customer to determine the suitability of the product in the application.

About This Document

Abstract

This document provides information specific to the APT2000CC Transmitter.

Contacts

World Wide Web

The following lists Honeywell's World Wide Web sites that will be of interest to our customers.

Honeywell Organization

WWW Address (URL)

Corporate

<http://www.honeywell.com>

Industrial Measurement and Control

<http://www.honeywell.com/imc>

Telephone

Contact us by telephone at the numbers listed below.

Organization

Phone Number

United States and Canada

Honeywell

1-800-423-9883 Tech. Support

1-888-423-9883 Q&A Faxback
(TACFACS)

1-800-525-7439 Service

Address

Honeywell Industrial Measurement and Control, 1100 Virginia Drive,
Fort Washington, PA 19034

Safety information	5
Intended use	7
Trademarks	7
Certificates	8
EC Declaration of Conformity	8
Conformity with FDA 21 CFR Part 11	9
EC-Type-Examination Certificate	10
Overview of APT2000CC	13
Assembly	14
Packing list	14
Mounting plan	15
Pipe mounting, panel mounting	16
Installation and connection	18
Information on installation	18
Terminal assignments	19
Cable preparation	20
Wiring example	23
User interface and display	24
Operation: Keypad	26
Safety features	27
Sensocheck, Sensoface sensor monitoring	27
GainCheck device self test	27
Automatic device self-test	27
Hold mode	28
Output	29
(Loop current, HART communication, Alarm)	29
Configuration	30
Menu structure of configuration	31
Overview of configuration steps	32
Individual settings (for copy)	33
Current output	34
Temperature compensation	48
Alarm settings	50

Contents

Passcodes according to FDA 21 CFR Part 1152
Calibration54
Calibration by input of cell constant	56
Calibration with calibration solution	58
Product calibration	60
Temp probe adjustment	62
Measurement62
Diagnostics functions63
Display of output currents	63
Display of calibration data (Cal nfo)	63
Sensor monitor	63
Display of last error message	63
Specify output current	64
Cleaning64
Operating states65
Error messages (error codes)66
Sensoface68
USP function70
Appendix73
Product line and accessories	73
Specifications	74
Calibration solutions	78
Concentration curves	80
Division 2 wiring	85
FM Control Drawing	86
Glossary88
Index90

Safety information

Be sure to read and observe the following instructions!

The device has been designed in accordance with the state of the art and complying with the applicable safety regulations. When operating the device, certain conditions may nevertheless lead to danger for the operator or damage to the device.

Caution!

Commissioning may only be carried out by trained experts. Whenever it is likely that protection has been impaired, the device shall be made inoperative and secured against unintended operation.

The protection is likely to be impaired if, for example:

- the device shows visible damage
- the device fails to perform the intended measurements
- after prolonged storage at temperatures above 70 °C
- after severe transport stresses

Before recommissioning the device, a professional routine test in accordance with EN 61010-1 must be performed. This test should be carried out by the manufacturer.

Caution!

Before commissioning it must be proved that the device may be connected with other equipment.

The Transmitter shall not be used in a manner not specified by this manual.

Safety information

Safety precautions for installation

- Be sure to observe the stipulations of EN 60079-10 / EN 60079-14 during installation.
- The **APT2000CC-H-00 Transmitter** is approved for operation in safe locations and in DIV 2 hazardous locations (USA/Canada only).
- The **APT2000CC-H-IS Transmitter** is approved for operation in hazardous locations DIV 1 (USA/Canada) / Zone 1 (Europe).
The measuring inputs of the APT2000CC-H-IS Transmitter may be led into Zone 0 (Europe).
However, be sure to observe the national regulations concerning Zone 0 applications. The Transmitter itself is not approved for operation in Zone 0!

Connection to supply units

- **APT2000CC-H-00**: Before connecting this Transmitter to a supply unit, make sure that its output voltage cannot exceed 30 V DC.
Do not use alternating current or mains power supply!
- **APT2000CC-H-IS**: This Transmitter may only be connected to an explosion-proof power supply unit (for input ratings refer to annex of EC-Type-Examination Certificate). Before commissioning it must be made sure that the connections to other equipment such as power supply unit and cables are intrinsically safe.

Note for cleaning in a hazardous location

To protect against electrostatic discharge, the device may only be cleaned with a damp cloth in hazardous locations.

Intended use

The APT2000CC is used for measurement of electrical conductivity and temperature in liquids. Fields of application are: biotechnology, chemical industry, environment, food processing, water/waste-water treatment.

The rugged molded enclosure can be fixed into a control panel or mounted on a wall or at a post.

The protective hood provides additional protection against direct weather exposure and mechanical damage.

The Transmitter has been designed for Honeywell 2-electrode sensors.

- Never use the **APT2000CC-H-00** for measurements in hazardous locations.
- The **APT2000CC-H-IS** is approved for operation in hazardous locations.

Trademarks

The following names are registered trademarks. For practical reasons they are shown without trademark symbol in this manual.

HART® is a registered trademark of the HART Communication Foundation.

Sensocheck
Sensoface
GainCheck

EC DECLARATION OF CONFORMITY

The following product,

APT 2000 CC Transmitter

is in compliance with the provisions of the following EC Directives and/or standards.

Low Voltage Directive:	73/23/EEC
Standard:	EN 61010-1 / VDE 0411 Teil 1: 2002-08
EMC Directive:	89/336/EEC
Standard:	DIN EN 61326 / VDE 0843 Teil 20: 2002-03
Explosion protection :	94/9/EG
Standard :	EN 50014 : 1997 EN 50020 : 1994

Furthermore it complies with the provisions of the German law on electromagnetic compatibility of devices (EMVG) of September 18, 1998.

Manufacturer: Honeywell International, Inc.
525 East Market Street
York, PA 17405 USA

The authorized signatory to this declaration, on behalf of the manufacturer, and the Responsible Person based within the EU, is identified below.

Honeywell IM&C
1100 Virginia Drive
Fort Washington, PA 19034

Sam Arcara
Director

Industrial Measurement & Control Engineering

Issue Date: 18 Oct. 20 04

Conformity with FDA 21 CFR Part 11

In their directive “Title 21 Code of Federal Regulations, 21 CFR Part 11, Electronic Records; Electronic Signatures” the US American health agency FDA (Food and Drug Administration) regulates the production and processing of electronic documents for pharmaceutical development and production. This results in requirements for measuring devices used for corresponding applications. The following features ensure that the measuring devices of the APT2000CC Series meet the demands of FDA 21 CFR Part 11:

Electronic Signature

Access to the device functions is regulated and limited by individually adjustable codes – “Passcodes” (for Passcode Editor see Page 52, overview of factory settings on back of manual). This prevents unauthorized modification of device settings or manipulation of the measurement results. Appropriate use of these passcodes makes them suitable as electronic signature.

Audit Trail

Every (manual) change of device settings can be automatically documented. For that purpose, each change is marked by a “Configuration Change Flag”, which can be interrogated and documented via HART communication. Then the changed device settings/parameters can also be retrieved and documented via HART communication.

EC-Type-Examination Certificate



Translation

EC-TYPE EXAMINATION CERTIFICATE

(1)

- (2) Equipment or Protective System intended for use in potentially explosive atmospheres - **Directive 94/9/EC**
- (3) EC-Type Examination Certificate Number



TÜV 99 ATEX 1500

- (4) Equipment or Protective System: Analytical process transmitter Typ APT2000CC-*-IS
- (5) Manufacturer: Honeywell Inc.
- (6) Address: USA - Fort Washington PA 19034, 1100 Virginia Drive
- (7) This equipment or protective system and any acceptable variation thereto is specified in the schedule to this certificate and the documents therein referred to.
- (8) The TÜV Hannover/Sachsen-Anhalt e.V., TÜV Certification Body N° 0032 in accordance with Article 9 of the Council Directive 94/9/EC of March 23, 1994, certifies that this equipment or protective system has been found to comply with the Essential Health and Safety Requirements relating to the design and construction of equipment and protective systems intended for use in potentially explosive atmospheres given in Annex II to the Directive.
- The examination and test results are recorded in confidential report N° 99/PX25990.
- (9) Compliance with the Essential Health and Safety Requirements has been assured by compliance with:

EN 50 014:1997

EN 50 020:1994

- (10) If the sign "X" is placed after the certification number, it indicates that the equipment or protective system is subject to special conditions for safe use specified in the schedule to this certificate.
- (11) This EC-TYPE EXAMINATION CERTIFICATE relates only to the design and construction of the specified equipment or protective system. If applicable, further requirements of this Directive apply to the manufacture and supply of this equipment or protective system.
- (12) The marking of the equipment or protective system shall include the following:

II 2 (1) G EEx Ib [Ia] IIC T6

Hannover, 1999-11-17

TÜV Hannover/Sachsen-Anhalt e.V.
TÜV CERT-Zertifizierungsstelle
Am TÜV 1
D-30519 Hannover

Head of the
Certification Body



0102700100 1/39

This certificate may only be reproduced without any change, schedule included.
Excerpts or changes shall be allowed by the TÜV Hannover/Sachsen-Anhalt e.V.

page 1/3



(13)

SCHEDULE

(14) **EC-TYPE EXAMINATION CERTIFICATE N° TÜV 99 ATEX 1500**

(15) Description of equipment or protective system

The Analytical process transmitter Typ APT2000CC--IS is used for the recognition and processing of electrochemical quantities.

The maximum permissible ambient temperature is 55°C.

Electrical data

Current loop.....in type of protection "Intrinsic Safety" EEx Ib IIC
(terminals 10, 11) only for the connection to a certified intrinsically safe circuit
with the following maximum values:
 $U_i = 30 \text{ V}$
 $I_i = 100 \text{ mA}$
 $P_i = 0.8 \text{ W}$
 effective internal capacitance $C_i = 20 \text{ nF}$
 effective internal inductance $L_i = 0.2 \text{ mH}$

Conductivity measuring loop.....in type of protection "Intrinsic Safety" EEx ia IIC
(terminals 1, 2, 3, 4, 5) Maximum values:
 $U_o = 10 \text{ V}$
 $I_o = 145 \text{ mA}$
 $P_o = 145 \text{ mW}$
 $R_i = 34.5 \text{ } \Omega$
 Characteristic: linear
 effective internal capacitance $C_i = 5 \text{ nF}$
 The effective internal inductance is negligibly small.
 max. permissible external capacitance $C_o = 3 \text{ } \mu\text{F}$
 max. permissible external inductance $L_o = 1 \text{ mH}$

Temperature measuring loop....in type of protection "Intrinsic Safety" EEx ia IIC
(terminals 7, 8) Maximum values:
 $U_o = 5 \text{ V}$
 $I_o = 3.5 \text{ mA}$
 $P_o = 5 \text{ mW}$
 $R_i = 1590 \text{ } \Omega$
 Characteristic: linear
 effective internal capacitance $C_i = 250 \text{ nF}$
 The effective internal inductance is negligibly small.
 max. permissible external capacitance $C_o = 100 \text{ } \mu\text{F}$
 max. permissible external inductance $L_o = 1 \text{ H}$



EP for the connection to the equipotential bonding system
(Terminal 9)

The current loop is safely separated from the conductivity measuring loop and the temperature measuring loop up to a voltage of 60 V. The conductivity measuring loop and the temperature measuring loop are galvanically connected.

(16) Test documents are listed in the test report No. 99/PX25990.

(17) Special condition for safe use
none.

(18) Essential Health and Safety Requirements
no additional ones

Overview of APT2000CC

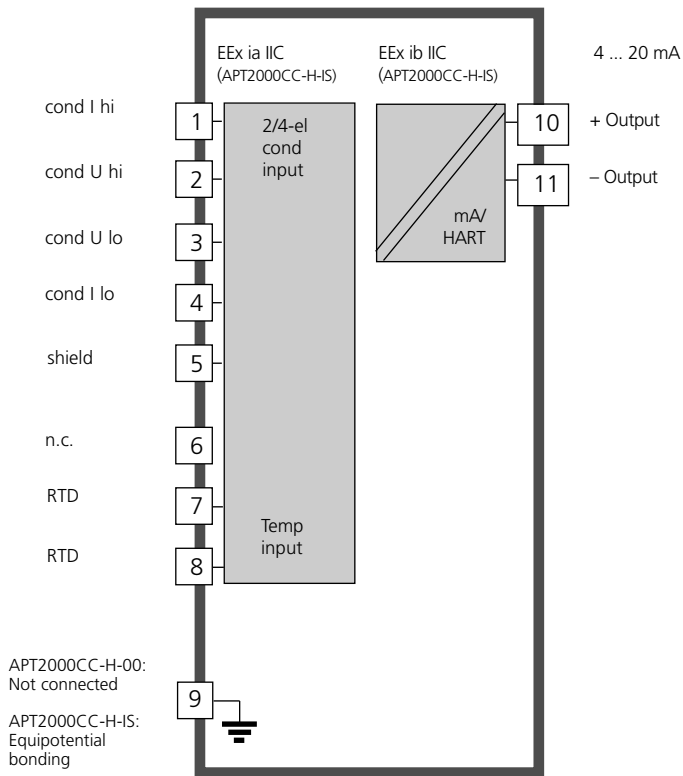

Assembly

Packing list

Check the shipment for transport damage and completeness. The package should contain:

- Front unit of APT2000CC
- Lower case
- Bag containing small parts
- Instruction manual
- Specific test report

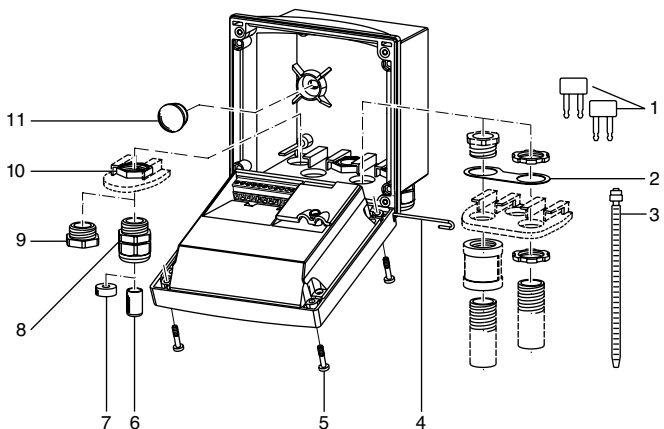

- | | |
|--|---|
| 1 Jumper (2 piece) | 6 Sealing inserts (1 piece) |
| 2 Washer (1 piece), for conduit mounting: place washer between enclosure and nut | 7 Rubber reducer (1 piece) |
| 3 Cable ties (3 pieces) | 8 Cable glands (3 pieces) |
| 4 Hinge pin (1 piece), insertable from either side | 9 Filler plugs (3 pieces) |
| 5 Enclosure screws (4 pieces) | 10 Hexagon nuts (5 pieces) |
| | 11 Sealing plugs (2 pieces), for sealing in case of wall mounting |

Fig. 1: Assembling the enclosure

Mounting plan

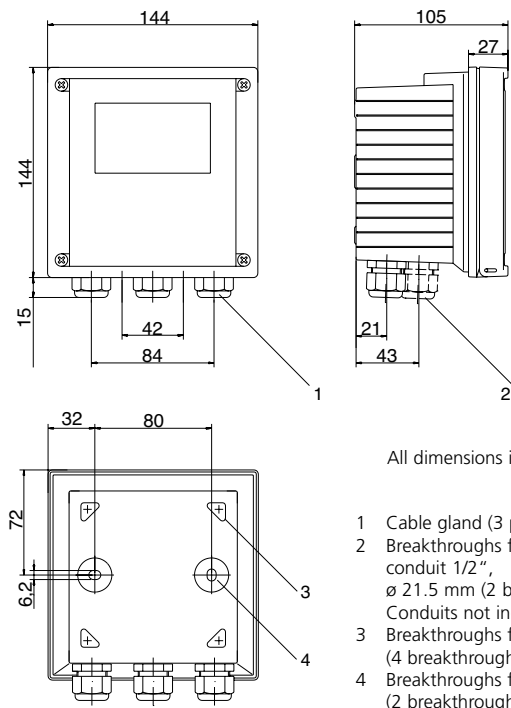
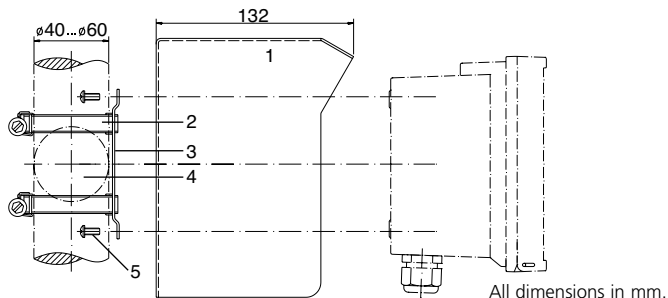

Fig. 2: Mounting plan

Pipe mounting, panel mounting



- 1 51205989-001 protective hood (if required)
- 2 Hose clamps with worm gear drive to DIN 3017 (2 pieces)
- 3 Pipe-mount plate (1 piece)
- 4 For vertical or horizontal posts or pipes
- 5 Self-tapping screws (4 pieces)

Fig. 3: 51205988-001 pipe-mount kit

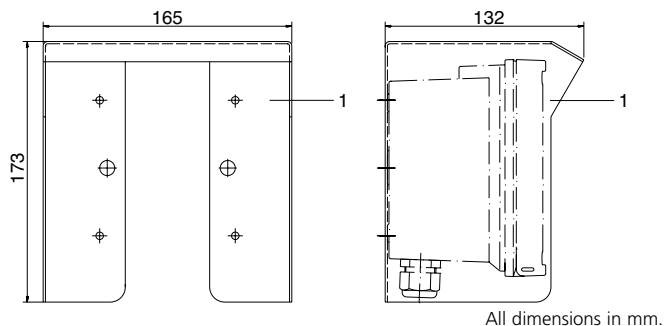
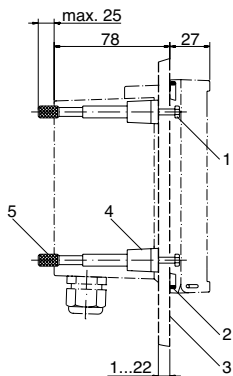

Fig. 4: 51205989-001 protective hood for wall and pipe mounting



- 1 Screws (4 pieces)
- 2 Gasket (1 piece)
- 3 Panel
- 4 Span pieces (4 pieces)
- 5 Threaded sleeves (4 pieces)

Panel cutout 138 x 138 mm
(DIN 43700)

All dimensions in mm.

Fig. 5: 51205990-001 panel-mount kit

Installation and connection

Information on installation

- Installation may only be carried out by trained experts in accordance with this instruction manual and as per applicable local and national codes.
- Be sure to observe the technical specifications and input ratings.
- Be sure not to notch the conductor when stripping the insulation.
- When commissioning, a complete configuration must be carried out by the system administrator.

Connection to supply units

- **APT2000CC-H-00**: Before connecting this device to a supply unit, make sure that its output voltage cannot exceed 30 V DC. Do not use alternating current or mains power supply!
- **APT2000CC-H-IS**: This device may only be connected to an explosion-proof power supply unit (for input ratings refer to annex of EC-Type-Examination Certificate).

Division 2 wiring



The connections to the Transmitter must be installed in accordance with the National Electric Code (ANSI-NFPA 70) Division 2 hazardous (classified) location non-incendive wiring techniques.

Terminal assignments

Terminals: suitable for single wires/flexible leads up to 2.5 mm² (AWG 14).

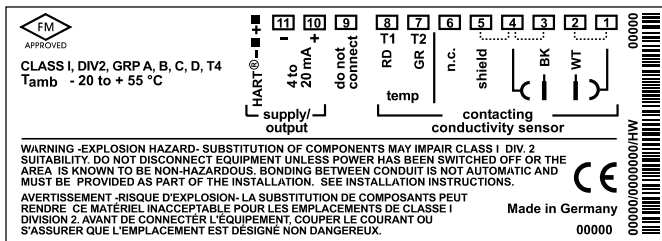

Fig. 6: Terminal assignments of APT2000CC-H-00 Transmitter Class 1, Div 2, Group A, B, C, D, T4

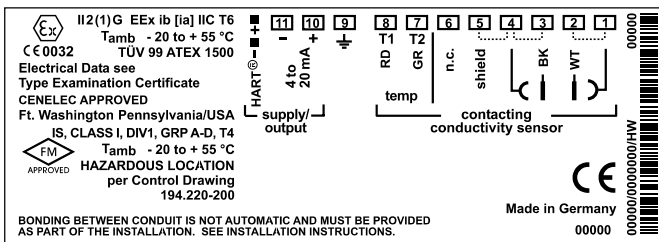

Fig. 7: Terminal assignments of APT2000CC-H-IS Transmitter IS, Class I, Div 1, Group A, B, C, D, T4 II 2(1) G EEx ib [ia] IIC T6

Cable preparation

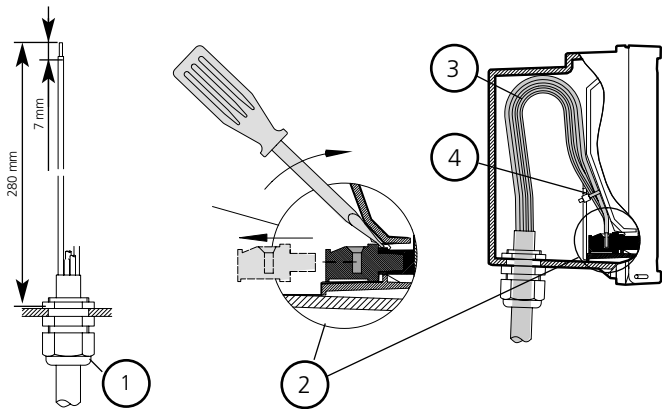

Fig. 8: Information on installation, cable preparation

- 1** Recommended stripping lengths for multi-core cables
- 2** Pulling out the terminals using a screwdriver (also see **6**)
- 3** Cable laying in the Transmitter
- 4** Connecting lines for loop current

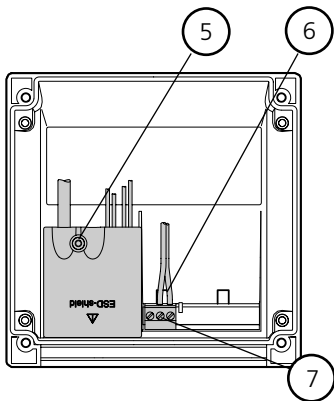

Fig. 8a: Information on installation, rear side of Transmitter

- 5** Cover for sensor and temperature probe terminals
- 6** Area for placing the screw-driver to pull out the terminals
- 7** Connection of handheld terminal

APT2000CC

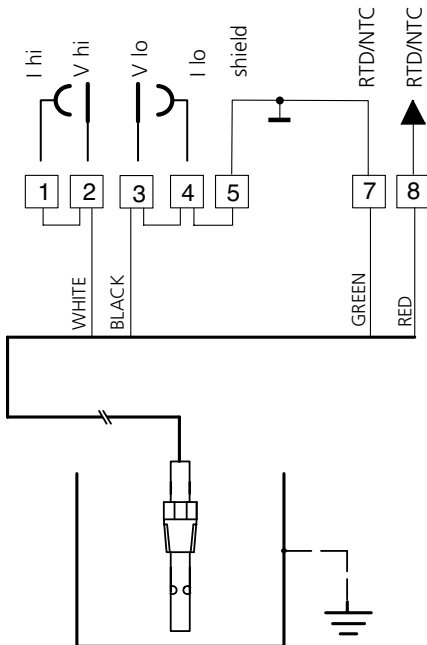

Fig. 9: Conductivity measurement with Honeywell 2-electrode sensors

Caution! Place jumpers: across terminals 1 and 2
across terminals 3 and 4
across terminals 4 and 5

User interface and display

User interface

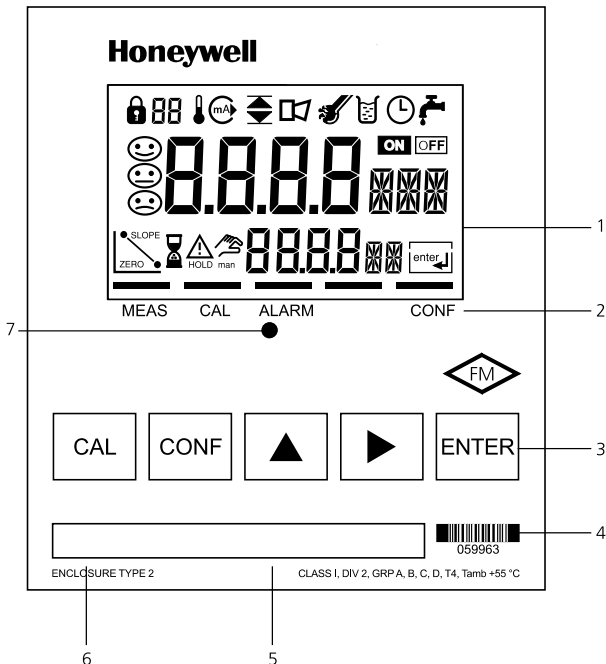

Fig. 10: Front view of Transmitter

- | | | | |
|---|---|---|-------------------|
| 1 | Display | 3 | Keypad |
| 2 | Mode indicators (no keys),
from left to right: | 4 | Coding |
| | - Measuring mode | 5 | Rating plate |
| | - Calibration mode | 6 | Model designation |
| | - Alarm | 7 | Alarm LED |
| | - Wash contact (APT4000CC only) | | |
| | - Configuration mode | | |

Display

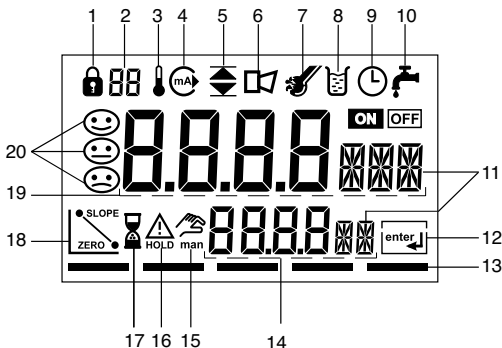













Fig. 11: Display of Transmitter

- | | | | |
|----|--|----|---------------------------|
| 1 | Passcode entry | 14 | Lower display |
| 2 | Display of measured variable* | 15 | Manual temp specification |
| 3 | Temperature | 16 | Hold mode active |
| 4 | Current output | 17 | Waiting time running |
| 5 | Limit values | 18 | Electrode data |
| 6 | Alarm | 19 | Main display |
| 7 | Sensocheck | 20 | Sensoface |
| 8 | Calibration | | |
| 9 | Interval/response time | | |
| 10 | Wash contact* | | |
| 11 | Measurement symbol | | |
| 12 | Proceed with ENTER | | |
| 13 | Bar for identifying the device status, above mode indicators from left to right: | | |
| | - Measuring mode | | |
| | - Calibration mode | | |
| | - Alarm | | |
| | - Wash contact* (APT4000CC only) | | |
| | - Configuration mode | | |

* Not in use

Operation: Keypad

	Start, end calibration
	Start, end configuration
	Select digit position (selected position flashes)
	Edit digit
	<ul style="list-style-type: none">• Calibration: Continue in program sequence• Configuration: Confirm entries, next configuration step• Measuring mode: Display output current
 ➔ 	Cal Info, display of cell constant
 ➔ 	Error Info: Display of last error message
 + 	Start GainCheck device self-test

Safety functions

Sensocheck, Sensoface sensor monitoring



Sensocheck continuously monitors the sensor and lines. Sensocheck can be switched off (Configuration, Pg 51).



Sensoface provides information on the conductivity sensor condition. Significant sensor polarization effects or an excessive cable capacitance are indicated.

GainCheck device self test

A display test is carried out, the software version is displayed and the memory and measured value transfer are checked.

Start GainCheck device self-test:  + 

Automatic device self-test

The automatic device self-test checks the memory and measured-value transfer. It runs automatically in the background at fixed intervals.

Safety functions

Hold mode

Display: 

The Hold mode is a safety state during configuration and calibration. The loop current is frozen (Last) or set to a fixed value (Fix).

If the calibration or configuration mode is exited, the Transmitter remains in the Hold mode for safety reasons. This prevents undesirable reactions of the connected peripherals due to incorrect configuration or calibration. The measured value and "HOLD" are displayed alternately. The Transmitter only returns to measuring mode after **ENTER** is pressed and 20 seconds have passed.

Configuration mode is also exited automatically 20 minutes (timeout) after the last keystroke. The Transmitter returns to measuring mode.

Timeout is not active during calibration.

Behavior of output signal:

Last: The loop current is frozen at its last value.
Recommended during short configuration procedures.
The process should not change decisively during configuration. Changes are not noticed with this setting!

Fix: The loop current is set to a value that is noticeably different from the process value in order to signal the control system that the Transmitter is being worked at.

For configuration see Pg 47.

Outputs

Current output / Loop current

The loop current is controlled by the process variable selected in the configuration.

The current start and end can be set to represent any desired value. To check connected peripherals (e.g. limit switches, controllers), the loop current can be manually specified (see Pg 37).

HART communication

The APT2000CC-H-... Transmitter can be remote-controlled via HART communication. It can be configured using a handheld terminal or from the control room. Measured values, messages and device identification can be downloaded at any time. This allows easy integration also in fully automatic process cycles.

A list of the HART commands can be found in the "APT2000CC Transmitter-Specific Command Specification".
<http://content.honeywell.com/ipc/faq>

Alarm

The alarm delay is configurable.

Error messages can also be signaled by a 22 mA loop current (see Configuration, Pg 51).

The alarm LED on the front panel can be configured as follows:

HOLD off:	Alarm: LED flashing
HOLD on:	Alarm: LED on. HOLD: LED flashing.

Configuration

In the Configuration mode you set the device parameters.

Activate



Activate with **CONF**



Enter passcode "1200"
Edit parameter with **▶** and **▲**,
confirm/continue with **ENTER**.
(End with **CONF**, then **ENTER**.)

Hold

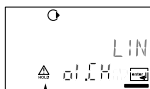

HOLD icon

During configuration the Transmitter remains in the Hold mode for reasons of safety. The loop current is frozen (at its last value or at a preset fixed value, depending on the configuration), Sensoface is off, mode indicator "Configuration" is on.

Input errors

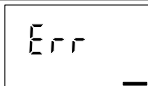

The configuration parameters are checked during the input. In the case of an incorrect input "Err" is displayed for approx. 3 s. The incorrect parameters cannot be stored. Input must be repeated.

End



End with **CONF**. The measured value and Hold are displayed alternately, "enter" flashes. End Hold mode with **ENTER**. The display shows the measured value. The output current remains frozen for another 20 s (HOLD icon on, "hourglass" flashes).

* Factory setting, for passcode editing see Pg 52

Menu structure of configuration

The configuration steps are assigned to different menu groups:

- Current output (code: o1.)
- Temperature compensation (code: tc.)
- Alarm settings (code: AL.)

With the arrow keys you can jump between the individual menu groups. Each menu group contains menu items for setting the parameters.

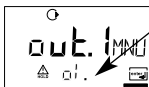

Example:

"o1." is displayed with all menu items of the "Current output" menu group.

Pressing **ENTER** accesses the submenus. The values are edited using the arrow keys. Pressing **ENTER** confirms/stores the settings.

Return to measurement: Press **CONF**. Press **ENTER** to confirm safety prompt. After 20 sec the Transmitter will be in measuring mode again.

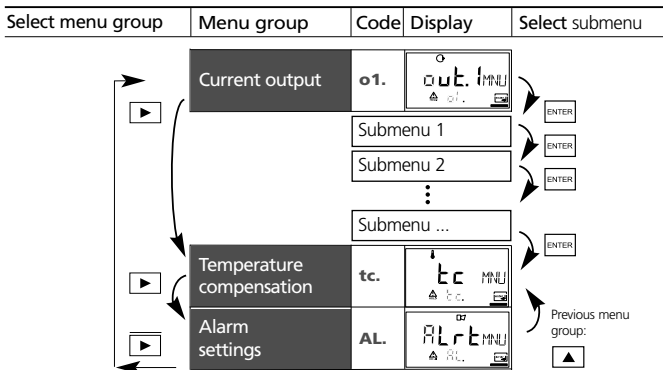

Overview of configuration steps

Code	Menu	Selection / Default										
out1	Current output	(Factory setting bold print)										
o1.CELL	Sensor selection	2-electrode , 4-electrode										
o1.UnIT	Select measured variable	μS , mS/cm , S/m, M Ω -cm, SAL, %, USP										
o1.CoNC	Select solution (Conc), see Pg 38 Codes:	<table border="1"> <tr> <td>NaCl</td> <td>HCl</td> <td>NaOH</td> <td>H₂SO₄</td> <td>HNO₃</td> </tr> <tr> <td>-01-</td> <td>-02-</td> <td>-03-</td> <td>-04-</td> <td>-05-</td> </tr> </table>	NaCl	HCl	NaOH	H ₂ SO ₄	HNO ₃	-01-	-02-	-03-	-04-	-05-
NaCl	HCl	NaOH	H ₂ SO ₄	HNO ₃								
-01-	-02-	-03-	-04-	-05-								
o1.CHAR	Characteristic linear / logarithmic (not for SAL, Conc, USP)	LIN / LOG										
o1.4mA	LIN: Enter current start	xxxx (000.0 mS)										
o1.20mA	Enter current end	xxxx (100.0 mS)										
o1.4mA	LOG: Enter current start	in decades: 0.001 ... 1000 mS (0.100 mS)										
o1.20mA	Enter current end	in decades: 0.001 ... 1000 mS (100.0 mS)										
o1.FtME	Time constant of output filter	xxxx SEC (0000 SEC)										
o1.FAIL	22 mA signal for error messages	ON / OFF										
o1.HoLD	Signal behavior during HOLD	Last / Fix										
o1.FIX	Fix: Enter fixed value	xxx.x mA (021.0 mA)										
tc	Temperature compensation											
tc.UnIT	Select temperature unit	$^{\circ}\text{C}$ / $^{\circ}\text{F}$										
tc.rTD	Select temperature probe	Pt100/Pt1000/NTC30/ NTC8.55										
tc.	Select temperature compensation (not for SAL)	OFF /LIN/NLF (natural waters)/ -01- FCT (NaCl traces) -02- FCT (HCl traces) -03- FCT (NH ₃ traces)										
tc.lin	Lin: Enter temperature coefficient	xx.xx %/K (02.00 %/K)										
ALrt	Alarm settings											
AL.SnSO	Select Sensocheck	ON / OFF										
AL.dLY	Enter alarm delay	0000 ... 0600 SEC (0010 SEC)										
AL.LED	LED in HOLD mode	ON / OFF										

Individual settings

(Original for copy)

Honeywell

Code	Parameter	Factory setting	Individual setting
o1.CELL	Sensor type	<u>2-EL</u>	_____
o1.UnIT	Measurement unit	<u>mS/cm</u>	_____
o1.CoNC	Concentration	<u>NaCl</u>	_____
o1.CHAR	Characteristic (LIN/LOG)	<u>LIN</u>	_____
o1.4mA	Current start	<u>000.0 mS</u>	_____
o1.20mA	Current end	<u>100.0 mS</u>	_____
o1.FtME	Filter time	<u>0000 SEC</u>	_____
o1.FAIL	22mA signal	<u>OFF</u>	_____
o1.HoLD	Hold behavior	<u>LAST</u>	_____
o1.FIX	Fix current	<u>021.0 mA</u>	_____
tc.UnIT	Unit °C / °F	<u>°C</u>	_____
tc.rTD	Temp probe	<u>NTC 8.55</u>	_____
tc.	Temperature compensation	<u>OFF</u>	_____
tc.LIN	TC process medium	<u>02.00 %/K</u>	_____
AL.SnSO	Sensocheck	<u>OFF</u>	_____
AL.dLY	Alarm delay	<u>0010 SEC</u>	_____
AL.LED	LED in HOLD mode	<u>OFF</u>	_____

Configuration

Current output: Select sensor type.

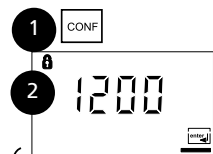

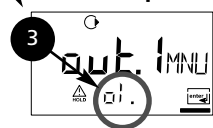

Current output:

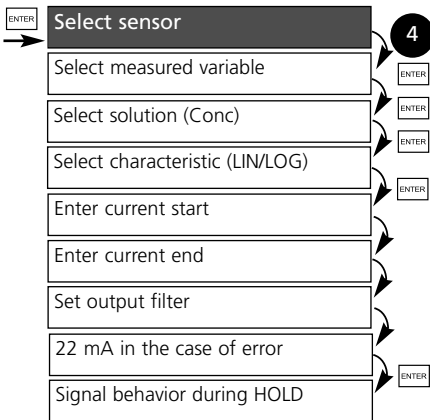

1. Press **CONF** key.
2. Enter passcode **1200**.
3. Select **Current output** menu group using arrow keys. All items of this menu group are indicated by the code "o1."
4. Press **ENTER** to select menu, edit with arrow keys (see Pg 35). Confirm (and proceed) with **ENTER**.
5. End: Press **CONF**, then **ENTER**



* Factory setting, for passcode editing see Pg 52

Code	Display	Action	Choices
o1.		Select configuration (Press CONF.)	
	 <p>After correct input a welcome text (CONF) is displayed for approx. 3 sec.</p>	Enter passcode "1200" (Select position with ▶ key and edit number with ▲ key. When the display reads "1200", press ENTER to confirm.)	
		The Transmitter is in HOLD mode (HOLD icon is on).	
		Select 2-electrode sensor Proceed with ENTER	2-EL (2-El/ 4-El)

Note: Characters represented in gray are flashing and can be edited.

* Factory setting

Configuration

Current output: Select measured variable

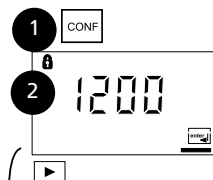



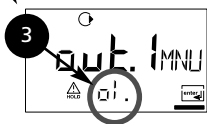

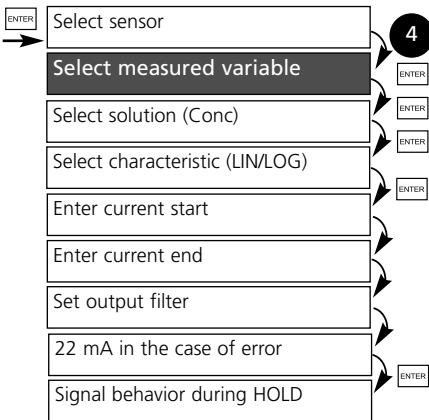

Current output:



1. Press **CONF** key.
2. Enter passcode **1200**.
3. Select **Current output** menu group using arrow keys. All items of this menu group are indicated by the code "o1."
4. Press **ENTER** to select menu, edit with arrow keys (see Pg 37). Confirm (and proceed) with **ENTER**.
5. End: Press **CONF**, then **ENTER**

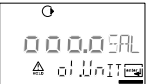

* Factory setting

Code	Display	Action	Choices
o1.	      	<p>Select measured variable:</p> <p>Select with ▶ arrow key Proceed with ENTER</p> <p>Conductivity:</p> <ul style="list-style-type: none"> • 0.000 ... 9.999 $\mu\text{S}/\text{cm}$ • 00.00 ... 99.99 $\mu\text{S}/\text{cm}$ • 000.0 ... 999.9 $\mu\text{S}/\text{cm}$ • 0000 ... 9999 $\mu\text{S}/\text{cm}$ • 0.000 ... 9.999 mS/cm • 00.00 ... 99.99 mS/cm • 000.0 ... 999.9 mS/cm • 0.000 ... 9,999 S/m • 00.00 ... 99.99 S/m <p>Resistivity:</p> <ul style="list-style-type: none"> • 00.00 ... 99.99 $\text{M}\Omega\cdot\text{cm}$ <p>Salinity (SAL):</p> <ul style="list-style-type: none"> • 0.0 ... 45.0 ‰ (0 ... 35 °C) <p>Concentration (Conc):</p> <ul style="list-style-type: none"> • 0.00 ... 9.99 % by wt <p>USP:</p> <ul style="list-style-type: none"> • 00.00 ... 99.99 $\mu\text{S}/\text{cm}$ 	<p>000.0 mS</p> <p>(0.000 μS 00.00 μS 000.0 μS 0000 μS 0.000 mS 00.00 mS 000.0 mS 0.000 S/m 00.00 S/m 00.00 $\text{M}\Omega$ 0.00 SAL 00.00 % USP)</p>

Note: Characters represented in gray are flashing and can be edited.

Configuration

Output 1

Concentration measurement: Select process solutions

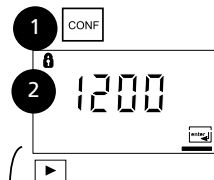

Current output:

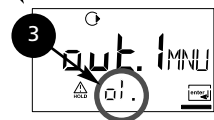

1. Press **CONF** key.
2. Enter passcode **1200***
3. Select **Current output** menu group using arrow keys. All items of this menu group are indicated by the code "o1."
4. Press **ENTER** to select menu, edit with arrow keys (see Pg 39). Confirm (and proceed) with **ENTER**.
5. End: Press **CONF**, then **ENTER**

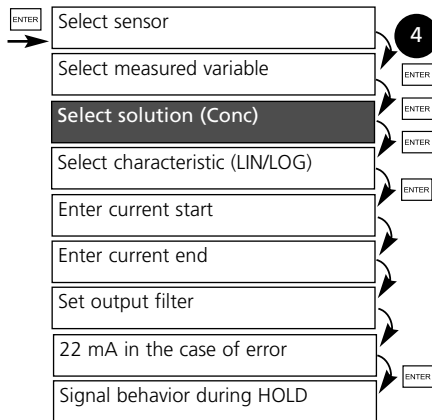

* Factory setting

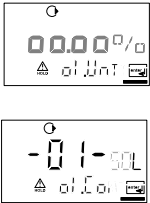
Code	Display	Action	Choices
o1.		<p>Only with 000.0 % you can select the process solution:</p> <p>Select with ► arrow key</p> <p>-01- NaCl (0.00 ... 9.99 % by wt) (0 ... 100 °C)</p> <p>-02- HCl (0.00 ... 9.99 % by wt) (0 ... 50 °C)</p> <p>-03- NaOH (0.00 ... 9.99 % by wt) (0 ... 100 °C)</p> <p>-04- H₂SO₄ (0.00 ... 9.99 % by wt) (0 ... 110 °C)</p> <p>-05- HNO₃ (0.00 ... 9.99 % by wt) (0 ... 50 °C)</p> <p>Proceed with ENTER</p>	<p>-01-SOL</p> <p>(-01-SOL -02-SOL -03-SOL -04-SOL -05-SOL)</p>

Concentration measurement

For the solutions listed above, the Transmitter can determine the substance concentration from the measured conductivity and temperature values in % by wt. The measurement error is made up of the sum of measurements errors during conductivity and temperature measurement and the accuracy of the concentration curves stored in the Transmitter, see Pg 80 et seq. We recommend to calibrate the Transmitter together with the sensor, preferably in the same conductivity range as measured later. For exact temperature measurement, you should perform a temperature probe adjustment. For measuring processes with rapid temperature changes, a separate temperature probe with fast response should be used.

Configuration

Output current. LIN characteristic. Current start / end

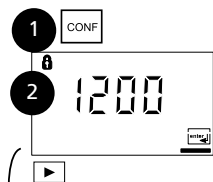

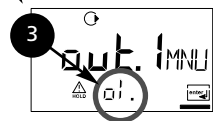

Current output:

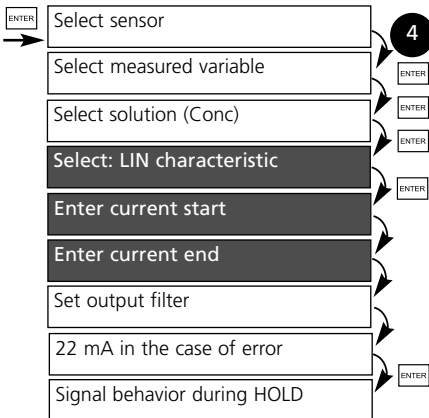

1. Press **CONF** key.
2. Enter passcode **1200***
3. Select **Current output** menu group using arrow keys. All items of this menu group are indicated by the code "o1."
4. Press **ENTER** to select menu, edit with arrow keys (see Pg 41). Confirm (and proceed) with **ENTER**.
5. End: Press **CONF**, then **ENTER**

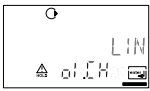

* Factory setting

Code	Display	Action	Choices
01.		Select output characteristic Select with ▶ arrow key Proceed with ENTER (Step omitted for % (Conc) or SAL)	LIN (LIN / LOG)
	 	With LIN selected: • Enter current start (lower end of scale). Select with ▶ key, edit number with ▲ key, proceed with ENTER . • Enter current end (upper end of scale). Proceed with ENTER	000.0 mS (depending on selected range) 100.0 mS (depending on selected range)

Assignment of measured values: current start and current end

Example 1: Range 0...200 mS/cm

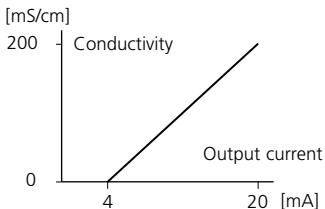

Example 2: Range 100...200 mS/cm
Advantage: Higher resolution in range of interest

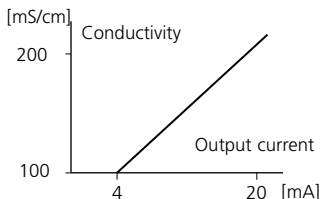

Configuration

Output current. LOG characteristic. Current start / end

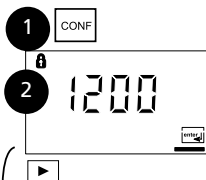



Current output:

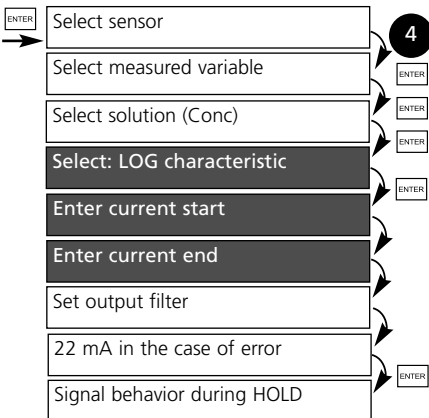

1. Press **CONF** key.
2. Enter passcode **1200**.
3. Select **Current output** menu group using arrow keys. All items of this menu group are indicated by the code "o1."
4. Press **ENTER** to select menu, edit with arrow keys (see Pg 43). Confirm (and proceed) with **ENTER**.
5. End: Press **CONF**, then **ENTER**

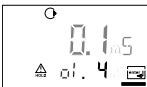

* Factory setting

Code	Display	Action	Choices
01.		With LOG selected: <ul style="list-style-type: none"> • Enter lower end of scale (= current start) Select with ▶ key, edit number with ▲ key, proceed with ENTER .	0.1 mS (depending on selected range)
		<ul style="list-style-type: none"> • Enter upper end of scale (= current end) Select with ▶ key, edit number with ▲ key. Proceed with ENTER	100 mS (depending on selected range)

Example: Measurement range over 3 decades

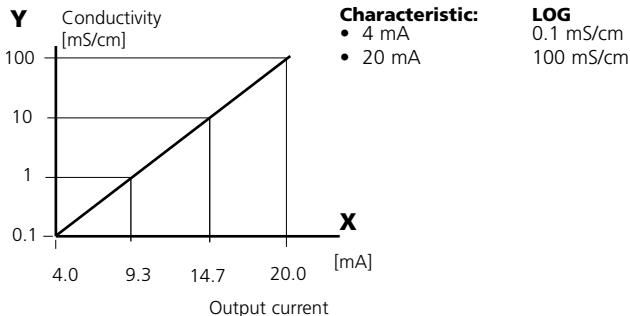

Configuration

Output. Time constant of output filter

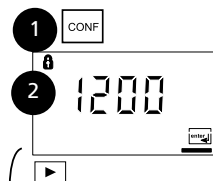

Current output:

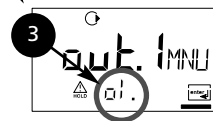

1. Press **CONF** key.
2. Enter passcode **1200**.
3. Select **Current output** menu group using arrow keys. All items of this menu group are indicated by the code "o1."
4. Press **ENTER** to select menu, edit with arrow keys (see Pg 45). Confirm (and proceed) with **ENTER**.
5. End: Press **CONF**, then **ENTER**

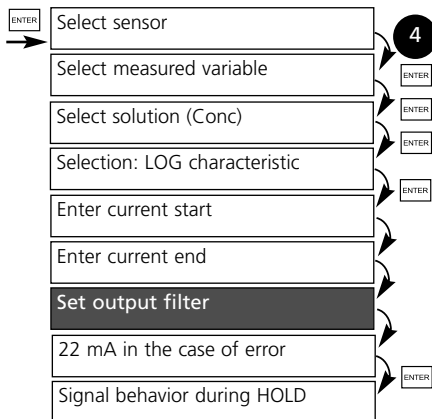

* Factory setting

Code	Display	Action	Choices
01.		Time constant of output filter Default setting: 0 s (inactive). To specify a time constant: Select with ▶ key, edit number with ▲ key, proceed with ENTER	0 sec 0 ... 120 sec

Time constant of output filter (attenuation)

To smoothen the current output, a low-pass filter with adjustable filter time constant can be switched on. When there is a jump at the input (100 %), the output level is 63 % after the time constant has been reached.

The time constant can be set from 0 to 120 sec.

If the time constant is set to 0 s, the current output follows the input.

Note:

The filter only acts on the current output, not on the display!

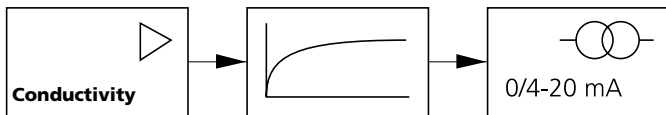

Time constant 0 - 120 sec

Configuration

Output. Output current during Error and HOLD.

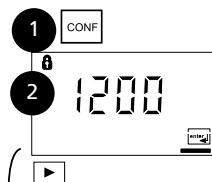

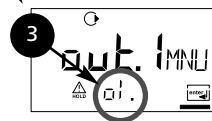

Current output:

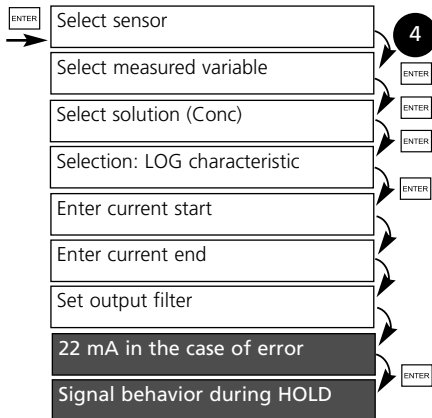

1. Press **CONF** key.
2. Enter passcode **1200**.
3. Select **Current output** menu group using arrow keys. All items of this menu group are indicated by the code "o1."
4. Press **ENTER** to select menu, edit with arrow keys (see Pg 47). Confirm (and proceed) with **ENTER**.
5. End: Press **CONF**, then **ENTER**

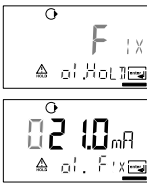

* Factory setting

Code	Display	Action	Choices
o1.		22 mA signal for error message Select with ▶ key Proceed with ENTER	OFF (OFF / ON)
		Output signal during HOLD LAST: During HOLD the last measured value is maintained at the output FIX: During HOLD a value (to be entered) is maintained at the output Select with ▶ key Proceed with ENTER	LAST (LAST / FIX)
		Only with FIX selected: Enter current which is to flow at the output during HOLD Select position with ▶ key and edit number with ▲ key. Proceed with ENTER	021.0 mA (04.0 ... 22.0 mA)

Output signal during HOLD:

(see Pg 28)

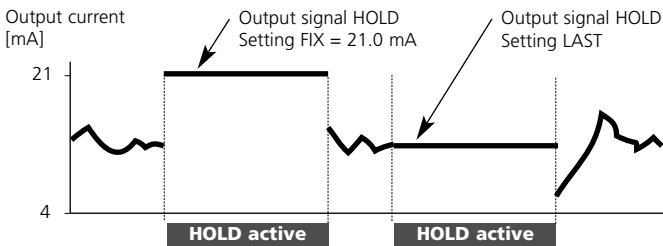

Configuration

Temperature compensation

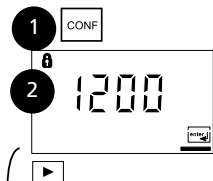

Current output:

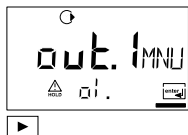

Temp compensation:

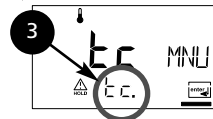

1. Press **CONF** key.
2. Enter passcode **1200**.
3. Select **Temperature compensation** menu group using arrow keys. All items of this menu group are indicated by the code "tc."
4. Edit with arrow keys (see Pg 49). Confirm (and proceed) with **ENTER**.
5. End: Press **CONF**, then **ENTER**

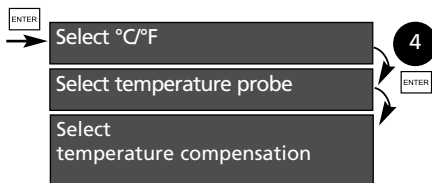

* Factory setting

Code	Display	Action	Choices
tc.		Specify temperature unit Select with ▶ arrow key Proceed with ENTER	°C (°F)
		Select temperature probe Select with ▶ arrow key Proceed with ENTER	NTC8.55 (PT100, PT1000, NTC30)
		Temp compensation selection (not for USP, CONC, SAL) OFF: Temperature compensation switched off. Select with ▶ key, proceed with ENTER LIN: Linear temperature compen- sation with entry of temperature coefficient and reference tempera- ture. nLF: Temperature compensation for natural waters to EN 27888 NaCl (nACL): Temperature compensation for ultrapure water with NaCl traces HCl (HCL): Temperature compensation for ultrapure water with HCl traces NH₃ (nH3): Temperature compensation for ultrapure water with NH ₃ traces	OFF (OFF LIN nLF nACL HCL nH3)
	Only with linear temperature compensation (LIN) selected: Enter temperature coefficient*. Select position with ▶ key, edit number with ▲ key. Proceed with ENTER		

* Reference temperature 25 °C

Configuration

Alarm settings

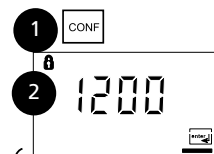

Current output:

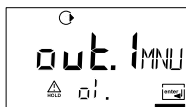

Temp compensation:



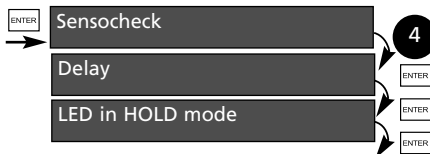

Alarm settings:



1. Press **CONF** key.
2. Enter passcode **1200***
3. Select **Alarm settings** menu group using arrow keys. All items of this menu group are indicated by the code "AL."
4. Press **enter** to select menu, edit with arrow keys (see Pg 51). Confirm (and proceed) with **ENTER**.
5. End: Press **CONF**, then **ENTER**

* Factory setting

Code	Display	Action	Choices								
AL.		Select Sensocheck (Continuous monitoring of sensor properties) Select with ► key. Proceed with ENTER	OFF (ON / OFF)								
		Alarm delay Select with ► key, edit number with ▲ key, proceed with ENTER	0010 s (xxxx s)								
		LED in HOLD mode Select with ► key, proceed with ENTER LED in HOLD mode: <table border="1" data-bbox="394 793 781 903"> <thead> <tr> <th>Configuration</th> <th>Alarm</th> <th>HOLD</th> </tr> </thead> <tbody> <tr> <td>ON</td> <td>on</td> <td>flashes</td> </tr> <tr> <td>OFF</td> <td>flashes</td> <td>off</td> </tr> </tbody> </table>	Configuration	Alarm	HOLD	ON	on	flashes	OFF	flashes	off
Configuration	Alarm	HOLD									
ON	on	flashes									
OFF	flashes	off									







Passcodes according to FDA 21 CFR Part 11







Access to the device functions can be protected with adjustable passcodes if required.

If such a protection is not required, you should use the preset passcodes.

To call up passcode editor:

Press **CONF** key and enter Administrator passcode (Factory setting:**1989**).

Display	Action	Remark
	1. Press CONF key. 2. Enter Administrator passcode (1989): Welcome text is displayed	This text is displayed for approx. 3 s
	"Cal Info" Edit: Arrow keys Proceed with: ENTER Cancel: CONF	Default setting: 0000
	"Cal - Input of cell constant" Edit: Arrow keys Proceed with: ENTER Cancel: CONF	Default setting: 1100
	"Cal - with cal solution" Edit: Arrow keys Proceed with: ENTER Cancel: CONF	Default setting: 0110
	"Product calibration" Edit: Arrow keys Proceed with: ENTER Cancel: CONF	Default setting: 1105
	"Temp probe adjustment" Edit: Arrow keys Proceed with: ENTER Cancel: CONF	Default setting: 1015

Display	Action	Remark
	"Error Info" Edit: Arrow keys Proceed with: ENTER Cancel: CONF	Default setting: 0000
	"Configuration" Edit: Arrow keys Proceed with: ENTER Cancel: CONF	Default setting: 1200
	"Sensor monitor" Edit: Arrow keys Proceed with: ENTER Cancel: CONF	Default setting: 2222
	"Current source" Edit: Arrow keys Proceed with: ENTER Cancel: CONF	Default setting: 5555
	"Administrator passcode" Edit: Arrow keys Proceed with: ENTER Cancel: CONF	Default setting: 1989
	<ul style="list-style-type: none"> • "NO" to cancel new Administrator passcode Proceed with ENTER (old passcode) Cancel: CONF (old passcode) 	Caution! If you have lost the Administrator passcode, the Passcode Editor cannot be called up! Please consult our technical support!
	<ul style="list-style-type: none"> • "YES" to take over new Administrator passcode Select "YES" with arrow keys. Accept with ENTER (new passcode) Cancel: CONF (old passcode) 	

Calibration

Calibration adjusts the device to the sensor.

Activate



Activate with **CAL**



Enter passcode*:

- 1100 Entry of cell constant
 - 0110 With calibration solution
 - 1105 Product calibration
 - 1015 Temp probe adjustment
- Select with **▶** key, edit number with **▲** key, proceed with **ENTER** key (End with **CAL + ENTER.**)

Hold



During calibration the Transmitter remains in the Hold mode.



HOLD icon

The loop current is frozen (at its last value or at a preset fixed value, depending on the configuration), Sensoface is off, mode indicator "Calibration" is on.

Input errors

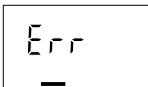

The calibration parameters are checked during the input. In the case of an incorrect input "Err" is displayed for approx. 3 s. The incorrect parameters cannot be stored. Input must be repeated.

End



End with **CAL**.

Safety prompt:

The measured value and Hold are displayed alternately, "enter" flashes. Press **ENTER** to end the Hold mode. The measured value is displayed. The output current remains frozen for another 20 sec (HOLD icon on, "hourglass" flashes).

* Factory setting, for passcode editing see Pg 52

Information on calibration

Calibration adapts the Transmitter to the conductivity sensor. Calibration can be performed by:

- Input of cell constant (e.g. for ultrapure-water sensors)
- Determining the cell constant with a known calibration solution
- Sampling (product calibration)
- Temperature probe adjustment







Note:

- All calibration procedures must be performed by trained personnel.
- During the calibration procedure the temperature must be kept constant.
- Incorrectly set parameters may go unnoticed, but change the measuring properties.

Particularly with stray-field sensors the cell constant can strongly vary when the sensor is mounted in restricted space. In that case, the cell constant should be determined with the sensor mounted using a calibration solution or by a reference measurement at the product.

Calibration by input of cell constant

Input of cell constant with simultaneous display of the uncompensated conductivity value and the temperature





Display	Action	Remark
	Press CAL key, enter passcode 1100* Select with ▶ key, edit number with ▲ key, proceed with ENTER	Transmitter is in the Hold mode. If an invalid pass-code is entered, Transmitter returns to measuring mode.
	Ready for calibration	Display (3 s)
   	Enter the PRODUCT of the Cell Constant and Cell Calibration Factor found on the sensor. i.e. Constant 0.01 x Factor 1.07. Enter 0.0107. Select with ▶ key, edit number with ▲ key. A change in the cell constant also changes the conductivity value. Press ENTER to confirm cell constant.	The lower display shows the conductivity value. (When there has not been an entry for 6 sec, the lower display alternately shows the conductivity and temperature value.)

* Factory setting



Display	Action	Remark
	<p>The Transmitter now displays the conductivity and temperature.</p> <p>The measured value is shown in the main display alternately with "Hold"; "enter" flashes. End calibration with ENTER.</p>	<p>Safety prompt</p> <p>After end of calibration, the outputs remain in Hold mode for approx. 20 sec.</p>

Calibration with calibration solution

Input of temperature-corrected value of calibration solution with simultaneous display of cell constant

Display	Action	Remark
	Press CAL key, enter passcode 0110* Select with ▶ key, edit number with ▲ key, proceed with ENTER	Transmitter is in the Hold mode. If an invalid pass- code is entered, Transmitter returns to measuring mode.
	Ready for calibration Dismount and clean sensor	Display (3 sec)
	Immerse sensor in calibration solution. Determine the temperature- corrected conductivity value of the calibration solution from the corresponding table (see Pg 78 et seq.).	When there has not been an entry for 6sec, the lower display alternately shows the cell constant and temperature value.
 	Enter value of calibration solution. Select with ▶ key, edit number with ▲ key. Press ENTER to confirm the calibration data.	The cell constant and temperature are alternately displayed in the lower display during the input.

* Factory setting

Display	Action	Remark
	<p>The determined cell constant is displayed. Confirm with ENTER.</p>	
	<p>Clean sensor and re-place it in the process. The Transmitter now displays the conductivity and temperature.</p> <p>The measured value is shown in the main display alternately with "Hold"; "enter" flashes. End calibration with ENTER.</p>	<p>Safety prompt</p> <p>After end of calibration, the outputs remain in Hold mode for approx. 20 sec.</p>

Notes :

(also see Pg 55)

- Be sure to use known calibration solutions and the respective temperature-corrected conductivity values. (see "Calibration solutions" Pg 78 et seq.).
- During the calibration procedure the temperature must be kept constant.
- For a good mass transfer, the solution should be stirred.

Product calibration



Calibration by sampling

For product calibration the measured variable is used as configured: Conductivity ($\mu\text{S}/\text{cm}$, mS/cm , S/m), resistivity ($\text{M}\Omega\cdot\text{cm}$). During product calibration the sensor remains in the process. The measurement is only interrupted briefly.





Calibration is without TC correction.

Procedure: During sampling the currently measured value is stored in the Transmitter. The Transmitter immediately returns to measuring mode. The calibration mode indicator flashes and reminds you that calibration has not been terminated.

The sample is measured in the lab or directly on the site using a portable meter. To ensure an exact calibration, the sample temperature should correspond to the measured process temperature. The sample value is then entered in the Transmitter. The new cell constant is calculated from these two values. If the sample is invalid, you can take over the value stored during sampling. In that case the old calibration values are stored. Afterwards, you can start a new product calibration.



Display	Action	Remark
	<u>Product calibration step 1:</u> Press CAL key. Enter passcode 1105*. (Press ▶ key to select position, enter number using ▲ key, confirm with ENTER)	If an invalid passcode is entered, Transmitter returns to measuring mode.
		Display (approx. 3 sec)
	Take sample and store value. Proceed with ENTER	The sample is measured in the lab or directly on the site.

* Factory setting

Display	Action	Remark
	<p>Measuring mode:</p> <p>From the flashing CAL mode indicator you see that product calibration has not been terminated.</p>	<p>While the sample value is determined, the Transmitter is in measuring mode.</p>
	<p><u>Product calibration step 2:</u> When the sample value has been determined, call up the product calibration once more (CAL, passcode 1105*).</p>	<p>Display (approx. 3 sec)</p>
	<p>Enter lab value. The new cell constant is calculated.</p>	
	<p>The new cell constant is displayed.</p> <p>Confirm with ENTER.</p>	<p>New calibration: Press CAL.</p>
	<p>The measured value is shown in the main display alternately with "Hold"; "enter" flashes. End with ENTER.</p>	<p>Safety prompt. After end of calibration, the outputs remain in Hold mode for approx. 20 sec.</p>

* Factory setting









Temp probe adjustment

Display	Action	Remark
	Activate calibration (Press CAL . Enter passcode 1015*.) Select with ▶ key, edit number with ▲ key, proceed with ENTER .	Wrong settings change the measurement properties! If an invalid passcode is entered, Transmitter returns to measuring mode.
	Ready for calibration	Transmitter is in the Hold mode. Display for approx. 3 sec
	Measure the temperature of the process medium using an external thermometer. Enter measured temperature value: Select with ▶ , edit number with ▲ , proceed with ENTER . End adjustment with ENTER . HOLD will be deactivated after 20 sec.	Default: Value of secondary display.

Measurement



Display	Remark
	In the measuring mode the main display shows the configured process variable (conductivity, concentration, resistivity, salinity), the lower display shows the temperature. During calibration you can return to measuring mode by pressing the CAL key, during configuration by pressing CONF and then ENTER (waiting time for measured-value stabilization approx. 20 sec).

* Factory setting

Entry/display	Remark
 	<p>Display of output currents Press ENTER while in measuring mode. For 5 sec, the secondary display shows the output current instead of the temperature</p>
 0000* 	<p>Display of calibration data (Cal Info) Press CAL while in measuring mode and enter passcode 0000*. The current cell constant is shown in the main display. After 20 sec the Transmitter returns to measuring mode (immediate return at pressing ENTER).</p>
 2222* 	<p>Sensor monitor for validation of sensor and complete measured-value processing. Press CONF while in measuring mode and enter passcode 2222*. The measured resistance is shown in the main display, the measuring temperature in the lower display. Press ENTER to return to measurement.</p>
 0000* 	<p>Display of last error message (Error Info) Press CONF while in measuring mode and enter passcode 0000*. The last error message is displayed for approx. 20 sec. After that the message will be deleted (immediate return to measurement at pressing ENTER).</p>

* Factory setting

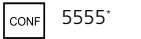



















Diagnostics functions

Entry/display	Action / Remarks
  	<p>Specify output current for testing the connected peripherals</p> <ul style="list-style-type: none">• Press CONF, enter passcode 5555* <p>The output current indicated in the main display can be modified. Select with ▶ key, edit number with ▲ key, proceed with ENTER.</p> <p>The actually measured current is shown in the secondary display. The Transmitter is in Hold mode. Press CONF, then ENTER to return to measurement (Hold remains active for another 20 sec).</p>

Cleaning

To remove dust, dirt and spots, the external surfaces of the device may be wiped with a damp, lint-free cloth. A mild household cleaner may also be used if necessary.

* Factory setting

Operating state	Out	LED	Time out
Measurement			
Cal Info (CAL) 0000			20 s
Error Info (CONF) 0000			20 s
Calibration (CAL) 1100			
Temp adjustment (CAL) 1015			
Product cal 1 (CAL) 1105			
Product cal 2 (CAL) 1105			
Configuration (CONF) 1200			20 min
Sensor monitor (CONF) 2222			20 min
Current source (CONF) 5555			20 min

Explanation:



active











as configured (Last/Fix or Last/Off)



LED flashes during HOLD (configurable)

Error messages (error codes)

Error	Display	Problem Possible causes	Red LED	Out 1 (22 mA)
ERR 01	Measured value flashes	Sensor <ul style="list-style-type: none"> • Wrong cell constant • Measurement range violation • SAL > 45 ‰ • Sensor connection or cable defective • USP limit exceeded 	x	x
ERR 02	Measured value flashes	Unsuitable sensor Conductance range > 3500 mS	x	x
ERR 98	"Conf" flashes	System error Configuration or calibration data defective. Completely reconfigure and recalibrate the device. Memory error in device program	x	x
ERR 99	"FAIL" flashes	Factory settings EEPROM or RAM defective This error message only occurs in the case of a total defect. The Transmitter must be repaired and recalibrated at the factory.	x	x
ERR 03		Temperature probe Open or short circuit Temperature range exceeded	x	x

Error	Symbol (flashes)	Problem Possible causes	Red LED	Out 1 (22 mA)
ERR 11		Current output Current below 3.8 mA	x	x
ERR 12		Current output Current above 20.5 mA	x	x
ERR 13		Current output Current span too small / too large	x	x
ERR 33	 	Sensocheck: Wrong or defective sensor / Polarization effects at the sensor / cable too long or defective / plug defective	x	x
			Sensoface active see Pg 69	
	 	Temperature outside conversion tables (TC, Conc, SAL)	independent of Sensoface	

Sensoface

(Sensochek must have been activated during configuration.)

The little smiley in the display (Sensoface) provides information about the sensor condition (defects, maintenance required, cable capacitance too high).

It alerts to significant sensor polarization or excessive cable capacitance e.g. caused by an unsuitable cable or a cable that is too long. The permitted calibration ranges and the conditions for a friendly, neutral, or sad Sensoface are summarized in the following chart. Additional icons refer to the error cause.

Sensochek

Continuously monitors the sensor and its wiring.

Sensochek can be switched off. Critical values make the Sensoface “sad” and the corresponding icon flashes:







The Sensochek message is also output as error message Err 33. The red LED is lighted, the output current is set to 22 mA (when configured correspondingly). Sensochek can be switched off during configuration (then Sensoface is also disabled). Exception: After a calibration a Smiley is always displayed for confirmation.

Note:

The worsening of a Sensoface criterion leads to the devaluation of the Sensoface indicator (Smiley becomes “sad”).

To reset the Sensoface indicator, the defect must be remedied and the Transmitter be calibrated.

Display	Problem	Status
	Sensor defect	 Wrong or defective sensor Significant polarization of sensor Excessive cable capacitance (also see error message Err 33, Pg 67).
	Temperature error	 Temperature outside range for TC, conc, SAL

Note:

When very fast response times (t_{90}) are required, e.g. when **detecting separation layers**, Sensocheck should be switched off (see "Specifications" Pg 74).

USP function

According to the "USP" directive (U.S. Pharmacopeia), Section 645 "Water Conductivity", the conductivity of pharmaceutical waters can be monitored online. To do so, the conductivity is measured without temperature compensation and is compared with limit values (see "Temperature/conductivity table as per USP" on Pg 71).

The water is usable if the conductivity is below the USP limit. For higher conductivities, further test steps must be performed according to the directive.

If the measured value exceeds the USP limit, ERR01 will be displayed (see Pg 66).

Configuration

out1 \ 01.UniT menu group:

When USP function has been selected, the measurement range is fixed to 00.00 ... 99.99 $\mu\text{S}/\text{cm}$.

Temperature compensation is switched off.

Temperature is monitored (see Pg 37).

Temperature/conductivity table as per USP

Temp in °C	Conductivity in $\mu\text{S}/\text{cm}$	Temp in °C	Conductivity in $\mu\text{S}/\text{cm}$
0	0.6	55	2.1
5	0.8	60	2.2
10	0.9	65	2.4
15	1.0	70	2.5
20	1.1	75	2.7
25	1.3	80	2.7
30	1.4	85	2.7
35	1.5	90	2.7
40	1.7	95	2.9
45	1.8	100	3.1
50	1.9		

Product line and accessories

Devices

Order No.

Conductivity Transmitter
with HART communication
for application in safe areas or
hazardous locations DIV 2
(USA/Canada only)

APT2000CC-H-00

Conductivity Transmitter
with HART communication
for application in hazardous
locations DIV 1 (USA/Canada) /
Zone 1 (Europe)

APT2000CC-H-IS

Mounting accessories

Order No.

Pipe-mount kit

51205988-001

Panel-mount kit

51205990-001

Protective hood

51205989-001

Further accessories

HART test socket,
integrated in Pg cable gland

51205991-001

Specifications

Conductivity input

Effective range

Ranges *

Input for 2-electrode sensors

Conductivity	0.2 $\mu\text{S} \cdot \text{cm}^{-1}$... 200 $\text{mS} \cdot \text{cm}^{-1}$
Conductivity	0.000 ... 9.999 $\mu\text{S}/\text{cm}$ 00.00 ... 99.99 $\mu\text{S}/\text{cm}$ 000.0 ... 999.9 $\mu\text{S}/\text{cm}$ 0000 ... 9999 $\mu\text{S}/\text{cm}$ 0.000 ... 9.999 mS/cm 00.00 ... 99.99 mS/cm 000.0 ... 999.9 mS/cm 0.000 ... 9.999 S/m 00.00 ... 99.99 S/m
Resistivity	00.00 ... 99.99 $\text{M}\Omega \cdot \text{cm}$
Concentration	0.00 ... 9.99 % by wt
Salinity	0.0 ... 45 ‰ (0 ... 35 °C)
USP	00.00 ... 99.99 $\mu\text{S}/\text{cm}$

Measurement error ^{1,2,3)}

< 1 % meas. val. +0.4 $\mu\text{S} \cdot \text{cm}^{-1}$

Concentration determination

Operating modes *

-01- NaCl	0,00 ... 9.99 % by wt (0 ... 100 °C)
-02- HCl	0,00 ... 9.99 % by wt (0 ... 50 °C)
-03- NaOH	0,00 ... 9.99 % by wt (0 ... 100 °C)
-04- H ₂ SO ₄	0.00 ... 9.99 % by wt (0 ... 110 °C)
-05- HNO ₃	0.00 ... 9.99 % by wt (0 ... 50 °C)

See graphs in the Appendix Pg 80 and following

Sensor standardization

Operating modes

- Input of cell constant with simultaneous display of conductivity and temperature
- Input of conductivity of calibration solution with simultaneous display of cell constant and temperature
- Product calibration
- Temperature probe adjustment

Adm. cell constant

00.0050 ... 19.9999 cm^{-1}

Sensor monitoring

Sensocheck

Polarization detection and monitoring of cable capacitance

Sensoface

Provides information on the sensor condition (Sensocheck)

Sensor monitor

Direct display of measured values from sensor for validation (resistance / temperature)

USP function

Water monitoring in the pharmaceutical industry (USP)

Temperature input *

Pt100 / Pt1000/ NTC 30 k Ω /
NTC 8.55 k Ω (Betatherm)

2-wire connection, adjustable

Ranges

NTC 8.55 k Ω -10 ... +130 °C
(+14 ... +266 °F)

NTC 30 k Ω -20 ... +150 °C
(-4 ... +302 °F)

Pt100/Pt1000 -20 .. +200 °C
(-4 ... +392 °F)

Resolution

0.1 °C / 1 °F

Measurement error ^{1,2,3)}

0.5 K

(< 1K for Pt100; < 1K for NTC > 100°C)

Temperature compensation *

(Reference temp 25 °C)

(OFF) none

(Lin) Linear characteristic 00.00 ... 19.99 %/K

(NLF) Natural waters to EN 27888

(nACL) Ultrapure water with NaCl traces (0...120°C)

(HCL) Ultrapure water with HCl traces (0...120°C)

(nH3) Ultrapure water with NH₃ traces (0...120°C)

Specifications

Loop current	4 ... 20 mA floating
Supply voltage	14 ... 30 V
Measured variable *	Conductivity, resistivity, concentration, or salinity
Characteristic	Linear or logarithmic
Overrange *	22 mA in the case of error messages
Output filter *	Low-pass, filter time constant 0 ... 120 sec
Measurement error ¹⁾	< 0.3 % current value + 0.05 mA
Start/end of scale	As desired within range
Min. span	LIN: 5 % of selected range LOG: 1 decade
Current source function	3.8 mA ... 22 mA
HART communication	Digital communication by FSK modulation of loop current, reading of device identification, measured values, status and messages, reading and writing of parameters, start of product calibration, signaling of configuration changes according to FDA 21 CFR Part 11
Display	LC display, 7-segment with icons
Main display	Character height 17 mm, unit symbols 10 mm
Secondary display	Character height 10 mm, unit symbols 7 mm
Sensoface	3 status indicators (friendly, neutral, sad Smiley)
Status indication "config"	4 mode indicators "MEAS", "CAL", "ALARM", "config"
Alarm indication	18 further icons for configuration and messages Red LED in case of alarm or HOLD, user defined
Keypad	5 keys: [CAL] [CONF] [▶] [▲] [ENTER]

* User-defined

1) To IEC 746 Part 1, at nominal operating conditions

2) ± 1 count

3) Plus sensor error

Service functions

Current source	Loop current specifiable 3.8 ... 22.00 mA
Device self-test	Automatic memory test (RAM, FLASH, EEPROM)
Display test	Display of all segments
Last Error	Display of last error occurred
Sensor monitor	Display of direct, uncorrected sensor signal (resistance/temperature)
Passcodes	Modifiable according to FDA 21 CFR Part 11 "Electronic Signatures"

Data retention

Parameters and calibration data > 10 years (EEPROM)

EMC

EN 61326

Emitted interference:

Class B (residential area)

Class A

Immunity to interference:

Industry

Explosion protection

(APT2000CC-H-IS)

II 2 (1) G EEx ib [ia] IIC T6

FM:

FM IS, Cl.1, Div1, Group A,B,C & D T4

NI, Cl.1, Div2, Group A,B,C & D T4

Nominal operating conditions

Ambient temperature -20 ... +55 °C

Transport/Storage temp -20 ... +70 °C

Supply voltage 14... 30 V

Enclosure

Molded enclosure made of PBT (polybutylene terephthalate)

Bluish gray RAL 7031

Color

Assembly

• Wall mounting

• Pipe mounting:

Ø 40 ... 60 mm, □ 30 ... 45 mm

• Panel mounting, cutout to DIN 43 700

Sealed against panel

Dimensions

H 144 mm, B 144 mm, T 105 mm

Ingress protection

IP 65/NEMA 4X

(USA, Canada: indoor use only)

Cable glands

3 breakthroughs for cable glands

M20x1.5, 2 breakthroughs for NPT 1/2" or

Rigid Metallic Conduit

Weight

Approx. 1 kg

Calibration solutions

Potassium chloride solutions

(Conductivity in mS/cm)

Temperature [°C]	Concentration *		
	0.01 mol/l	0.1 mol/l	1 mol/l
0	0.776	7.15	65.41
5	0.896	8.22	74.14
10	1.020	9.33	83.19
15	1.147	10.48	92.52
16	1.173	10.72	94.41
17	1.199	10.95	96.31
18	1.225	11.19	98.22
19	1.251	11.43	100.14
20	1.278	11.67	102.07
21	1.305	11.91	104.00
22	1.332	12.15	105.94
23	1.359	12.39	107.89
24	1.386	12.64	109.84
25	1.413	12.88	111.80
26	1.441	13.13	113.77
27	1.468	13.37	115.74
28	1.496	13.62	
29	1.524	13.87	
30	1.552	14.12	
31	1.581	14.37	
32	1.609	14.62	
33	1.638	14.88	
34	1.667	15.13	
35	1.696	15.39	
36		15.64	

* Data source: K. H. Hellwege (Editor), H. Landolt, R. Börnstein: Zahlenwerte und Funktionen ..., volume 2, part. volume 6

Sodium chloride solutions

(Conductivity in mS/cm)

Temperature [°C]	Concentration		
	0.01 mol/l *	0.1 mol/l *	saturated **
0	0.631	5.786	134.5
1	0.651	5.965	138.6
2	0.671	6.145	142.7
3	0.692	6.327	146.9
4	0.712	6.510	151.2
5	0.733	6.695	155.5
6	0.754	6.881	159.9
7	0.775	7.068	164.3
8	0.796	7.257	168.8
9	0.818	7.447	173.4
10	0.839	7.638	177.9
11	0.861	7.831	182.6
12	0.883	8.025	187.2
13	0.905	8.221	191.9
14	0.927	8.418	196.7
15	0.950	8.617	201.5
16	0.972	8.816	206.3
17	0.995	9.018	211.2
18	1.018	9.221	216.1
19	1.041	9.425	221.0
20	1.064	9.631	226.0
21	1.087	9.838	231.0
22	1.111	10.047	236.1
23	1.135	10.258	241.1
24	1.159	10.469	246.2
25	1.183	10.683	251.3
26	1.207	10.898	256.5
27	1.232	11.114	261.6
28	1.256	11.332	266.9
29	1.281	11.552	272.1
30	1.306	11.773	277.4
31	1.331	11.995	282.7
32	1.357	12.220	288.0
33	1.382	12.445	293.3
34	1.408	12.673	298.7
35	1.434	12.902	304.1
36	1.460	13.132	309.5

* Data source: Test solutions calculated according to DIN IEC 746-3

** Data source: K. H. Hellwege (Editor), H. Landolt, R. Börnstein: Zahlenwerte und Funktionen ..., volume 2, part. volume 6

Concentration curves

-01- Sodium chloride solution NaCl

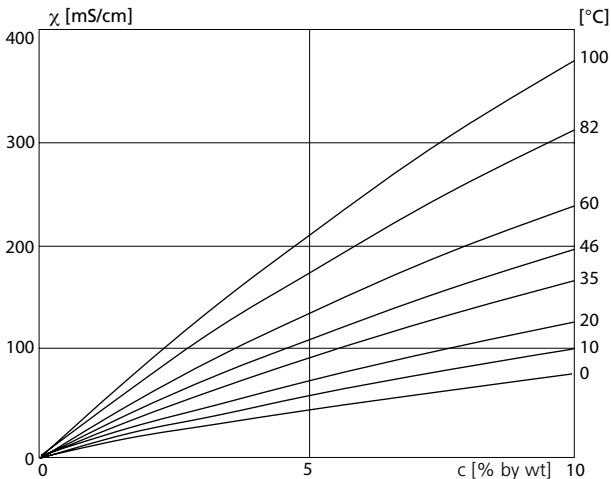

Conductivity in dependence on substance concentration and process temperature for sodium chloride solution (NaCl)

-02- Hydrochloric acid HCl

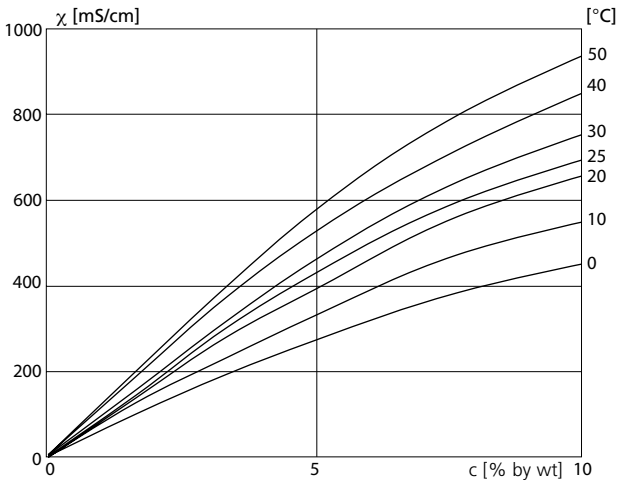

Conductivity in dependence on substance concentration and process temperature for hydrochloric acid (HCl)

Source: Haase/Sauermann/Dücker; Z. phys. Chem. New Edition, Vol. 47 (1965)

Concentration curves

-03- Sodium hydroxide solution NaOH

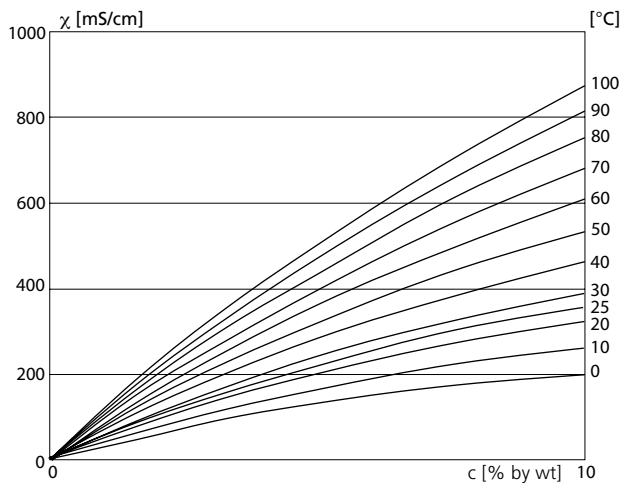

Conductivity in dependence on substance concentration and process temperature for sodium hydroxide solution (NaOH)

-04- Sulphuric acid H_2SO_4

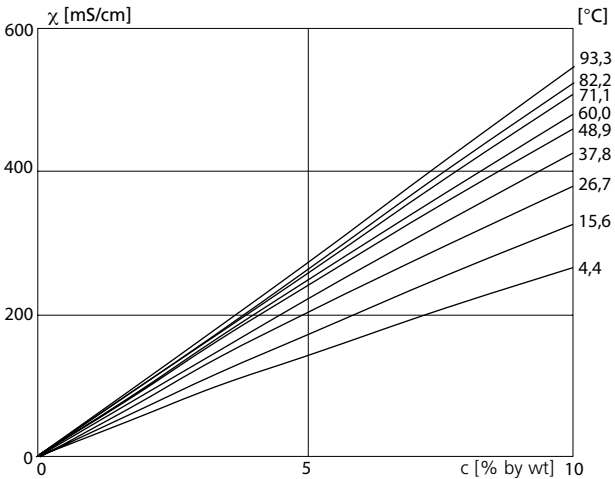

Conductivity in dependence on substance concentration and process temperature for sulfuric acid (H_2SO_4)

Source: Darling; Journal of Chemical and Engineering Data; Vol. 9 No. 3, July 1964

Concentration curves

-05- Nitric acid HNO_3

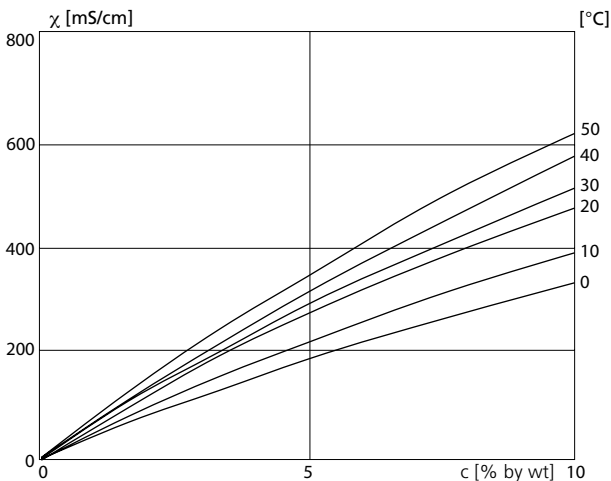

Conductivity in dependence on substance concentration and process temperature for nitric acid (HNO_3)

Source: Haase/Sauermann/Dücker; Z. phys. Chem. New Edition, Vol. 47 (1965)

Division 2 wiring



The connections to the Transmitter must be installed in accordance with the National Electric Code (ANSI-NFPA 70) Division 2 hazardous (classified) location, non-incendive wiring techniques.

FM Control Drawing

Measurement Loop Hazardous Area Location

IS Class I, Division 1, Groups A, B, C, D
 IS Class II, Division 1, Groups E, F, G
 IS Class III, Division 1
 IS Class I, Zone D, Group IIC

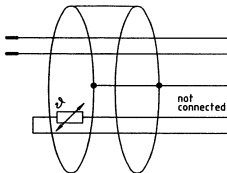

Hazardous Location Class I, Div 1

2-Wire Transmitter (intrinsically safe apparatus)
 APT2000CC-0-IS and APT2000CC-H-IS
 IS, Class I, Division 1, Groups A, B, C, D, T4 @ 55°C; Type 2
 Class I, Zone 1, IIC, T4 @ 55°C; Type 2

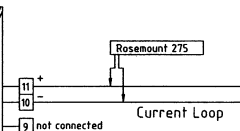

Conductivity-Measuring Loop

Entity Parameters: Terminals 1, 2, 3, 4, 5, and 6
 $V_i, U_0 = 10\text{ V}$; $I_i, I_0 = 14.3\text{ mA}$; $P_{max}, P_0 = 357\text{ mW}$
 Class I, Division 1, Groups A & B Class I, Zone 1, IIC
 $C_a, C_0 = 3\text{ }\mu\text{F}$; $L_a, L_0 = 1.6\text{ mH}$
 Class I & II, Division 1, Groups C & E Class I, Zone 1, IIB
 $C_a, C_0 = 9\text{ }\mu\text{F}$; $L_a, L_0 = 7\text{ mH}$
 Class I, II, III Division 1, Groups D, F & G Class I, Zone 1, IIA
 $C_a, C_0 = 24\text{ }\mu\text{F}$; $L_a, L_0 = 13\text{ mH}$

Temp-Measuring Loop

Entity Parameters: Terminals 7 and 8
 $V_{oc}, U_0 = 5\text{ V}$; $I_{sc}, I_0 = 3\text{ mA}$; $P_{max}, P_0 = 4\text{ mW}$
 Class I, Division 1, Groups A & B Class I, Zone 1, IIC
 $C_a, C_0 = 2000\text{ }\mu\text{F}$; $L_a, L_0 = 1\text{ H}$
 Class I & II, Division 1, Groups C & E Class I, Zone 1, IIB
 $C_a, C_0 = 6000\text{ }\mu\text{F}$; $L_a, L_0 = 1\text{ H}$
 Class I, II, III Division 1, Groups D, F & G Class I, Zone 1, IIA
 $C_a, C_0 = 16000\text{ }\mu\text{F}$; $L_a, L_0 = 1\text{ H}$

Entity Parameters: Terminals 10 and 11

$V_{max}, U_i = 30\text{ V}$ $C_i = 32.4\text{ nF}$
 $I_{max}, I_i = 100\text{ mA}$ $L_i = 240\text{ }\mu\text{H}$
 $P_{max}, P_i = 0.8\text{ W}$

Entity Parameters: Terminals 1, 2, 3, 4, 5, 6, 7 and 8
 $V_i, U_0 = 10\text{ V}$; $I_i, I_0 = 14.6\text{ mA}$; $P_i, P_0 = 365\text{ mW}$
 Class I, Division 1, Groups A & B Class I, Zone 1, IIC
 $C_a, C_0 = 3\text{ }\mu\text{F}$; $L_a, L_0 = 1.6\text{ mH}$
 Class I & II, Division 1, Group C Class I, Zone 1, IIB
 $C_a, C_0 = 9\text{ }\mu\text{F}$; $L_a, L_0 = 7\text{ mH}$
 Class I, II, III Division 1, Group D Class I, Zone 1, IIA
 $C_a, C_0 = 24\text{ }\mu\text{F}$; $L_a, L_0 = 13\text{ mH}$

Non-Hazardous Location

Transmitter Power Supply
(associated apparatus)

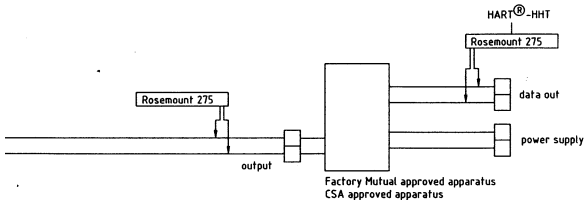

NOTES :

- $V_{max} \cdot U_i > V_{oc} \cdot V_t \text{ or } U_o$ $I_{max} \cdot I_i > I_{sc} \cdot I_t \text{ or } I_o$ $P_{max} > P_o$
 $C_i + C_{cable} < C_a \text{ or } C_o$ $L_i + L_{cable} < L_a \text{ or } L_o$
- Installation must be in accordance with the National Electrical Code (ANSI/NFPA 70) and ANSI/ISA RP12.6 in US, Canadian Electric Code (Can3-M421) in Canada.
- Associated apparatus must be FMRC and CSA Approved and must be used in an FMRC and CSA Approved configuration. Use of the Rosemount Model 275 Communicator in Zones is not an FMRC Approved configuration. The control drawing for the associated apparatus must be followed when installing this equipment.
- Control equipment connected to the associated apparatus must not use or generate more than 250 V.
- The intrinsically safe equipment connecting to 1, 2, 3, 4, 5, 6 and 7, 8 must be FMRC and CSA Approved or be simple apparatus (a device which will neither generate nor store more than 1.2 V, 0.1 A, 25 mW or 20 mJ).
- No revisions to drawing without prior FMRC and CSA Approval.
- Use of the Rosemount Model 275 Communicator is FM Approved for Division use only, see note 3. When using the Rosemount Model 275 Communicator in the loop between the associated apparatus and the APT2000CC-H-IS 2-Wire Transmitter, the maximum loop inductance must be less than the marked L_a of the associated apparatus to account for the I_{sc} from the Model 275 Communicator. Refer to the Rosemount Installation Drawing 00275-0081 to determine the allowable loop inductance.
- The Rosemount Model 275 Communicator is not approved by CSA for use in the entity concept. For CSA application the Rosemount Model 275 Communicator must only be used on the non-hazardous side of the barrier/transmitter power supply.

Version Honeywell

Verteiler: FRL (Zz)			Zul. Abweichungen für Maße ohne Toleranzangabe ISO 2768 - m	Oberfläche	Maßstab 1:1	
					Halbzeug	
				Datum	Name	Bearbeitung
				10.03.00	dgm	control drawing
				Gepr. (020)	12.02.00	APT2000CC-0-IS, APT2000CC-H-IS
				Freigegeben (FGL)	22.02.00	
				Schlüsselwort nach DIN 34 beachten		Zeichnungsnummer
3	product improvement	CSA	11.07.00	dgm		194.220-200
2	Fußnote E/max in 1		30.06.00	dgm		
1	Entity Parameters		05.06.00	dgm		
Nr.	AC	Datum	Bearbeiter/FGL		ERN	Ungültig ab:
						Ersetzt durch:

Glossary

Conductance Conductance $G [S] = 1 / R [\Omega]$

Conductivity Conductivity $\chi [S/cm] = G [S] \cdot c [1/cm]$

Conductivity sensor 2-electrode sensors can be connected. The cell constant of the sensor in use must be entered or be determined using a calibration solution taking account of the temperature.
A special device variant (APT2000TC) is provided for electrodeless sensors.

Salinity Salt content of water
Measure of the total dissolved salts in a solution or in seawater [%]

Temperature coefficient With temperature compensation activated, the measured value is calculated to the value at the reference temperature (25 °C) using the temperature coefficient.

Temperature compensation Calculates the measured conductivity value for a reference temperature.

Index

22 mA signal for error message 47

A

Accessories 73
Alarm 29, 50
Assembly 14
Attenuation 45
Audit Trail 9
Automatic device self-test 27

C

Cable preparation 20
Calibration 54
 by input of cell constant 56
 Calibration solutions 78
 Display of calibration data 63
 Product calibration 60
 Temp probe adjustment 62
 with calibration solution 58
Cleaning 64
Concentration 37, 39
 Process solutions 39
Concentration curves 80
 -01- Sodium chloride solution NaCl 80
 -02- Hydrochloric acid HCl 81
 -03- Sodium hydroxide solution NaOH 82
 -04- Sulphuric acid H₂SO₄ 83
 -05- Nitric acid HNO₃ 84
Conductivity sensor 88
 Selecting 35
 Sensor monitoring 27
Configuration 30
 Alarm settings 50

Current output	34
Factory settings	32
Individual settings	33
LIN characteristic	40
LOG characteristic	42
Measured variable	36
Menu structure	31
Output current during Error and HOLD	46
Overview	32
Process solutions for concentration	38
Sensor type	34
Temperature compensation	48
Time constant of output filter	44
Conformity with FDA 21 CFR Part 11	9
Connection	6, 18, 22
Control / Installation Drawing	86
Current output	29
Configuration	34
Display of output currents	63

D

Diagnostics	63-64
Display	25
Division 2 wiring	85

E

EC Declaration of Conformity	8
EC-Type-Examination Certificate	10
Electronic Signature	9
Error messages	66
Display of last error message	63
Explosion protection	77
Cleaning in a hazardous location	6

Index

F

FM Control Drawing	86
Division 2 wiring	85

G

GainCheck device self test	27
Glossary	89

H

HART communication	29
Hold mode	28
LED in HOLD mode	51
Output signal during HOLD	47

I

Installation	18
Cable preparation	20
Intended use	7

K

Keypad	26
--------------	----

L

Loop current	29, 76
--------------------	--------

M

Measurement range over 3 decades	43
Mounting plan	15

O

Operating states	65
Output filter	45

P

Packing list	14
Panel mounting	17
Panel-mount kit	17, 73
Passcodes according to FDA 21 CFR Part 11	52
Pipe mounting	16
Pipe-mount kit	16, 73
Power supply	6, 18
Power supply unit	6
Product line	73
Protective hood	16, 73

S

Safety functions	27-28
Safety information	5
Installation	6
Salinity	37, 89
Sensocheck	27, 68
ON / OFF	51
Sensoface	27, 68
Sensor monitor	63
Specifications	74

T

Temperature compensation	48
Temperature probe adjustment	62
Terminal assignments	19
Terminals	19
Trademarks	7

Index

U

User interface	24
USP	37, 70
Configuration	70

W

Warranty	2
Wiring example	23

Passcodes (Factory settings)

The passcodes allow fast access to the functions

Calibration

Key+passcode	Description	Page
<input type="text" value="CAL"/> 0000	Cal Info	63
<input type="text" value="CAL"/> 1100	Calibration: Entry of cell constant	56
<input type="text" value="CAL"/> 0110	Calibration: Calibration solution	58
<input type="text" value="CAL"/> 1105	Product calibration	60
<input type="text" value="CAL"/> 1015	Temp probe adjustment	62

Configuration

Key+passcode	Description	Page
<input type="text" value="CONF"/> 0000	Error Info Display last error and erase	66
<input type="text" value="CONF"/> 1200	Configuration	30
<input type="text" value="CONF"/> 2222	Sensor monitor Display resistance and temp	63
<input type="text" value="CONF"/> 5555	Current source Specify output current	64

Passcode editor

Key+passcode	Description	Page
<input type="text" value="CONF"/> 1989	Administrator passcode Changing the passcodes	52

Free Manuals Download Website

<http://myh66.com>

<http://usermanuals.us>

<http://www.somanuals.com>

<http://www.4manuals.cc>

<http://www.manual-lib.com>

<http://www.404manual.com>

<http://www.luxmanual.com>

<http://aubethermostatmanual.com>

Golf course search by state

<http://golfingnear.com>

Email search by domain

<http://emailbydomain.com>

Auto manuals search

<http://auto.somanuals.com>

TV manuals search

<http://tv.somanuals.com>