

GIANTEX[®]

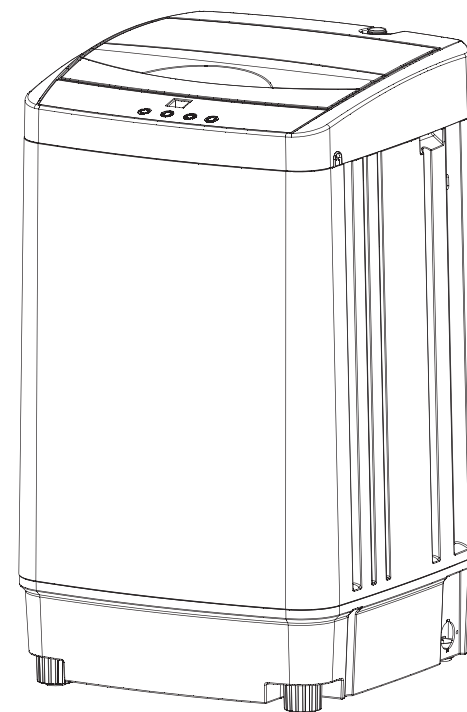

USER'S MANUAL

Fully Automatic Washing Machine EP24403

THIS INSTRUCTION BOOKLET CONTAINS **IMPORTANT** SAFETY INFORMATION. PLEASE READ AND KEEP FOR FUTURE REFERENCE.

Please give us a chance to make it right and do better!

Contact our friendly customer service department for help first.

Replacements for missing or damaged parts will be shipped ASAP!

Follow Costway

Visit us: www.costway.com



Contact Us!

Do NOT return this item.

Contact our friendly customer service department for help first.



Before You Start

- ⚠ Please read all instructions carefully.
- ⚠ Retain instructions for future reference.
- ⚠ Separate and count all parts and hardware.
- ⚠ Read through each step carefully and follow the proper order.
- ⚠ We recommend that, where possible, all items are assembled near to the area in which they will be placed in use, to avoid moving the product unnecessarily once assembled.
- ⚠ Always place the product on a flat, steady and stable surface.
- ⚠ Keep all small parts and packaging materials for this product away from babies and children as they potentially pose a serious choking hazard.

Welcome to visit our website and purchase our quality products!

Your suggestions and comments for COSTWAY are really important to us!
We sincerely solicit you to go back to our shop and leave a good rating in just a simple click. It would be quite encouraging if you could kindly do so like below:

★★★★★ Great products so far

February 24, 2019
Great products so far. Fast delivery, easy setup, and working without any issues.

With your inspiring rating, COSTWAY will be more consistent to offer you EASY SHOPPING EXPERIENCE, GOOD PRODUCTS and EFFICIENT SERVICE!

US office: Fontana, California

UK office: Ipswich



- * Reward Points
- * Exclusive Customer Service
- * Personalized Recommendations
- * Permanent Shopping Cart
- * Order History

5 Star Rating



We would like to extend our heartfelt thanks to all of our customers for taking time to assemble this product and giving us valuable feedbacks.



It is most important that this instruction book should be retained with the appliance for future reference. Should the appliance be sold or transferred to another owner, or should you move house and leave the appliance, always ensure the book is supplied with the appliance in order that the new owner can get to know the functioning of the appliance and the relevant warnings. These warnings have been provided in the interest of safety. You must read them carefully before installing or using the appliance.

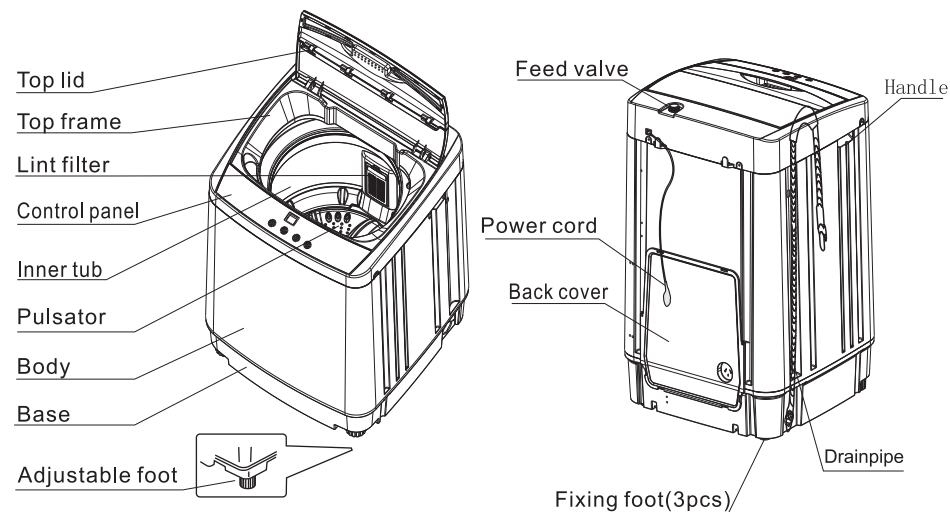

PARTS NAME



Accessories

<p>Bottom cover (1pc)</p>	<p>Water inlet hose (1pc)</p>	<p>Tapping screw ST4X14(8pcs)</p>

Symbol definition

Warning symbols 	Pay special attention to the warning symbols. There may be serious risks to personal body safety or damages to the washing machine if not follow.
Forbidden symbols 	Please stop doing the contents with this symbol, otherwise it will damage the appliance or injure your personal body.

SPECIFICATIONS

Model	EP24403
Rated voltage and frequency	120V~ 60Hz
Rated capacity of wash and spin	12LBS (dry laundries weight)
Water level/water volume (about)	1 / 2 3 L 2 / 2 6 L 3 / 2 9 L 4 / 3 3 L 5 / 3 6 L 6 / 3 9 L 7 / 4 2 L 8 / 4 6 L
Inlet pressure	0.03MPa~0.85MPa
Rated input power	Wash: 310W spin: 250W
Weight	48.4LBS
Dimensions	W19.7in D19.8in H33.6in

PARTS NAME

1. Give an alarm

Display	Explanation	Settlement
E0	The top lid is opened when preset is started	Close the top lid and clear up the alarm

USE OF DETERGENT

- Put the detergent powder into the tub as the right figure.
- Then colose the wash lid.
- We suggest use low sudsing detergent powder

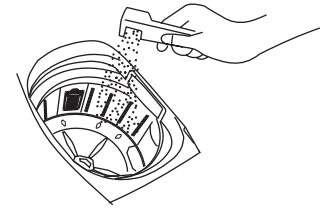

How to use the washing powder

- Dissolve in the machine directly (not suitable for delay program)
 1. Low water level.
 2. Add the washing powder, and run for 30 seconds to dissolve it completely.
 3. Put laundries in, select suitable water level.
- The instant dissolving of the washing powder
 1. Prepare warm water of 86°F in a container.
 2. Pour the powder while stirring to fully dissolve it.
- The washing powder is more prone to pollute the laundries than the detergent, therefore, please use it with proper quantity.
- Washing powder with poor quality or not used for a long period may get blocked, please clean the detergent box in time.

How to use bleach

- Fill water to the selected level, dilute the bleach in the container, and pour it slowly into the washing tub.
- Do not use bleach for colored or figured laundries as they are prone to lose colors.
- Do not put bleach to laundries directly.
- Refer to the manual for the usage and quantity of the bleach.
- Please dissolve powder bleach before use.

How to use softener

- Put the softener into softener box before the machine run(turn inner tub to find the softener box at the balance ring as below shown in the figure), please turn the inner tub have the softener box at right side or left side, and then put into the softener. The softener will auto put into inner tub when the machine rinsing wash.
- After put into softener, please don't lay up too long time, otherwise the softener will solidify, and result in the softener can not smoothly flow. When the machine spin, please don't press "start/pause" button, otherwise the softener will put into machine at early, and affect the softener effect.
- When choose rinse/spin program or above two times of rinse/spin, please don't use softener, otherwise the softener will put into machine early and affect the softener effect.
- When use the high concentration softener, please deliquate it before use.

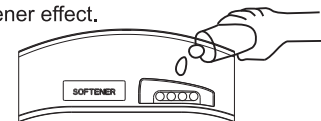

- For the quantity of the concentrated washing powder, please refer to its manual.
- Remarks: avoid splashing of water and waste of washing powder, water level should not be too high if laundries are too small.

LOAD LAUNDRIES



- The capacity of washing and spinning of the machine refer to the largest weight of the standard laundries under dry condition .Washing quantity shall be lower than the rated capacity.
- Different thickness, size and type of the laundries will influence the actual washing capacity. It is suitable that the laundries can be turned round normally during washing.
- Don't select high water level when laundries are less than 2.2LBS to avoid water splashing.

Reference weight of the laundries

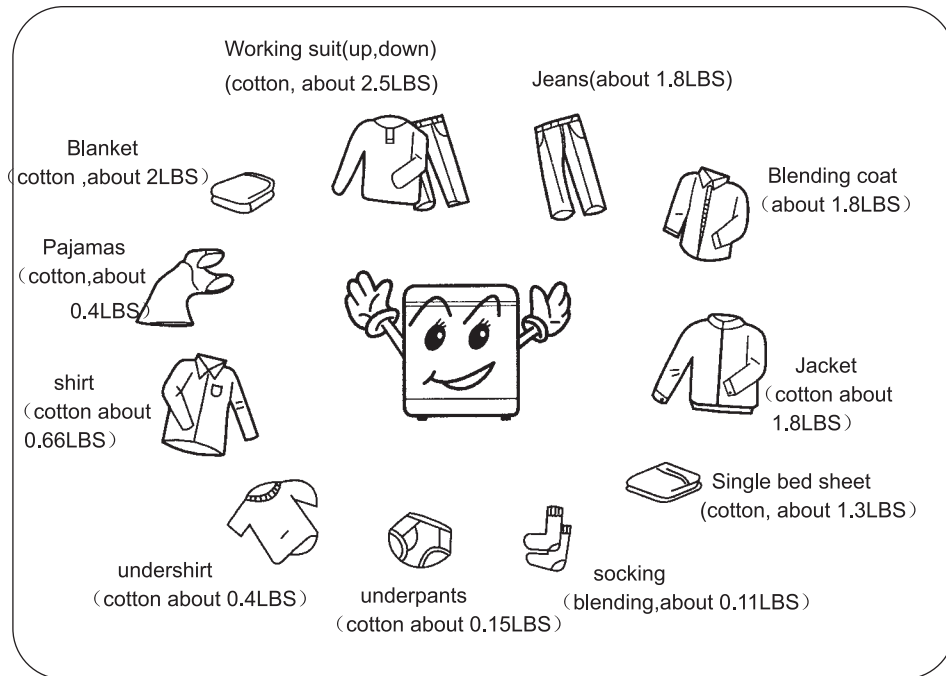

E1	After draining 5 minutes, it still does not reach to water level	Open top lid, according to before troubleshooting and settlement to settle it ,then close the top lid and clear up the alarm.
E2	The top lid is open when spinning	Close the top lid and clear up the alarm
E3	Spin does not balance	Open the top lid ,make the laundries place equally, then close it and clear up the alarm
E4	After inlet 50 minutes still not reach to setting water leve	Open top lid, according to before troubleshooting and settlement to settle it. Then close the tip lid and clear up the alarm
E5	The top lid is opened after setting child-lock	Close the top lid and clear up the alarm
E6	The water level is more than overflowing water level.	Drain the water until the water level reach the highest water level.
E7	The input and output of the memory is abnormal.	Close the top lid and clear up the alarm
F1	Water level sensor is wrong	Cut the power supply and call the technicians

2. Imbalance adjustment

During spinning, if the laundries are not placed equally in the tub, it would cause violent vibration. This machine has imbalance adjustment function, and the vibration testing system will supervise the running. Once vibration is beyond certain level, the adjustment system will start automatically to adjust the imbalance.

3. Power supply is cut off automatically

- (1) If do not press START/PAUSE in 10 minutes after pressing POWER, power supply will cut off automatically.
- (2) Washing finished, power supply will cut off automatically .

4. Child lock function

When the machine running, press the buttons of “water level/spin” and “program/delay” at the same time 3 seconds to set child lock function, and then the LED display “CL”, press the buttons of “water level/spin” and “program/delay” at the same time above 3 seconds again to cancel the child lock. And the machine will back to display the remain time. Once set the child lock function, all buttons are locked(including power button). If the top door is opened when the machine is running, the machine will stop to run and error alarm, the LED display “E5”

and flash, if the door is closed within 5 mins after opening, the machine will stop error alarm and continue to work. If the machine door is opened more than 5 mins, and the machine will drain water until recover water level. During this time, the error alarm will sound 10 seconds every 10 mins to warn the machine have an accident, at then, close the top door is not useful.

5. One key spin function

When power on, and press “power on/off”, the machine will be standby(not press “start/pause”), long time press “water level/spin” above 3 seconds, the one key spin function will start, and the spin program will run as “09”, that is fast to switch for “spin” program and start to run.

CAUTIONS

Please insert the plug into the power socket with rated voltage 110V A/C.

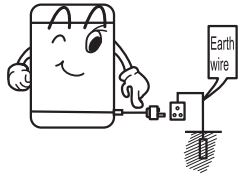

Always unplug the appliance and turn off the water when the power is cut, moving or cleaning the washing machine, or it is not in use. Do not insert or pull off the plug with wet hand.

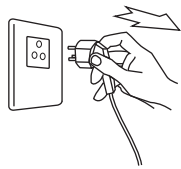

Do not make the electric cable bended, stretched, twisted, strapped or changed, pressed or nipped. If the electric cable or plug is damaged or the socket becomes loose, they must be repaired or changed by our appointed repair stations or the professionals of our post-sale service department to avoid danger. The pin of the plug must remain clean. Please clean it carefully with dry cloth if it is dirty.

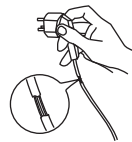

Don't install the washing machine in bathroom or damp places.. Do not wash the machine with water, do not put wet clothes on the control panel film.

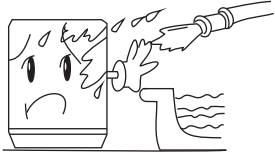

Do not use water hotter than 122°F.



If the machine is situated on a carpeted floor, please adjust the feet in order to allow air to circulate freely.

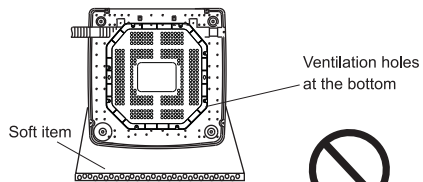

Do not wash raincoat, bike cover, feather dress and such waterproof laundries, which will make the washing machine abnormal vibrations during spinning.



Do not share the same socket with other electric appliances. Do not use the damaged plug or loose socket.

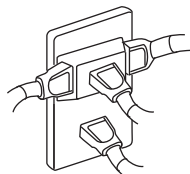

PREPARATION BEFORE OPERATION

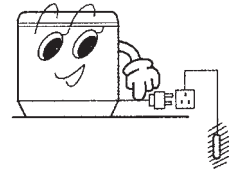

Preparation before washing

1. Connect the inlet hose and open the tap.
2. This appliance must be earthed. Confirm the socket is earthed reliably and insert the power plug. The earth terminal should not link to gas pipeline, tap pipeline etc.
3. Put up the drainpipe.



Warning: the temperature of the water should less than 122°F !

Before washing the laundries, please pay attention to the followings:

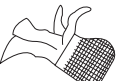
<p>Make sure if there is special requirements for the laundries</p>	<p>Before washing, empty all pockets of small objects which may have been left inside (coins, keys, screws etc.) As these could damage the drain pump.</p>	<p>Knot the long band, fasten the buttons and close the zippers.</p>	<p>Do not overload the machine. Load the laundry loosely alternating large items with small ones.</p>	<p>Sort the laundry according to the type of fabric, color-fastness and how dirty it is. Put thin laundries, woolens and such prone to wear and tear laundries into washing bag.</p>
<p>A. Make sure the laundries are washable.</p> <p>B. It is essential to wash new colored items separately when washing for the first time. White items should not be washed with colored items.</p> <p>C. Please immerge the non-absorbable laundries by hand.</p> <p>D. Some stains such as fruit, wine, grass, rust etc. are difficult to remove and should be treated before washing with specific products, which can be found in most household shops. In some cases it may help to soak the stain before washing with a special pre-soak product or biological detergent.</p> <p>E. Overturn the nap fabric and long floss laundries before putting them into the machine.</p> <p>F. Do not put the laundries polluted by chemicals into the machine directly.</p> <p>G. Very small item(handkerchiefs, ribbons, socks etc) should be washed in a washing bag or a pillow case.</p>				



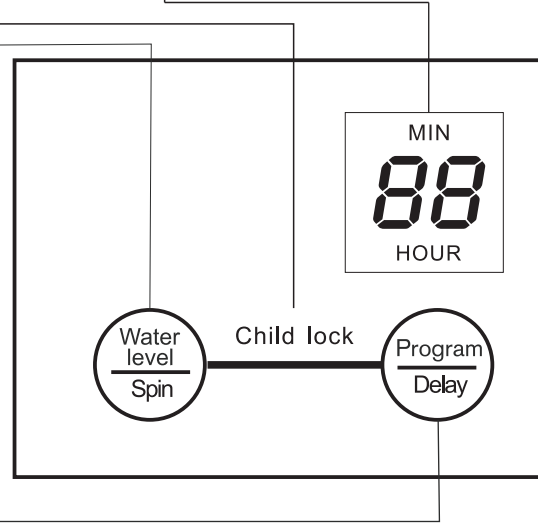

- When use the machine, press the buttons of “water level/spin” and “program/delay” at the same time above 3 seconds to set child lock, press the buttons of “water level/spin” and “program/delay” at the same time above 3 seconds again to cancel the child lock.

- Under DELAY function, before washing, the digital timer shows preset time, unit is HOUR.
- When washing, the digital timer shows the rest time of washing, unit is MINUTES.
- When trouble encountered, the digital time shows trouble code.

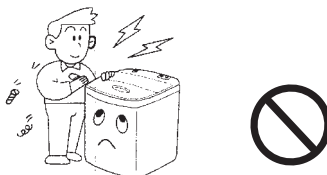
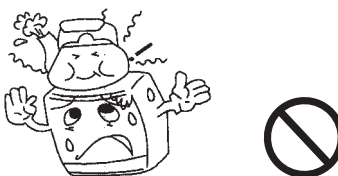

- At the beginning of start, press Water level/Spin to select water level, you can select appropriate water level. According to your laundries quantity. 1-2 is low water level, 3-5 is middle water level, 6-8 is high water level.
- During wash (including rinse), if need to add water, press Water level/Spin button to add water, un-press will stop adding. Or pause the washing machine and press Water level/Spin to select higher water level, then press Start/Pause button, The washing machine will add the water to setting level automatically and continue working. If your resetting water level is lower than present water level, the lower water Level will valid in next water inlet.
- At the power on initial status, long press the button “water level/spin” above 3 seconds, the machine will run spin function. When use the machine, the top door should be closed. Otherwise, when the machine start to spin, the machine will stop to run and error alarm.

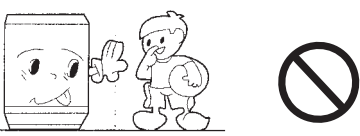
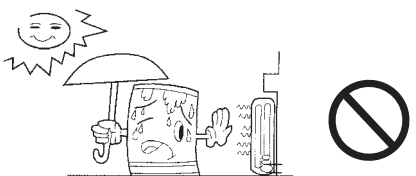
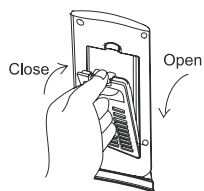
- When the machine power on, press “program/delay” button to choose the below 10 program. When choose the program are Normal, standard, fast, blanket, soak, and the LED will display as 01,02,03,04,05. When choose the program are wash, wash&rinse, rinse&spin, spin, tub air dry, and the LED will display as 06,07,08,09,10.
- At the power on initial status, long press the button “program/delay” above 3 seconds to set 2-24hours delay wash. Press button one more time to add one more hour.
- If want to cancel delay wash, press “power on/off” button to back standby status.

<p>Do not put hands into the working machine. It is dangerous even if the speed is very slow. Take special care of the children, and forbid them to climb on the washing machine.</p> 	<p>It is dangerous to alter the specifications or attempt to modify this product in any way.</p> 
<p>Do not overload the appliance or put any hot goods (such as the kettle with hot water) on the washing machine.</p> 	<p>Garments which have been in contact with volatile petroleum products should not be machine washed.</p> 
<p>This appliance is not intended for use by persons (including children) with reduced physical, sensory or mental capabilities, or lack of experience and knowledge, unless they have been given supervision or instruction concerning use of the appliance by a person responsible for their safety. Children should be supervised to ensure that they do not play with the appliance.</p> 	<p>Keep the appliance away from direct sunlight and heat sources like the heater.</p> 
<p>To prevent the lint from blocking cascade outlet during washing, please keep the lint filter in good condition, install it to proper position and clean it in time.</p> 	<p>Any objects such as coins, safety pins, nails, screws, stones or any other hard, sharp material can cause extensive damage and must not be placed into the machine.</p>  <ul style="list-style-type: none"> • Before washing, please ensure the tap is open and the inlet hose is installed properly. • It is suggested to use low foam washing powder.

Settlement

Insert the plug tightly Check the socket or change to another socket Press power switch Check power supply	Restart when water supply is resumed Open the tap Clean the filter according to before "clean inlet gate"
Install the inlet hose again Tighten the connector of the machine	The machine is adjusting automatically
The height of the drainpipe should be less than 3.9ft Straighten or clean the drainpipe	Close the top lid Close the top lid
Normal	Normal

Notes : If there is still a fault after the above checks, please pull out the plug and contact the seller right away.
It is dangerous to repair this product by yourself.

PARTS NAME

Before contacting the technicians, please make the following checks:

Phenomena	Possible reason
Control panel has no any display	Plug is not inserted tightly No electricity in the socket Power switch is not turned on Power supply is cut off
Inlet hose leaks	Inlet hose connector(connecting with the tap)is not fixed tightly Inlet hose and washing machine connector is loose
It does not drain	Water outlet of drainpipe is higer than 3.9ft Drainpipe is bended or get blocked
It does not inlet	No water supply Tap is not open Inlet hose gets blocked
Spin stops and begins to inlet during spin program	Laundries is too much or too little or the Machine is not place stably
Press the program button to select SPIN, but It does not spin	Do not close the top lid when drain is finished Open up the top lid when start drain
The spin is intermittent when spin starts	Balance the laundries to reach to the best spin effect
First time to use, some water flows from the drain hose	The remaining water when the factory make test

- After select program, processand waterlevel, press this button to start.
- Press this button to pause during working, press again will rework.

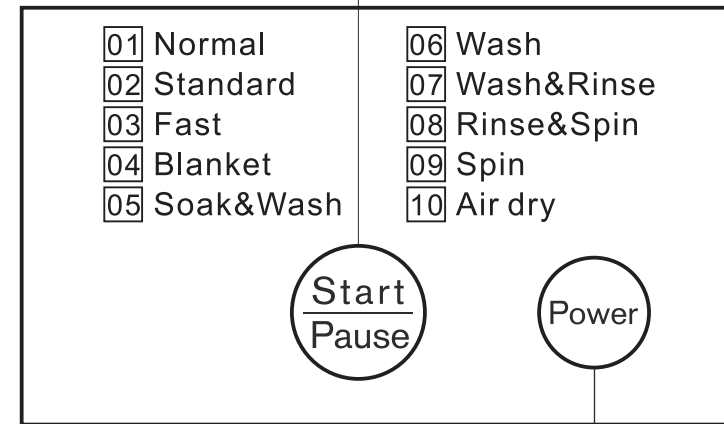

- To control the washing machine is in working state or waiting state.

CONTROL PANEL INSTRUCTION

Mode and meaning of the indicator light

WATER INLET INSTALLATION

Tap selection

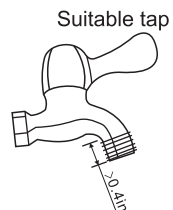

The front end should be longer than 0.4in . The tap exit end face should be flat and smooth, if not file it to avoid leakage

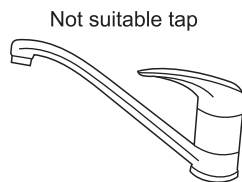

Check the connection between inlet hose connector and the tap

1. Swing the inlet hose gently to confirm if it is fastened.
2. After installation, open the tap and check if it leaks.
3. Do not bend the inlet hose with overstrain.
4. Before each usage, check the connection between inlet hose connector and the tap. Make sure they are firmly fitted to prevent dropping from improper installation position.

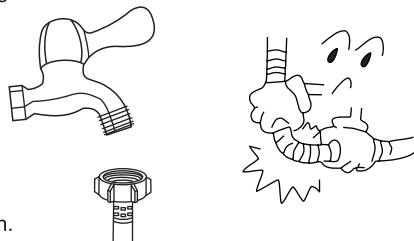

Connect the inlet hose with the washing machine

1. Do not take off the water absorption cushion. Please check if the cushion is dropped or damaged before each usage. If it is, contact the seller immediately.
2. Put the inlet hose nut on the inlet valve connector.
3. Fasten the inlet hose nut and swing it gently to make sure it is suitable.

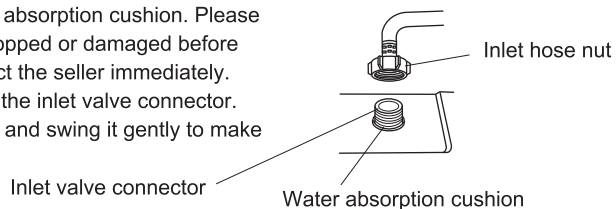

PARTS NAME

Please install and adjust the machine according to the requirements of the manual. It is very important to your safety and correct operation.

Unpacking

- Unpack the carton and take out the bottom panel.
- Open the top lid of washing machine and take out all of the accessories.
- Remove all wrappers, including the polystyrene base.
- You are advised to keep all the packaging for reuse in case the machine is to be transported again.

Installing the bottom cover

- As the right photo, put down the machine from side, put down the machine on some soft thing, please let the remarkable face outside, the arrow direction is machine front side.
- Align the screw hole between bottom and bottom cover, use the appendix screw to fasten the bottom cover.

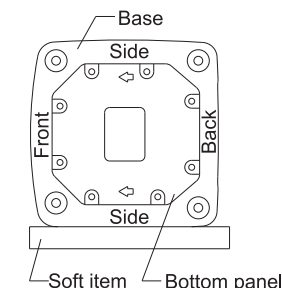

The distance between the washing machine and the wall should be more than 50mm, and the maximum allowed angle of the shank base of the machine is 1°. The slanting or rough ground may cause operating stopped or unstable, please adjust it with the following methods:

- Make it horizontal
Use a tied thread with plumb to check if it is horizontal.

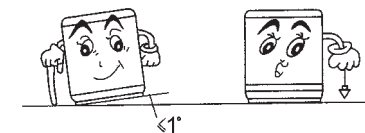

- Adjust the adjustable foot
1. Lift up the adjustable foot gently, loose the adjustable nut and twist the adjustable foot.

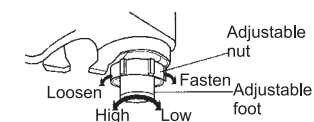

- 2. Fasten the nut after adjustment.

HOW TO USE DRAINPIPE

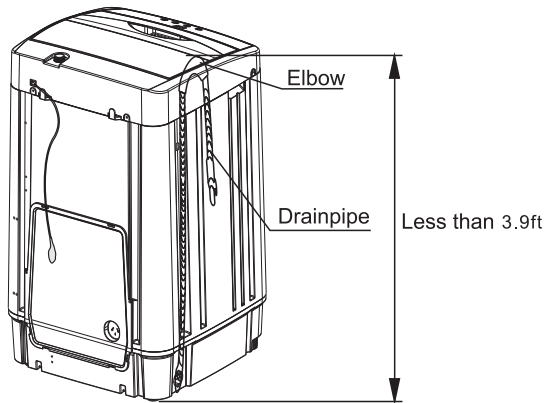

1. the drainpipe must be hanged during use, the height is not more than 3.9ft to avoid leakage or stop, if drain a long time, the machine will stop running.
2. You can adjust the situation of the elbow bend pipe to change the height of the drainpipe.
3. Do not extrude the drainpipe to ensue drain smoothly.

MAINTENANCE

Maintenance methods

After the end of the programme

- The machine stops automatically ,and music buzzer will remind you to take out the laundries or start again.
- Once you have finished using the machine, you are advised to unplug it and turn off the water taps to avoid unexpected leak or fire.

External cleaning

Clean the exterior cabinet of the appliance with soft cloth. Do not use cleanser, volatile chemical materials to clean the machine, which will damage plastic parts and the surface.



Clean inlet gate

It is possible that the inlet filter net can be blocked by the dust, please clean it according to the follow steps:

1. Close the tap and turn on the power switch.
2. Start the washing machine for 5 seconds(make the water in the inlet hose flows to the tub),and cut off the powersupply.
3. Pull off the inlet hose, remove and clean the inlet valve and the inlet net, and install again.

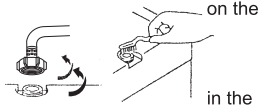

Clean the lint filter

- It is necessary to use lint filter during washing.
- After washing, please clean the lint filter in time.

Clean the lint filter according to the following steps:

1. Pull out the lint filter .(see Illustration 1)
2. Open the lint filter and wash it.(see Illustration 2)
3. Close the lint filter and install it to proper position.

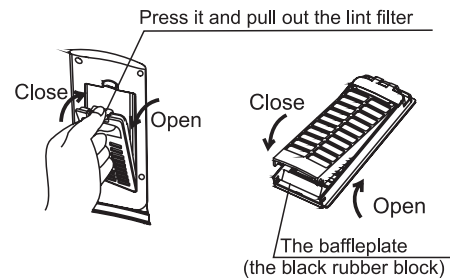

Illustration 1

Illustration 2

1. Once you have using the machine, you are advised to turn off the water taps.(if necessary, pull out the inlet hose)
2. Do not keep water in tub for a long time. When washing is finished , drain it right away.
3. Once you have finished using the machine, you are advised to unplug it.
4. Put the electric cable and the drain hose in order.
5. Wipe the water on the surface and in tub with soft cloth and keep the top lid opening for a while. It helps to prevent mould and stagnant smells forming inside the appliance.

If the water in the inner tub has possibility to freeze,please do like below:

1. In winter, if remaining water freeze can cause the washing machine trouble, please take off the water inlet hose and drain out the water in the hose and inner tub.
2. If the water freeze, please don't operate the washing machine. Put 104° hot water in the tub, the hot water should submerge the pulsator, after a few minutes, rotate the pulsator by hand gently, then you can operate the washing machine.

OPERATION STEPS

1. Press power switch, put through power, the machine is in state of beginning:
2. Press "program/Delay"button to select proper program.
3. Select appropriate water level according to your laundries quantity.
4. At the power on initial status, if want to choose delay wash, long press the button "program/delay" above 3 seconds to set delay wash time. Press button one time, and the flash light will flash, and the display figure is stand for program over time. If want to cancel delay wash, press "power on/off" button to back standby status.
5. At the power on initial status, long press the button "water level/spin" above 3 seconds to choose spin function.
6. When close the top door and press "start/pause" button to run the machine, at the same time press "water level/spin" and "program/delay" above 3 seconds to set child lock, press the buttons of "water level/spin" and "program/delay" at the same time above 3 seconds again to cancel the child lock. Once set the child lock function, if open the top door, the machine will stop run and error alarm.
7. At the beginning of start, if need to select air-dry, press"Program/Delay" button to select "Air dry", When the air dry function is over, the washing machine will be in waiting state.
8. Close the top lid, press Start/Pause, the washing machine is working.
9. When the washing is finished, buzzer alarm, power supply cut off automatically.

Free Manuals Download Website

<http://myh66.com>

<http://usermanuals.us>

<http://www.somanuals.com>

<http://www.4manuals.cc>

<http://www.manual-lib.com>

<http://www.404manual.com>

<http://www.luxmanual.com>

<http://aubethermostatmanual.com>

Golf course search by state

<http://golfingnear.com>

Email search by domain

<http://emailbydomain.com>

Auto manuals search

<http://auto.somanuals.com>

TV manuals search

<http://tv.somanuals.com>