



INSTALLATION AND OPERATING INSTRUCTIONS

Electric Griddles

Models: EG-24i, -36i & -48i

IMPORTANT FOR FUTURE REFERENCE

Please complete this information and retain this manual for the life of the equipment. For Warranty Service and/or Parts, this information is required.

Model Number

Serial Number

Date Purchased

CONTENTS

General Information... 2
Safety Precautions ... 3
Specifications & Dimensions ... 4
Installation... 4
Equipment Preparation ... 5
Operator Seasoning ... 5
Cleaning... 5
Suggested Temperatures & Times for Griddling... 6
Parts List... 7
Exploded View ... 8
Wiring Diagrams ... 9
Warranty ... 12



WARNING: For your safety do not store or use gasoline or other flammable vapors or liquids in the vicinity of this or any other appliance. Keep the area free and clear of combustibles. (See ANZI Z83.14B, 1991)



WARNING: Improper installation, operation, service or maintenance can cause property damage, injury or death. Read and understand these instructions thoroughly before positioning, installing, maintaining or servicing this equipment.



P/N 882205

APW WYOTT Foodservice Equipment Company

P.O. Box 1829
Cheyenne, WY 82003

+1 (307) 634-5801 Phone
+1 (307) 637-8071 Fax

+1 (800) 752-0863 Toll Free
www.apwwyott.com

GENERAL INFORMATION

THIS MANUAL SHOULD BE RETAINED FOR FUTURE REFERENCE



CAUTION: These models are designed, built, and sold for commercial use. If these models are positioned so the general public can use the equipment, make sure that cautions, warnings, and operating instructions are clearly posted near each unit so that anyone using the equipment will use it correctly and not injure themselves or harm the equipment.



WARNING: Improper installation, operation, service or maintenance can cause property damage, injury or death. Read and understand these instructions thoroughly before positioning, installing, maintaining or servicing this equipment.



WARNING: Install per the spacing requirements listed in the installation section of this manual. We strongly recommend having a competent professional install the equipment. A licensed electrician should make the electrical connections and connect power to the unit. Local codes should always be used when connecting these units to electrical power. In the absence of local codes, use the latest version of the National Electrical Code.



WARNING: For your safety do not store or use gasoline or other flammable vapors or liquids in the vicinity of this or any other appliance. Keep the area free and clear of combustibles. (See ANZI Z83.14B, 1991)



WARNING: Check the data plate on this unit before installation. Connect the unit only to the voltage and frequency listed on the data plate. Connect only to 1 or 3 phase as listed on the data plate.



WARNING: This product is intended for commercial use only. Not for household use. Retain this manual for future reference. Oven must be kept clear of combustibles at all times.



WARNING: SHOCK HAZARD - Do not open any panels that require the use of tools.



WARNING: Electrical and grounding connections must comply with the applicable portions of the national electrical code and/or other local electrical codes.



WARNING: Disconnect device from electrical power supply and place a Tag Out-Lockout on the power plug, indicating that you are working on the circuit.



NOTICE: This product is intended for commercial use only. Not for household use.





NOTICE: The unit, when installed, must be electrically grounded and comply with local codes, or in the absence of local codes, with the national electrical code ANSI/NFPA70-latest edition. Canadian installation must comply with CSA-STANDARD C.22.2 Number 0 M1982 General Requirements-Canadian Electrical Code Part II, 109-M1981- Commercial Cooking Appliances.



NOTICE: Local codes regarding installation vary greatly from one area to another. The National Fire Protection Association, Inc. states in its NFPA96 latest edition that local codes are “Authority Having Jurisdiction” when it comes to requirement for installation of equipment. Therefore, installation should comply with all local codes.



WARNING: An earthing cable must connect the appliance to all other units in the complete installation and from there to an independent earth connection.



NOTICE: Maintenance and repair should be handled by a factory authorized agent. Before doing any maintenance or repair, contact APW Wyott.



SAFETY PRECAUTIONS

Before installing and operating this equipment be sure everyone involved in its operation is fully trained and is aware of all precautions. Accidents and problems can result by a failure to follow fundamental rules and precautions.

The following words and symbols, found in this manual, alert you to hazards to the operator, service personnel or the equipment. The words are defined as follows:



DANGER: This symbol warns of imminent hazard which will result in serious injury or death.



WARNING: This symbol refers to a potential hazard or unsafe practice, which could result in serious injury or death.



CAUTION: This symbol refers to a potential hazard or unsafe practice, which may result in minor or moderate injury or product or property damage.



NOTICE: This symbol refers to information that needs special attention or must be fully understood even though not dangerous.



IMMEDIATELY INSPECT FOR SHIPPING DAMAGE

All containers should be examined for damage before and during unloading. The freight carrier has assumed responsibility for its safe transit and delivery. If equipment is received damaged, either apparent or concealed, a claim must be made with the delivering carrier.

- A) Apparent damage or loss must be noted on the freight bill at the time of delivery. It must then be signed by the carrier representative (Driver). If this is not done, the carrier may refuse the claim. The carrier can supply the necessary forms.

B) Concealed damage or loss if not apparent until after equipment is uncrated, a request for inspection must be made to the carrier within 15 days. The carrier should arrange an inspection. Be certain to hold all contents and packaging material.

Installation and start-up should be performed by a qualified installer who thoroughly read, understands and follows these instructions.

If you have questions concerning the installation, operation, maintenance or service of this product, write Technical Service Department APW/Wyott Foodservice Equipment Company, P.O. Box 1829, Cheyenne, WY 82003.

Congratulations on your purchase of APW Wyott commercial cooking or refrigeration equipment. **APW Wyott** takes pride in the design and quality of our products. When used as intended and with proper care and maintenance, you will experience years of reliable operation from this equipment. To ensure best results, it is important that you read and follow the instructions in this manual carefully.

LOCATION OF DATA PLATE

The data plate is located on the front panel.

SPECIFICATIONS AND DIMENSIONS

Electrical

EG-24I,	208/240 Volt,	50/60 Hz,	1 Ph,	32.5/37.5 Amps
EG-36I,	208/240 Volt,	50/60 Hz,	1 Ph,	48.7/56.3 Amps
EG-48I,	208/240 Volt,	50/60 Hz,	1 Ph,	65/75 Amps

Dimensions

Overall Dimensions with 4" Legs



Ship Weight

EG-24I	15-1/2"H x 25-3/4"D x 24"W	EG-24I	180 lbs
EG-36I	15-1/2"H x 25-3/4"D x 36" W	EG-36I	267 lbs
EG-48I	15-1/2"H x 25-3/4"D x 48"W	EG-48I	342 lbs

INSTALLATION

Always clean equipment thoroughly before the first use. Check rating label for your model designation and electrical rating. For best results, use stainless steel countertops. Attach legs to units.

Uncrate the griddle and place it in the approximate operation location. Make sure no parts are discarded with crating material. Remove the bottom cover for wiring junction box access at the back of the griddle.

 **WARNING:** This device should be safely and adequately grounded in accordance with local codes, or in the absence of local codes, with the National Electrical code, ANSI/NFPA 70, Latest Edition to protect the user from electrical shock. It requires a grounded system and a dedicated circuit, protected by a fuse or circuit breaker of proper size and rating. Canadian installation must comply with the Canadian Electrical Code, CSA C22.2, as applicable. 

This griddle is wired for 208 volt or 230 volt service. Proper installation should comply with the attached rating plate containing model number, serial number, voltage and amperage. Supply power wiring through rear electrical knock-out to terminal block in junction box according to the National Electrical Code. Test for proper voltage supply. Return the bottom cover and mounting screws). Screw the legs into the permanently fastened nuts on four corners of the unit.

Set the griddle upright in the operating location.

Leveling: a slight incline from the front to the back may be desired to eliminate standing oil. Adjust feet accordingly.

EQUIPMENT PREPARATION

The griddle is shipped with protective coatings of oil and/or grease. Remove the griddle plate coating just prior to its first cooking use. If the griddle is to be shut down for an extended period, put a heavy coat of clean grease back over the griddle plate.

Wipe the remaining cabinet parts down with a hot, wet cloth to remove any shipping dust and protective oil. Remove anything that may be in the grease drawer.



CAUTION: Care must be exercised not to overheat the griddle plate on initial start-up by setting the controls above normal operating temperature. Overheating may cause the plate to warp and will carbonize the grease (this will cause sticking).



OPERATING SEASONING

A new griddle surface must be seasoned to do a good cooking job. The metal surface of the griddle is porous. Food tends to get trapped in these pores and stick; therefore, it is important to "season" or "fill up" these pores with griddling "fat" before cooking on any metal surfaced griddle. Seasoning gives the surface a slick, hard finish from which the food will release easily.

To season, heat the griddle to a low (300°F to 350°F) temperature and pour on a small amount of cooking oil, about one ounce per square foot of surface. Spread the oil over the entire griddle surface with a cloth to create a thin film. Wipe off any excess oil with a cloth.

Repeat the procedure 2 to 3 times until the griddle has a slick, mirror-like surface.



CAUTION: This griddle plate is steel, but the surface is relatively soft and can be scored or dented by carelessly using a spatula. Be careful not to dent, scratch, or gouge the plate surface. Do not try to knock off loose food that may be on the spatula by tapping the corner or the edge of the spatula on the griddle surface.



CLEANING

NEVER clean any electrical unit by immersing it in water. Turn unit off and allow it to cool down before surface cleaning. Always clean equipment thoroughly before first use. Clean unit daily. Except where noted on charts: use warm, soap water. Mild cleansers and PLASTIC scouring pads may be used to remove baked on food and water scale on metal units. Unplug electrical units before cleaning or servicing. All service should be performed by an American Wyott authorized service agency.

Empty the grease drawer daily. Clean the unit regularly. A clean unit looks better, lasts longer and performs better.

KEEP GRIDDLE PLATE SURFACE CLEAN. To produce evenly cooked, perfectly browned griddle products, keep the griddle free of carbonized grease.

Carbonized grease on the surface hinders the transfer of heat from the griddle surface to food. This results in spotty browning and loss of cooking efficiency and, worst of all; carbonized grease tends to cling to the griddled foods, giving them a highly unsatisfactory and unappetizing appearance. To keep the griddle clean and operating at peak efficiency, follow these simple instructions.

AFTER EACH USE, clean the griddle with a wire brush or flexible spatula.

ONCE A DAY, thoroughly clean splash back, sides and front. Remove the grease drawer and chute, empty and wash them out in the same manner as any ordinary cooking utensil.

ONCE A WEEK, clean the griddle surface thoroughly. If necessary, use a griddle stone, wire brush or steel wool on the surface. Rub with the grain of the metal while the griddle is still warm. A detergent may be used on the plate surface to help clean it, but care must be taken to be sure the detergent is thoroughly removed. After removal of the detergent, the surface of the plate should then be covered with a thin film of oil to prevent rusting. Clean stainless steel surfaces with a damp cloth and polish with a soft, dry cloth. To remove discoloration, use a

nonabrasive cleaner. After each "weekly" type of cleaning, the griddle must be reseasoned. If the griddle usage is very high, consider going through the "weekly" cleaning procedures more often than once a week.

FACTORY OFFSET - APW GRIDDLE CONTROL

The control will come with the following offsets built in. The control will interpolate the offset for values between those shown in the adjacent chart.

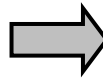

FACTORY OFFSETS	
TEMPERATURE (°F)	OFFSET (°F)
150	3
200	-10
250	-16
300	-24
350	-33
400	-39
450	-45

MANUAL TEMPERATURE ADJUSTMENT

A PCB located potentiometer allows a manual Temperature Adjustment:

- Warmer: Clockwise
- Colder: Counter-clockwise

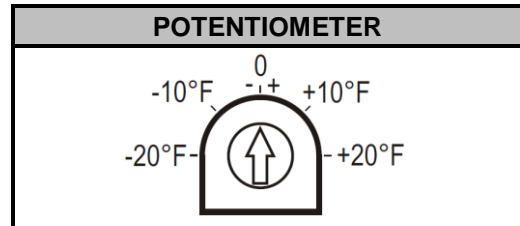
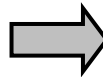

SUGGESTED TEMPERATURES AND TIMES FOR GRIDDLING

FOOD	CONTROL SETTING (FAHRENHEIT)	TIME IN MINUTES
American fried potatoes	375°	3 to 4
Bacon	350°	6
Boiled ham	375°	2
Beef tenderloin	400°	5 to 7
Canadian bacon	350°	3 to 4
Hamburgers	350°	3 to 4
Club steak	450°	3 to 5
Ham steak	400°	10
Sausage links or patties	350°	3 to 4
French toast	400°	4 to 5
Pancakes	375°	2
Scrambled eggs	300°	3 to 4
Hard fried eggs	225° to 300°	3 to 4
Soft fried eggs	250° to 300°	2 to 3
Sunny side-up eggs	225° to 300°	3 to 4

NOTE: These are only suggested griddle temperatures and cooking times. You may want to try others. For example, some restaurants are cooking hamburgers at 300°F and under.

PARTS LIST

Item	EG-24I P/N	EG-36I P/N	EG48H P/N	Description	Quantity
1	21823620	21823720	21823820	Weldment, Griddle Plate	1
2	22030010	22030015	22030020	Support, Leg	2
3	22051256	22051376	22051796	Panel, Bottom	1
4	22051253	22051373	22051493	Panel, Control	1
5	2425000	2425000	2425000	Pan, Grease	1
6	21823622	21823722	21823822	Panel, Back	1
7	22050006	22050006	22050006	Knob, Control	2(24) 3(36) 4(48)
8	8633700	8633700	8633700	Leg, HD 2" Diameter W/Foot	4
9	1514000	1514000	1514000	Light, Indicator	2(24) 3(36) 4(48)
10	1481715	1481715	1481715	Thermostat, Elec. Griddle	2(24) 3(36) 4(48)
11	1481725	1481725	1481725	Potentiometer, Elec. Griddle	2(24) 3(36) 4(48)
12	1439900	1439900	1439900	Element, Heating 240V	2(24) 3(36) 4(48)
13	22050001	22050001	22050001	Plate, Pressure	2(24) 3(36) 4(48)
14	21707000	21707000	21707000	Retainer, Insulation	12(24) 18(36) 24(48)
15	8436200	8436200	8436200	Nut, Clamping	28(24) 42(36) 56(48)
16	21820716	21820716	21820716	Side, Grease Chute	2
17	21706900	21706901	21706902	Insulation	1
18	1481000	1481000	1481000	Switch, High Limit	2(24) 3(36) 4(48)
19	1107903	1107203	1107203	Terminal Block	1
20	22050010	22050010	22050010	Assy, Bulb Clamp	2(24) 3(36) 4(48)
21	280700	280700	280700	Plate, Inspection	1
22	22051254	22051254	22051254	Panel, Side EG-H	1
23	22051254	22051254	22051254	Panel, Side L. H.	1
*24	2065847	2065847	2065847	Logo, APWWYOTT Casted	1
*25	8430500	8430500	8430500	Insert, 3/4-10 Threaded, Press In	4
26	30047501	30047501	30047501	Guide, Grease Slide -	2
27	21822036	21822036	21822036	Mount, Terminal Block	1
28	21814628	21814628	21814628	Mount, High Limit	2(24) 3(36) 4(48)
29	21823624	21823624	21823624	Mount, Thermostat	2(24) 3(36) 4(48)
*30	1481710	1481710	1481710	Probe, Electric Griddle	2(24) 3(36) 4(48)
31	8136000	8136000	8136000	Nut, Self Clinching 8-32	4
32	8196700	8196700	8196700	Screw, #10 X 3/4 AB	4
*NOT SHOWN					

WIRING DIAGRAMS

MODEL EG-24I VOLTS: 208/240 HZ: 50/60 PH: 1/3

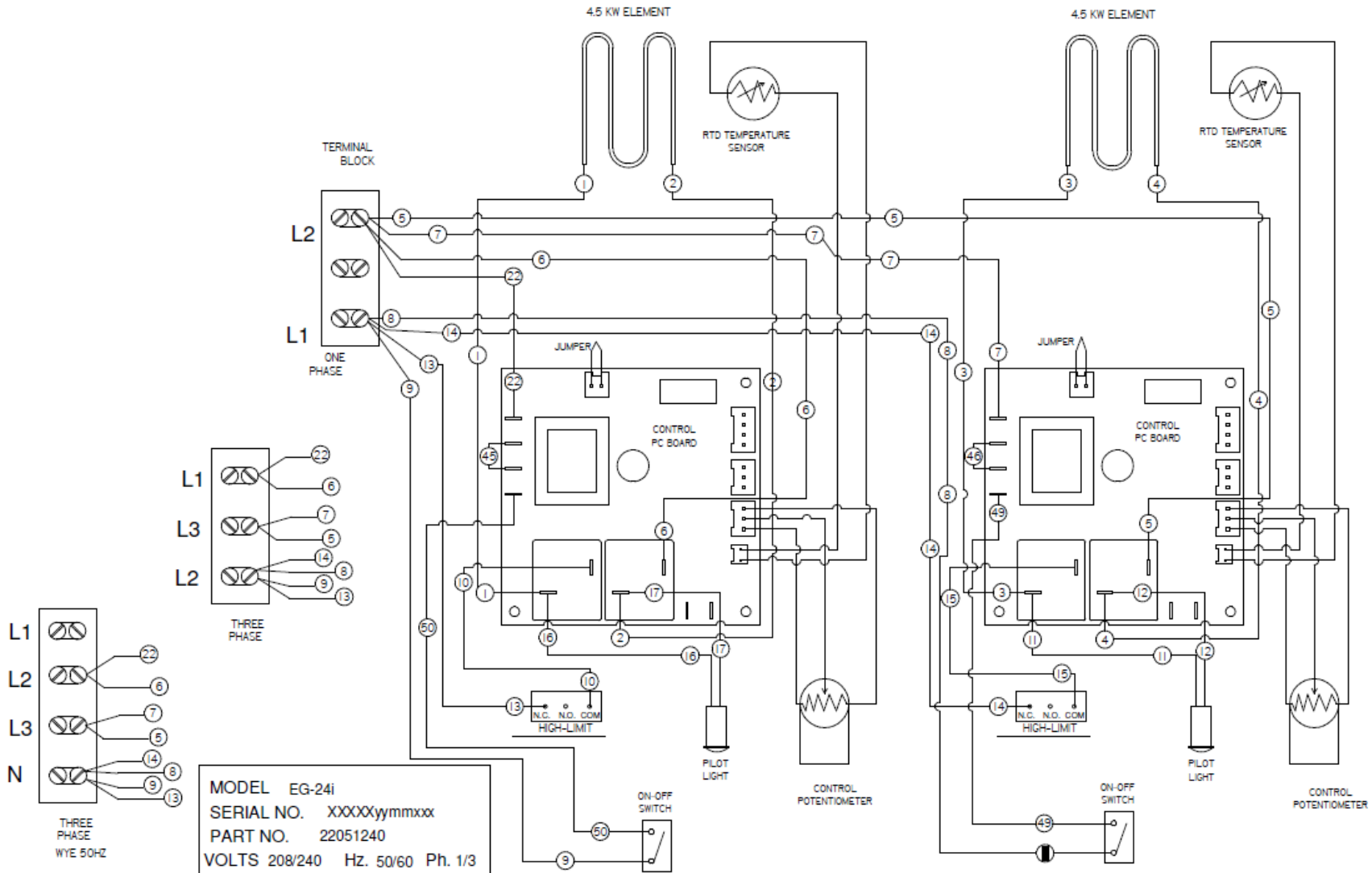

MODEL EG-24i
 SERIAL NO. XXXXyymmxxx
 PART NO. 22051240
 VOLTS 208/240 Hz. 50/60 Ph. 1/3

TOT. KW	NOMINAL AMPS/LINE			
	THREE PHASE			ONE PHASE
	L1	L2	L3	
6.75	16.3	16.3	28.1	32.5
/9.0	/18.8	/18.8	/32.5	/37.5

EG-36I VOLTS: 208/240 HZ: 50/60 PH: 1/3

MODEL EG-48H
 SERIAL NO. XXXXXyymmxxx
 PART NO. 21823800
 VOLTS 208/240 Hz. 50/60 Ph. 1/3

TOT. KW	NOMINAL AMPS/LINE			ONE PHASE
	L1	L2	L3	
13.5 /18.0	43.0 /49.6	43.0 /49.6	28.1 /32.5	65 /75

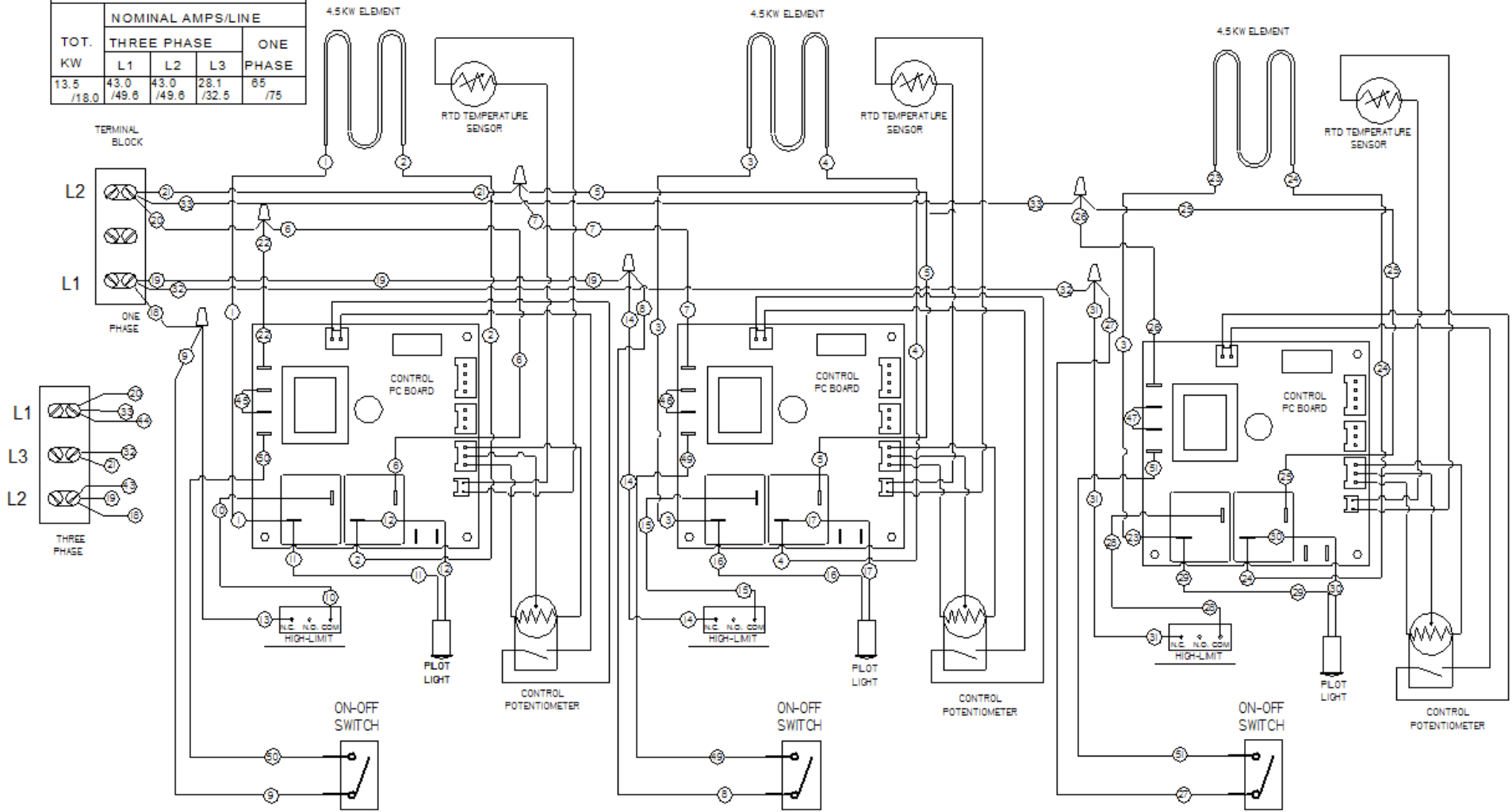

EG-48I VOLTS: 208/240 HZ: 50/60 PH: 1/3

MODEL EG-48H
 SERIAL NO. XXXXyymmxxx
 PART NO. 21823800
 VOLTS 208/240 Hz. 50/60 Ph. 1/3

TOT. KW	NOMINAL AMPS/LINE			ONE PHASE
	L1	L2	L3	
13.5	43.0	43.0	28.1	65
/18.0	/49.6	/49.6	/32.5	/75

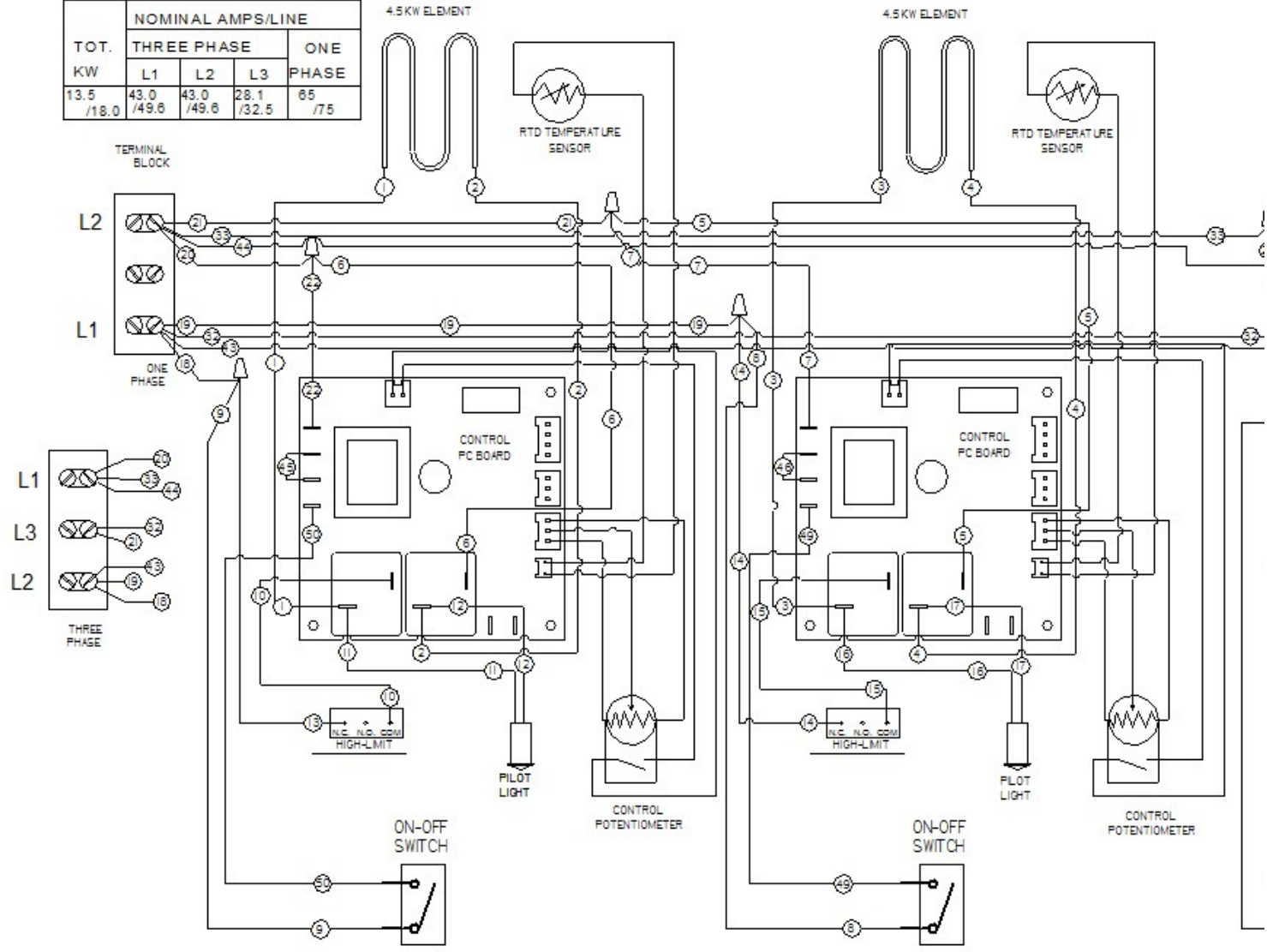

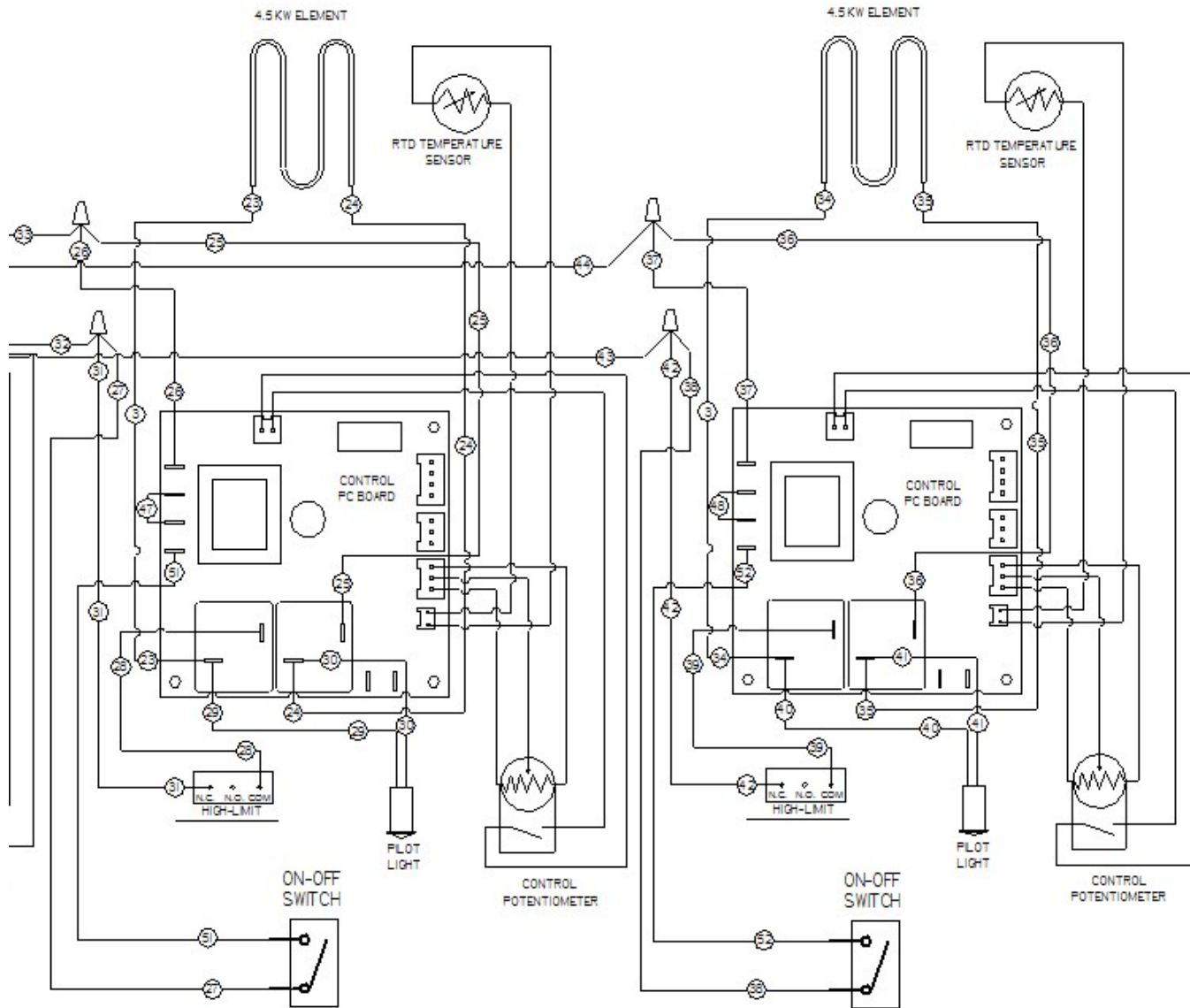

APW WYOTT EQUIPMENT LIMITED WARRANTY

APW Wyott Foodservice Equipment Company warrants its equipment against defects in materials and workmanship, subject to the following conditions:

This warranty applies to the original owner only and is not assignable.

Should any product fail to function in its intended manner under normal use within the limits defined in this warranty, at the option of APW Wyott such product will be repaired or replaced by APW Wyott or its Authorized Service Agency. APW Wyott will only be responsible for charges incurred or service performed by its Authorized Service Agencies. The use of other than APW Wyott Authorized Service Agencies will void this warranty and APW Wyott will not be responsible for such work or any charges associated with same. The closest APW Wyott Authorized Service Agent must be used.

This warranty covers products shipped into the 48 contiguous United States, Hawaii, metropolitan areas of Alaska and Canada. There will be no labor coverage for equipment located on any island not connected by roadway to the mainland.

Warranty coverage on products used outside the 48 contiguous United States, Hawaii, and metropolitan areas of Alaska and Canada may vary. Contact the international APW Wyott distributor, dealer, or service agency for details.

Time Period

One year for parts and one year for labor, effective from the date of purchase by the original owner. The Authorized Service Agency may, at their option, require proof of purchase. Parts replaced under this warranty are warranted for the un-expired portion of the original product warranty only.

Exceptions

- * **Gas/Electric Cookline:** Models GCB, GCRB, GF, GGM, GGT, CHP-H, EF, EG, EHP. Three (3) Year Warranty on all component parts, except switches and thermostats. (2 additional years on parts only. No labor on second or third year.)
- * **Broiler Briquettes, Rock Grates, Cooking Grates, Burner Shields, Fireboxes:** 90 Day Material Only. No Labor.
- * **Heat Strips:** Models FD, FDL, FDD, FDDL. Two (2) Year Warranty on element only. No labor second year.
- * **Glass Windows, Doors, Seals, Rubber Seals, Light Bulbs:** 90 Day Material Only. No Labor.

In all cases, parts covered by extended warranty will be shipped FOB the factory after the first year.

Portable Carry In Products

Equipment weighing over 70 pounds or permanently installed will be serviced on-site as per the terms of this warranty. Equipment weighing 70 pounds or under, and which is not permanently installed, i.e. with cord and plug, is considered portable and is subject to the following warranty handling limitations. If portable equipment fails to operate in its intended manner on the first day of connection, or use, at APW Wyott's option or its Authorized Service Agency, it will be serviced on site or replaced.

From day two through the conclusion of this warranty period, portable units must be taken to or sent prepaid to the APW Wyott Authorized Service Agency for in-warranty repairs. No mileage or travel charges are allowed on portable units after the first day of use. If the customer wants on-site service, they may receive same by paying the travel and mileage charges. Exceptions to this rule: (1) countertop warmers and cookers, which are covered under the Enhanced Warranty Program, and (2) toasters or rollergrills which have in store service.

Exclusions

The following conditions are not covered by warranty:

- * Equipment failure relating to improper installation, improper utility connection or supply and problems due to ventilation.
- * Equipment that has not been properly maintained, calibration of controls, adjustments, damage from improper cleaning and water damage to controls.
- * Equipment that has not been used in an appropriate manner, or has been subject to misuse or misapplication, neglect, abuse, accident, alteration, negligence, damage during transit, delivery or installation, fire, flood, riot or act of god.
- * Equipment that has the model number or serial number removed or altered.

If the equipment has been changed, altered, modified or repaired by other than an Authorized Service Agency during or after the warranty period, then the manufacturer shall not be liable for any damages to any person or to any property, which may result from the use of the equipment thereafter.

This warranty does not cover services performed at overtime or premium labor rates. Should service be required at times which normally involve overtime or premium labor rates, the owner shall be charged for the difference between normal service rates and such premium rates. APW Wyott does not assume any liability for extended delays in replacing or repairing any items beyond its control.

In all cases, the use of other than APW Wyott Authorized OEM Replacement Parts will void this warranty.

This equipment is intended for commercial use only. Warranty is void if equipment is installed in other than commercial application.

Water Quality Requirements

Water supply intended for a unit that has in excess of 3.0 grains of hardness per gallon (GPG) must be treated or softened before being used. Water containing over 3.0 GPG will decrease the efficiency and reduce the operation life of the unit.

Note: Product failure caused by liming or sediment buildup is not covered under warranty.

"THE FOREGOING WARRANTY IS IN LIEU OF ANY AND ALL OTHER WARRANTIES EXPRESSED OR IMPLIED INCLUDING ANY IMPLIED WARRANTY OF MERCHANTABILITY OR FITNESS FOR PARTICULAR PURPOSES AND CONSTITUTES THE ENTIRE LIABILITY OF APW WYOTT. IN NO EVENT DOES THE LIMITED WARRANTY EXTEND BEYOND THE TERMS STATED HEREIN."



24 Hour Toll Free



**Service Hot Line:
1-800-733-2203**

APW WYOTT Foodservice Equipment Company

P.O. Box 1829
Cheyenne, WY 82003

+1 (307) 634-5801 Phone
+1 (307) 637-8071 Fax

+1 (800) 752-0863 Toll Free
www.apwwyott.com

Free Manuals Download Website

<http://myh66.com>

<http://usermanuals.us>

<http://www.somanuals.com>

<http://www.4manuals.cc>

<http://www.manual-lib.com>

<http://www.404manual.com>

<http://www.luxmanual.com>

<http://aubethermostatmanual.com>

Golf course search by state

<http://golfingnear.com>

Email search by domain

<http://emailbydomain.com>

Auto manuals search

<http://auto.somanuals.com>

TV manuals search

<http://tv.somanuals.com>